

**PREBENA**®

Prebena Fastener Benelux bvba

# Promoties Promotions 2016-2017

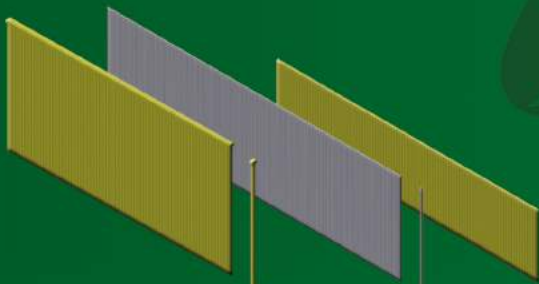

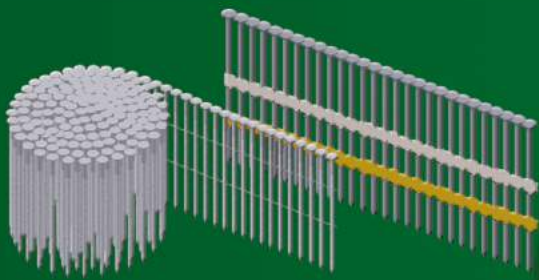
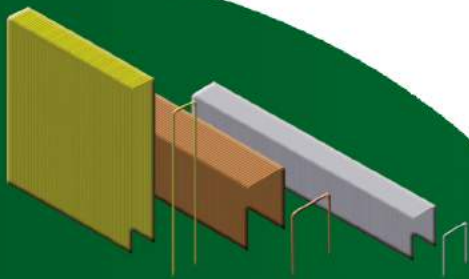

Certified by DIN EN ISO 9001:2008

TÜV certified production facilities

Proofed Safety Sign (GS sign)

CE- declaration for all pneumatic tools

Proofed fasteners as per DIN 1052:2008-12 with certificate for the construction side

CE-declaration for fasteners as per DIN EN 13964:2007-02

Member of the Fastener Association



**OPTIWEAR-  
TECHNOLOGY**



# PROMO

# PREBENA®

## 1. PISTOOL MINI-BRADS 2P-J50SDS

## CLOUEUSE MINI-BRADS 2P-J50SDS

€ 186,-



### TOEPASSINGEN

meubelindustrie, timmerfabriek, kistenindustrie, bouwindustrie, panelen

### APPLICATIONS

industrie du meuble, industrie du bois, constructions industrielles, panneaux

werkdruk: 5 - 7 bar

luchtverbruik: ca. 0,75 l

pression de travail: 5- 7 bar

consommation d'air comprimé: ca. 0,75l

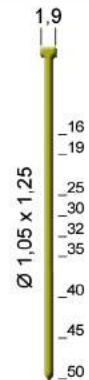

€258,72

3

€ 235,00

PRP-2P-J50SDSYS



+ GRATIS SYSTAINER GRATUIT

+ Met 35.000 mini-brads Avec 35.000 mini-brads

1 x J15CNKHA, J20CNKHA, J25CNKHA, J30CNKHA, J40CNKHA

## 2. PISTOOL BRADS 3C-N65-S

## CLOUEUSE BRADS 3C-N65-S

€ 301,-



### TOEPASSINGEN

sierlijstwerk, panelen, deuren en ramen, meubelindustrie, renovatie en bouw

### APPLICATIONS

panneaux, portes et chassis, industrie du meuble, rénovation et construction

werkdruk: 5 - 8 bar

luchtverbruik: ca. 0,8 l

pression de travail: 5- 8 bar

consommation d'air comprimé: ca. 0,8l

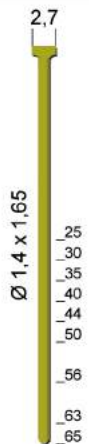

€383,00

3

€ 310,00

PRP-3C-N65SYS



+ GRATIS SYSTAINER GRATUIT

+ Met 17.500 brads Avec 17.500 brads

1 x N25CNKHA, N30CNKHA, N40CNKHA, N50CNKHA, N63CNKHA

## 3. NIETMACHINE 1GP-A16

## AGRAFEUSE 1GP-A16

€ 190,-



### TOEPASSINGEN

isolatie, stoffering, meubelindustrie, vloerbekleding, schoenindustrie

### APPLICATIONS

isolation, garnissage, industrie de meuble, pose de tapis, industrie de la chaussure

werkdruk: 4 - 7 bar

luchtverbruik: ca. 0,25 l

pression de travail: 4- 7 bar

consommation d'air comprimé: ca. 0,25l

Ook verkrijgbaar met lange neus

Aussi disponible avec nez longue

→p.4

OPTIWEAR-  
TECHNOLOGY

€201,03

3

€ 149,00

PRP-1GP-A16TAYG



+ GRATIS TAYG BOX GRATUIT

+ Met 16.000 nieten Avec 16.000 agrafes

1 x A12CNK, A14CNK, A16CNK

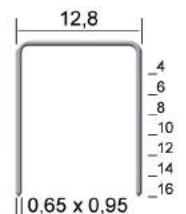

# PROMO

# PREBENA®

## 4. NIETMACHINE MET LANGE NEUS 1GP-A16LN50 AGRAFEUSE AVEC NEZ LONGUE 1GP-A16LN50 € 231,-



OPTIWEAR-  
TECHNOLOGY

**TOEPASSINGEN**  
isolatie, stoffering, meubelindustrie,  
vloerbekleding, schoenindustrie

**APPLICATIONS**  
isolation, garnissage, industrie de meuble,  
pose de tapis, industrie de la chaussure

**werkdruk: 4 - 7 bar**  
luchtverbruik: ca. 0,25 l

**pression de travail: 4- 7 bar**  
consommation d'air comprimé: ca. 0,25l

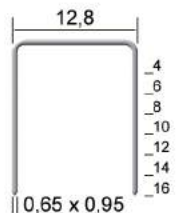

€242,03

3

**€ 205,00**

PRP-1GP-A16LN50TAYG



**+ GRATIS TAYG BOX GRATIS**  
**+ Met 16.000 nieten Avec 16.000 agrafes**

1 x A12CNK, A14CNK, A16CNK

## 5. COMBI MINI-BRADS & NIETEN 2P-J/ES40COMBI COMBI MINI-BRADS & AGRAFES 2P-J/ES40 € 208,-



**TOEPASSINGEN**  
meubelindustrie, timmerfabriek, kistenindustrie,  
bouwindustrie, panelen

**APPLICATIONS**  
industrie du meuble, industrie du bois, constructions  
industrielles, panneaux

**werkdruk: 5 - 7 bar**  
luchtverbruik: ca. 0,75 l

**pression de travail: 5- 7 bar**  
consommation d'air comprimé: ca. 0,75l

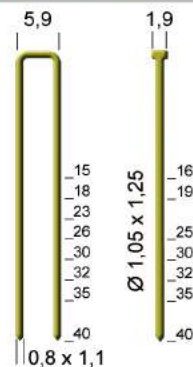

€283,59

3

**€ 255,00**

PRP-2P-J/ES40COMBISYS



**+ GRATIS SYSTAINER GRATIS**  
**+ Met 15.000 brads Avec 15.000 brads**  
1 x J25CNKHA, J30CNKHA, J40CNKHA  
**+ Met 6.000 nieten Avec 6.000 agrafes**  
1 x ES25CNKHA, ES40CNKHA

## 6. NIETMACHINE 2P-ES40SD AGRAFEUSE 2P-ES40SD € 218,-



**TOEPASSINGEN**  
meubelindustrie, timmerfabriek, kistenindustrie,  
bouwindustrie, panelen, ...

**APPLICATIONS**  
industrie du meuble, industrie du bois,  
constructions industrielle, panneaux, ....

**werkdruk: 5 - 7 bar**  
luchtverbruik: ca. 0,75 l

**pression de travail: 5- 7 bar**  
consommation d'air comprimé: ca. 0,75 l

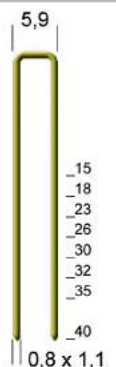

€283,59

3

**€ 255,00**

PRP-2P-ES40SYS



**+ GRATIS SYSTAINER GRATIS**  
**+ Met 20.800 nieten Avec 20.800 agrafes**  
1 x ES15CNKHA, ES23CNKHA, ES30CNKHA, ES40CNKHA

# PROMO

# PREBENA®

7. SEMI-PROFESIONELE SET MET MINI-BRAD EN NIETER

SET DIY AVEC MINI-BRAD ET AGRAFEUSE



+ GRATIS TAYG BOX **GRATUIT**

**Pistool mini-brads 2XR-J50**  
voor alle mini-brads tot 50mm  
**Nietmachine 1XR-A16**  
voor alle nieten type A tot 16mm

**Cloueuse mini-brads 2XR-J50**  
pour tout les mini-brads jusqu'à 50mm  
**Agrafeuse 1XR-A16**  
pour tous les agrafes type A jusqu'à 16mm

€ 152,00

PRP-XR-A16-J50TAYG

3

8. PROFESSIONELE SET MET MINI-BRAD EN NIETER

SET PROFESSIONNEL AVEC MINI-BRAD ET AGRAFEUSE



+ GRATIS TAYG BOX **GRATUIT**

**Pistool mini-brads 2P-J50SDS**  
voor alle mini-brads tot 50mm  
**Nietmachine 1GP-A16**  
voor alle nieten type A tot 16mm

**Cloueuse mini-brads 2P-J50SDS**  
pour tout les mini-brads jusqu'à 50mm  
**Agrafeuse 1GP-A16**  
pour tous les agrafes type A jusqu'à 16mm

€376,00

€ 299,00

PRP-PROF-A16-J50TAYG

3

9. SLAGHAMER HHPF01SET

MARTEAU AGRAFEUSE HHPF01SET

## TOEPASSINGEN

isolatie, plasticfolie, roofing en vochtisolatie

## APPLICATIONS

isolation, panneaux en plastique, papier à toiture et anti-humidité



slaghamer HHPF09-S19  
marteau agrafeuse HHPF09-S19

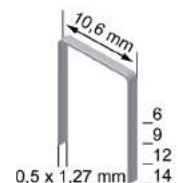

€210,00

€ 120,00

PRP-HHPF-01SET

3

In metalen koffer:

1 slaghamer HHPF09-S19  
12 dozen = 60.000 nieten type PF09CNK

En coffret en acier:

1 marteau agrafeuse HHPF09-S19  
12 boites = 60.000 agrafes type PF09CNK

# PROMO

# PREBENA®

## 10. NIETMACHINE 4C-Z50 AGRAFEUSE 4C-Z50

€ 419,-



### TOEPASSINGEN

panlatten, vloeren, paletten en kisten, meubelindustrie, plaatmaterialen, gyproc, pleistergaas

### APPLICATIONS

lattes à pannes, soles, palettes, caisses, industrie du meuble, panneaux, gyproc

werkdruk: 5 - 8 bar

luchtverbruik: ca. 1,7 l

pression de travail: 5- 8 bar

consommation d'air comprimé: ca. 1,7 l

Niet meegeleverd  
Pas inclus

Aanbevolen door  
Recommandé par

**xella**  
Neues Bauen

**fermacell**

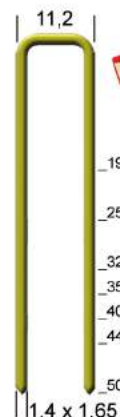

Geprüft nach  
DIN 1922:2008-12

Allgemeine bauaufsichtliche  
Zulassung  
Z-1-1-495

€695,40

3

€ 453,00

PRP-4C-Z50Z382



+ Met 22.200 nieten strong galv.

Avec 22.200 agrafes strong galv.

2 x Z38CSVHA

## 11. NIETMACHINE 4C-Z50 met SLIDEFIX AGRAFEUSE 4C-Z50 avec SLIDEFIX

€ 419,- + €365,-



### TOEPASSINGEN

panlatten, vloeren, paletten en kisten, meubelindustrie, plaatmaterialen, gyproc, pleistergaas

### APPLICATIONS

lattes à pannes, soles, palettes, caisses, industrie du meuble, panneaux, gyproc

werkdruk: 5 - 8 bar

luchtverbruik: ca. 1,7 l

pression de travail: 5- 8 bar

consommation d'air comprimé: ca. 1,7 l

Aanbevolen door  
Recommandé par

**xella**  
Neues Bauen

**fermacell**

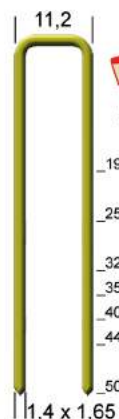

Geprüft nach  
DIN 1922:2008-12

Allgemeine bauaufsichtliche  
Zulassung  
Z-1-1-495

Rail te gebruiken met Festool en Mafell

Rail utilisable avec Festool et Mafell

€935,00

3

€ 675,00

PRP-4C-Z50SLIDER



+ Met 11.100 nieten DIV strong galv.

Avec 11.100 agrafes DIV strong galv.

1 x Z38DSV

## 12. NIETMACHINE 5C-Z75 AGRAFEUSE 5C-Z75

€ 699,-



### TOEPASSINGEN

panlatten, vloeren, paletten en kisten, meubelindustrie, plaatmaterialen, gyproc, pleistergaas

### APPLICATIONS

lattes à pannes, soles, palettes, caisses, industrie du meuble, panneaux, gyproc

werkdruk: 5 - 8 bar

luchtverbruik: ca. 2,3 l

pression de travail: 5- 8 bar

consommation d'air comprimé: ca. 2,3 l

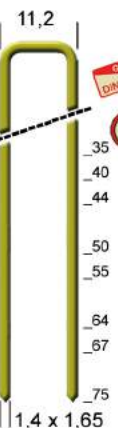

Geprüft nach  
DIN 1922:2008-12

Allgemeine bauaufsichtliche  
Zulassung  
Z-1-1-495

€934,70

3

€ 640,00

PRP-5C-Z75652



+ Met 12.000 nieten Avec 12.000 agrafes

2 x Z64CNKHA

# PROMO



## 13. NIETMACHINE 9X-WP160 AGRAFEUSE 9X-WP160

€ 1.171,-



**TOEPASSINGEN**  
zwaardere constructies, paletten, kisten, houten balken, daktimmerwerk

**APPLICATIONS**  
constructions plus lourdes, palettes, caisses, poutres en bois, charpentes en bois, constructions en bois, chaîne de fabrication

**werkdruk: 5 - 8 bar**  
**luchtverbruik: ca. 2,9 l**

pression de travail: 5 - 8 bar  
consommation d'air comprimé: ca. 2,9 l

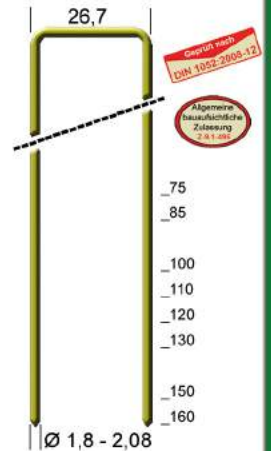

€1606,00 3  
**€ 1.170,00**  
PRP-9X-WP1604



**+ Met 4.400 nieten** Avec 4.400 agrafes  
2 x WP120CSVHA, WP160CSVHA

## 14. PISTOOL PINS 1GP-ALK35SYS CLOUEUSE PINS 1GP-ALK35SYS

€ 269,-



**TOEPASSINGEN**  
parket, fineerwerk, lijstwerk, hoekverbindingen

**APPLICATIONS**  
parquets, finitions, plinthes, reliures d'angle

**werkdruk: 5 - 6 bar**  
**luchtverbruik: ca. 0,35 l**

pression de travail: 5- 4 bar  
consommation d'air comprimé: ca. 0,35l

type ALK

type AL

0,65 x 0,95 mm

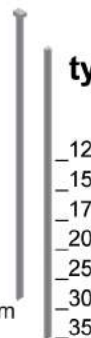

€320,00 3  
**€ 292,00**  
PRP-1GP-ALK35SYS



**+ GRATIS SYSTEMER GRATIS**  
**+ Met 30.000 pins** Avec 30.000 pins gratuit  
1 x AL20CLS, AL25CLS

## 15. PISTOOL MICO-BRADS 2F-JA45SYS CLOUEUSE MICRO-BRADS 2F-JA45SYS

€ 243,-



**TOEPASSINGEN**  
parket, fineerwerk, lijstwerk, hoekverbindingen

**APPLICATIONS**  
parquets, finitions, plinthes, reliures d'angle

**werkdruk: 4 - 7 bar**  
**luchtverbruik: ca. 0,3 l**

pression de travail: 4 - 7 bar  
consommation d'air comprimé: ca. 0,3l

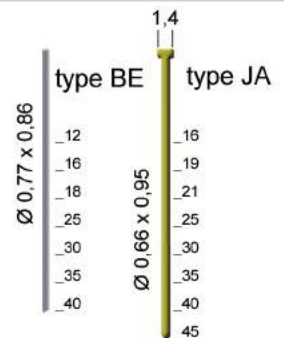

€283,50 3  
**€ 255,00**  
PRP-2F-JA45SYS



**+ GRATIS SYSTEMER GRATIS**  
**+ Met 30.000 pins** Avec 30.000 pins gratuit  
1 x BE21CLF, BE30CLF, JA30CNK

# PROMO

# PREBENA®

16. PISTOOL MINI-BRADS 2P-J50SVN

CLOUEUSE MINI BRADS 2P-J50SVN

€ 632,-



**TOEPASSINGEN**  
Speciaal voor glaslatten

**APPLICATIONS**  
Spécialement pour fenêtres

**werkdruk: 5 - 7 bar**  
**luchtverbruik: ca. 0,75 l**

**pression de travail: 5 - 7 bar**  
**consommation d'air comprimé: ca. 0,75 l**

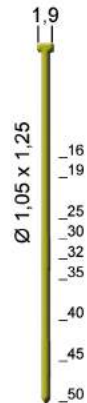
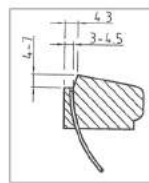
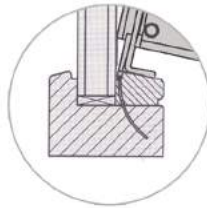

€632,00

3

**€ 562,00**

PRP-2P-J50SVN

17. PISTOOL DA-NAGELS 5X-DA63

CLOUEUSE A CLOUS DA 5X-DA63

€ 420,-



**TOEPASSINGEN**  
meubelindustrie, bouw, timmerfabriek,  
kistenindustrie, prefabbouw, renovatiebouw

**APPLICATIONS**  
industrie de meuble, construction, fabrication charpente,  
préfabrication, rénovation

**werkdruk: 5 - 8 bar**  
**luchtverbruik: ca. 1,4 l**

**pression de travail: 5- 8 bar**  
**consommation d'air comprimé: ca. 1,4 l**

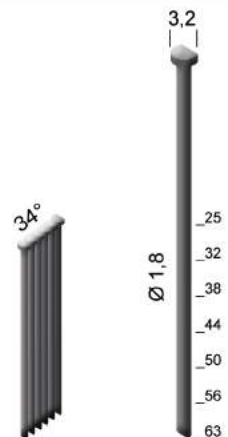

€663,29

3

**€ 420,00**

PRP-5X-DA6350631



**+ Met 20.000 DA nagels** Avec 20.000 clous DA  
1 x DA50CNKHA, DA63CNKHA

18. STRIPNAGELPISTOOL 6X-PR90

CLOUEUSE EN BANDES 6X-PR90

€ 476,-



**TOEPASSINGEN**  
zwaardere constructies, paletten, kisten  
houten balken, daktimmerwerk, houtbouw, systeembouw

**APPLICATIONS**  
constructions plus lourdes, palettes, caisses, poutres en bois,  
charpentes en bois, constructions en bois, chaîne de fabrication

**werkdruk: 4 - 8 bar**  
**luchtverbruik: ca. 2 l**

**pression de travail: 4 - 8 bar**  
**consommation d'air comprimé: ca. 2 l**

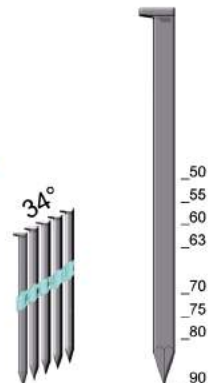

€893,40

3

**€ 565,00**

PRP-6X-PR90636



**+ Met 24.000 nagels** Avec 24.000 clous  
6 x PR28/63BK



## 19. STRIPNAGELPISTOOL 7Y-RK90 CLOUEUSE EN BANDES 7Y-RK90

€ 476,-



**TOEPASSINGEN**  
zwaardere constructies, paletten, kisten  
houten balken, daktimmerwerk, houtbouw, systeembouw

**APPLICATIONS**  
constructions plus lourdes, palettes, caisses, poutres en bois,  
charpentes en bois, constructions en bois, chaîne de fabrication

**werkdruk: 4 - 8 bar**  
**luchtverbruik: ca. 2 l**

pression de travail: 4 - 8 bar  
consommation d'air comprimé: ca. 2 l

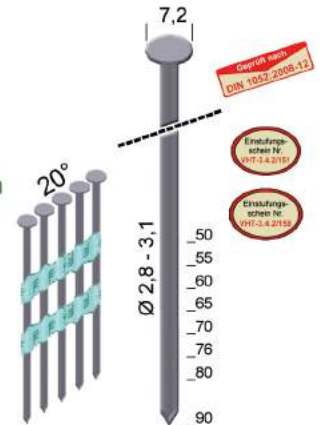

€905,28 3  
**€ 578,00**  
PRP-7Y-RK90658



**+ Met 24.000 nagels Avec 24.000 clous**  
8 x RK28/65BK

## 20. STRIPNAGELPISTOOL 10X-RK160 CLOUEUSE EN BANDES 10X-RK160

€ 951,-



**TOEPASSINGEN**  
zwaardere constructies, paletten, kisten  
houten balken, daktimmerwerk, houtbouw, systeembouw

**APPLICATIONS**  
constructions plus lourdes, palettes, caisses, poutres en bois,  
charpentes en bois, constructions en bois, chaîne de fabrication

**werkdruk: 6 - 8 bar**  
**luchtverbruik: ca. 4,9 l**

pression de travail: 6 - 8 bar  
consommation d'air comprimé: ca. 4,9 l

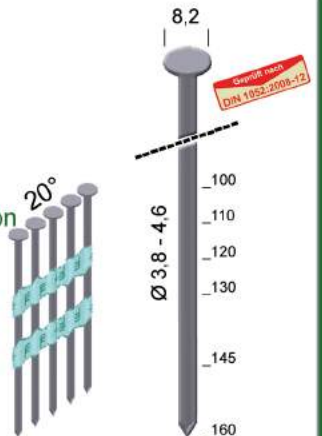

€1271,36 3  
**€ 940,00**  
PRP-10X-RK1604



**+ Met 3.800 nagels Avec 3.800 clous**  
2 x RK38/130BK, RK46/160BK

## 21. PISTOOL VOOR BAT-NAGELS ST2-ANK50 CLOUEUSE POUR DES FERRURES ST2-ANK50

€ 366,-



**TOEPASSINGEN**  
voor montage van balkdragers

**APPLICATIONS**  
pour montage de ferrures

**werkdruk: 7 - 8 bar**  
**luchtverbruik: ca. 3,3 l**

pression de travail: 7 - 8 bar  
consommation d'air comprimé: ca. 3,3 l

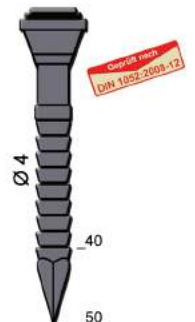
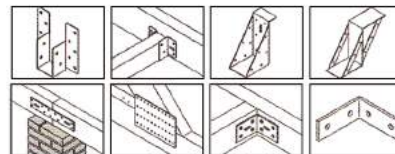

€551,00 3  
**€ 366,00**  
PRP-ST2-ANK50402



**+ Met 4.000 nagels Avec 4.000 clous**  
2 x ANK40/40NKRI

22. COILNAGELTOESTEL 3GP-CNH50 CLOUEUR A ROULEAUX 3GP-CNH50 €688,-



**TOEPASSINGEN**  
roofing en zinkwerk, sidings, gevelbekleding, leien, ...

**APPLICATIONS**  
couverture en roofing, zinc, shingles, ardoise, ...

**werkdruk: 5 - 8 bar**  
**luchtverbruik: ca. 2,4l**

**pression de travail: 5 - 8 bar**  
**consommation d'air: ca. 2,4l**



3  
**€ 647,00**  
PRP-3GP-CNH50

23. COIL NAGELPISTOOL 5F-CNW65-S CLOUEUSE A ROULEAU 5F-CNW65-S € 545,-



**TOEPASSINGEN**  
houtskeletbouw, vloeren, daken, kisten, kratten, palletindustrie, bouw- en timmerindustrie, sidings

**APPLICATIONS**  
constructions squelettique en bois, sols, toitures, caisses, palettes, sidings

**werkdruk: 5 - 8 bar**  
**luchtverbruik: ca. 2,2 l**

**pression de travail: 5 - 8 bar**  
**consommation d'air comprimé: ca. 2,2 l**

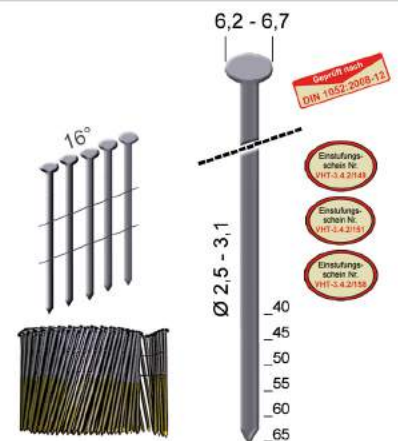

€827,50  
3  
**€ 608,00**  
PRP-5F-CNW65365



**+ Met 18.000 nagels Avec 18.000 clous**  
3 x CNW28/65BK

24. COIL NAGELPISTOOL 7F-CNW90 CLOUEUSE A ROULEAU 7F-CNW90 € 570,-



**TOEPASSINGEN**  
houtskeletbouw, vloeren, daken, kisten, kratten, palletindustrie, bouw- en timmerindustrie, sidings

**APPLICATIONS**  
constructions squelettique en bois, sols, toitures, caisses, palettes, sidings

**werkdruk: 5 - 8 bar**  
**luchtverbruik: ca. 2,2 l**

**pression de travail: 5 - 8 bar**  
**consommation d'air comprimé: ca. 2,2 l**

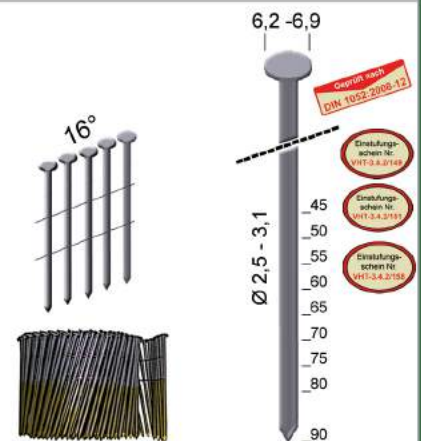

€806,70  
3  
**€ 619,00**  
PRP-7F-CNW90803



**+ Met 13.500 nagels Avec 13.500 clous**  
3 x CNW28/80BK

# PROMO

# PREBENA®

## 25. PALLET-PROMO-PALLET 5F-CNW65-S

90.000 nagels (15 x 6.000) 2,8x65mm  
90.000 clous (15 x 6.000) 2,8x65mm



+

Coilnageltoestel 5F-CNW65-S  
Cloueur a rouleaux 5F-CNW65-S



Coilnagels van 40 - 65mm  
Clous en rouleaux de 40 - 65mm  
326x135x346  
2,60kg - 5-8bar - 2,20 l

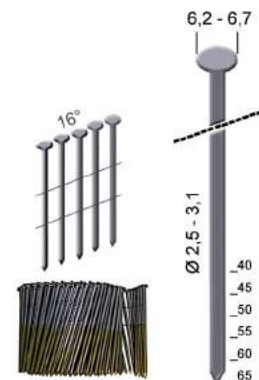

€ 1000,00  
PRP-PAL5F-CNW65

2

## 26. PALLET-PROMO-PALLET 7F-CNW90

67.500 nagels (15 x 4.500) 2,8x80mm  
67.500 clous (15 x 4.500) 2,8x80mm



+

Coilnageltoestel 7F-CNW90  
Cloueur a rouleaux 7F-CNW90



Coilnagels van 45 - 90mm  
Clous en rouleaux de 45 - 90mm  
388x140x366  
3,60kg - 5-8bar - 3,00 l

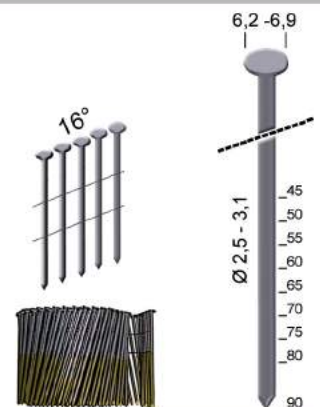

€ 1000,00  
PRP-PAL9F-CNW90

2

## 27. PALLET-PROMO-PALLET 6X-PR90

100.000 nagels (25 x 4.000) 2,8x63mm  
100.000 clous (25 x 4.000) 2,8x63mm



+

Stripnageltoestel 6X-PR90  
Stripnageltoestel 6X-PR90



Stripnagels van 45 - 90mm  
Clous en bandes de 45 - 90mm  
455x105x400  
3,10kg - 5-8bar - 2,47 l

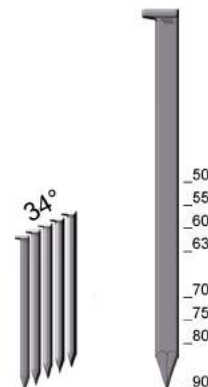

€ 1000,00  
PRP-PAL6X-PR90

2

# PROMO

28. MONTANA GASNAGELAAR GSN3490GAS

MONTANA CLOUEUR A GAZ GSN3490GAS

## TOEPASSINGEN

zwaardere constructies, paletten, kisten, houten balken, daktimmerwerk, houtbouw, systeembouw, ...

## APPLICATIONS

constructions plus lourdes, palettes caisses, poutres en bois, charpentes en bois, constructions en bois, chaîne de fabrications, ...

nagels van 50 - 90mm

clous de 50 - 90mm



€1.610,00 2  
**€ 999,00**  
PRP-PALGSN3490GAS

## PRIJZEN NAGELS MET GAS / PRIX CLOUS AVEC GAZ

2,8x50 glad/lisse	3320 nagels/clous	3xGAS	€50,20
2,8x50 ring/annelée	3320 nagels/clous	3xGAS	€52,71
2,8x63 glad/lisse	3320 nagels/clous	3xGAS	€54,90
2,8x63 ring/annelée	3320 nagels/clous	3xGAS	€57,65
2,8x75 glad/lisse	2200 nagels/clous	2xGAS	€39,82
2,8x75 ring/annelée	2200 nagels/clous	2xGAS	€41,90
2,8x80 glad/lisse	2200 nagels/clous	2xGAS	€40,90
2,8x80 ring/annelée	2200 nagels/clous	2xGAS	€42,95
3,1x90 glad/lisse	2200 nagels/clous	2xGAS	€48,62
3,1x90 ring/annelée	2200 nagels/clous	2xGAS	€51,05



4

29. PISTOOL SCHUINE BRADS DB15.64

MACHINE BRADS EN ANGLE DB15.64



## TOEPASSINGEN

meubelindustrie, timmerfabriek, kistenindustrie, bouwindustrie, panelen

## APPLICATIONS

industrie du meuble, industrie du bois, constructions industrielles, panneaux

werkdruk: 5 - 7 bar

luchtverbruik: ca. 0,75 l

pression de travail: 5- 7 bar

consommation d'air comprimé: ca. 0,75l

## DB15

1,60x1,85  
3,30

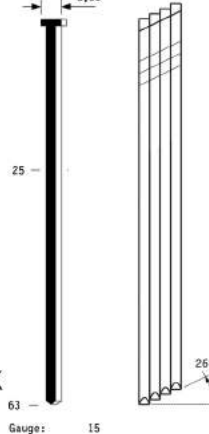

€776,00 3  
**€ 470,00**  
PRP-OMER-DB15.64



Met 29.240 brads type DB15

Avec 29.240 brads type DB15

14.620 x DB15/50NK, 14.620 x DB15/63NK

## 30. T-NAGELTOESTEL 5S-T65 CLOUEUR EN T 5S-T65

€408,-



### TOEPASSINGEN

panlatten, vloeren, palletten en kisten, meubelindustrie, plaatmaterialen, ...

### APPLICATIONS

lattes à pannes, soles, palettes, caisses, industrie du meuble, ...

werkdruk: 5 - 8 bar  
luchtverbruik: ca. 2,4l

pression de travail: 5 - 8 bar  
consommation d'air: ca. 2,4l

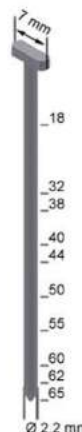

€735,60

3

€ 430,00

PRP-5S-T655065



**Met 20.000 T-nagels Avec 20.000 clous en T**  
10.000 x T22/50NK, 10.000 x T22/65NK

## 31. BANDSCHROEFMACHINE 8A-MGS55

## VISEUSE A BANDES 8A-MGS55

€695,-



Gewicht / poids: 2kg  
Batt: 18V, 3Ah, Li-ion  
RPM: 0-4.200/min  
Charge: 30min  
238 x 80 x 197mm

Geleverd in plastic koffer met:  
- toestel  
- 2 batterijen  
- snellader  
- 2 bits  
- adaptor voor enkele schroeven

Livré en coffre plastic inclus:  
- viseuse  
- 2 batteries  
- quick charger  
- 2 bits  
- adapteur pour vises

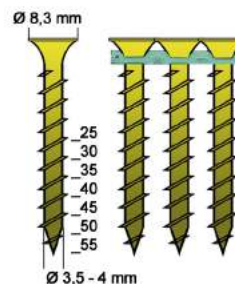

€876,20

2

€ 720,00

PRM-8A-MGS55



**Met 5.000 schroeven Avec 5.000 vises**  
5.000 x MGS4/35GGPH

Artikel / Article	box	prijs/box prix/box	Artikel / Article	box	prijs/box prix/box
MGS4/25GGPH	1.000	€11,52	MGS4/25GFPH	1.000	€12,27
MGS4/30GGPH	1.000	€12,53	MGS4/30GFPH	1.000	€13,59
MGS4/35GGPH	1.000	€13,76	MGS4/35GFPH	1.000	€14,23
MGS4/41GGPH	1.000	€15,88	MGS4/41GFPH	1.000	€17,21
MGS4/45GGPH	1.000	€17,21	MGS4/45GFPH	1.000	€17,21

MGS-GGPH		MGS-GFPH		MGS-GBPH		MGS-FMPH	
	Application Wood/Plasterboard		Application Metal/Plasterboard Max. 0,75 mm (0,03 in.)		Application Metal/Plasterboard Max. 2,25 mm (0,09 in.)		Application Metal/Fiber-board Max. 0,75 mm (0,03 in.) and Wood/Fiber-board
coarse thread		fine thread		drill point		hilo thread	

# PROMO



32. COMPRESSOR AEROTAINER 245

COMPRESSEUR AEROTAINER 245



€350,00 <sup>2</sup>  
**€ 245,00\***  
 PRP-AEROTAINER245

Volt./Hz	Lt.	L/min	L/min	bar	KW	rpm	Kg
230V	3	200	120	8	1100	2800	22

Pistool mini-brads 2P-J50SDS  
 voor alle minibrads tot 50mm  
 PERSLUCHTSLANG 10m  
 SYSTAINER

Cloueuse mini-brads 2P-J50SDS  
 toutes les mini-brads jusqu'à 50mm  
 TUYAUX de 10m  
 SYSTAINER

+



€540,40 <sup>2</sup>  
**€ 420,00**  
 PRP-AERO-2P-J50

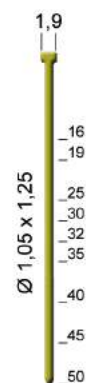

+

Pistool pins 1GP-ALK35  
 voor alle pins en micro-brads dia. 0,64 tot 35mm  
 PERSLUCHTSLANG 10m  
 SYSTAINER

Cloueuse pins 1GP-ALK35  
 toutes les pins et micro-brads dia. 0,64 jusqu'à 35mm  
 TUYAUX de 10m  
 SYSTAINER



€610,40 <sup>2</sup>  
**€ 454,00**  
 PRP-AERO-1GP-ALK35

type ALK

type AL

0,65 x 0,95 mm

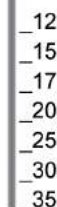

+

Pistool nieten 1GP-A16  
 voor alle nieten type A tot 16mm  
 PERSLUCHTSLANG 10m  
 SYSTAINER

Agrafeuse 1GP-A16  
 toutes les agrafes type A jusqu'à 16mm  
 TUYAUX de 10m  
 SYSTAINER



€544,40 <sup>2</sup>  
**€ 388,00**  
 PRP-AERO-1GP-A16

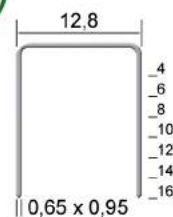

\* tot zolang de voorraad strekt / jusqu'à épuisement des stocks

# PROMO



## 33. COMPRESSOR VIGON 120 COMPRESSEUR VIGON 120

Volt./Hz	Lt.	L/min	L/min	bar	KW	rpm	Kg
230V	12	120	85	8	1,1	2850	18



+ **€338,00** <sup>2</sup>  
**€ 252,00**  
 PRP-VIGON120-1GP-A16

**Niettoestel 1GP-A16**  
 Agrafeuse 1GP-A16

+ **€368,40** <sup>2</sup>  
**€ 270,00**  
 PRP-VIGON120-2P-J/ES40COMBI

**Combi-toestel 2P-J/ES40COMBI**  
 Cloueur combi 2P-J/ES40COMBI

+ **€346,40** <sup>2</sup>  
**€ 270,00**  
 PRP-VIGON120-2P-J50

**Mini-brad toestel 2J-J50SDS**  
 Cloueur mini-brad 2P-J50SDS

## 34. PERSLUCHTSLANG OP ROL ENROULEURS



**Manueel  
 (met koppelingen)  
 à mains  
 (avec couplers)**

**€ 86,00** <sup>3</sup>  
 Z180.00



**Automatisch  
 Automatique**

**€ 131,00** <sup>3</sup>  
 SLANGHASPEL PRO

# PROMO



## 35. COMPRESSOR VIGON 120

## COMPRESSEUR VIGON 120



Volt./Hz	Lt.	L/min	L/min	bar	KW	rpm	Kg
230V	12	120	85	8	1100	2850	18



**Gemakkelijk mee te nemen**

Poignée de transport engommée



**Rubberen voet tegen trillingen**

Pied de caoutchouc pour une position stable



**Drukmanometer ketel drukregelaar**

Manomètre pour réservoir de pression. Réducteur pour la pression de travail

2

**€ 125,00**

PRM-VIGON120

## 36. COMPRESSOR VIGON 240

## COMPRESSEUR VIGON 240



Volt./Hz	Lt.	L/min	L/min	bar	KW	rpm	Kg
230V	24	240	160	8	1500	2850	26



**Gemakkelijk mee te nemen**

Poignée de transport engommée



**Robuuste transportwielen**

Roulettes de transport robustes



**Drukmanometer ketel drukregelaar**

Manomètre pour réservoir de pression. Réducteur pour la pression de travail

2

**€ 137,00**

PRM-VIGON240

## 37. COMPRESSOR VIGON 300

## COMPRESSEUR VIGON 300



Volt./Hz	Lt.	L/min	L/min	bar	KW	rpm	Kg
230V	50	300	190	9	1800	2850	35



**2 Handvaten maken het transport gemakkelijk**

Poignée de transport engommée poignée de transport supplémentaire



**Stevige opblaasbare wielen**

Roulettes de transport à l'air



**Drukmanometer ketel drukregelaar**

Manomètre pour réservoir de pression. Réducteur pour la pression de travail

2

**€ 196,00**

PRM-VIGON300



# PROMO



## 38. COMPRESSOR TWINSTAR 460

## COMPRESSEUR TWINSTAR 460



2

€ 735,00

PRM-TWINSTAR 460

Volt./Hz	Lt.	L/min	L/min	bar	KW	rpm	Kg
230V	50	410	285	10	2,2	1090	82

Drukschakelaar van hoge kwaliteit met overdrukventiel, overdrukventiel voor lage startdruk, overbelastingsbeveiliging, hoge bodemvrijheid, manometer voor keteldruk, gekeurde veiligheidsklep, drukregelaar met waterafscheider, stevige wielen, wateraflaat met kogelkraan, zwenkwielen, geen technische keuring nodig.

Interrupteur de pression avec sûreté de pression, protection moteur, garde au sol élevée, manomètre pour la pression du cuve, régulateur de pression avec séparateur d'eau, roues robustes, drainage de l'eau avec vanne à bille, pivotant, aucune inspection technique nécessaire.

830 x 470 x 825mm

## 39. COMPRESSOR TWINMAX 410

## COMPRESSEUR TWINMAX 410



2

€ 548,00

PRM-TWINMAX 410

Volt./Hz	Lt.	L/min	L/min	bar	KW	rpm	Kg
230V	50	360	195	10	2,2	1420	68

Drukschakelaar van hoge kwaliteit met overdrukventiel, overbelastingsbeveiliging, manometer voor keteldruk, gekeurde veiligheidsklep, drukregelaar, stevige wielen, wateraflaat met kogelkraan, rubberen handvat, grote ventilator voor optimale koeling, rubberen voetjes om trillingen te minimaliseren.

Interrupteur de pression avec sûreté de pression, protection moteur, manomètre pour la pression du cuve, régulateur de pression, roues robustes, drainage de l'eau avec vanne à bille, aucune inspection technique nécessaire, poignée en caoutchouc, grand ventilateur pour un refroidissement optimal.

820 x 440 x 750mm

## 40. COMPRESSOR VITAS45

## COMPRESSEUR VITAS45



72 dB

2

€ 199,00

PRM-VITAS45

Volt./Hz	Lt.	L/min	L/min	bar	KW	rpm	Kg
230V	4	41	24	10	0,25	2840	10



beschermde leidingen  
tubes protégées



makkelijk in transport  
facile à transporter



drukregelaar tot 10 bar  
régulateur du pression  
jusqu'à 10 bar

# PROMO



## 41. PISTOOL MINI-BRADS PKT-2-J50SD-S

## CLOUEUSE MINI-BRADS PKT-2-J50SD-S



**TOEPASSINGEN**  
meubelindustrie, timmerfabriek, kistenindustrie,  
bouwindustrie, panelen

**APPLICATIONS**  
industrie du meuble, industrie du bois, constructions  
industrielles, panneaux

**werkdruk: 5 - 7 bar**  
**luchtverbruik: ca. 0,75 l**

pression de travail: 5- 7 bar  
consommation d'air comprimé: ca. 0,75l

Werken met persluchtflës  
Travail avec bouteille d'air

2

**€ 398,00**

PRM-PKT-2-J50SD-S



**Koffer**  
**Pistool mini-brads**  
**Adaptor voor compressor**  
**Hervulbare persluchtflës**

Coffret  
Cloueuse mini-brads  
Adaptateur pour compresseur  
Bouteille rechargeable

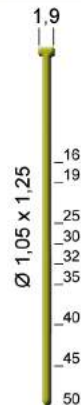

## 42. PERSLUCHT MOBILO

## PNEUMATIQUE MOBILO



Werken zonder compressor  
Travail à l'air comprimé sans  
compresseur

2

**€ 545,00**

PRM-PERSLUCHT MOBILO

**Meest mobiele perslucht-systeem**  
Le compresseur le plus mobile

**TOEPASSINGEN**  
Alle karwei voor gebruik van luchtdrukgeredschap

**APPLICATIONS**  
Tous les travaux à l'air comprimé...



**Hervulbare persluchtflës KT-3500**  
**HD-Ontspanner**  
**Spiraal slang**  
**Lederen gordel met kliksysteem**  
**in metalen koffer**  
**Gewicht: 3 kg**

Cartouche d'air comprimé  
KT-3500 rechargeable  
Contrôle HD  
Tuyau spirale  
Ceinture avec système « click »  
Coffret en metal  
Poids : 3 kg

## 43. TWINTEC 400 TWINTEC 400



Volt./Hz	bar	KW	rpm	Kg
230V	330	2,2	2760	65

**Vulstation voor de PREBENA flessen + gewone compressor (10 bar)**  
Pour les cartouches pneumatiques PREBENA + compresseur (10 bar)

**Vult 100l/min = 3x sneller dan Fillmaster 400**  
**Rempli 100l/min = 3 x plus vite que Fillmaster 400**

1

**€ 4250,00**

PRM-TWINTEC 400



# PROMO



44. NIETTOESTEL MET AFSTANDSGELEIDING 80.16D

AGRAFEUSE AVEC REGLAGE DE DISTANCE 80.16D €323,-



### TOEPASSINGEN

isolatie, stoffering, meubelindustrie,  
vloerbekleding, schoenindustrie

### APPLICATIONS

isolation, garnissage, industrie de meuble,  
pose de tapis, industrie de la chaussure

**werkdruk: 4 - 6 bar**

**luchtverbruik: ca. 0,13 l**

pression de travail: 4- 6 bar

consommation d'air comprimé: ca. 0,13 l

**MET AFSTANDSREGLING!!!**

**AVEC REGLAGE DE DISTANDE!!!**

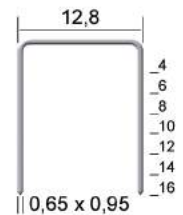

3

€ 304,00

OMER-80.16D

45. TOESTEL VOOR GLASLATTEN 12.40G

CLOUEUR POUR FENETRES 12.40G

€806,-

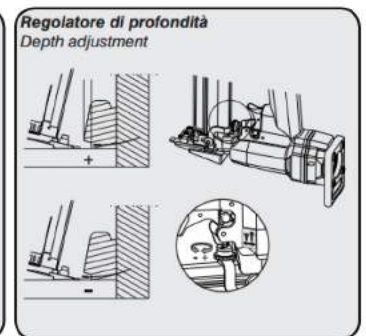
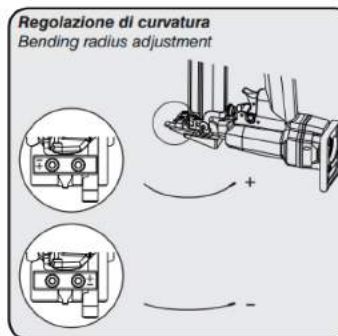
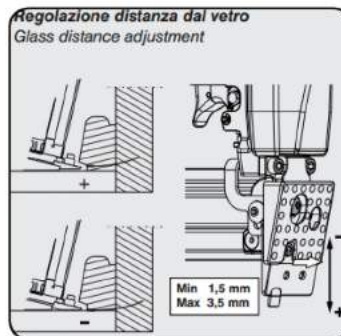

**werkdruk: 5 - 7 bar**

**luchtverbruik: ca. 0,34 l**

pression de travail: 5- 7 bar

consommation d'air comprimé: ca. 0,34 l

Voor mini-brads type J

Pour mini-brads type J

3

€ 760,00

OMER-12.40G

46. HOGGRINGS HR23-M8

HOGGRINGS HR23-M8

€730,-



### TOEPASSINGEN

autobekleding, beddenindustrie, ...

### APPLICATIONS

fixations grillages

**werkdruk: 5 - 7 bar**

**luchtverbruik: ca. 1,50 l**

pression de travail: 5 - 7 bar

consommation d'air comprimé: ca. 1,50 l

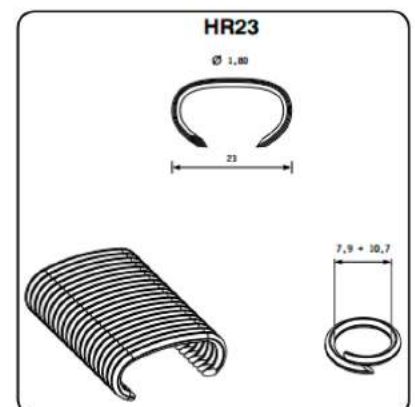

3

€ 682,00

OMER-HR23.M8

47. COILNAGELTOESTEL 5S-CNWS65

CLOUEUR A ROULEAUX 5S-CNWS65

€695,-



**NEW**

### TOEPASSINGEN

houtskeletbouw, kisten, kratten, bouw- en timmerindustrie, ...

### APPLICATIONS

constructions squelettiques en bois, charpentier, ...

werkdruk: 5 - 8 bar

luchtverbruik: ca. 1,87 l

pression de travail: 5- 8 bar

consommation d'air comprimé: ca. 1,87 l

- + CNP21/40RFRILI (8.400 st/pcs)
- + CNP21/45RFRILI (6.300 st/pcs)

RFRILI= inox, linsenkopf

€1244,00 3  
**€ 820,00**  
 PRP-5S-CNWS65CNP

- + CNPS25/30RF-T (3.600 st/pcs)

RF-T= inox, Torx15

€1254,00 3  
**€ 720,00**  
 PRP-5S-CNWS65CNPS30

- + CNPS25/45RF-T (3.600 st/pcs)
- + CNPS25/50NK-T (6.000 st/pcs)

RF-T= inox, Torx15 NK-T= galva, Torx15

€1210,00 3  
**€ 770,00**  
 PRP-5S-CNWS65CNPS4550

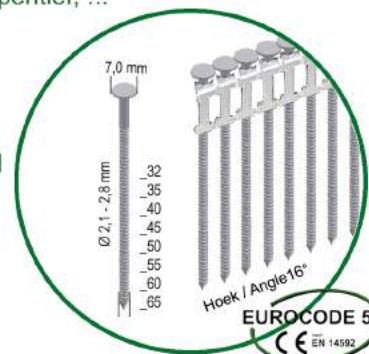

**Coilnails CNP**  
 plastic collated - sheet bounded  
 for residue-free processing

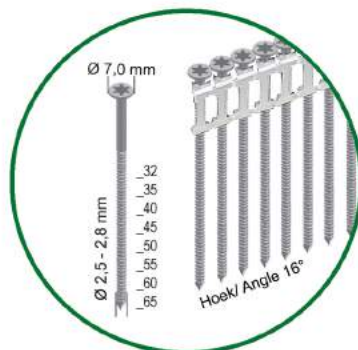

**Nail screws CNPS**  
 plastic collated - sheet bounded  
 for residue-free processing

**PREBENA®**

**PREBENA Fastener Benelux**

Capucienelaan 2  
 9300 Aalst / Belgium

info@prebenafb.com  
 www.prebenafb.com