

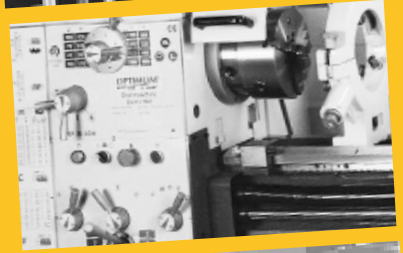



























TOOLS
EQUIPMENT
MACHINES



CATALOGUS

2016 - 2017

<p>GEREEDSCHAPSKOFFERS & -WAGENS P. 52 - 61</p> <p>TENGOOLS</p>						
<p>GEREEDSCHAPSETS P. 62 - 95</p> <p>TENGOOLS</p>						
<p>GEREEDSCHAP IN TRAYS P. 96 - 125</p> <p>TENGOOLS</p>						
<p>DOPPEN & ACCESSOIRES P. 126 - 147</p> <p>TENGOOLS</p>						
<p>DOPPENSETS P. 148 - 165</p> <p>TENGOOLS</p>						
<p>SLEUTELS P. 166 - 189</p> <p>TENGOOLS</p>						
<p>SCHROEVENDRAAIERS & BITSEN P. 190 - 207</p> <p>TENGOOLS  </p>						
<p>MOMENTSLEUTELS P. 208 - 215</p> <p>TENGOOLS</p>						
<p>TANGEN P. 216 - 227</p> <p>TENGOOLS</p>						
<p>KABELSCHOENTANGEN P. 228 - 231</p> <p>TENGOOLS  </p>						
<p>RIVETEERTANGEN P. 232 - 235</p> <p>TENGOOLS  </p>						
<p>POULIETREKKERS P. 236 - 239</p> <p>TENGOOLS  </p>						
<p>SLAGGEREEDSCHAP P. 242 - 249</p> <p>TENGOOLS</p>						
<p>SNIJ- & VIJLGEREEDSCHAP P. 252 - 258</p> <p>TENGOOLS</p>						
<p>PROMOTIEMATERIAAL P. 259 - 259</p> <p>TENGOOLS</p>						
<p>PICKUP- & AUTOTOOLS P. 262 - 269</p> <p>TENGOOLS  </p>						

GEREEDSCHAP MW TOOLS

P. 270 - 289

TOOLS

**MEETGEREEDSCHAP**

P. 290 - 345

TENGTOOLS

**SLANGKLEMMEN**

P. 346 - 351

**VERLICHTINGSMATERIAAL**

P. 352 - 355

TOOLS TENGTOOLS

**HOOFDBESCHERMING**

P. 356 - 358

MACH TELWIN

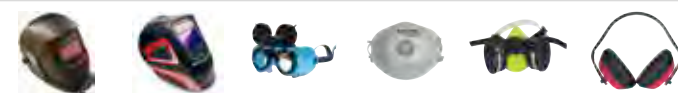
**VOETBESCHERMING**

P. 359 - 363

**TRANSPORTMATERIAAL**

P. 364 - 375

TOOLS UNICRAFT

**OPRIJPLATEN**

P. 376 - 397

TOOLS

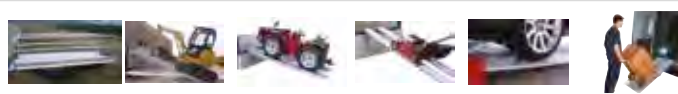
**HIJSMATERIAAL**

P. 398 - 407

TOOLS SUPERWINCH UNICRAFT

**BEVESTIGINGSMATERIAAL**

P. 408 - 410

TOOLS TENGTOOLS

**MECHANISCHE WERKPLAATSUITRUSTING**

P. 412 - 427

TOOLS

**HYDRAULISCHE WERKPLAATSUITRUSTING**

P. 428 - 435

TOOLS

**REINIGINGSTOESTELLEN**

P. 436 - 457

TOOLS MACH ZETORCRAFT

**SIGNALISATIE & VEILIGHEID**

P. 458 - 473

TOOLS STANLEY

**MILIEUVOORZIENINGEN**

P. 474 - 479

TOOLS







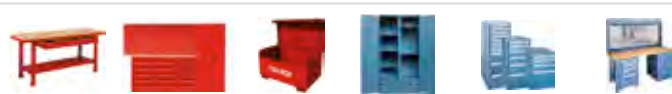



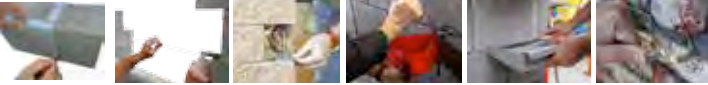



**WERKPLAATSMEUBILAIR**





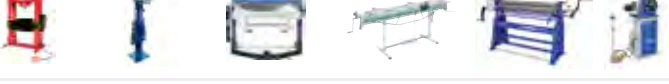

P. 480 - 601

TOOLS BUILD HECO TENGTOOLS



INDEX

<p>LUCHTDRIJKEREEDSCHAP P. 602 - 619</p> <p><i>aircraft</i></p>	
<p>BOUWWERKTUIGEN P. 620 - 623</p> <p>BUILD</p>	
<p>BOUWDROGERS P. 624 - 625</p> <p>BUILD</p>	
<p>WATERPOMPEN P. 626 - 627</p> <p>MACH</p>	
<p>TRILPLATEN P. 628 - 629</p> <p>BUILD</p>	
<p>COMPRESSOREN P. 630 - 665</p> <p><i>aircraft</i></p>	
<p>HOUTBEWERKINGSMACHINES P. 666 - 707</p> <p><i>holzstar</i> <i>holzkräft</i></p>	
<p>GENERATOREN P. 708 - 711</p> <p><i>aircraft</i> STANLEY</p>	
<p>VERWARMINGSTOESTELLEN P. 712 - 731</p> <p><i>PROTEMP</i> STANLEY ISEE MACH</p>	
<p>BATTERIJLADERS P. 732 - 749</p> <p>TEUW MACH</p>	
<p>LASTOESTELLEN P. 750 - 793</p> <p>TEUW MACH</p>	
<p>SNIJ- & PLOOIMACHINES P. 794 - 853</p> <p><i>OPTIMUM</i> <i>metallkraft</i> TOOLS <i>JOLIANEL</i></p>	
<p>SLIJPMACHINES P. 856 - 875</p> <p><i>OPTIMUM</i> <i>metallkraft</i> MACH</p>	
<p>ZAAGMACHINES P. 878 - 935</p> <p><i>OPTIMUM</i> <i>metallkraft</i> MACH</p>	
<p>BOORMACHINES P. 936 - 997</p> <p><i>OPTIMUM</i> <i>metallkraft</i></p>	
<p>PNEUMATISCHE TAPARMEN P. 998 - 998</p> <p>TOOLS</p>	

BOOR-FREESMACHINES P. 999 - 1023 	
DRAAIBANKEN P. 1024 - 1063 	
CNC GESTUURDE MACHINES P. 1064 - 1075 	
DIGITAAL METEN OP MACHINES P. 1076 - 1077 	
VEILIGHEIDSAFSCHEMING OP MACHINES P. 1078 - 1085 	
KLEM- & OPSPANGEREEDSCHAP P. 1086 - 1099  	
WERKSTUKKLEMMING P. 1100 - 1107  	
MACHINEVERLICHTING P. 1108 - 1109 	
TAPPEN & KUSSENS P. 1110 - 1116 	
KOTTERGEREEDSCHAP P. 1117 - 1117 	
MACHINEUITRUSTING P. 1118 - 1119  	
FREZEN- & BEITELSETS P. 1120 - 1131  	
KOELING & OLIËN P. 1132 - 1135   	
BOREN P. 1136 - 1151   	
ZAAGBLADEN & KLOKZAGEN P. 1152 - 1165  	
SCHURBANDEN & -SCHIJVEN P. 1166 - 1172   	

PRODUCTEN

Tools
Equipment
Machines

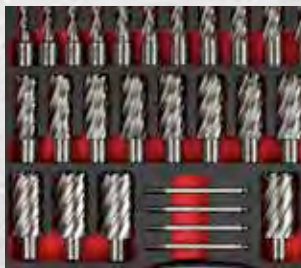

SERVICE

Klantendienst

Onze klantendienst gaat voor u tot het uiterste. We zetten ons iedere dag voor u in en proberen u zo snel mogelijk een antwoord te geven op uw vragen. We staan u bij op technisch en administratief vlak en adviseren u bij de keuze van uw producten, zodat onze samenwerking verder positief kan worden uitgebouwd.



Dienst-na-verkoop

- Technische ondersteuning: Onze Profit Centers maken gebruik van een sterke dienst-na-verkoop die alle technische ondersteuning biedt. Ons atelier werd in 2013 gevoelig uitgebreid naar meer dan 3000 m². De VYNCKIER techniekers genieten een permanente vorming, om u de beste service te kunnen bieden.
- Handleidingen & wisselstukken: Om een handleiding te downloaden, navigeer naar het desbetreffende product in de online catalogus. U vindt de handleiding op diezelfde pagina.
- RMA-Document: Voor een vlotte en correcte afhandeling van de servicedossiers hebben wij een RMA document ontwikkeld. Wij vragen u dit document goed door te nemen en de voor u nodige stappen te ondernemen.

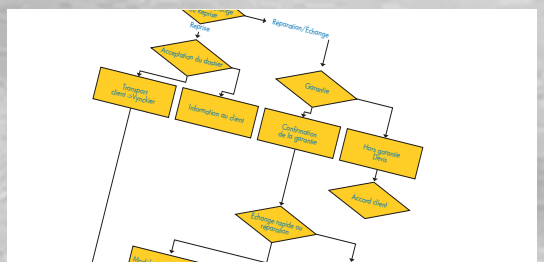

LOGISTIEK

Snelle levering

Meer dan 120.000 artikelen worden gestockeerd, en verdeeld via ons Benelux en Europees magazijn naar de Europese markt. Dankzij de distributiepartners, kan VYNCKIER een 24u levertijd garanderen in de Benelux markt en een 72u levertijd naar de Europese markt. Onze producten worden uitsluitend verdeeld via een netwerk van professionele dealers. Deze garanderen een persoonlijk contact en een professionele service in de volledige Benelux!



Patrick Wagnonlaan 7 - B-7700 Moeskroen - tel. +32 56 56 14 66 - fax +32 56 56 14 68 - info@vynckier.biz



ACADEMY

Opleiding op maat

VYNCKIER investeert in opleiding niet enkel voor eigen personeel, maar ook voor zijn verdelers. Wij zijn ervan overtuigd dat een erkende VYNCKIER verdeler de eindklant op een professionele manier uitleg en technische ondersteuning moet kunnen geven. Daarom heeft VYNCKIER opleidingen ontwikkeld die zowel het accent leggen op een doorgedreven productkennis alsook op de manier waarop een verdeler zijn klanten vakkundig kan bijstaan en voorlichten.

SPONSORING

Husqvarna-Rockstar JM Racing Team

Het JM Racing Team, onder leiding van Jacky Martens, is de technische partner voor de Europese activiteiten van het Husqvarna-Rockstar motorcross team. Ook zij kozen voor Teng Tools!
Meer info op www.jmracing.mx.

Teng Tools Masters

Actief in de autosport, motorsport, motorbootsport,...? Sleutel je vaak aan je wagen, motor, boot, ... om op elke wedstrijd tip-top in orde aan de start te komen? Dan weet je hoe belangrijk goede tools zijn. Maak keuze uit onze Teng Tools sponsor packs. Bovendien rusten we je team gratis uit met T-shirts, petjes, vlaggen, ...
Meer info op tengtoolsmasters.com.



MARKETING

Marketing

Onze marketingdienst werkt constant aan de verfijning van de digitale catalogus. Dit garandeert altijd de meest recente productinformatie. Daarnaast wordt om de 2 jaar een gedrukte versie van de VYNCKIER catalogus verspreid in de Benelux. De oplage van meer dan 40.000 stuks wordt in samenwerking met, en gepersonaliseerd op maat van geselecteerde verdelers ontworpen.



WEBSITE

Vynckier.biz

Onze website wordt dagelijks geüpdated met de meest recente productinformatie en prijzen. Eindgebruikers kunnen via de website eveneens een VYNCKIER dealer zoeken.

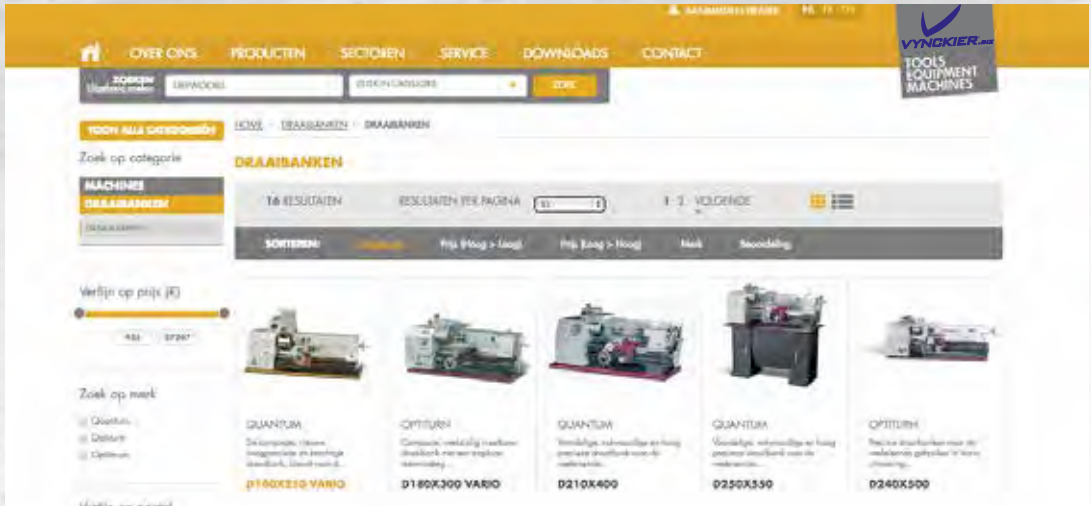

V-BUSINESS

V-Business

Via V-Business hebben VYNCKIER dealers toegang tot business to business informatie, en een reeks handige tools. Zo kan men online bestellingen plaatsen op een snelle en zeer gebruiksvriendelijke manier. Men kan ook alle openstaande orders en lopende herstellingen opvolgen. Het is ook mogelijk om steeds up-to-date stock te raadplegen en handleidingen te downloaden.

Nearly New

Op Vbusiness vindt u ook Nearly New artikelen. Deze bevatten zowel artikelen uit het huidige gamma als ook eindreeksen. Ze worden aangeboden omdat we niet langer over de originele verpakking beschikken, er lichte transportschade is ontstaan, het een demo model betreft of omdat er lichte schade is. Ook tweedehands artikelen kunt u hieronder terugvinden. Deze kleine tekortkomingen worden gecompenseerd onder de vorm van een extra korting. De garantietermijn is dezelfde zoals in de verkoopsvoorwaarden van VYNCKIER vermeld, tenzij anders aangegeven.



LEVERINGSVOORWAARDEN

Deze catalogus vervangt alle voorgaande. Al onze prijzen zijn in euro en exclusief BTW, Bebat, Recupel, Valipac en Verwijderingsbijdrage. Alle leveringen gebeuren uitsluitend volgens onze algemene verkoops-, leverings- en betalingsvoorwaarden welke op simpele aanvraag, aan ons adres, gratis te verkrijgen zijn. VYNCKIER houdt zich het recht voor om prijzen en/of specificaties van producten aan te passen. De afbeeldingen zijn louter indicatief, de producten kunnen afwijken van de in de catalogus vermelde afbeeldingen.

Garantievoorwaarden en retourprocedure:

De geldende garantievoorwaarden en retourprocedure kunnen worden geraadpleegd en gedownload via onze website: www.vynckier.biz/nl/service/rma-document.

Alle RMA (Returneren Met Autorisatie) aanvragen worden doorgestuurd naar emailadres service@vynckier.biz of naar faxnummer +32 56 56 14 68. Dit document voor aanvraag is te vinden op www.vynckier.biz/nl/service/rma-document. Daarna ontvangt u van de dienst na verkoop een dossiernummer. Dit dossiernummer dient steeds vergezeld te zijn van de retourgoederen en de verkoopfactuur.

Betaling & eigendomsvoorbehoud:

Al onze facturen zijn contant betaalbaar. De goederen blijven eigendom van VYNCKIER zolang de goederen niet betaald zijn.

Transportkosten:

De goederen reizen op risico van de koper. De berekende vrachtkosten zijn een doorrekening van de geldende transportkosten van GLS, Parts Express, DHL, ... Goederen worden franco ONGELOST geleverd vanaf 400 euro in de Benelux, vanaf 600 euro voor Noord-Frankrijk.

De machineprijzen (> 400 euro) zijn prijzen inclusief transport ONGELOST tot bij de doorverkoper. Anonieme levering van grote machines direct bij de eindklant is mogelijk. Onze prijzen zijn franco levering, ongelost en exclusief installatie. Installatie en inbedrijfstelling gebeuren door de doorverkoper. De installatie en de inbedrijfstelling kunnen ook door VYNCKIER uitgevoerd worden op vraag van de doorverkoper en tegen de vooraf afgesproken voorwaarden. Hiervoor dient contact te worden opgenomen met onze commerciële dienst.

Technische specificaties:

Gezien VYNCKIER voortdurend streeft om zijn producten te verbeteren, behoudt VYNCKIER zich het recht om de producten zonder voorafgaande vermelding te wijzigen. Goederen die uit collectie genomen worden gedurende de looptijd van deze catalogus kunnen geen aanleiding geven tot enige vorm van schadevergoeding of compensatie.

Waarborg:

Op alle VYNCKIER artikelen is 100% garantie op gebrekkelijk materiaal en/of gebrekkige afwerking. Garantie vervalt bij ondeskundig gebruik en/of gebruik van het product voor andere doeleinden of op een andere wijze aan waarvoor zij bestemd zijn.

Leveringstermijnen:

Leveringstermijnen voorzien op de bestelbon of op offertes gelden slechts als aanduiding en verbinden geenszins de verkoper.

De koper kan in geen geval de ontbinding van de overeenkomst, noch schadevergoeding vorderen bij niet-naleving van de leveringstermijn.

Belangrijk!

Tekort of schade bij levering in België/Luxemburg:

Controleer de goederen op transportschade vóór u de vrachtdocumenten ondertekent in het bijzijn van de transporteur. Doe dit ook wanneer de verpakking niet beschadigd is.

1. Bij zichtbare schade vermeldt u de schade onmiddellijk gedetailleerd op de vrachtbrief en laat u deze ondertekenen door de chauffeur. Indien u de vrachtbrief ondertekent zonder opmerkingen kan in geen geval bij de transportverzekering nadien nog een schadeclaim worden ingediend.

Neem vervolgens onmiddellijk contact op met VYNCKIER om de schade te regelen (info@vynckier.biz of +32 56 56 14 66).

2. In alle andere gevallen tekent u de vrachtbrief af onder voorbehoud van verder nazicht.

Dit voorbehoud geeft u de mogelijkheid om nadien een schadeclaim in te dienen in geval van onzichtbare schade. Deze claim dient binnen de 5 kalenderdagen schriftelijk te worden gemeld bij VYNCKIER. 5 kalenderdagen na de levering worden geen klachten meer aanvaard.

Dit voorbehoud dient ook te gebeuren in geval van digitale ondertekening van de vrachtbrief.

Tekort of schade bij levering in Nederland:

Controleer de goederen op transportschade vóór u de vrachtdocumenten ondertekent in het bijzijn van de transporteur. Doe dit ook wanneer de verpakking niet beschadigd is.

1. Bij zichtbare schade vermeldt u de schade onmiddellijk gedetailleerd op de vrachtbrief en laat u deze ondertekenen door de chauffeur. Indien u de vrachtbrief ondertekent zonder opmerkingen kan in geen geval bij de transportverzekering nadien nog een schadeclaim worden ingediend. Bij zichtbare schade kan u de zending weigeren.

Neem vervolgens onmiddellijk contact op met VYNCKIER om de schade te regelen (info@vynckier.biz of +32 56 56 14 66).

2. In alle andere gevallen dient een klacht binnen de 5 kalenderdagen schriftelijk gemeld te worden aan VYNCKIER met vermelding van de algemene aard van de schade of het verlies. 5 kalenderdagen na de levering worden geen klachten meer aanvaard.

Belangrijk!

Deze catalogus wordt na 2 jaar vervangen door een nieuwe editie. De vermelde prijzen kunnen echter geen 2 jaar gegarandeerd worden, en zijn dus indicatief. Gezien de koersschommelingen is VYNCKIER buiten zijn wil om genoodzaakt om de prijzen tussentijds te updaten.

ALFABETISCHE INDEX

A		Afstandshouders	774, 775
Aambeelden	242	Afstandsmeters	301
Aandammers	628, 629	Afsteekbeitelhouders	1096, 1097
Aanloopschakelaars	702	Afsteekplaatjes	1126, 1127, 1128, 1129, 1130, 1131
Aardingsklemmen	749, 770	Aftekenaars	330
Absorptiedoeken	474	Afzetbanden	460, 461, 462, 463
Absorptiemateriaal	474	Afzellint	460, 461, 462, 463
Accessoires batterijladers	749	Afzetpalen	460, 461, 462, 463, 464, 465, 467
Accessoires boorfreesmachines	1118, 1119	Afzetting	460, 461, 462, 463
Accessoires draaibanken	1119	Afzuigkits	703, 704
Accessoires houtbewerkingsmachines	668, 669, 674, 676, 677, 679, 681, 683, 685, 687, 690, 692, 693, 694, 700, 701, 702, 703, 704, 706, 1168, 1170, 1172	Aircontrol units	664, 665
Accessoires lasapparaten	754, 759, 760, 761, 764, 765, 768, 774, 775, 778	Allensleutels	107, 124, 183, 184, 185, 187
Accessoires MIG-MAG lasapparaten	759, 760, 761	Ampèremeters	292, 293, 294, 296, 297, 310
Accessoires MMA lasapparaten	754	Analoge meetklokken	322, 323
Accessoires paneelzaagmachines	668, 669, 674, 676, 677, 679, 681, 685, 687, 693, 700, 701, 702, 703, 704, 706, 1168, 1170	Anti-Stick spray	770
Accessoires plasma branders	774, 775	Anti-vermoeidheidsmatten	458, 459
Accessoires plooiomachines	802, 808, 809, 810, 823, 825, 827, 831, 839, 869	Armen met elektrodes	778
Accessoires popnageltangen	235	Assteunen	419
Accessoires poulietrekkers	239	Autodeuksets	432
Accessoires puntlasapparaten	778	Autogene lasapparaten	772
Accessoires riveteertangen	235	Autohefbruggen	370, 371, 372
Accessoires snelstarters	740, 748, 749	Autokriks	428, 429, 430
Accessoires snijmachines	802, 808, 809, 810, 823, 825, 827, 831, 839, 869	Autolieren	398, 399, 400, 401, 402
Accessoires voor takels	398, 399, 400, 401, 402, 403, 404, 405, 406, 407	Automatische kabelhaspels	414, 415, 416, 417, 418
Accessoires zandstraalcabines	447, 448, 449, 450, 451, 452	Automatische voeding	1118
Accessoires batterijladers	748	Automotive tools	114, 115, 262, 263, 264, 265, 268
Accucheck	747	Autotools	262
Acculaders	736, 737, 738, 739, 740, 741, 742, 743, 744, 745, 746, 747, 748	B	
Accutesters	745, 747	Bagetten lasapparaten	752, 753, 754, 781, 782, 783
Adapters voor kernboren	1089, 1090	Bakjeskasten	492, 493
Adaptors	131	Band- en schijfschuurmachines	864, 866, 867, 868, 870
Ademhalingsbescherming	357, 358	Bandenblazers	605, 606
Afbakening	460, 461, 462, 463	Bandenprofielometers	316
Afbreekmessen	116, 253, 254	Bandschuurmachines	864, 865, 867, 868, 870
Afkortzaagmachines	878, 879, 880, 881, 882, 883, 884, 885, 886, 887	Bandzagen	889, 890, 891, 892, 893, 894, 895, 896, 898, 904, 906, 910, 912, 914, 916, 920, 924
Afscherming	460, 461, 462, 463	Bankhamers	245
Afscherming T-gleuven	1119	Bankschroeven	1100
Afsluiting	460, 461, 462, 463, 464, 465, 466, 467	Bankvijzen	1100, 1101, 1102, 1103, 1104, 1105, 1106, 1107
Afsluitkettingen	462	Basis gecoate laselektrodes	766
		Batterijladers	736, 737, 738, 741, 742, 743, 744, 745, 746, 747, 748, 749
		Batterijladers-starters	742, 743
		Batterijtesters	747
		Beitelhamer	613
		Beitelhamers	613

Beitels	242, 1120, 1121, 1122, 1123, 1124, 1125, 1126, 1127, 1128, 1129, 1131
Beitelssets met hard metalen wisselplaatjes	1122, 1123, 1124
Bekken voor bankschroeven	1100
Bektangen	219, 220, 221
Beschermbecken voor bankschroeven	1100
Beschermfolie zandstraalcabines	452
Bescherming boormachines	1080, 1081
Bescherming draaibank	1082, 1083, 1084
Bescherming freesmachines	1085
Bescherming metaalbewerking	1080, 1081, 1082, 1083, 1084, 1085
Bescherming tegen lasspatten	771
Bescherming T-gleuven	1119
Beschermingslatten voor T-gleuven	1119
Beschermerschoenen	360, 361, 363
Betonijzerscharen	807
Betonijzertangen	219
Beugelzagen	252
Bevestigingsmateriaal	408, 409, 410
Bevestigingsrails	408, 409
Bewakingsspiegels	468
Bi-Flex Sleutels	159, 179
Bikhamers	770
Binnenmeetasters	324
Binnenmicrometers	319
Bitsen	107, 202, 204, 205, 206, 207
Bitsensets	107, 202, 203
Bitshouders	204, 205, 206
Bitsratels	128
Bitsschroevendraaiers	198
Blaaspistolen	603, 604, 605
Bladen voor cirkelzaagmachines	690, 1152
Blikscharen	116, 256, 257
Blindklinkbouten	235
Blindklinknagels	235
Blindklijktangen	232, 233, 234
Blokkalibers	337, 338
Bolkophamers	244
Booglasapparaten	752, 753, 754, 781, 782, 783
Boorbussen	1096
Boorfreesmachines	1000, 1004, 1006, 1008, 1010, 1012, 1014, 1016, 1018, 1020
Boorhouders	941, 1086, 1087, 1088, 1089
Boorkalibers	337
Boorklemmen	1100, 1101, 1102, 1103, 1104, 1105, 1106, 1107

Boorkoppen	941, 1086, 1087, 1088, 1089, 1090
Boormachines	936, 937, 938, 939, 940, 941, 944, 945, 946, 947, 948, 949, 950, 951, 952, 954, 956, 958, 960, 962, 964, 966, 968, 970, 971, 972, 974, 976, 978, 980, 982, 984, 986, 988, 990, 992, 994, 996
Boorslijpmachines	872, 873
Boosters	744, 745, 746
Boren	1138, 1139, 1140, 1141, 1142, 1143, 1144, 1145, 1150, 1151
Boren met conische schacht	1142
Borenssets	1136, 1137, 1142, 1143, 1144, 1150, 1151
Borenslijpmachines	872, 873
Borstels	266
Bougjedoppen	117, 133
Boutenscharen	254
Bouwlampen	352, 353, 354, 355
Bouwdrogers	624
Bouwvochtigheidsmeters	308
Bouwwerktuigen	620, 621, 622, 623
Brandkasten	494
Brandwerende kasten	494
Braseerraad	769
Breekijzers	115, 248, 249
Breekmessen	116, 253, 254
Buigmachines	808, 809, 810, 811, 812, 813, 814, 815, 822, 823, 826, 828
Buigtoestellen	808, 809, 810, 811, 812, 813, 814, 815
Buitenmicrometers	317
Buizenplooiers	808, 809, 810, 811, 812, 813, 814, 815
Buizensnijders	117, 254, 255
Buizensnijdersets	117
Buizentangen	182, 183
Bureaokabelbruggen	469
Bureaokabelkanalen	469
C	
Centerboren	1138, 1139, 1140, 1141, 1142, 1143, 1144, 1145, 1150, 1151
Centerpunten	244, 1097
Centreeerboren	1154
Centreerpinnen	1089, 1144, 1146, 1149
Cijferstempels	344, 345
Cilindrische boren	1136, 1137, 1138, 1139, 1140, 1141, 1142
Circlipstangen	111, 224
Cirkelsnijders voor plasma	775
Cirkelzaagbladen	1152, 1155, 1156, 1157, 1158, 1162

ALFABETISCHE INDEX

Cirkelzaagbladen voor afkort-zaagmachines	1152, 1153
Cirkelzaagbladen voor metaalzaagmachines	1152, 1153
Cirkelzaagmachines	878, 879, 880, 881, 882, 883, 884, 885, 887
CNC draaibanken	1072, 1073, 1074, 1075
CNC freesmachines	1066, 1068, 1070
Combinatietangen	110, 120, 219, 220, 223
Compressor olie	1132, 1133
Compressoren	633, 634, 635, 637, 638, 640, 641, 643, 647, 648, 650, 651, 653, 657, 664, 665
Compressoren met geïntegreerde motor	633, 634, 635, 638, 640, 643, 646, 648, 650, 651, 653, 657
Compressoren met riemaandrijving	638, 642, 643, 646, 647, 648, 649, 650, 652
Conische boren	1142, 1143
Conische trapboren	1138, 1139, 1140, 1141, 1142, 1143, 1144, 1145, 1150, 1151
Converters	748
Cuttermesses	116, 253, 254
D	
Dammers	628, 629
Damplaten	628, 629
Decibelmeters	306
Dieptemeters	316, 317
Diffusors voor plasmatoortsen	775
Digitaal meetgereedschap	307
Digitale batterijtesters	747
Digitale binnenmeetasters	324
Digitale dieptemeters	316
Digitale hoogtemeters	332
Digitale meetklokken	323
Digitale meetsystemen	933
Digitale multimeters	292, 293, 294
Digitale schuifmaten	312, 314, 315
Digitale thermometers	307, 308
Digitale uitlezing	1077
Digitale waterpassen	332, 335
Diktemeters	321, 322
Dinse stekkers	770
Direct aangedreven compressoren	633, 634, 635, 637, 638, 640
Direct spannende spantangen	1090
Doorduwdoppen	180
Doorslagen	243, 244
Dop- en dopbits schroevendraaiers	132
Dopbitsen	103, 134, 136, 138, 139, 144, 146, 164
Dopbitshouders	101, 102

Doppen	112, 113, 114, 117, 128, 129, 130, 131, 132, 133, 134, 135, 136, 137, 138, 139, 140, 142, 143, 144, 145, 146, 147
Doppen 1	140
Doppen 1/2	137, 138, 139
Doppen 1/4	133, 134
Doppen 3/4	139
Doppen 3/8	135, 136
Doppen op rail	163, 164, 165
Doppen op rail 1/2	156, 157, 158, 159, 160
Doppen op rail 1/4	163
Doppen op rail 3/8	163, 164
Doppen op rek	163, 164, 165, 281
Doppen op stag	163, 164, 165, 281
Doppensets	150, 151, 152, 153, 154, 155, 156, 157, 158, 159, 160, 161, 162, 163, 164, 165, 202, 281
Doppensets 1	161
Doppensets 1/2	156, 157, 158, 159, 160
Doppensets 1/4	133, 134, 150, 151, 152
Doppensets 3/4	160, 161
Doppensets 3/8	152, 153, 154, 155
Doppensets RVS	162
Dopschroevendraaiers	109, 189
Draadsnijkkussens	115, 264, 1110, 1111, 1112, 1113, 1114, 1115, 1116
Draadsnijmeters	343
Draadsnijwisselplaten	1126, 1131
Draadtappen	1113
Draadvergrendeltangen	262
Draagbare lasapparaten	753, 763, 781, 782, 783, 784, 785, 786, 788, 790, 791, 792
Draagbare lasinverters	752, 781, 782, 783
Draagbare starters	744, 745, 746
Draaibanken	1026, 1028, 1030, 1032, 1034, 1036, 1054, 1056, 1058, 1060, 1062
Draaibeitels	1122, 1123, 1124, 1125, 1126
Draaibeitelsets	1122, 1123, 1124, 1125, 1126
Draaimomentsleutels	112, 210, 212, 213, 214
Drempels	458, 459, 470, 471, 472, 473
Druppelladers	739, 740
Duimstokken	339
Duwmatrizen	802
E	
Elektrische lieren	398, 399, 400, 401, 402
Elektrische takels	398, 399, 400, 401, 402, 406, 407

Elektrische ventilatoren	724, 725, 726, 727, 730, 731	Geïsoleerde schroevendraaiers	109, 201, 202
Elektrische verwarming	714, 715, 717	Geïsoleerde tangen	223
Elektrode lasapparaten	752, 753, 754, 781, 782, 783	Geleidingsolie	1132, 1133
Elektrode lasinverteers	754	Geluidsmeters	306
Elektroden	766, 767, 769, 770	Generatoren	708, 711
Elektroden voor plasmatoortsen	774, 775	Gereedschap in EVA foam	118, 119, 120, 121, 122, 123
Elektronische schuifmaten	312, 314, 315	Gereedschap in muurrekken	124, 125
Engelse sleutels	106, 177, 178	Gereedschap in PS trays	98, 99, 100, 101, 102, 103, 104, 105, 106, 107, 108, 109, 110, 111, 112, 113, 114, 115, 116, 117, 200
ER25 losse spantangen	1090, 1092, 1093	Gereedschap in trays	98, 99, 100, 101, 102, 103, 104, 105, 106, 107, 108, 109, 110, 111, 112, 113, 114, 115, 116, 117, 118, 119, 120, 121, 122, 123, 124, 125, 200
ER32 losse spantangen	1090, 1091, 1092, 1093	Gereedschapshouders	558
ER40 losse spantangen	1090, 1091, 1092, 1093	Gereedschapskarren	73, 75, 77, 79, 82, 85, 87, 93, 95, 273, 274, 275, 282, 284, 286, 580
F		Gereedschapskasten	486, 487, 488, 490, 491, 493, 503, 504, 505, 506, 509, 510, 514, 515, 516, 517, 518, 519, 524, 528, 530, 531, 532, 534, 535, 536, 539, 542, 544, 546, 548, 551, 552, 554, 555, 556, 560, 561, 562, 563, 564, 565, 573, 586
Fijnstofmaskers	357, 358	Gereedschapskisten	64, 71, 95, 276, 277, 278, 280
Filterdrukregelaars	664, 665	Gereedschapskoffers	52, 53, 54, 55, 56, 57, 58, 59, 68, 69, 270, 271, 273, 274, 275, 277
Filters	704	Gereedschapsladen	98, 99, 100, 101, 102, 103, 104, 105, 106, 107, 108, 109, 110, 111, 112, 113, 114, 115, 116, 117, 200
Filtersleutels	263	Gereedschapssets	64, 65, 66, 67, 68, 71, 73, 75, 77, 82, 85, 87, 95, 150, 151, 152, 153, 154, 155, 156, 157, 158, 159, 160, 161, 162, 163, 164, 165, 276, 278, 280, 281
Filterzakken voor industriële stofzuigers	703	Gereedschapstassen	52
Filterzakken voor schuurmachines	869	Gereedschapstrolleys	56, 57, 58, 59, 60, 73, 75, 77, 79, 82, 85, 87, 93, 95, 270, 271, 273, 274, 275, 282, 284, 286, 288, 580
Flensen	1105	Gereedschapswagens	52, 53, 54, 55, 56, 57, 58, 59, 270, 271, 273, 274, 275, 580
Flenshoekhaken	327	Geslepen boren	264, 1136, 1137, 1143, 1144, 1150, 1151
Fleskriks	432, 435	Getrapte boren	1144, 1145
Flex hendels	130	Gevulde lasdraad	766, 767, 768, 769, 770
Flex ringsleutels	106, 179	Gewalste boren	264, 1136, 1137, 1143, 1144, 1150, 1151
Flex sleutels	130	Gezichtafscherming	450
Flux lasdraad	766, 767, 768, 769, 770	Gezichtbescherming	450
Flux-MIG-MAG lastoestellen	758, 759		
Freesbanken	1010, 1012, 1014, 1016, 1018, 1020		
Freeshouders	1090, 1091, 1092, 1093, 1094		
Freesklemmen	1101, 1102, 1103		
Freesmachines	699, 1010, 1014, 1016, 1018, 1020		
Frequentiemeters	292, 296, 297		
Frezen	1120, 1121		
Frezen met CNC besturing	1066		
Frezensets	1120		
G			
Garagekranen	434, 435		
Garagekriks	428, 429, 430		
Garageligbedden	413		
Garagepersen	794, 795, 796, 797, 798, 799, 800, 801, 802		
Garagestands	419		
Garagestoelen	413		
Gasregelaars	760, 761		
Gatzagen	1153, 1154		
Geconcentreerde snijolie	1134		
Geharde rollen	827, 831		

ALFABETISCHE INDEX

Gradenbogen	331, 332
Grafietbanden	863, 869, 1166, 1167, 1168, 1169, 1170, 1171, 1172
Graveermachines	344
Griptangen	111, 225, 226, 255

H

Haakpinsleutels	106, 181
Haaksebitshouders	207
Halogeen werkklampen	1108, 1109
Hamerlasbouten	772
Hamers	114, 244, 245, 246, 247
Handboormachines	607, 610, 614
Handborstels	266
Handgereedschap	64, 65, 66, 67, 68, 69, 71, 73, 75, 77, 82, 85, 87, 95, 276, 277, 278, 280
Handlampen	352, 353, 354, 355
Handmultimeters	292, 293, 294, 296, 297, 310
Handschoenen zandstraal-cabines	452
Handtakels	403, 404, 405
Handtappen	115, 264, 1110, 1111, 1112, 1113, 1114, 1115, 1116
Handzagen	252
Hanglampen	354
Hardheidsmeters	307
Hardsoldeerdraad	768, 769, 770
Hartzoekers	326
Hefbruggen	370, 371, 372
Hefmagneten	407
Hef tafels	370, 371, 372
Herriemeters	306
Hijsmateriaal	398, 399, 400, 401, 402, 403, 404, 405, 406, 407
Hittebestendige dekens	771
Hoekuitkapmachines	839
Holpijpen	247
Hoofdbescherming	356, 357, 358, 450
Hoofdlampen	354
Hoogtemeters	332
Houtbewerkingsmachines	683
Houtboren	264, 1136, 1137, 1143, 1144, 1150, 1151
Houtborensset	264, 1136, 1137, 1143, 1144, 1150, 1151
Houtsplitters	700
Hydraulische fleskriks	432, 435
Hydraulische hefbruggen	370, 371, 372
Hydraulische hoekuitkapmachines	839
Hydraulische olie	1132, 1133
Hydraulische persen	794, 795, 796, 797, 798, 799, 800, 801

Hydraulische rolkriks	428, 429, 430
Hydraulische uitdeuksets	432
Hydropneumatische rolkriks	430
Hygiënemaskers	357, 358

I

Inbusleutels	183, 184, 185, 187
Industriële matten	458, 459
Infrarood verwarming	714, 715, 717, 718, 719
Inox lasdraad	766, 767, 768, 769, 770
Inslagletters	344, 345
Inspectiecamera's	298, 299
Inspectiemateriaal	298, 299, 300
Intelligente elektronische batterijladers	736, 737, 738, 741
Inverter lasapparaten	752, 753, 754, 781, 782, 783
Inwendige draaibeitels	1122, 1123, 1124, 1125, 1126

J

Jerrycans	412
-----------	-----

K

Kabelbescherming	469, 470
Kabelbeveiliging	469, 470
Kabelbruggen	469, 470
Kabelhaspels	414, 415, 416, 417, 418
Kabelknippers	219, 256
Kabelkrimptangen	231
Kabellieren	398, 399, 400, 401, 402
Kabelscharen	256
Kabelschoentangen	114, 228, 229, 230, 231
Kabeltakels	403, 405
Kalibers voor boren	337
Kalibers voor lassen	337
Kasten	489, 490, 491, 492, 493, 494, 502, 503, 504, 505, 506, 508, 510, 512, 514, 515, 516, 517, 518, 520, 524, 528, 531, 532, 534, 535, 536, 538, 539, 542, 544, 546, 548, 551, 552, 554, 555, 556
Kegeldoorns	1087, 1088, 1117
Keramische koppen	452
Kernboorhouders	941, 1086, 1087, 1089, 1090, 1146
Kernboren	1089, 1144, 1146, 1149
Kernborenssets	1146, 1147
Kettingtakels	403, 404, 405
Klauwhamers	245
Klauwplaten	1093, 1097
Kleerkasten	493, 520
Klemgereedschap	1086
Klemmen	668, 669, 674, 676, 677, 679, 681, 685, 687, 693, 700, 701, 702, 703, 704, 706, 1168, 1170

Klemmensets	1101, 1102, 1103, 1104, 1105, 1106, 1107
Klemtangen	114, 262, 263, 265
Klokszagen	1153, 1154
Knabbelscharen	609
Knijptangen	218, 219, 220, 221, 223
Knipscharen	803, 804
Knijptangen	218, 219, 220, 221, 223
Koelolie	1133, 1134
Koevoeten	115, 248, 249
Kolomboormachines	960, 962, 964, 966, 968, 970, 971, 972, 974, 976, 978, 980, 982, 984, 986, 988, 990, 992, 994
Kolomvijzels	405
Koolborstels	668, 669, 674, 676, 677, 679, 681, 685, 687, 693, 700, 701, 702, 703, 704, 706, 1168, 1170
Koper lasdraad	766, 767, 768, 769, 770
Kopieerfreezen	1121
Kopiëerinrichting voor houtdraaibanen	668, 669, 674, 676, 677, 679, 681, 685, 687, 693, 700, 701, 702, 703, 704, 706, 1168, 1170
Kopknijptangen	219
Koppelvermeerderaars	132
Koptelefoons	358
Kottergereedschap	1117
Kotterkoppen	1117
Krasblokken	333
Kraspennen	330
Kriks	428, 429, 430
Krimptangen	231
Krompassers	329
Kruiskopschroevendraaiers	198
Kruistafels	1101, 1102, 1103, 1104, 1105, 1106, 1107
Kussenhouders	1115
Kwaliteitschuurschijven	863, 869, 1166, 1169, 1171, 1172
Kwaliteitsschuurbanden	869, 1166, 1167, 1168, 1169, 1170, 1171
L	
Laadvlakken	366
Ladekasten	486, 487, 488, 489, 490, 491
Ladeverdeling	268, 269, 491, 495
Lagerpersen	806
Lagersolie	1132, 1133
Lampen	352, 353, 354, 355
Lamptesters	298
Lange bitsen	205, 206
Lasafscherming	771
Lasapparaten	752, 753, 756
Lasbekken	759, 760, 761

Lasbescherming	356, 357, 771
Lasbouten	772
Lasbranders	772
Lasbrillen	357
Lasdraad	766, 767, 768, 769, 770
Laselektroden	766, 767, 769, 770
Laser afstandmeters	301
Lashelmen	356, 357
Lasinverters	752, 753, 754, 781, 782, 783
Laskalibers	337
Laskappen	356, 357
Lasmagneten	60, 116, 267, 268, 269
Laspistolen	772
Lasrivetten voor spotters	778
Lasschermen	771
Lasschorten	771
Lastangen voor elektroden	770
Lastips	759, 760, 761
Lastoestellen	752, 753, 754, 755, 756, 757, 758, 759, 760, 761, 762, 763, 764, 765, 766, 767, 768, 769, 770, 771, 772, 773, 774, 775, 776, 777, 778, 782, 783, 784, 786
Lasvet	772
Lasvloeistof	772
LED werklampen	352, 353, 354, 355
Lekbakken	420, 421, 474, 475, 476, 477, 478, 479
Lieren	398, 399, 400, 401, 402
Ligbedden	413
Ligkarren	413
Lijmklemmen	227
Lijmtangen	227
Lintzaagbladen	1155, 1156, 1157, 1158, 1162
Lintzaagmachines	890, 891, 892, 893, 894, 895, 896, 898, 904, 910, 912, 914, 924
Lockers	493
Looplampen	352, 353, 354, 355
Luchtcompressoren	633, 635, 636, 637, 638, 640, 642, 643, 646, 647, 648, 649, 650, 651, 652, 653, 654, 655, 657
Luchtdruk beitelhamers	613
Luchtdruk blaaspistolen	603, 604, 607, 618, 619
Luchtdruk boormachines	607, 614
Luchtdruk gereedschapsaan-trekkers	1118
Luchtdruk knabbelscharen	609
Luchtdruk olie	1132, 1133
Luchtdruk persen	794, 795, 796, 797, 798, 799, 800, 801
Luchtdruk taparmen	998

ALFABETISCHE INDEX

Luchtdruk verfpistolen	617, 618, 619	Metaalboormachines	936, 937, 938, 939, 940, 941, 944, 945, 946, 947, 948, 949, 950, 951, 952, 954, 956, 958, 960, 962, 964, 966, 968, 970, 971, 972, 974, 976, 978, 980, 982, 984, 986, 988, 990, 992, 994, 996
Luchtdrukgereedschap	602, 603, 604, 605, 606, 607, 608, 609, 610, 611, 612, 613, 614, 617, 618, 619	Metaalboren	1136, 1137, 1138, 1139, 1140, 1141, 1142, 1143, 1144, 1145, 1146, 1147, 1148, 1149, 1150, 1151
Luchtdrukslangen	602	Metaalborensets	1136, 1137, 1142, 1143, 1144, 1145, 1146, 1147
Luchthaspels	414, 415, 416	Metaalfreesmachines	1010, 1012, 1014, 1016, 1018, 1020
M		Metaallintzaagmachines	888, 889, 890, 891, 892, 893, 894, 895, 896, 898, 900, 902, 904, 906, 908, 910, 912, 914, 916, 918, 920, 924, 926, 928, 930
Maatlatten	337	Metaalscharen	806, 807, 839
Machineklemmen	1100, 1101, 1102	Metaalzagen	878, 879, 880, 881, 882, 883, 884, 885, 886, 887, 888, 889, 890, 891, 892, 893, 894, 895, 896, 898, 900, 902, 904, 906, 908, 910, 912, 914, 916, 918, 920, 924, 926, 928, 930
Machinelampen	1108, 1109	Metalen koffers	52, 271, 272, 497, 498, 499
Machinelolie	1132, 1133	Micrometers	317, 318, 319, 320
Machinetappen	264, 1099, 1110, 1116	MIG toortsen	759, 760, 761
Machineverlichting	1108, 1109	MIG-MAG lasapparaten	755, 756, 757
Machinevoeten	862, 887, 1001, 1003, 1007	Milieukasten	494
Magazijnbakjes	268, 269, 272, 491, 492, 493, 495	MMA lasapparaten	781
Magazijnwagens	366	Mobiele ventilatoren	724, 725, 726, 727, 730, 731
Magneetboormachines	936, 937, 938, 939, 940, 941	Moeniertangen	219
Magneten	60, 116, 267, 268, 269	Momentsleutels	112, 200, 210, 212, 213, 214
Magnetische bitshouders	204	Montageligbedden	413
Magnetische opspanplaten	1101, 1102, 1103, 1104, 1105, 1106, 1107	Montagesleutels	181
Magnetische rails	268, 269	Morse Konus boren	1142, 1143
Mallen	343	Morse Konus borenssets	1142
Manometers	664, 665	Motorhangers	433
Manuele persen	794, 795, 796, 797, 798, 799, 800, 801, 802, 806	Motorische persen	795, 796, 797, 798, 799, 800, 801
Manuele tafelpersen	794	Motorliften	370, 371, 372
Markeerkrijt	345	Motorstands	413
Markeerstiften	345	Motorsteunen	413
Materiaalreinigers	444, 445, 446, 447, 448, 449	Motortakels	403, 404, 405
Materiaalschragen	706, 932	Multimeters	292, 293, 294, 295, 297
Materiaalstanden	706, 932	Multistanden	706, 932
Materiaalsteunen	706, 932	Musketons	408, 409
Mechanische freesklemmen	1101, 1102, 1103, 1104, 1105, 1106, 1107		
Mechanische takels	403, 404, 405		
Meedraaiende centerpunten	1097		
Meelopende brillen	1119		
Meetapparatuur	307		
Meetinstrumenten	307		
Meetklokken	322, 323, 324, 325		
Meetlint	301, 338, 339, 340, 341		
Meetsets	117		
Meetstandaards	333, 334		
Meetstukken	334		
Meetwielen	301		
Metaalafkortzagen	878, 879, 880, 881, 882, 883, 884, 885, 886, 887		
Metaalbandschuurmachines	864, 865, 866, 867, 868, 870		
Metaalbeitels	242		

Muurkasten	489, 490, 491, 492, 493, 494, 503, 504, 506, 508, 509, 514, 516, 517, 518, 519, 520, 524, 528, 531, 532, 534, 535, 536, 538, 539, 540, 542, 544, 547, 548, 550, 551, 552, 554, 555, 556
------------	-----------------------------------------------------------------------------------------------------------------------------------------------------------------------------------------

N

Nageltangen	225, 226
-------------	----------

O

Ohmmeters	292, 293, 294, 296, 297, 310
-----------	------------------------------

Olie	1132, 1133, 1134
------	------------------

Olieopvang	420, 421, 423
------------	---------------

Olievervelaars	664
----------------	-----

Omgevingsspiegels	468
-------------------	-----

Onderdelenreinigers	437, 438, 439
---------------------	---------------

Ondersteuningsbokken	706, 932
----------------------	----------

Ontvetter	437, 438, 439
-----------	---------------

Oorbescherming	358
----------------	-----

Oorkappen	358
-----------	-----

Opbergbakjes	268, 269, 272, 491, 493, 495
--------------	------------------------------

Opbergkasten	486, 487, 488, 489, 492, 502, 503, 504, 505, 506, 508, 509, 510, 512, 514, 515, 516, 517, 518, 519, 520, 524, 574
--------------	-------------------------------------------------------------------------------------------------------------------

Opbergkoffers	52, 53, 54, 55, 59, 270, 271, 272, 497, 498, 499
---------------	--------------------------------------------------

Opbergssystemen	52, 53, 54, 55, 56, 57, 58, 59, 60, 270, 271, 272, 273, 274, 275, 497, 498, 499, 580
-----------------	--------------------------------------------------------------------------------------

Opbergtassen	52
--------------	----

Opgebraseerde beitels	1122
-----------------------	------

Opnamehouders vlakfrezen	1093, 1094
--------------------------	------------

Oprijdrempels	471, 472, 473
---------------	---------------

Oprijhelling	377, 378, 379, 380, 381, 382, 383, 384, 386, 387, 388, 389, 390, 391, 392, 393, 395
--------------	-------------------------------------------------------------------------------------

Oprijplaten	377, 378, 379, 380, 381, 382, 383, 384, 386, 387, 388, 389, 390, 391, 392, 393, 395
-------------	-------------------------------------------------------------------------------------

Oprolhaspels	414, 415, 416, 417, 418
--------------	-------------------------

Opspangereedschap	1095
-------------------	------

Opspangereedschap draai-bank	1093, 1095, 1096, 1097, 1119
------------------------------	------------------------------

Opsteekleutels	180
----------------	-----

Opvangbakken	474, 475, 476, 477, 478, 479
--------------	------------------------------

Opvangpalletten	474, 475, 476, 477, 478, 479
-----------------	------------------------------

Orion-koppelingen	603, 604, 605, 607, 608
-------------------	-------------------------

P

Palletwagens	366, 367, 368, 369
--------------	--------------------

Papierrolhouders	412
------------------	-----

Papierrollen	412
--------------	-----

Parallele onderlegblokken	1101, 1102, 1103, 1104, 1105, 1106, 1107
---------------------------	------------------------------------------

Parkeerbeugels	467
----------------	-----

Passers	328, 329
---------	----------

Pasta voor vloeioren	1133, 1134
----------------------	------------

Pendrijvers	125, 243, 244
-------------	---------------

Permanente hefmagneten	407
------------------------	-----

Perslucht beitelhamers	613
------------------------	-----

Perslucht blaaspistolen	603, 604, 605
-------------------------	---------------

Perslucht gereedschap	603, 604, 605, 607, 608, 610
-----------------------	------------------------------

Perslucht handboormachines	607
----------------------------	-----

Perslucht knabbelscharen	609
--------------------------	-----

Perslucht slagmoersleutels	610, 611, 612
----------------------------	---------------

Perslucht taparmen	998
--------------------	-----

Perslucht verfpistolen	617, 618, 619
------------------------	---------------

Perslucht-blaaspistool	603, 604, 607, 619
------------------------	--------------------

PH bitsen	204, 205, 206
-----------	---------------

PH schroevendraaiers	108, 109, 122, 192, 193, 195, 196, 197, 198, 199
----------------------	--------------------------------------------------

Pick-up tools	267
---------------	-----

Pijpentangen	183
--------------	-----

Pijpsnijders	117, 254, 255
--------------	---------------

Pincetten	257, 772
-----------	----------

Pistolen	603, 604, 605, 607, 608
----------	-------------------------

Plaatrolmachines	831, 832, 833, 834, 835, 836, 837, 838
------------------	----------------------------------------

Plaatscharen	116, 256, 257, 804
--------------	--------------------

Plaatslagershamers	246, 247
--------------------	----------

Plasma lastoortsen	774
--------------------	-----

Plasmabranders	773, 792
----------------	----------

Plasmasnijders	773, 792
----------------	----------

Platbektangen	219, 220, 221
---------------	---------------

Platformwagens	366
----------------	-----

Platte beitels	242, 613
----------------	----------

Platte schroevendraaiers	125, 201, 202
--------------------------	---------------

Plooiomachines	808, 809, 810, 811, 812, 813, 814, 815
----------------	----------------------------------------

Pneumatisch gereedschap	603, 604, 605, 607, 608
-------------------------	-------------------------

Pneumatisch verfpistool	617, 618, 619
-------------------------	---------------

Pneumatische beitelhamers	613
---------------------------	-----

Pneumatische blaaspistolen	603, 604, 605
----------------------------	---------------

Pneumatische cartouchepistolen	607
--------------------------------	-----

Pneumatische gereedschaps-aantrekkers	1118
---------------------------------------	------

Pneumatische handboormachines	607, 614
-------------------------------	----------

Pneumatische hefbruggen	370, 371, 372
-------------------------	---------------

Pneumatische knabbelscharen	609
-----------------------------	-----

Pneumatische knipscharen	803, 804
--------------------------	----------

Pneumatische olie	1132, 1133
-------------------	------------

Pneumatische schuurmachines	615
-----------------------------	-----

ALFABETISCHE INDEX

Pneumatische siliconespuiters	607	Ringsleutels	106, 174, 175, 176, 178
Pneumatische slagmoersleutels	610, 611, 612	Riveteertangen	232, 233, 234, 235
Pneumatische slijpers	608, 609	Roestvrije borstels	266
Pneumatische taparmen	998	Rolbokken	706
Pneumatische verfpistolen	617, 618, 619	Rolkriks	428, 429, 430, 432
Poelietrekkers	115, 236, 237, 238, 239	Rollenbanen	705, 706, 934, 935
Poliermachines	614, 615, 861	Rolmachines	831, 832, 833, 834, 835, 837, 838
Polierschijven	863, 869, 1166, 1169, 1171, 1172	Rolmeters	341
Polierwas	1134	Rondbektangen	219, 220, 221, 224
Pompwagens	366, 367, 368, 369	Rondborstels	863, 869, 1166, 1169, 1171, 1172
Ponsen	839	Roteerfrezen	1120
Popnageltangen	232, 233, 234	Rutiel laselektrodes	766, 767, 769, 770
Poulietrekkers	115, 236, 237, 238, 239	S	
Priemen	114, 249	Sableercabines	447, 448, 449
Productiezaagmachines	878, 880, 881, 882, 883, 884, 887, 888, 889, 891, 892, 893, 894, 895, 896, 898, 900, 902, 904, 906, 908, 910, 912, 914, 916, 918, 920, 922, 924	Schaafmessen	802, 808, 809, 810, 823, 825, 827, 831, 839, 869
Profielbuigmachines	822, 823, 826, 828, 829	Schaarhekken	460, 461, 462, 463
Profielmallen	343	Scharen	257
Profielsharen	806, 807, 839	Schijfschuurmachines	669, 864
Profielwalsmachines	822, 823, 826, 828	Schoenen	360, 361, 362, 363
Publiciteitsmateriaal	259	Schokdempers	467
Puntlasapparaten	776, 777	Schragen	706, 932
Puntlasboren	1151	Schrapers	249
Puntlasfrezen	1151	Schrobzagen	252
Punttangen	218, 219, 220, 221	Schroefbanken	1100, 1101, 1102, 1103
PVC geleidingsrollen	668, 669, 674, 676, 677, 679, 681, 685, 687, 693, 700, 701, 702, 703, 704, 706, 1168, 1170	Schroefdraad snijsets	115, 264, 1110, 1111, 1112, 1113, 1114, 1115, 1116
PZ bitsen	205	Schroefdraadboren	1113
PZ schroevendraaiers	193, 196	Schroefdraadherstelsets	264, 1116
R		Schroefdraadmallen	343
Raamwaterpassen	334	Schroefdraaduitdraaiers	115, 264, 1110, 1111, 1112, 1113, 1114, 1115, 1116
Radiaalboormachines	996	Schroefsleutels	182
Radiusmallen	343	Schroevendraaiers	108, 109, 125, 192, 193, 195, 196, 197, 198, 199, 201, 202, 203
Rails en siorbanden voor rails	408, 409	Schuifmaten	310, 311, 312, 313, 314, 315
Ratel verlengstukken	131	Schuifpassers	310, 311, 312, 313, 314, 315
Ratels	128, 129	Schuurbanden	869, 1166, 1167, 1168, 1169, 1170, 1171
Ratelsleutels	174, 176, 177	Schuurmachines	614
Ratel-steekringsleutels	104, 105, 106, 168, 169, 170, 171, 172, 173	Schuurmiddel	1166
Rateltakels	403, 404, 405	Schuurpapier	869, 1166, 1167, 1168, 1169, 1170, 1171
Reductiehuizen	1088	Schuurschijven	863, 869, 871, 872, 1172
Reinigingstoestellen	436	Seegerringtangen	224
Retentiebakken	420, 421, 474, 475, 476, 477, 478, 479	Signalisatielint	460, 461, 462, 463
Riemaangedreven compressoren	638, 643, 647, 648, 650	Siliconespuiten	607
Riemaangedreven kolomboormachines	944, 945, 946, 947, 948, 949, 950, 951, 954, 960, 962, 964, 966, 968, 970, 996	Siorbanden	409, 410
		Slagcijfers	344, 345

Slagdommen	112, 113, 114, 140, 142, 143, 144, 145, 146, 147
Slaggereedschap	242
Slagletters	344, 345
Slagringsleutels	176, 178
Slagscharen	803, 804
Slagschroevendraaiers	142
Slangbindingen	347, 348, 349, 350, 351
Slanghaspels	414, 415, 416, 418
Slangklemmen	203, 346, 347, 348, 349, 350, 351
Sleufkopschroevendraaiers	108, 109, 122, 192, 193, 195, 196, 197, 198, 199
Seutels	166
Slijpmachines	668, 862, 863, 864, 866, 867, 868, 869, 870, 872, 873
Slijpstenen	863
Smeergereedschap	423, 424, 425, 426
Smeermiddel	1132, 1133, 1134, 1135
Sneldraaistaal	1121
Snelkoppelingen	603, 604, 605, 607, 608
Snelstarters	744, 745, 746
Snijblokken	1114, 1115
Snijgereedschap	252, 253, 254, 255, 256, 257
Snij-ijsers	115, 264, 1110, 1111, 1112, 1113, 1114, 1115, 1116
Snijkussens	115, 264, 1110, 1111, 1112, 1113, 1114, 1115, 1116
Snijmoeren	115, 264, 1110, 1111, 1112, 1113, 1114, 1115, 1116
Snijolie	1132, 1133, 1134
Snijplaten	1126, 1127, 1128, 1129, 1130, 1131
Snijspray voor metaal	1134
Snijtoestellen	772
Snijwas	1133, 1134
Snoerhaspels	416, 417, 418
Soevereinboren	1144
Soldeergereedschap	772
Spaanoprapers	1085
Spanbanden	409, 410
Spanningsmeters	292, 293, 294, 296, 297, 310
Spanningstesters	292, 293, 294, 295, 297
Spantangen	1090, 1091, 1092, 1093, 1097
Spantangenhouders	1090, 1091
Spanvijzen	227
Speedboren	1151
Spiebaanfrezen	1121
Spijkertangen	219

Spiraalboren	1136, 1139, 1140, 1141, 1142, 1143, 1146, 1147, 1148
Spiraalslangen	602
Spuitbushouders	60, 275
Staafelektroden	754, 766
Staaldraad borstels	266
Staalplaatscharen	806, 807, 839
Stampers	628, 629
Stapbescherming	469, 470
Starters	744, 745, 746
Starters-Boosters	744, 745, 746
Startkabels	749
Stationaire compressoren	641, 651, 653, 657
Steekringsleutels	104, 105, 106, 168, 169, 170, 171, 172, 173
Steeksleutels	106, 177, 178
Steekwagens	364, 365, 374
Steenboren	264, 1136, 1137, 1143, 1144, 1150, 1151
Stempelsets	344, 345
Steunblokken	336
Stiftsleutels	107, 187, 188, 189
Stofzuigers- en spaanderzuigers	702, 703
Straalpistoel	450, 452
Straalzaad	447, 448, 449, 450, 451, 452
Stroommeters	292, 293, 294, 296, 297, 310
Stroomomvormers	748
Struikelbescherming	469, 470
T	
Tachometers	306
Tafelboormachines	944, 945, 946, 947, 948, 949, 950, 951, 952, 954, 956, 958, 971
Tafelcirkelzaagmachines	878, 879, 880, 881, 882, 885, 887
Tafelpersen	794
Tafelplaatscharen	803, 804
Tafelscharen	803, 804
Tafelhouders	407
Takels	398, 399, 400, 401, 402, 403, 404, 405, 406, 407
Tandkrans boorhouders	941
Tandwielaaangedreven kolom-boormachines	958, 982, 984, 986, 988, 990, 992, 994
Tandwielolie	1132, 1133
Tangen	110, 111, 218, 219, 220, 221, 223, 224, 225, 226, 227, 255
Tapapparaten	1099
Taphouders	1099
Tapkoppen	1099
Tappen	1113

ALFABETISCHE INDEX

Tappen- en kussensets	115, 1110, 1111, 1112	Veiligheidsafscherming voor draaibanken	1082, 1083, 1084
Tappotten	1099	Veiligheidsafscherming voor freesmachines	1085
Tapsleutels	1115, 1116	Veiligheidsmarkering	460
Terugslagvrije hamers	247	Veiligheidsmaskers	357, 358
Testers	297	Veiligheidsschoenen	360, 361, 363
T-gleufbeschermers	1119	Veiligheidsspiegels	468, 469
T-grepen	130	Veiligheidsuitrusting	360, 361, 363
T-handvaten	117, 227	Ventilatoren	724, 725, 726, 728, 730, 731
T-hendels	130	Verbindingsringen afsluitketting	460, 461, 462, 463
Thermometers	292, 293, 294, 307, 308	Verdeelstekkers	418
TIG lasapparaten	762, 763, 764	Verfpistoolreinigers	440, 441, 442
TIG toortsen	765	Verfspuiten	617, 618, 619
Tindraad	772	Verfspuitmaskers	357, 358
Toegangsdrempels	470, 471, 472, 473	Verkeersdrempels	471, 472, 473
Toerentalmeters	306	Verkeerskegels	461
Torenfreemachines	1010, 1012, 1014	Verkeersspiegels	468
Torx sleutels	107, 187, 188, 189	Verlengkabels	414, 415, 416, 417, 418
Transfo elektrodelasapparaten	754	Verlengsnoeren	416, 417, 418
Transmissie olie	1132, 1133	Verlichtingsmateriaal	352, 353, 354, 355
Transmissiekriks	431	Vermogensmeters	292, 293, 294, 296, 297, 310
Transpalletwagens	366, 367, 368, 369	Vernevelapparaten	1135
Transportkarren	366	Vervangglazen lasbrillen	357
Transportmateriaal	364, 365, 366, 367, 368, 369, 372, 373, 374	Vervangmatrijzen	802, 808, 809, 810, 823, 825, 827, 831, 839, 869
Transportrollen	372, 373, 374, 375	Vervangmessen	668, 669, 674, 676, 677, 679, 681, 685, 687, 693, 700, 701, 702, 703, 704, 706, 802, 808, 809, 810, 823, 825, 827, 831, 839, 869, 1168, 1170
Transportwagens	366	Vervangstukken poelietrekkers	239
Trapboren	1144, 1145	Verwarmingstoestellen	714, 715, 717, 718, 719, 720, 721, 722, 723, 724, 725, 726, 728, 730, 731
Trechters voor opvangbakken	420, 421	Verzinkboren	264, 1136, 1137, 1138, 1139, 1140, 1141, 1142, 1143, 1144, 1145, 1150, 1151
Trekmagneten	407	Vibrometers	306
Trillingsdempers	1119	Vijlen	115, 117, 258
Trillingsmeters	306	Vingerfrezen	1121
Trilplaten	628, 629	Vlakfrezen	1093, 1094, 1121
Trilstampers	628, 629	Vlakplaten	337
TX Schroevendraaiers	198, 199	Vlaktafels	337
U		Vloeiboren	1149
Uitdeuksets	432	Voedingsmotors	1118
Uitdrijfspeien	1089	Voelermaten	341, 342
Uithoekscharen	839	Voetbescherming	360, 361, 363
Uitschuifmessen	116, 253, 254	Voetpassers	329
Ultrasoonreinigers	444, 445, 446	Voltmeters	292, 293, 294, 296, 297, 310
Umbracosleutels	107, 187, 188, 189	Vrachtgordels	409, 410
Universeelmeters	292, 293, 294, 296, 297, 310		
V			
Vakverdeling	98, 99, 100, 101, 102, 103, 104, 105, 106, 107, 108, 109, 110, 111, 112, 113, 114, 115, 116, 117, 200		
Vaste brillen	679, 1119		
Vatenkarren	479		
V-blokken	336		
Veiligheidsafscherming voor boormachines	1080, 1081		

W

Walstoestellen	831, 832, 833, 834, 835, 836, 837, 838
Wandkasten	486, 487, 488, 489
Wandpanelen	486, 487, 488, 489
Wandrekken voor gereedschap	124, 125, 174, 197, 243, 483, 488, 489
Warmeluchtblazers	717, 718, 719, 720, 721, 722, 723
Waterpassen	334
Waterpompen	626, 627
Weerstandsmeters	292, 293, 294, 296, 297, 310
Wegwerpmaskers	357, 358
Werkkoffers	497, 498, 499
Werkbanken	482, 483, 484, 485, 486, 487, 488, 495, 496, 582, 583, 584, 585, 586, 588, 590, 591, 592, 596, 597, 598, 599, 600, 706, 707
Werkbankpersen	794
Werkkisten	497, 498, 499
Werkkoffers	52, 270, 271, 272
Werklampen	1108, 1109
Werkplaatsbanken	482, 483, 484, 485, 486, 487, 488, 582, 583, 584, 588, 590, 596, 597, 598, 599, 600
Werkplaatsinrichting	486, 487, 488, 489, 490, 491
Werkplaatskasten	490, 491, 492, 493, 494, 504, 505, 506, 508, 510, 512, 514, 515, 516, 517, 518, 519, 520, 524, 530, 531, 532, 534, 535, 536, 539, 540, 542, 543, 544, 546, 548, 550, 551, 552, 554, 555, 556
Werkplaatskranen	434, 435
Werkplaatskrukjes	413
Werkplaatsladekasten	490, 491, 528, 531, 534, 535, 536, 538, 539, 540, 543, 544, 546, 547, 548, 550, 552, 554, 555, 556, 573
Werkplaatsmeubilair	268, 269, 272, 482, 483, 484, 485, 488, 489, 491, 492, 493, 494, 495, 497, 498, 499, 502, 503, 504, 505, 506, 508, 509, 510, 512, 514, 515, 516, 517, 518, 519, 520, 524, 528, 530, 531, 532, 534, 535, 536, 538, 539, 540, 542, 543, 544, 546, 547, 548, 550, 551, 552, 554, 555, 556, 557, 558, 559, 560, 561, 562, 563, 564, 565, 566, 567, 568, 570, 572, 573, 574, 576, 578, 579, 580, 581, 582, 583, 584, 585, 586, 588, 590, 591, 592, 596, 597, 598, 599, 600

Werkplaatspersen	794, 795, 796, 797, 798, 799, 800, 801, 802
Werkplaatsstoelen	413
Werkplaatstafels	482, 483, 484, 485, 486, 487, 488, 524, 582, 583, 584, 588, 590, 596, 597, 598, 599, 600
Werkplaatsuitrusting	497, 498, 499
Werkplaatswagens	273, 274, 275, 580
Werk schoenen	360, 361, 363
Werkstukaandrukkers	1100, 1101, 1102, 1103, 1104, 1105, 1106, 1107
Werkstukaanslagen	1100, 1101, 1102, 1103, 1104, 1105, 1106, 1107
Werkstukklemming tafel	1100, 1101, 1102, 1103, 1104, 1105, 1106, 1107
Werkstukstoppers	668, 669, 674, 676, 677, 679, 681, 685, 687, 693, 700, 701, 702, 703, 704, 706, 1168, 1170
Werktafels	482, 483, 484, 485, 486, 487, 488, 582, 583, 584, 588, 590, 596, 597, 598, 599, 600
Wielsleutels	130
Winkelhaken	325, 326, 327
Wisselplaten	1126, 1127, 1128, 1129, 1130, 1131
Wisselplaten voor vlakfrezen	1121
Wringijzers	1115

Z

Zaagbladen	668, 669, 674, 676, 677, 679, 681, 685, 687, 693, 700, 701, 702, 703, 704, 706, 1152, 1153, 1155, 1156, 1157, 1158, 1162, 1168, 1170
Zaagbokken	706, 932
Zaagmachines	684, 685, 686, 688, 689, 690, 691, 693, 694, 695, 696, 697, 701
Zaklampen	352, 353, 354, 355
Zandstraalcabines	447, 448, 449, 450
Zandstraalketels	447
Zandstraalmachines	447, 448, 449
Zandstraalpistoelen	450, 452, 453
Zelfcenterende machineklemmen	1100, 1101, 1102, 1103, 1104, 1105, 1106, 1107
Zeskant schroevendraaiers	107, 124, 183, 184, 185, 187, 188

NUMERIEKE INDEX

Order nr.	Pag.	Order nr.	Pag.	Order nr.	Pag.	Order nr.	Pag.	Order nr.	Pag.
01101708	131	101670206	131	101800209	189	102080207	136	105930101	221
01101807	131	101690105	135	101800308	189	102080306	136	106040108	204
01101906	131	101690204	135	101800407	189	102080405	136	106040207	204
01102003	131	101690303	135	101800506	189	102080504	136	106040306	204
01102102	131	101690402	135	101800605	189	102080603	136	106040405	204
01102201	131	101690501	135	101800704	189	102080702	136	106040504	204
03050101	132	101700102	177	101800803	189	102080801	136	106040603	204
03120102	142	101700201	177	101800902	189	102080900	136	106040702	204
03120201	142	101700300	177	101801009	189	102090107	136	106041007	204
03130101	249	101700409	177	101850105	134	102090206	136	106041106	204
03450103	56	101700508	177	101850204	134	102090305	136	106041205	204
03450202	268	101700607	177	101850303	134	102090404	136	106041403	204
03490109	100	101700706	177	101850402	134	102090503	136	106041601	204
03520103	100	101700805	177	101850501	134	102090602	136	106050107	204
03570108	101	101700904	177	101860104	205	102090701	136	106050206	204
03570207	101	101701001	177	101860203	205	102090800	136	106050305	204
03570256	101	101701100	177	101860302	205	102090909	136	106050404	204
03570306	102	101710101	164	101860401	205	102100104	114	106050503	204
03691458	1086	101780021	145	101860500	205	102100104	142	106051006	204
03691755	1086	101780039	145	101860609	205	102100203	143	106051105	204
03890100	98	101780062	145	101860708	205	102110104	112	106051204	204
03900107	106	101780096	145	101860807	205	102110104	212	106051303	204
03900107	177	101780104	145	101860906	205	102120102	106	106060106	204
03960101	115	101780153	145	101861003	205	102120102	181	106060205	204
03960101	265	101780203	145	101870103	206	102140100	102	106060304	204
03980109	115	101780302	145	101870202	206	102150109	197	106060403	204
03980109	236	101780401	145	101870301	206	102151008	198	106060502	204
04030102	111	101780500	145	101870400	206	102151107	198	106060601	204
04030102	224	101780609	145	101870509	206	102151206	198	106070105	205
04160107	98	101780633	145	101870608	206	102151305	198	106070204	205
04160206	98	101780658	145	101870707	206	102151404	198	106070303	205
04200101	267	101780708	145	101870806	206	102151503	198	106070402	205
04850103	164	101780757	145	101870905	206	102180106	164	106070501	205
06790109	131	101780807	145	101871002	206	102300100	330	106080104	205
06790158	131	101780815	145	101880102	205	102300209	330	106080203	205
06790208	131	101780823	145	101880201	205	102360104	311	106080302	205
06790307	131	101780831	145	101880300	205	102369150	311	106081003	205
06790356	131	101780849	145	101880409	205	102380102	319	106081102	205
06790406	131	101780856	145	101880508	205	102610102	202	106081201	205
06790455	131	101780864	145	101880607	205	102630100	202	106090103	205
06790505	131	101780872	145	101880706	205	103900106	322	106090202	205
06790604	131	101780930	145	101880805	205	104450101	108	106090301	205
06790703	131	101780963	145	101880904	205	104450101	197	106090400	205
07490055	334	101780997	145	101881001	205	105810105	247	106090509	205
07490154	334	101781003	145	101890101	206	105810204	187	106100100	204
07490204	334	101781052	145	101890200	206	105820104	243	106100209	204
07490402	334	101781102	145	101890309	206	105820203	183	106100308	204
07570039	334	101781201	145	101890408	206	105830103	187	106100407	204
07570054	334	101781300	145	101890507	206	105840102	176	106100506	204
07570104	334	101781409	145	101890606	206	105840201	176	106100605	204
07570203	334	101781508	145	101890705	206	105840227	176	106110109	205
08700106	221	101781557	145	101890804	206	105840243	176	106110208	205
100070024	231	101781607	145	101890903	206	105840268	176	106110307	205
100070050	231	101781706	145	101891000	206	105840300	176	106110406	205
100071090	228	101781805	145	101900108	254	105860100	253	106120108	205
100071100	230	101781904	145	101900207	254	105860308	253	106120207	205
100071200	230	101782001	145	101900306	254	105861108	253	106120306	205
100071300	230	101782100	145	101900405	254	105861207	253	106120405	205
100071500	230	101782209	145	101900504	254	105870059	182	106120504	205
100071550	230	101782308	145	101901007	254	105870109	182	106120603	205
100071600	230	101782407	145	101901106	254	105870208	182	106120702	205
100071907	228	101790053	187	101901205	254	105870307	182	106120801	205
100072004	230	101790103	187	101901304	254	105870406	182	106120900	205
100072045	230	101790202	187	101901403	254	105870505	182	106121007	205
100072188	229	101790301	187	101910107	254	105870604	182	106121106	205
100073050	231	101790400	187	101920106	225	105870703	182	106122005	205
100073120	231	101790509	187	101920205	225	105880058	244	106122104	205
100073300	231	101790608	187	101930105	225	105880108	244	106122203	205
100073500	229	101790707	187	101940104	226	105880207	244	106122302	205
100240100	204	101790806	187	101950103	226	105880306	244	106122401	205
100690106	115	101790905	187	102070109	136	105881106	244	106122500	205
100690106	248	101792000	187	102070208	136	105881205	244	106122807	205
101030203	98	101792109	187	102070307	136	105881304	244	106130107	206
101075145	1104	101792208	187	102070406	136	105881403	244	106130206	206
101530103	103	101792307	187	102070505	136	105900025	339	106130305	206
101540102	104	101792406	187	102070604	136	105900306	339	106130404	206
101540201	104	101792505	187	102070703	136	105900407	339	106130503	206
101660108	174	101792604	187	102070802	136	105910103	254	106130602	206
101670057	131	101800050	189	102070901	136	105930051	221	106130701	206
101670107	131	101800100	189	102080108	136	105930077	221	106130800	206

Order nr.	Pag.	Order nr.	Pag.	Order nr.	Pag.	Order nr.	Pag.	Order nr.	Pag.
106130909	206	109722306	172	112060306	134	1148660703	144	114920101	147
106131006	206	109722405	172	112060405	134	1148660802	144	114920200	147
106131105	206	109722504	172	112060504	134	1148660901	144	114920309	147
106140106	206	109722603	172	112060603	134	114870108	145	114920408	147
106140205	206	109722702	172	112060702	134	114870207	145	114930100	139
106140304	206	109722801	172	112070107	139	114870306	145	114930209	139
106140403	206	109722900	172	112070206	139	114870405	145	114930308	139
106140502	206	109730101	105	112070305	139	114870504	145	114930407	139
106140601	206	109730101	171	112070404	139	114870603	145	114930506	139
106140700	206	109730200	105	112070503	139	114870702	145	114930605	139
106141005	206	109730200	172	112070602	139	114870801	145	114930704	139
106141104	206	109740100	218	112070701	139	114870900	145	114930803	139
106141203	206	109740209	218	112070800	139	114871007	145	114930902	139
106141401	206	109750109	218	112070909	139	114872005	145	114931009	139
106141500	206	109750208	218	112260104	183	114872104	145	114931108	139
106141609	206	109750307	218	112260203	183	114872203	145	114931207	139
106150105	206	109760108	219	112270103	300	114872302	145	114931306	139
106150204	206	109770107	220	112280102	267	114872401	145	114931405	139
106150303	206	109770206	220	112280102	300	114872500	145	114931504	139
106160104	204	109770305	220	112290101	267	114872609	145	114931603	139
106160203	204	109780106	220	112310107	263	114872708	145	114931702	139
106170103	204	109780205	220	112310156	263	114872807	145	114960107	140
106180102	204	109790105	220	112310206	263	114872906	145	114960206	140
106180201	204	109800102	220	112310255	263	114873003	145	116480104	142
106180300	204	109820101	110	112310305	263	114873102	145	116480203	142
106190101	116	109820101	222	112310404	263	114880107	147	116480302	142
106210107	99	110100010	320	112440203	271	114880156	147	116480401	142
106230105	111	110100018	320	112520101	111	114880172	147	116480500	142
106230105	225	110100035	320	112520101	224	114880198	147	116480609	142
106280100	204	110100050	320	112540109	61	114880206	147	116480708	142
106281009	204	110100100	320	112550108	60	114880305	147	116480807	142
107540106	254	110100102	321	112680103	189	114880404	147	116480906	142
107540205	255	110100160	320	112680202	189	114880503	147	116481003	142
109070058	231	110100250	320	112680301	189	114880602	147	116481102	142
109070828	231	110100251	320	112680400	189	114880701	147	116481201	142
109090050	312	110100450	320	112680509	189	114880800	147	116490103	172
109090100	312	110380102	114	112680608	189	114880909	147	116490202	172
109090209	312	110380102	228	112680707	189	114881006	147	116490301	172
109100107	312	111730107	204	112680806	189	114881105	147	116490400	172
109290031	309	111730305	204	112680905	189	114881204	147	116490509	172
109290056	309	111730354	204	112700109	111	114890106	147	116490608	172
109290072	309	111730503	204	112700109	224	114890155	147	116490707	172
109290098	309	111730602	204	114590102	109	114890171	147	116490806	172
109290197	309	111960100	175	114590102	189	114890197	147	116490905	172
109420109	221	111960209	175	114590102	194	114890205	147	116491002	172
109420208	221	111960308	175	114640105	52	114890304	147	116491101	172
109450106	98	111960407	175	114820103	136	114890403	147	116491200	172
109460105	116	111960506	175	114820202	136	114890502	147	116500703	172
109460105	267	111960605	175	114820301	136	114890601	147	116500901	172
109470104	104	111960704	175	114820400	136	114890700	147	116510108	170
109470104	170	111960803	175	114820509	136	114890809	147	116510207	170
109480103	61	111960902	175	114820608	136	114890908	147	116510306	170
109550103	183	111961009	175	114820707	136	114891005	147	116510405	170
109550202	183	111961108	175	114820806	136	114891104	147	116510504	170
109600304	315	111990107	180	114830102	144	114900103	147	116510603	170
109690107	205	112010103	180	114830201	144	114900202	147	116510702	170
109690206	205	112010202	180	114830300	144	114900301	147	116510801	170
109690305	205	112010301	180	114830409	144	114900400	147	116510900	170
109690404	205	112010400	180	114830508	144	114900509	147	116511007	170
109690503	205	112010509	180	114830607	144	114900608	147	116520107	171
109720102	172	112010608	180	114830706	144	114900707	147	116560103	185
109720201	172	112010707	180	114830805	144	114900806	147	116560202	185
109720300	172	112010806	180	114830904	144	114900905	147	116560301	185
109720409	172	112010905	180	114840101	140	114901002	147	116560400	185
109720508	172	112011002	180	114840200	140	114901101	147	116560509	185
109720607	172	112012000	180	114840309	140	114901200	147	116560608	185
109720706	172	112012208	180	114840408	140	114901309	147	116560707	185
109720805	172	112020102	181	114840507	140	114901408	147	116560806	185
109720904	172	112020201	181	114840606	140	114901507	147	116560905	185
109721001	172	112020300	181	114840705	140	114901606	147	116561002	185
109721100	172	112030101	181	114840804	140	114901705	147	116561101	185
109721209	172	112030200	181	114840903	140	114901804	147	116561200	185
109721308	172	112030309	181	114841000	140	114901903	147	116561309	185
109721407	172	112030408	181	114841109	140	114902000	147	116561408	185
109721506	172	112030507	181	114860109	144	114910102	147	116561507	185
109721605	172	112030606	181	114860208	144	114910201	147	116561606	185
109721704	172	112040100	130	114860307	144	114910300	147	116561705	185
109722009	172	112040209	130	114860406	144	114910409	147	116561804	185
109722108	172	112060108	134	114860505	144	114910508	147	116561903	185
109722207	172	112060207	134	114860604	144	114910607	147	116562000	185

NUMERIEKE INDEX

Order nr.	Pag.	Order nr.	Pag.	Order nr.	Pag.	Order nr.	Pag.	Order nr.	Pag.
116562109	185	116830704	1114	117630103	223	121800070	336	123000152	315
116562208	185	116831009	1114	117690107	114	121800071	336	123040100	319
116562307	185	116831108	1114	117690107	249	121800125	336	127810109	320
116562406	185	116831207	1114	117690206	249	121870300	334	127810208	320
116570102	185	116831306	1114	117690305	249	121900100	338	127810307	320
116570201	185	116831405	1114	117730101	262	121900150	338	127810406	320
116570300	185	116831504	1114	117730200	262	121900200	338	127810505	320
116570409	185	116831603	1114	117730309	262	121900250	338	127810604	320
116570508	185	116840208	130	117760108	268	121900300	338	127810703	320
116570607	185	116860107	341	117780106	262	121900500	338	127810802	320
116570706	185	116930108	263	117860106	115	121901000	338	127810901	320
116570805	185	116940107	1115	117860106	248	121902000	338	127811008	320
116570904	185	116950106	264	117870105	247	121920500	339	127820108	320
116571001	185	116960105	264	117870204	247	121923000	339	127820207	320
116571100	185	116960204	264	117880104	60	121925000	339	128130101	113
116571209	185	116960303	264	117880203	60	121930300	339	128130101	141
116571308	185	116960402	264	117890301	263	121930500	339	128140100	146
116571407	185	116970104	264	117900100	246	121941519	339	128140209	146
116600107	187	116980103	248	117900209	246	121951115	339	128140308	146
116610104	165	116980202	248	117900308	247	121951519	339	128140407	146
116660101	163	116980301	248	118000108	262	121951923	339	128140506	146
116690058	143	116990201	245	118010107	262	121952030	339	128140605	146
116690108	143	117020107	243	118010206	262	121952327	339	128140704	146
116690207	143	117020206	243	118060102	129	121952731	339	128140803	146
116690405	143	117020305	243	118060201	129	121953070	339	128140902	146
116690504	143	117020404	243	118110105	248	121953135	339	128141009	146
116690603	143	117020503	243	118110204	248	121957011	339	128141108	146
116690702	143	117020602	243	118110303	248	122010150	329	128141207	146
116690801	143	117020909	242	118120203	203	122010200	329	128170107	312
116690850	143	117021006	242	118120302	203	122010250	329	128201001	129
116690900	143	117021105	242	118120401	203	122010300	329	128210101	107
116691007	143	117021204	243	118120500	203	122060106	200	128210101	128
116691106	143	117030106	244	118120609	203	122070105	132	128220100	112
116691205	143	117030205	244	118120708	203	122070204	132	128220100	132
116691304	143	117030304	244	118120807	203	122070303	132	128220100	212
116691403	143	117031005	244	118120906	203	122070402	132	128230109	124
116691502	143	117031104	244	118190107	262	122070808	132	128230109	179
116700105	106	117031203	244	118250109	252	122070857	132	128240108	124
116700105	176	117060103	99	118260108	253	122070907	132	128240108	168
116710104	176	117070102	163	118300102	180	122070956	132	128250107	107
116710203	176	117090209	163	118340108	128	122080104	113	128250107	183
116710302	176	117110106	131	118340108	204	122080104	141	128260106	124
116710401	176	117110205	131	118350107	140	122090103	101	128260106	186
116710500	176	117391151	129	118350206	140	122090103	130	128260205	124
116710609	176	117391250	129	118350305	114	122160104	55	128260205	186
116740051	143	117391409	129	118420108	140	122170103	56	128270105	124
116740085	143	117400101	138	118420108	262	122180102	57	128270105	189
116740101	143	117400200	138	118470103	60	122190101	55	128300100	226
116740200	143	117400309	138	118470103	269	122240104	61	128310109	226
116740309	143	117400408	138	118870104	140	122250103	61	128320108	226
116740333	143	117400507	138	118890102	103	122260102	244	128330107	125
116740358	143	117400606	138	118910108	165	122360100	53	128330107	222
116740382	143	117400705	138	119080208	333	122370109	54	128360104	227
116740408	143	117400804	138	119080257	333	122380109	58	128360203	227
116740507	143	117400903	138	119081008	334	122390107	77	128360302	227
116740606	143	117440107	138	119090108	311	122390113	79	128360401	227
116740705	143	117440206	138	119110104	322	122400104	75	128360500	227
116750050	144	117440305	138	119110203	322	122400104	82	128370103	227
116750084	144	117440404	138	119120103	322	122440100	114	128370202	227
116750100	144	117440503	138	119130102	323	122440100	246	128370301	227
116750209	144	117440602	138	119130201	323	122470107	114	128370400	227
116750308	144	117440701	138	119150100	321	122470107	228	128370509	227
116750357	144	117440800	138	119160109	321	122480106	111	128390101	229
116750407	144	117440909	138	119170108	321	122480106	225	128400108	258
116750506	144	117441006	138	119180107	327	122490105	112	128420106	238
116750605	144	117450106	139	119180206	327	122490105	212	128430105	115
116760059	218	117450205	139	119190106	331	122500101	111	128430105	258
116760158	218	117450304	139	120110075	326	122500101	200	128440104	117
116760208	218	117450403	139	120110100	326	122560105	315	128440104	258
116760307	219	117450502	139	120110150	326	122580103	331	128490109	258
116770158	220	117450601	139	120110200	326	122690100	185	128520103	258
116780107	225	117490102	110	120110250	326	122690209	185	128530102	258
116790106	268	117490102	223	120110300	326	122690308	185	128540101	258
116820101	232	117560102	60	120110400	326	122690407	185	128550100	258
116830100	1114	117570101	52	120110500	326	122690506	185	128560109	296
116830209	1114	117580100	223	120110750	326	122690605	185	128580107	293
116830308	1114	117590109	223	121700075	336	122690704	185	128590106	294
116830407	1114	117610105	223	121700100	336	122690753	185	128590205	295
116830506	1114	117610204	223	121700150	336	122690803	185	128600103	292
116830605	1114	117620104	223	121800045	336	122690902	185	128600202	295

Order nr.	Pag.	Order nr.	Pag.	Order nr.	Pag.	Order nr.	Pag.	Order nr.	Pag.
128600301	295	132440108	146	143880102	103	151300209	323	15580103	179
128650108	108	132440157	146	143930105	236	151300308	323	15610108	60
128650108	199	132440157	146	143930204	236	151340106	59	15610108	269
128650207	199	132440207	146	143930303	236	151350105	59	160380051	182
128650306	199	132440207	146	143930402	236	151410107	113	160380101	182
128650405	199	132440306	146	143930501	236	151410107	141	160380200	182
128650504	199	132440306	146	143980100	147	151420106	146	160380309	182
128650603	199	132440405	146	143980209	147	151420205	146	160390100	256
128650702	199	132440405	146	143980308	147	151420304	146	160690103	113
128650801	199	132440504	146	143990109	139	151420403	146	160690103	141
128650900	199	132440504	146	143990208	139	151420502	146	160700100	128
128651007	199	132440603	146	143990307	139	151420601	146	160700209	128
128651106	199	132440603	146	143990406	139	151420700	146	160700308	128
128651205	199	132440652	146	143990505	139	151420809	146	160701009	129
128651304	199	132440652	146	143990604	139	151430105	144	160701108	129
128660107	125	132440702	146	143990703	139	151430204	144	160701207	129
128660107	258	132440702	146	143990802	139	151430303	144	160720108	143
128670106	265	132440801	146	144000106	138	151430402	144	160720207	143
128670205	265	132440801	146	144000205	138	151430501	144	160720306	143
128680105	265	132450057	146	144000304	138	151430600	144	160720405	143
128690104	265	132450057	146	144000403	138	151430709	144	160720504	143
128700101	265	132450073	146	144000502	138	151440104	117	160730107	60
128710100	265	132450073	146	144000601	138	151460102	264	160740106	178
128720109	265	132450081	146	144000700	138	151460201	264	160740205	178
128730108	58	132450081	146	144020104	116	151460300	264	160740304	178
131490105	262	132450107	146	144020104	256	151460409	264	160740403	178
131560104	307	132450107	146	144030103	107	151460508	264	160740502	178
131890105	173	132450156	146	144030103	203	151470101	184	160740601	178
131890204	173	132450156	146	144030301	203	151470200	184	160740700	178
131890303	173	132450206	146	144040102	116	151480100	187	160740809	178
131890402	173	132450206	146	144050101	219	151520103	306	160740908	178
131890501	173	132450305	146	144050101	256	151520202	306	160741005	178
131890600	173	132450305	146	144070109	52	151520301	306	160741104	178
131890709	173	132450404	146	144080108	262	151520400	306	160741203	178
131890808	173	132450404	146	144080207	262	151540101	248	160741302	178
131890907	173	132450503	146	144100104	1115	151540200	248	160741401	178
131891004	173	132450503	146	14411003	343	151540309	248	160741500	178
131891103	173	132450602	146	144110103	180	151540408	248	160741609	178
131891202	173	132450602	146	144110202	180	151575145	1104	160741708	178
131900102	105	132450651	146	144110301	180	151590106	168	160741807	178
131900102	171	132450651	146	144110400	180	151590205	168	160741906	178
131910101	238	132450701	146	144110509	180	151590304	168	160750105	176
131920100	341	132450701	146	144110608	180	151590403	168	160750303	176
131920209	341	132450800	146	144110707	180	151590502	168	160750402	176
131920308	341	132450800	146	144110905	180	151590601	168	160750501	176
132090101	128	132460106	113	144111002	180	151610102	175	160750600	176
132150103	103	132460106	141	144120102	180	151610151	175	160750709	176
132180100	189	132470105	112	144130101	180	151610201	175	160750808	176
132180209	189	132470105	141	144140100	257	151610250	175	160750907	176
132180308	189	132680109	317	144290103	66	151610300	175	160751004	176
132180407	189	132720103	318	144300100	100	151610409	175	160751103	176
132180506	189	132720400	318	144310109	192	151620101	1136	160751202	176
132180605	189	132720509	318	144330107	355	151640109	174	160751301	176
132180704	189	132720608	318	144340106	100	151650108	177	160751400	176
132180803	189	139490106	312	144370103	116	151810108	182	160751509	176
132180902	189	139610109	53	144370103	267	151810207	182	160751608	176
132181009	189	143790103	54	144440104	68	151810306	182	160751707	176
132181108	189	143810109	129	144550100	315	151810405	182	160751806	176
132220104	263	143811008	129	144550209	315	151810504	182	160751905	176
132230103	142	143820108	129	144740107	236	152380101	311	160940102	143
132230202	142	143821007	129	144830106	322	152800108	130	161610100	187
132230301	142	143830107	129	144840105	322	153180104	307	161630106	56
132330101	314	143840106	112	144850104	307	153190103	307	161640107	56
132360108	316	143840106	141	144860103	297	153190202	307	161670104	118
132370107	306	143870012	210	144870102	296	153200100	325	161680103	118
132370206	306	143870020	210	144890100	297	153210109	308	161690102	119
132370305	306	143870038	210	144890209	297	153210208	308	161700109	119
132390105	355	143870046	210	145010104	297	153210307	308	161720107	120
132430109	144	143870053	210	149870107	142	153220108	294	161730106	119
132430208	144	143870061	212	149870206	142	153230107	327	161740105	121
132430307	144	143870087	212	149870305	142	154910103	168	161750104	121
132430406	144	143870103	212	149870404	142	154910202	168	161760103	120
132430505	144	143870202	212	149870503	142	154910301	168	161780101	98
132440058	146	143870301	212	151250107	327	155310105	1133	161780200	98
132440058	146	143870400	212	151250206	327	155310303	1133	161790100	98
132440074	146	143870657	213	151270105	331	155320104	1133	161790209	98
132440074	146	143870756	213	151280104	333	155420102	1132	161790308	98
132440082	146	143870806	213	151290103	333	155560204	424	161800107	99
132440082	146	143870905	213	151290202	333	155560303	424	161800206	99
132440108	146	143870954	213	151300100	323	155580103	424	161800305	99

NUMERIEKE INDEX

Order nr.	Pag.	Order nr.	Pag.	Order nr.	Pag.	Order nr.	Pag.	Order nr.	Pag.
161800310	228	167800200	300	173200108	259	174510107	125	177771300	195
161800406	424	167810100	300	17320102	345	174510107	194	177771409	195
161810056	210	167910108	355	17320409	345	174520106	125	177771508	195
161810106	210	167920107	150	17320607	345	174520106	201	177780103	195
162460208	325	167930106	152	17320805	345	174520205	125	177780202	195
162550107	165	168840106	113	17321209	345	174520205	201	177780301	195
162560106	164	168840106	613	17321258	345	174530105	223	177780400	198
162590103	131	168870103	612	17321308	345	174570101	157	177780459	195
162610109	131	168880102	612	17321605	345	174580100	158	177780467	195
162610208	131	168900108	309	17321803	345	174610204	60	177780475	195
162620108	54	168900116	309	17322009	345	174610204	269	177780483	195
162640106	184	168900124	309	173220104	253	174650101	132	177780491	195
162650105	187	168900132	309	173220203	253	174651000	132	177780509	195
162670103	184	168900207	309	173220302	253	174660100	60	177780608	195
162680102	173	17100108	300	17322405	345	174660209	60	177780707	195
162680201	173	172260101	249	17322454	345	174670109	60	177780806	198
162680300	173	172270100	264	173230103	265	174680108	60	177780905	195
162680409	173	172280109	203	173240102	255	174690107	60	177781002	195
162680508	173	172300105	200	173240201	255	177660107	185	177790102	196
162680607	173	172310104	355	173240300	255	177660206	185	177790201	196
162680706	173	172310302	355	173250101	255	177660305	185	177790300	196
162680805	173	172320103	120	173251006	255	177660404	185	177790409	196
162680904	173	172390106	202	173260100	334	177660503	185	177790508	196
162681001	173	172470106	156	17330101	344	177660602	185	177790607	196
162681100	173	172470205	151	17330200	344	177660701	185	177790706	196
162681209	173	172470304	154	17330309	344	177660800	185	177790805	196
166380105	345	172470403	117	17330408	344	177660909	185	177790904	196
166480103	345	172470403	144	17330507	344	177710100	253	177791001	196
166580100	331	172470403	265	17330606	344	177710209	253	177791100	196
166680108	259	172510109	147	17330705	344	177710308	253	177791209	196
166720102	105	172510109	265	17330804	344	177710407	253	177800109	196
166720102	171	172510208	147	17330903	344	177711009	253	177800208	196
166730101	107	172510208	265	173360108	155	177711108	253	177800307	196
166730101	182	172510307	147	173410101	255	177711207	253	177800406	196
166810101	121	172510307	265	173410200	255	177711306	253	177800505	196
166820100	53	172510406	147	173410309	255	177760105	195	177800604	196
166980102	188	172510406	265	173410408	255	177760204	195	177800703	196
166980201	188	172830101	187	173420209	495	177760303	195	177810108	196
166980300	188	172830200	187	173480107	330	177760402	195	177810207	196
166980409	188	172830309	187	17350109	344	177760501	195	177810306	196
166980508	188	172830408	187	17350208	344	177760600	195	177820107	196
166980607	188	172830507	187	17350307	344	177760709	195	177820206	196
166980706	188	172830606	187	17350406	344	177760808	195	177820305	196
166980805	188	172830705	187	17350505	344	177760907	195	177820404	196
166980904	188	172830804	187	17350604	344	177761004	195	177820503	196
166981001	188	172830903	187	17350703	344	177761103	195	177820602	196
166981100	188	172831000	187	17350802	344	177761152	195	177820701	196
167150101	170	172831109	187	17350901	344	177761202	195	177830106	196
167160100	170	172840100	146	174230102	314	177761301	195	177830205	196
167170109	168	172840209	146	174240101	323	177761400	195	177830304	196
167180108	168	172840308	146	174240200	323	177761509	195	177840105	197
167200104	153	172840407	146	174250050	335	177761558	195	177840204	197
167210103	154	172840506	146	174250209	332	177761608	195	177840303	197
167220102	159	172840605	146	174250209	335	177761657	195	177840402	197
167230101	159	172840704	146	174260109	332	177761707	195	177840501	197
167240100	156	172840803	146	174260109	335	177761756	195	177870102	201
167240209	156	172840902	146	174270108	299	177761806	195	177870201	201
167260108	152	172841009	146	174270207	299	177761905	195	177870250	201
167280106	153	172841108	146	174270306	299	177762002	195	177870300	201
167290105	151	172841207	146	174270405	299	177762101	195	177870409	201
167310101	152	172841304	146	174280107	301	177762200	195	177870508	201
167330109	150	172841306	146	174350108	110	177762259	195	177880101	201
167340108	150	172841403	146	174360107	110	177762309	195	177880200	201
167350107	150	172841405	146	174360107	222	177762408	195	177880309	201
167360106	202	172841502	146	174370106	108	177770104	195	177880408	201
167370105	161	172841601	146	174370106	194	177770203	195	177890100	202
167380104	160	172841700	146	174380105	108	177770302	198	177890209	202
167440106	59	172850109	300	174380105	194	177770401	195	177890308	202
167490200	134	172850208	300	174390104	109	177770500	195	177890407	202
167490309	134	173030107	265	174390104	201	177770609	198	177910205	257
167500206	117	173040106	254	174400101	108	177770708	195	177910304	257
167500206	310	173040205	253	174400101	194	177770757	195	177910403	257
167510106	162	173041005	254	174410100	109	177770807	195	177910502	257
167520105	162	173070103	254	174410100	194	177770831	195	177910601	257
167560101	324	173070202	254	174480103	116	177770856	195	177920105	257
167580109	157	173070301	254	174480103	253	177770906	195	177920204	257
167600105	131	173070400	254	174490102	109	177770955	195	177920303	257
167600204	131	173071002	254	174490102	197	177771003	195	177920402	257
167770106	298	173150103	52	174500108	109	177771102	195	177930104	257
167800101	300	173150202	52	174500108	194	177771201	195	177930203	257

Order nr.	Pag.	Order nr.	Pag.	Order nr.	Pag.	Order nr.	Pag.	Order nr.	Pag.
177930302	257	185830106	168	186311601	213	186890208	253	206040305	769
177930401	257	185830205	168	186311700	213	186900106	128	206040404	769
177940103	218	185830304	168	186311809	213	186900205	128	206060105	768
177940202	218	185840105	198	186311908	213	186900304	128	206060204	768
177940301	218	185860103	168	186312005	213	186901005	151	206060303	768
177950052	220	185870102	104	186312104	213	186901104	155	206090052	770
177950102	221	185870102	172	186312203	213	186910105	252	206090102	770
177950201	221	185880101	192	186312302	213	186910204	252	206090201	770
177950300	221	185890100	193	186312401	213	190110106	299	206090300	770
177960101	219	185900107	193	186312500	213	190120105	298	206140105	768
177960200	219	185910106	193	186312609	213	190140103	314	206140196	768
177960309	219	185920105	198	186312708	213	190140202	314	206140204	768
178020103	160	185930104	219	186312807	213	190140301	314	206150203	769
178180105	182	185930203	219	186312906	213	190170409	337	206150302	769
178180204	182	185970100	197	186313003	213	190180109	293	206150401	769
178180303	182	185990108	155	186313102	213	190370106	306	206190100	769
178180402	182	186100103	160	186313300	213	190380105	308	206190209	769
178180501	182	186110102	151	186313409	213	19070101	165	206240103	767
178200101	192	186140109	128	186313508	213	198620106	306	206240202	767
178200200	193	186140208	128	186313607	213	198640104	304	207330200	611
178200309	201	186140307	128	186360103	247	198650103	292	207370107	608
178210100	193	186150108	61	186360202	247	198660102	295	207390105	608
178210209	193	186160107	122	186370102	140	199610106	61	207830104	607
178390100	218	186200101	122	186380101	214	199620105	59	208260109	575
178610051	301	186220109	174	186400107	117	199640103	203	209920206	1086
178610200	301	186230108	221	186400107	254	199640103	351	209920305	1086
178620100	302	186230207	221	186430104	170	199650102	182	209920404	1086
178620209	304	186240107	229	186540209	214	199660101	355	209920503	1086
178631008	302	186250106	60	186540308	214	199680109	198	212140107	249
178640108	303	186260105	213	186540407	214	199680208	198	212140206	249
178660106	304	186260204	213	186540506	214	199680307	198	212240105	248
178670105	305	186260303	213	186550109	199	199780206	355	212240204	248
178680104	305	186280103	213	186560108	199	199790106	214	21460605	316
178690103	305	186280202	213	186590105	202	199810102	125	21461108	332
178700100	223	186280301	213	186590204	202	199810102	244	21461207	332
178710109	109	186300406	214	186590303	202	199820101	124	21461306	332
178710109	201	186300505	214	186610101	202	199820101	173	21461405	332
178720108	147	186300604	214	186640108	226	199830100	124	21469300	316
178720207	147	186300703	214	186640207	226	199830100	173	22490056	332
178760104	237	186300802	214	186640306	225	199910100	203	22490106	332
178760203	237	186300901	214	186640405	226	199910100	351	22490205	332
178760302	237	186301008	214	186650107	225	199910209	203	22490304	332
178760401	237	186301107	214	186650206	225	199910209	351	22490403	332
178760500	237	186301206	214	186650305	226	199910308	198	22550107	316
178761003	236	186301305	214	186650404	226	200570109	305	22590103	324
178770103	238	186301404	214	186650503	226	200580108	295	22590200	324
178770202	238	186301503	214	186650602	226	200820207	941	22590300	324
178770301	238	186301602	214	186660106	268	200820207	1086	22590400	324
178770400	238	186301701	214	186670105	229	200820306	941	22590500	324
178770509	238	186301800	214	186680104	229	200820306	1086	22720205	321
178780102	238	186301909	214	186710109	256	200820405	941	22890107	315
178780201	238	186302006	214	186710208	256	200820405	1086	22890156	315
178780300	238	186302105	214	186710307	256	200830404	1086	22890172	315
178780409	238	186302204	214	186720109	142	200830503	1086	22890206	315
178780607	238	186302303	214	186730107	139	200850600	941	22899000	315
178790051	136	186302402	214	186730206	139	200850600	1086	22899150	315
178790101	136	186302501	214	186730305	139	20090106	252	22940100	321
178790309	136	186302600	214	186740106	105	20090205	252	23040108	314
178790507	136	186302709	214	186740106	171	20090304	252	23040207	314
178790606	136	186302808	214	186750105	105	205150105	184	23040306	314
178790705	136	186302907	214	186750105	171	205630106	184	23040405	314
178790804	136	186303004	214	186770103	255	205710106	665	23041012	314
178790903	136	186303103	214	186780102	106	205720204	611	23041015	314
178791000	136	186303202	214	186780102	175	205930100	766	23041520	314
178791109	103	186303301	214	186790101	176	205930308	766	23042020	314
178801007	117	186303400	214	186790200	176	205930407	766	23045009	314
178801007	133	186303509	214	186790309	176	205930506	766	23045008	307
178810107	120	186303608	214	186790317	176	205940208	766	23045015	314
178830105	123	186310405	213	186790325	176	205940307	766	230460107	307
178840104	118	186310504	213	186790408	176	205960107	767	230470106	343
178850103	119	186310603	213	186790507	176	205960305	767	23050057	313
178860102	123	186310702	213	186790606	176	205960404	767	23050206	313
178870101	121	186310801	213	186790655	176	205960503	767	23050404	313
181120106	305	186310900	213	186790705	176	206030207	767	23050503	313
181120205	305	186311007	213	186810107	130	206030306	767	23051020	313
185800109	102	186311106	213	186820106	229	206030405	767	23051030	313
185810108	177	186311205	213	186870101	60	206030504	767	23051050	313
185810207	177	186311304	213	186870101	269	206030603	767	23051220	313
185820107	174	186311403	213	186880100	253	206040107	769	23051230	313
185820206	174	186311502	213	186890109	253	206040206	769	23051520	313

NUMERIEKE INDEX

Order nr.	Pag.	Order nr.	Pag.	Order nr.	Pag.	Order nr.	Pag.	Order nr.	Pag.
23051530	313	231730706	185	237690706	136	24391005	329	25319100	326
23052006	313	231730805	185	237690805	136	24391104	329	25319125	326
23052020	313	231730904	185	237690904	136	24399010	329	25319150	326
23052030	313	231740101	183	237710108	133	24399020	329	25319200	326
23052508	313	231750100	186	237720107	108	24399030	329	25319250	326
23053010	313	231750209	186	237720107	203	24399040	329	25319300	326
23053015	313	231750308	186	237730106	125	24400509	329	25331505	325
23053020	313	231750407	186	237730106	206	24400707	329	25331604	325
23054010	313	231750506	186	237740105	206	24409010	329	25331703	325
23054012	313	231750605	186	237740204	206	24409020	329	25331802	325
23054015	313	231750704	186	237740303	206	24409030	329	25331901	325
23055020	313	231750803	186	237740402	206	24409040	329	25332008	325
23055025	313	231750902	186	237740501	206	24409050	329	25339250	325
23056015	313	231760109	186	237740600	206	24430407	329	25339500	325
23056020	313	231770108	186	237760103	410	24430506	329	25341000	326
23056030	313	231780107	188	237760202	410	24430704	329	25341500	326
23058020	313	231790106	186	237760301	410	24439005	329	25342000	326
23058030	313	231790205	186	237770102	327	24439010	329	25342007	326
23058040	313	231790304	186	237770201	327	24439020	329	25342106	326
230590101	310	231790403	186	237780101	327	24439030	329	25342205	326
230860108	303	231790502	186	237780200	327	24439040	329	25342304	326
231330101	158	231790601	186	237780309	327	24440406	329	25342500	326
231360108	145	231790700	186	237790100	327	24440505	329	25343000	326
231370107	130	231790809	186	237840103	58	24449010	329	25344000	326
231380106	140	231790908	186	237860101	243	24449020	329	25380304	325
231380205	140	231800103	188	237870100	239	24449030	329	25380502	325
231380304	140	231800202	188	237870209	239	24449040	329	25380700	325
231380403	140	231800301	188	237880109	410	24449050	329	25380809	325
231410101	176	231800400	188	23790108	328	24449060	329	25381005	325
231410200	176	231800509	188	23790207	328	24450405	329	25381104	325
231410309	176	231800608	188	237920103	245	24450504	329	25389010	325
231411000	177	231800707	188	237930102	335	24450702	329	25389020	325
231420100	132	231800806	188	237930201	335	24459010	329	25389030	325
231420209	132	231800905	188	237980107	335	24459020	329	25389040	325
231420308	132	231810102	184	237980206	335	24459030	329	25389050	325
231420407	132	231810201	184	237980305	335	24459040	329	25389060	325
231421009	132	231810300	184	237980404	335	24459050	329	25410200	327
231430109	145	231810409	184	237980503	335	24690109	345	25410309	327
231440108	227	231810508	184	237980602	335	24741001	330	25410408	327
231440207	227	231810607	188	237980701	335	24750101	330	25419010	327
231440306	227	231840109	245	23799010	328	24820201	330	25419020	327
231440405	227	231840208	245	237990106	336	24821001	330	25419600	327
231440504	227	231840406	245	237990205	336	24850109	330	25419800	327
231440603	227	231840505	245	237990304	336	24850208	330	25420209	326
231440702	227	231850108	246	237990403	336	25020108	336	25429100	326
231440801	227	231850207	245	237990502	336	25020207	336	25429150	326
231440900	227	231860107	243	237990601	336	25020405	336	25429250	326
231441106	227	231860206	243	237990700	336	25020603	336	25429300	326
231450107	227	231860305	243	237990809	336	25050204	340	25449010	326
231450206	227	231860404	243	238000103	336	25050501	340	25449020	326
231450305	227	231860503	243	238000202	336	25050600	340	25450100	326
231450404	227	231860602	243	238000301	336	25050709	340	25450125	326
231470105	341	231860701	243	238000400	336	25059000	340	25455000	326
231470204	341	231860800	243	238040109	55	25059011	340	25456000	326
231470303	341	231860909	243	238060107	495	25059012	340	25457500	326
231470402	341	231861006	243	238060206	495	25059013	340	25480104	331
231470501	341	231861105	243	238070106	495	25059015	340	25480203	331
231490103	227	231861204	243	238070205	495	25060104	340	25480302	331
231490202	227	231861303	243	23940109	312	25060302	340	25480401	331
231490301	227	231861402	242	23949900	312	25060500	340	25489010	331
231490400	227	231861501	243	24130205	328	25060609	340	25489020	331
231500109	227	231870106	246	24130304	328	25060807	340	25490103	331
231500208	227	231890104	102	24200107	328	25069010	340	25500109	331
231500307	227	233810100	314	24202004	328	25069020	340	25500208	331
231590100	212	233810209	314	24202103	328	25069030	340	25500406	331
231600107	200	233810308	314	24202202	328	25069040	340	25650102	337
231610106	206	233820109	337	24202301	328	25070103	339	25670100	133
231610205	206	233830108	298	24280109	328	25070202	339	25670159	133
231610304	206	233840107	308	24280208	328	25070301	339	25670209	133
231610403	206	23630106	345	24290207	329	25070400	339	25670258	133
231610502	206	23630205	345	24290405	329	25070509	339	25670308	133
231610601	206	23630304	345	24290702	329	25070608	339	25670407	133
231610700	206	237660105	102	24290801	329	25070707	339	25670506	133
231620105	215	237670104	165	24291007	328	25071507	339	25670605	133
231730102	185	237690102	136	24299010	329	25071606	339	25670704	133
231730201	185	237690201	136	24299020	329	25071705	339	25670803	133
231730300	185	237690300	136	24299030	329	25071804	339	25670902	133
231730409	185	237690409	136	24360208	328	25071903	339	25671009	133
231730508	185	237690508	136	24390502	329	25072000	339	25690108	337
231730607	185	237690607	136	24390700	329	25072109	339	25730102	137

Order nr.	Pag.	Order nr.	Pag.	Order nr.	Pag.	Order nr.	Pag.	Order nr.	Pag.
25730201	137	25992900	342	27970805	309	36200905	139	58340209	228
25730300	137	26000109	342	28000107	309	36201002	139	58340308	228
25730409	137	26210054	135	28000305	309	36201101	139	58890104	345
25730508	137	26210104	135	28000404	309	36201200	139	58890203	345
25730607	137	26210203	135	28130102	164	36201309	139	58890302	345
25730706	137	26210302	135	28130201	164	36201408	139	60060100	310
25730805	137	26210401	135	28930105	61	36512309	259	60190600	333
25730904	137	26210500	135	28930154	61	36513109	259	60191004	333
25731001	137	26210609	135	28930170	61	36513208	259	60600103	269
25731100	137	26210708	135	28930204	61	36513307	259	61180207	204
25731209	137	26210807	135	28930303	61	37300100	268	61180207	351
25731308	137	26210906	135	28930402	61	37300209	268	61380101	327
25731407	137	26211003	135	29960101	131	38190054	165	61931002	320
25731506	137	26211102	135	34860106	132	38190104	165	61931101	320
25731605	137	26211201	135	34860205	132	39180104	101	61931200	320
25731704	137	26211300	135	34960054	224	39180203	101	61931309	320
25731803	137	26211409	135	34960104	224	39820055	133	61931408	320
25732009	138	26211508	135	34960153	224	39820105	133	62460100	61
25732108	138	26243006	319	34960179	224	39820121	133	62571005	134
25732207	138	26243105	319	34960203	224	39820154	133	62571104	134
25732306	138	26243204	319	34960302	224	39820204	133	62571203	134
25732405	138	26243303	319	35020056	224	39820303	133	62571302	134
25732504	138	26243402	319	35020106	224	43970201	323	62571401	134
25732603	138	26243501	319	35020155	224	44280105	110	62571500	134
25732702	138	26243600	319	35020171	224	44280105	222	63090104	249
25751009	343	26243709	319	35020205	224	51750107	344	63090203	249
25751108	343	26390104	338	35020304	224	51750206	344	65610206	344
25771007	343	26390300	338	35620038	133	51750305	344	65610404	344
25801002	343	26390301	338	35620061	133	51750404	344	65611105	344
25801101	343	26410209	343	35620095	133	51750503	344	65611106	344
25801200	343	26430108	316	35620103	133	51750602	344	67921106	342
25801309	343	26430207	316	35620202	133	51750701	344	67921205	342
25801408	343	26430405	316	35620301	133	51760106	344	68200104	138
25841008	343	26430504	316	35620350	133	51760205	344	68200203	138
25841107	343	26450106	316	35620400	133	51760304	344	68200302	138
25841206	343	26450205	316	35620459	133	51760403	344	68200401	138
25861006	341	26460105	298	35620509	133	51760502	344	68200500	138
25900309	341	26510107	316	35620608	133	51760601	344	68200609	138
25950601	342	26510131	317	35630102	131	51760700	344	68200708	138
25951104	342	26510164	317	35640101	131	52090107	340	68200807	138
25952003	342	26510206	317	35640200	131	52090206	340	68200906	138
25952102	342	26510305	317	35640309	131	52090305	340	68201003	138
25952201	342	26510404	317	35650050	131	52090404	340	68250109	138
25953001	342	26540203	310	35650100	131	52171402	326	68250208	138
25953100	342	26700302	311	35650209	131	52380102	333	68250307	138
25953209	342	26700708	311	35650308	131	52430105	333	68250406	138
25953308	342	27020106	338	35650407	131	52520202	336	68250505	138
25953407	342	27020205	338	35680107	267	52520301	336	68250604	138
25953506	342	27020304	338	35810100	131	52520400	336	68250703	138
25953605	342	27020403	338	35810209	131	52530102	330	68250802	138
25959014	342	27020502	338	35860055	135	52530201	330	68250901	138
25959015	341	27020601	338	35860105	135	52539010	330	68260058	134
25959100	337	27030055	338	35860154	135	52700309	311	68260108	134
25959102	337	27030105	338	35860204	135	52709200	311	68260207	134
25959103	337	27030204	338	35860253	135	52709300	311	68260306	134
25959104	337	27030303	338	35860303	135	52720109	338	68280106	134
25959105	337	27050608	339	35860402	135	52720208	338	68280205	134
25959106	337	27100106	345	35860451	135	52720307	338	68280304	134
25971003	342	27100155	345	35860477	135	52720406	338	68350107	134
25990102	342	27100171	345	35860493	135	52910106	334	68350206	134
25990201	342	27100205	345	35860501	135	52910205	334	68350305	134
25990300	342	27100254	345	35860550	135	52910304	334	68610104	100
25990409	342	27100304	345	35860600	135	52910403	334	68761015	313
25990508	342	27109010	340	35860709	135	52910502	334	68761020	313
25990607	342	27109011	340	35860808	135	52910601	334	68761030	313
25990706	342	27109012	340	35860907	135	52910700	334	68761220	313
25990805	342	27109013	340	35870104	130	53070108	298	68761230	313
25990904	342	27109014	340	35870153	130	53180204	323	68761520	313
25991308	342	27109015	340	35870179	130	53180303	323	68761530	313
25991506	342	27560101	104	35870203	130	53181004	323	68762006	313
25991605	342	27560101	169	35870302	130	53181103	323	68762020	313
25991704	342	27560200	169	35880202	52	53181202	323	68762508	313
25991902	342	27970102	309	36200103	139	53181301	323	68763009	313
25992009	342	27970300	309	36200202	139	53360103	299	68763010	313
25992108	342	27970409	309	36200301	139	53360202	299	68763015	313
25992207	342	27970557	309	36200400	139	53370102	299	68763020	313
25992405	342	27970607	309	36200509	139	53380101	300	68764010	313
25992504	342	27970615	309	36200608	139	53700100	342	68764012	313
25992702	342	27970623	309	36200707	139	58050303	104	68764015	313
25992801	342	27970706	309	36200806	139	58050303	169	68764020	313

NUMERIEKE INDEX

Order nr.	Pag.	Order nr.	Pag.	Order nr.	Pag.	Order nr.	Pag.	Order nr.	Pag.
68765015	313	69940609	61	711700117	772	712089001	659	712112123	603
68765020	313	69940708	61	711803001	618	712089003	659	712112124	603
68765025	313	69950103	135	712000080	633	712089100	660	712112125	603
68766015	313	69950202	135	712000100	633	712089102	660	712112130	603
68766020	313	69950301	135	712001210	635	712089104	660	712112150	604
68766030	313	69950400	135	712001230	632	712089106	660	712115608	602
68768015	313	69950509	135	712001235	632	712089108	660	712316000	665
68768020	313	69950608	135	712001237	634	712089131	661	712316001	664
68768030	313	69950707	135	712001245	634	712089133	661	712316060	664
68768040	313	69950806	135	712002222	635	712089136	661	712316061	664
68800101	113	69950905	135	712002241	636	712089138	661	712316070	664
68800101	141	69951002	135	712003326	636	712089141	661	712316080	664
68830108	163	69970101	135	712003331	637	712089143	661	712316200	665
68830207	163	69970200	135	712003650	637	712100001	418	712316201	664
68840107	164	69970309	135	712005261	638	712100001	602	712316260	664
68850106	101	69970408	135	712005291	640	712100002	418	712316261	664
68860105	102	69970507	135	712005300	640	712100002	602	712316270	664
68870104	103	69970606	135	712005301	638	712101050	617	712316280	664
68910108	104	69970705	135	712005310	638	712101052	617	712316300	665
68910108	169	69970804	135	712005361	640	712101260	617	712316360	664
68910157	106	69970903	135	712005400	641	712101261	617	712316370	664
68910157	174	701303641	178	712005500	642	712101265	617	712400100	606
68910207	104	701304146	178	712005531	641	712101267	617	712401100	610
68910207	173	701304650	178	712005553	641	712101400	618	712401220	610
68920107	107	701611020	178	712006530	642	712101401	618	712401260	610
68920107	189	701611030	178	712007411	647	712101412	618	712401310	611
68930106	107	701611040	178	712007421	647	712101415	618	712401350	611
68930106	186	701611050	178	712007623	648	712101420	618	712401400	610
68930205	107	701611060	178	712008312	643	712101425	618	712401420	610
68930205	186	701611070	178	712009410	646	712101600	618	712401440	610
68940105	197	701611080	178	712009413	643	712101601	618	712401450	610
68940139	198	701611090	178	712009414	643	712101614	618	712401500	611
68940162	198	701611100	178	712009430	646	712101617	618	712401510	611
68940204	198	701611110	178	712009432	647	712101620	618	712401520	611
68940303	198	701611120	178	712009433	643	712101622	618	712401550	612
68940402	198	701611130	178	712009530	646	712102006	604	712402101	613
68940501	198	701611150	177	712009531	648	712102008	604	712402200	613
68940600	198	701611170	177	712009731	648	712102100	603	712402219	613
68940709	198	701611180	178	712009831	649	712102110	603	712402227	613
69060101	355	701611190	178	712009832	649	712102125	603	712402239	613
69070100	232	701611200	178	712018410	649	712102130	604	712402243	613
69110104	243	701611210	178	712018430	649	712102170	604	712402300	613
69190106	115	701611220	178	712018530	649	712102190	604	712402381	613
69190106	1110	701611230	178	712018531	650	712102200	619	712402382	613
69210102	116	703311117	168	712018731	650	712102210	619	712402383	613
69220101	117	703311120	168	712018734	650	712102220	619	712402384	613
69220101	243	704302528	175	712018735	650	712102230	423	712402400	613
69340107	115	704303236	175	712018831	650	712102250	607	712402500	613
69340107	264	704303641	175	712018832	650	712102260	607	712402600	609
69360105	252	704304146	175	712022273	652	712102270	607	712402620	609
69360204	252	704304650	175	712022275	652	712102290	607	712402640	609
69509010	311	704311112	175	712022283	652	712102300	605	712402700	609
69790103	133	704311214	175	712024712	657	712102350	605	712403120	616
69790202	133	704311415	175	712024752	658	712102500	605	712403150	617
69790301	133	704311416	175	712024812	657	712102600	605	712403152	617
69800100	133	704311517	175	712024852	658	712102605	605	712403158	617
69800209	133	704311920	175	712024912	657	712102700	606	712403190	608
69800308	133	704312108	174	712025012	657	712102800	606	712403200	608
69800407	133	704312112	174	712025712	657	712102803	605	712403210	617
69800506	133	704312122	175	712025753	654	712102850	606	712403250	609
69800605	133	704312325	175	712025753	656	712102860	606	712403280	615
69800704	133	704312631	175	712025813	653	712102900	605	712403290	614
69800803	133	704312833	175	712025815	653	712103010	605	712403291	616
69800902	133	704313033	175	712025853	654	712103100	619	712403450	614
69890101	133	704316080	175	712025853	656	712104110	619	712403470	609
69890150	133	704319011	175	712025915	653	712105200	416	712403490	617
69890200	133	705301113	175	712025955	654	712105420	602	712403500	614
69890259	133	705301315	175	712025955	656	712105520	602	712403504	615
69890309	133	705301317	175	712026015	653	712105610	602	712403506	615
69890358	133	705301417	175	712027055	655	712105650	602	712403508	615
69890408	133	705301517	175	7120270551	655	712105703	602	712403510	615
69890507	133	705301922	175	7120270651	655	712105850	602	712403512	615
69890606	133	705311112	175	712027065	655	712105854	602	712403520	614
69940104	61	705311416	175	712028752	651	712105910	602	712403600	614
69940203	61	709000029	245	712028753	651	712105950	602	712403700	616
69940252	61	709000032	245	712029711	652	712106001	616	712403708	614
69940278	61	709000044	178	712029911	652	712106002	616	712403712	614
69940302	61	710000003	1108	712053072	665	712106050	602	712403718	614
69940401	61	711600305	357	712053074	665	712112120	603	712403750	616
69940500	61	711690100	764	712081664	659	712112122	603	712403758	614

Order nr.	Pag.	Order nr.	Pag.	Order nr.	Pag.	Order nr.	Pag.	Order nr.	Pag.
712403762	614	713034508	994	713107275	863	713352017	1105	713357458	1152
712403800	615	713050571	1087	713107320	863	713352018	1105	713357511	1158
712403810	615	713050572	1087	713107321	863	713352019	1105	713357514	1157
712403815	615	713050573	1087	713107330	863	713352022	1118	713357515	1157
712403820	615	713050574	1087	713107331	863	713352025	1118	713357518	1157
712403825	615	713050585	1087	713244028	811	713352029	1118	713357519	1157
712403830	616	713050587	1087	713244030	811	713352031	1104	713357520	1157
712403835	616	713050608	1086	713290290	910	713352032	1104	713357521	1157
712403840	615	713050610	1086	713290295	910	713352035	1118	713357522	1157
712403845	616	713050623	1086	713290335	912	713352036	1118	713357524	1158
712403850	616	713050626	1086	713290350	914	713352042	1099	713357525	1158
712403860	616	713050630	1086	713292355	916	713352052	1090	713357526	1158
712403865	616	713050636	1089	713300070	888	713352053	1090	713357528	1158
712404100	607	713050637	1089	713300075	889	713352054	1090	713357529	1158
712404150	607	713050656	1086	713300100	890	713352055	1090	713357530	1160
712404170	614	713050657	1086	713300131	894	713352069	1088	713357531	1161
712404190	607	713050658	1087	713300150	895	713352070	1088	713357532	1161
712404220	614	713050659	1087	713300182	898	713352102	1093	713357538	1156
712404450	609	713050660	1087	713300186	898	713352113	1120	713357540	1160
712404550	609	713050661	1087	713300210	896	713352127	1117	713357541	1160
712404660	609	713050663	1088	713300212	896	713352128	1117	713357542	1160
712404800	609	713050664	1088	713300260	900	713352129	1117	713357543	1160
712404850	608	713050665	1088	713300265	900	713352393	1118	713357609	934
712500011	665	713050666	1088	713300280	902	713352394	1118	713357612	1166
712500014	665	713050667	1088	713300285	904	713352999	1001	713357614	1166
712502102	664	713050668	1088	713302275	881	713353000	1001	713357616	1166
712502104	664	713050669	1087	713302300	881	713353006	1007	713357618	1166
712502132	664	713050670	1087	713310305	864	713353009	1003	713357622	1167
713000008	1100	713050675	1087	713311071	866	713353020	1104	713357624	1167
713000010	1100	713050676	1087	713334400	992	713353022	1104	713357626	1167
713000012	1100	713051002	1142	713334403	990	713353024	1104	713357628	1167
713000015	1100	713051003	1142	713336006	1012	713353025	1104	713357642	1167
713000020	1100	713051004	1137	713336048	1010	713353026	1104	713357644	1167
713000075	1100	713051015	1110	713336088	1014	713353028	1104	713357646	1167
713000100	1100	713051026	1144	713336110	1016	713354001	337	713357648	1167
713000125	1100	713051057	1110	713336120	1018	713354100	1102	713357672	1170
713000150	1100	713051063	1144	713338120	1000	713354110	1103	713357674	1170
713000210	1101	713060005	1149	713338122	1000	713354120	1103	713357676	1170
713000214	1101	713060024	1149	713338125	1000	713354125	1102	713357678	1170
713000220	1101	713060025	1149	713338155	1002	713354130	1103	713357682	1166
713000230	1101	713060026	1149	713338160	1004	713354150	1102	713357684	1166
713000234	1101	713060028	1149	713338450	1006	713354165	1107	713357686	1166
713000240	1101	713060030	1149	713338460	1008	713354170	1102	713357688	1166
713003171	948	713060032	1149	713338465	1008	713354175	1102	713357751	1159
713003231	949	713060044	1149	713346140	1020	713354178	1102	713357752	1159
713003233	949	713060045	1149	713346240	1022	713354200	1102	713357753	1159
713003261	964	713060046	1149	713350212	1121	713354217	1101	713357801	1172
713003263	964	713060048	1149	713350213	1121	713355100	1103	713357832	1172
713003331	966	713060050	1149	713350214	1121	713355127	1103	713357834	1172
713003333	966	713060052	1149	713350215	1121	713355150	1103	713357836	1172
713008131	944	713100110	872	713350216	1121	713355200	1103	713357838	1172
713008141	945	713100115	872	713350220	1121	713355500	1103	713357854	1172
713008161	946	713100121	873	713350221	1121	713356100	1106	713357856	1172
713008201	947	713100125	873	713350508	1093	713356110	1105	713357858	1172
713008203	947	713100126	872	713351010	1109	713356125	1107	713357860	1172
713008251	960	713100127	872	713351021	1109	713356150	1105	713357862	1172
713008253	960	713101505	859	713351026	1109	713356152	1106	713357865	1172
713008321	962	713101510	859	713351027	1109	713356154	1105	713381016	1119
713008323	962	713101515	859	713351106	1155	713356155	1106	713381018	1119
713009161	996	713101520	859	713351109	1156	713356157	1106	713383851	933
713009181	996	713101525	859	713351110	1156	713356200	1105	713383851	1077
713020217	950	713101540	861	713351114	1155	713356205	1106	713383852	933
713020218	952	713101545	861	713351131	1108	713356225	1106	713383852	1077
713020241	951	713101550	861	713351145	1108	713356254	1105	713383853	933
713020243	951	713101570	860	713351152	1108	713356365	1106	713383853	1077
713020245	956	713101575	860	713351160	1108	713356591	1104	713383854	933
713020281	968	713101580	860	713351490	890	713356595	1104	713383854	1077
713020283	968	713107050	862	713351509	1156	713356596	1104	713383975	1076
713020285	972	713107100	862	713351511	1156	713356600	1104	713383978	1076
713020333	970	713107101	862	713351512	1156	713356660	1135	713383979	1076
713020335	974	713107103	862	713351513	1155	713356663	1135	713384020	1076
713020420	954	713107150	863	713351514	1155	713357001	933	713384108	1077
713020430	976	713107155	863	713351518	1156	713357002	933	713384110	1077
713020440	978	713107180	863	713351522	1156	713357003	933	713384112	1077
713034220	958	713107185	863	713351980	1090	713357004	934	713384117	1077
713034230	982	713107210	863	713352001	1135	713357444	1152	713384122	1077
713034240	984	713107215	863	713352002	1135	713357446	1152	713384127	1077
713034245	980	713107250	863	713352014	1090	713357448	1152	713384132	1077
713034340	986	713107255	863	713352015	1105	713357454	1152	713384137	1077
713034345	988	713107270	863	713352016	1105	713357456	1152	713384142	1077

NUMERIEKE INDEX

Order nr.	Pag.	Order nr.	Pag.	Order nr.	Pag.	Order nr.	Pag.	Order nr.	Pag.
713384147	1077	713441415	1119	713621316	883	713661211	935	713780012	823
713384152	1077	713441460	1119	713621350	884	713661212	935	713780618	831
713384157	1077	713441461	1119	713621351	884	713661213	935	713781301	832
713384162	1077	713441508	1122	713623350	886	713661214	935	713790006	809
713384167	1077	713441509	1093	713625400	887	713661215	935	713800018	668
713384172	1077	713441554	1097	713625401	887	713661216	935	713800021	668
713384177	1077	713441556	1097	713625402	887	713661217	935	713800024	668
713384182	1077	713441558	1097	713630105	891	713661218	935	713800026	668
713384187	1077	713441610	1123	713630125	892	713661221	935	713800027	668
713384192	1077	713441617	1124	713630150	893	713661222	935	713800029	668
713384197	1077	713441623	1125	713642571	887	713661223	935	713800030	668
713384202	1077	713441640	1122	713643171	887	713661224	935	713800038	668
713384225	1077	713441641	1123	713650011	1156	713661225	935	713812031	824
713384240	1077	713441650	1124	713650012	1156	713661226	935	713812035	826
713384252	1077	713441662	1122	713650013	1156	713661227	935	713812036	828
713384267	1077	713441664	1122	713650014	1156	713661228	935	713813103	833
713384294	1077	713441666	1123	713650015	1156	713661311	935	713813201	834
713384295	1077	713441668	1123	713650016	1156	713661312	935	713813202	834
713384300	1077	713441670	1124	713650400	1153	713661313	935	713813203	834
713385101	317	713441672	1125	713652250	1152	713661314	935	713813204	834
713386200	1120	713441674	1126	713652251	1152	713661315	935	713813301	835
713400928	1054	713441701	1129	713652252	1152	713661316	935	713813302	835
713402030	1040	713441702	1127	713652253	1152	713661317	935	713813303	835
713402040	1040	713441703	1131	713652254	1152	713661318	935	713813314	836
713402045	1040	713441704	1128	713652504	1152	713661321	935	713813315	836
713402050	1042	713441705	1127	713652505	1152	713661322	935	713813316	836
713402060	1042	713441725	1131	713652506	1152	713661323	935	713813317	836
713402070	1044	713441726	1131	713652754	1152	713661324	935	713813318	836
713402080	1044	713441727	1131	713652756	1152	713661325	935	713813319	836
713402159	1058	713441750	1126	713652758	1152	713661326	935	713814001	830
713402209	1058	713441751	1127	713653004	1152	713661327	935	713814002	830
713420260	1026	713441752	1130	713653006	1152	713661328	935	713819040	840
713420310	1028	713441753	1130	713653008	1152	713680012	918	713819045	842
713420320	1030	713441754	1127	713653154	1152	713680013	906	713819055	846
713420325	1030	713441755	1128	713653156	1152	713690026	908	713819060	844
713420350	1032	713441756	1129	713653158	1152	713690041	920	713840231	878
713420353	1032	713441758	1126	713653504	1152	713690055	922	713849314	879
713420355	1032	713441759	1130	713653506	1152	713700051	865	713850010	1085
713425001	1034	713441760	1129	713654048	1153	713721004	1166	713850231	1152
713425003	1034	713441761	1128	713654049	1153	713721006	1166	713850232	1152
713425006	1034	713441762	1129	713655000	1160	713721008	1166	713850233	1152
713427001	1036	713441763	1128	713655001	1163	713721010	1166	713853502	1152
713427003	1036	713441808	1122	713655005	1163	713722080	1171	713853503	1152
713427006	1036	713461168	1056	713655013	1160	713722101	869	713853504	1152
713427200	1038	713461169	1056	713655020	1155	713722128	1171	713860300	940
713427205	1038	713462110	1046	713655021	1155	713722612	1169	713860350	937
713440210	1119	713462120	1046	713655022	1155	713722640	1169	713860351	936
713440211	1119	713462125	1048	713655023	1155	713722660	1169	713860500	938
713440230	1119	713462130	1046	713655024	1155	713723050	871	713860502	938
713440231	1119	713462160	1050	713655100	1160	713723051	871	713860754	939
713440281	1097	713462170	1050	713655101	1163	713723052	871	713861204	939
713440305	1097	713462175	1052	713655105	1163	713723053	871	713867504	941
713440360	1119	713462180	1050	713655115	1160	713723054	871	713876001	941
713440361	1119	713462720	1060	713655116	1160	713723055	871	713876004	941
713440505	1097	713462730	1060	713655200	1160	713723056	871	713876005	941
713440506	1097	713462782	1062	713655201	1163	713723057	871	713876020	941
713440653	1096	713462783	1062	713655205	1163	713723058	871	713877351	941
713440653	1124	713500410	1064	713655206	1160	713723059	871	713877502	941
713440654	1096	713500430	1066	713655208	1159	713723060	871	713880080	825
713440654	1125	713501080	1068	713655509	1159	713723061	871	713880081	825
713440655	1097	713501105	1070	713655604	1159	713723062	871	713880085	825
713440655	1125	713504210	1072	713655606	1159	713723063	871	713880086	825
713440663	1130	713504230	1074	713660700	932	713723064	871	713880092	827
713440664	1130	713504232	1074	713660705	932	713726040	1168	713880093	827
713440665	1130	713539001	324	713661111	935	713726060	1168	713880094	827
713440700	1097	713570015	1118	713661112	935	713726080	1168	713880098	827
713440732	1097	713571941	1118	713661113	935	713726120	1168	713880099	827
713440733	1097	713601762	1134	713661114	935	713770102	814	713880100	827
713440734	1097	713601763	1134	713661115	935	713770125	814	713880103	829
713440912	1117	713608011	1135	713661116	935	713770126	815	713880104	829
713441008	1122	713608012	1135	713661117	935	713770127	814	713880105	829
713441108	1122	713612308	1160	713661118	935	713770512	839	713880106	829
713441109	1091	713612310	1160	713661121	935	713770610	812	713880107	829
713441122	1091	713612314	1160	713661122	935	713771050	812	713880108	829
713441164	1126	713620251	880	713661123	935	713772992	839	713880109	829
713441305	1097	713620253	880	713661124	935	713772993	839	713880110	829
713441306	1097	713620275	880	713661125	935	713776111	803	713880111	829
713441310	1119	713620303	882	713661126	935	713776165	803	713880112	829
713441315	1119	713620352	885	713661127	935	713779200	813	713880113	829
713441410	1119	713621315	883	713661128	935	713780011	823	713880114	829

Order nr.	Pag.	Order nr.	Pag.	Order nr.	Pag.	Order nr.	Pag.	Order nr.	Pag.
713880115	829	715163512	687	715903260	676	715931023	681	721391922	181
713880116	829	715163515	687	715903300	677	715931030	679	721392224	181
713900030	488	715163606	687	715903301	677	715931050	679	721392430	181
713921001	870	715163706	687	715903315	693	715931052	680	721392730	181
713921221	867	715163712	687	715904150	669	715931056	680	721393236	181
713921226	867	715163715	687	715904250	669	715931060	681	721401700	181
713921227	867	715164310	687	715905200	675	715931101	681	721401900	181
713922000	869	715164315	687	715905250	675	715931102	681	721402200	181
713922003	869	715164320	687	715905305	675	715960501	701	721402400	181
713922004	869	715164325	687	715905600	683	715960700	701	721402700	181
713922011	869	715165310	687	715910258	695	715960703	701	721402900	181
713922012	869	715165311	687	715910259	695	715970055	701	721403000	181
713922013	869	715165315	687	715910810	685	715970070	701	721403200	181
713922014	869	715165316	687	715910812	685	715970155	701	721403600	181
713940010	822	715165320	687	715910813	685	715970170	701	721404100	181
713940112	831	715165321	687	715910814	685	715981105	700	722011000	183
713940113	831	715165325	687	715911001	1172	715981117	700	722011500	183
713951407	926	715165326	687	715911006	1168	715991105	700	722012000	183
713951611	928	715165328	687	715911008	1168	716150001	369	722013000	183
713952012	930	715166310	687	715911010	1168	716150230	374	722174000	227
713990016	875	715166315	687	715911012	1168	716150256	367	722175000	227
713992000	874	715166320	687	715911015	1168	716150262	369	722176000	227
71421002	1134	715166325	687	715911206	1170	716152506	366	722184000	227
715001410	698	715166326	687	715911208	1170	716154100	370	722184010	227
715100004	674	715260305	690	715911210	1170	716154200	370	722186000	227
715101411	495	715260305	691	715911212	1170	716159100	368	722186010	227
715101911	495	715260306	690	715911218	1170	716170001	407	722310033	772
715102019	495	715260306	691	715911506	1172	716170003	407	722310034	772
715102070	496	715262518	693	715911508	1172	716170006	407	722310035	772
715102102	496	715262524	693	715911510	1172	716170010	407	722310036	772
715102151	496	715262542	693	715911512	1172	716170103	404	722310037	772
715102152	496	715262581	693	715911515	1172	716170105	404	722313490	724
715111000	705	715263128	693	715911628	688	716170110	404	722313491	728
715114501	705	715263148	693	715911628	689	716170405	433	722313500	724
715121051	702	715263160	693	715911660	688	716170410	433	722313501	728
715121052	703	715326617	678	715911660	689	716190003	375	722313502	728
715121053	703	715333682	678	715911661	688	716190008	375	722313503	730
715121054	703	715336718	678	715911661	689	716190010	375	722313504	728
715121501	702	715701305	691	715912256	692	716190020	375	722313505	726
715121502	702	715702305	690	715912257	692	716190050	374	722313506	728
715122005	703	715900003	932	715912501	1172	716190100	374	722313507	728
715122006	703	715900004	706	715912506	1172	716190250	374	722313508	731
715122007	703	715900004	932	715912508	1172	716190900	402	722313509	730
715122008	703	715900005	706	715912510	1172	716191000	374	722313510	726
715122054	703	715900005	932	715912512	1172	716191030	373	722313511	728
715122055	703	715900006	707	715912515	1172	716191060	373	722313530	727
715122056	703	715900007	707	715913251	694	716191120	373	722313540	727
715122401	702	715900008	707	715913260	676	716192060	372	722313541	729
715122403	702	715900009	707	715913311	677	716192120	372	722313545	725
715122554	703	715900010	707	715914250	669	716195020	372	722313546	729
715123054	703	715900012	707	715916002	683	716196015	373	722313548	729
715123055	703	715900012	933	715916005	683	716196050	373	722313549	729
715123056	703	715900020	706	715917510	1170	716197150	373	722313557	624
715123303	702	715900022	706	715917512	1170	716199800	407	722313559	624
715124003	702	715900023	706	715917515	1170	716201500	372	722314070	720
715125054	703	715900024	706	715917518	1170	716201600	373	722314125	720
715125055	703	715900025	706	715917522	1170	716201705	433	722314130	721
715125056	703	715900251	684	715917560	1170	716202001	375	722314135	721
715125403	703	715900255	695	715917580	1170	716202005	375	722314140	722
715127003	704	715900256	695	715918510	1171	716205000	717	722314142	722
715127004	704	715900301	669	715918512	1171	716351025	242	722314145	722
715127005	704	715900315	696	715918515	1171	716351050	242	722314147	722
715141212	703	715900317	697	715918518	1171	716351100	242	722314175	720
715142443	703	715900351	684	715918522	1171	716700031	708	722314215	720
715142444	703	715900410	684	715918560	1171	716706030	709	722315070	718
715153501	685	715900471	684	715918580	1171	716706040	709	722315125	719
715154301	685	715900504	688	715918710	1167	716706060	710	722316062	723
715154303	685	715900505	689	715918712	1167	716706080	710	722316064	723
715155303	685	715900790	671	715918715	1167	717001120	455	722316150	723
715155313	686	715900791	671	715918718	1167	717001140	455	722316153	723
715156303	686	715900850	672	715918722	1167	717001145	455	722316200	717
715162506	687	715900851	672	715918760	1167	717001270	456	722316216	717
715162512	687	715901405	674	715918780	1167	717002130	456	722316227	717
715163106	687	715901500	673	715920450	679	717002150	456	722316240	716
715163112	687	715902000	699	715920900	680	717003110	454	722316300	722
715163115	687	715902200	670	715921100	680	717003120	454	722316345	714
715163206	687	715902251	668	715921200	681	719000410	1077	722316350	714
715163216	687	715902255	692	715931011	679	719000420	1076	722316352	714
715163226	687	715903251	694	715931020	681	721391013	181	722316360	715
715163506	687	715903253	694	715931021	681	721391719	181	722316363	716

NUMERIEKE INDEX

Order nr.	Pag.	Order nr.	Pag.	Order nr.	Pag.	Order nr.	Pag.	Order nr.	Pag.
722316365	715	724576512	478	72673403	169	73190209	210	741802501	618
722316366	715	724576514	479	72673502	169	73190258	210	74190026	220
722316367	715	724576519	474	72673601	169	73190274	210	74190059	220
722316385	716	724576521	474	72673700	169	73190282	210	74190075	219
722316386	716	724576522	479	72673809	169	73190308	210	74190083	219
722316387	716	724576523	479	72673825	169	73190407	210	74190109	220
722316390	716	724576524	479	72673833	169	73191009	213	74190307	220
722410001	772	724576525	479	72673841	169	73191108	213	742001105	1150
724302020	423	724576526	479	72673858	169	73191207	213	742001106	1150
724551010	425	724576527	494	72673866	169	73191256	213	742001107	1150
724552020	425	724576528	494	72673874	169	73191306	213	742001108	1150
724557575	242	724581040	266	72673882	169	73191405	213	742001110	1150
724561001	420	724581050	266	72673908	169	73191504	213	742001605	1150
724561003	421	724581070	266	72674005	169	73191603	213	742001606	1150
724561004	420	724581075	266	72674104	169	73191702	213	742001608	1150
724561006	420	724581100	266	72674203	169	73191801	213	742001610	1150
724561009	427	724581110	266	72674302	169	73191900	213	742001612	1150
724561010	427	724581120	266	72674401	169	73240103	319	742001614	1150
724561011	427	724581130	266	72674500	169	73250102	316	742001616	1150
724561012	427	724581140	266	727814800	234	73530107	161	742002106	1150
724561013	427	724581180	266	727814810	234	73720500	129	742002108	1150
724561014	427	724581180	1171	727815010	233	73721003	129	742002110	1150
724561028	312	724581185	266	727816400	234	73721102	129	742002112	1150
724561030	426	724581185	1171	727817020	232	73721201	129	742002114	1150
724561031	426	724581190	266	727817100	233	73721300	129	742002116	1150
724561041	421	724581190	1171	727819010	232	73721409	129	742002118	1150
724562001	443	724581195	266	727819090	233	73722050	129	742006040	1150
724562003	443	724581195	1171	727819500	233	73722159	129	742006050	1150
724563001	422	724581230	266	727819700	234	73722209	129	742006060	1150
724563002	422	724581310	266	728091085	64	73722308	129	742006080	1150
724563003	422	724603000	425	728540090	207	73722407	129	742006090	1150
724563004	422	724605000	425	728540100	207	737551500	603	742061000	1150
724563005	422	725473060	424	728541001	207	737553000	603	742061200	1150
724563006	422	725473061	424	728541017	207	73860108	131	742061400	1150
724563008	423	72570104	199	728600530	271	73860207	131	742061505	1150
724563009	423	72660103	142	72920200	179	73860256	131	742061506	1150
724563010	423	72660202	142	72920309	179	73860306	131	742061600	1150
724563011	423	72670052	169	72920358	179	73860355	131	742061800	1150
724563014	423	72670102	169	72920408	179	73860405	131	742062000	1150
724563016	423	72670201	169	72920507	179	73860454	131	742062008	1150
724563022	423	72670300	169	72920606	179	73860504	131	742062010	1150
724570010	426	72670409	169	72920705	179	73860553	131	742062012	1150
724570011	426	72670508	169	72921000	179	73860603	131	742064006	1150
724571010	426	72670607	169	72921109	179	73860652	131	742064008	1150
724571110	423	72670706	169	72921208	179	73860702	131	742064010	1150
724573035	425	72670805	169	73000101	106	73860801	131	742064012	1150
724573040	425	72670904	169	73000101	179	73980104	130	742069040	1150
724573055	426	72671001	169	73090102	163	73980203	130	742070100	1141
724573330	424	72671100	169	73100109	164	73980252	130	742070150	1141
724574040	423	72671209	169	731010002	807	73980302	130	742070200	1141
724574050	424	72671308	169	731010004	806	73980401	130	742070250	1141
724574180	424	72671407	169	731010005	806	73981003	130	742070300	1141
724575050	425	72671506	169	731010006	806	73981052	130	742070350	1141
724575220	425	72671605	169	731013000	806	73982001	130	742070400	1141
724576020	477	72671704	169	731015000	806	74031006	337	742070450	1141
724576040	477	72671803	169	731024080	807	74110057	131	742070500	1141
724576050	474	72671902	169	731035022	807	74110073	131	742070550	1141
724576080	477	72672009	169	731035026	807	74110107	131	742070600	1141
724576085	478	72672108	169	731045010	807	74110206	131	742070650	1141
724576090	478	72672207	169	731051001	839	74150103	224	742070700	1141
724576200	475	72672306	169	731051064	839	74160011	257	742070750	1141
724576400	475	72672405	169	731051066	839	74160029	257	742070800	1141
724576405	475	72672504	169	731051068	839	74160037	257	742070850	1141
724576490	475	72672603	169	731051070	839	74160052	257	742070900	1141
724576491	474	72672652	169	731051072	839	74160102	257	742070950	1141
724576492	474	72672686	169	731051074	839	74160201	257	742071000	1141
724576493	474	72672702	169	731051076	839	74160300	256	742071050	1141
724576494	474	72672751	169	731051078	839	74160409	256	742071100	1141
724576495	474	72672801	169	731051080	839	74170051	221	742071150	1141
724576496	474	72672850	169	731051082	839	74170101	221	742071200	1141
724576497	474	72672900	169	73120107	316	741711001	619	742071250	1141
724576500	474	72672926	169	73160103	163	741711002	619	742071300	1141
724576502	476	72672942	169	73170102	130	741761001	618	742080100	1141
724576502	476	72672959	169	73190035	210	741761714	618	742080125	1141
724576505	476	72672967	169	73190050	210	741761720	618	742080150	1141
724576506	477	72672983	169	73190076	210	741771400	618	742080175	1141
724576508	475	72673007	169	73190100	112	741772000	618	742080200	1141
724576509	476	72673106	169	73190100	212	741791800	618	742080225	1141
724576510	478	72673205	169	73190175	210	741792500	618	742080250	1141
724576511	479	72673304	169	73190191	210	741801801	618	742080275	1141

Order nr.	Pag.	Order nr.	Pag.	Order nr.	Pag.	Order nr.	Pag.	Order nr.	Pag.
742080300	1141	742101130	1139	742121085	1138	742170325	1139	74310806	137
742080325	1141	742101150	1139	742121086	1138	742170350	1139	74310905	137
742080350	1141	74210147	218	742121087	1138	742170375	1139	74311002	137
742080375	1141	74210154	218	742121088	1138	742170400	1139	74311101	137
742080400	1141	74210170	218	742121089	1138	742170425	1139	74311200	137
742080425	1141	74210196	218	742121090	1138	742170450	1139	74311309	137
742080450	1141	74210204	218	742121091	1138	742170475	1139	74311408	137
742080475	1141	742110006	1151	742121092	1138	742170500	1139	74311507	137
742080500	1141	742120019	1136	742121093	1138	742170525	1139	74311556	137
742080525	1141	742120025	1136	742121094	1138	742170550	1139	74311655	137
742080550	1141	742121005	1138	742121095	1138	742170575	1139	74311754	137
742080575	1141	742121010	1138	742121096	1138	742170600	1139	74311804	137
742080600	1141	742121011	1138	742121097	1138	742170650	1139	74311853	137
742080650	1141	742121012	1138	742121098	1138	742170700	1139	74312109	137
742080700	1141	742121013	1138	742121099	1138	742170750	1139	74312208	137
742080750	1141	742121014	1138	742121100	1138	742170800	1139	74312257	137
742080800	1141	742121015	1138	742121105	1138	742170850	1139	74312307	137
742080850	1141	742121016	1138	742121110	1138	742170900	1139	74313008	137
742080900	1141	742121017	1138	742121115	1138	742171000	1139	74313107	137
742080950	1141	742121018	1138	742121120	1138	742180200	1140	74313206	137
742081000	1141	742121019	1138	742121125	1138	742180250	1140	74313305	137
742081050	1141	742121020	1138	742121130	1138	742180300	1140	74313404	137
742081100	1141	742121021	1138	742121135	1138	742180325	1140	74313503	137
742081150	1141	742121022	1138	742121140	1138	742180350	1140	74313602	137
742081200	1141	742121023	1138	742121145	1138	742180375	1140	74313701	137
742081250	1141	742121024	1138	742121150	1138	742180400	1140	74313800	137
742081300	1141	742121025	1138	742121155	1138	742180425	1140	74313909	137
742090100	1140	742121026	1138	742121160	1138	742180450	1140	74314006	137
742090150	1140	742121027	1138	742121175	1138	742180475	1140	74314105	137
742090200	1140	742121028	1138	742121225	1138	742180500	1140	74314204	137
742090250	1140	742121029	1138	742121275	1138	742180525	1140	74314303	137
742090300	1140	742121030	1138	742121325	1138	742180550	1140	74314402	137
742090350	1140	742121031	1138	742121375	1138	742180575	1140	74314501	137
742090400	1140	742121032	1138	742121425	1138	742180600	1140	74314600	137
742090450	1140	742121033	1138	742121475	1138	742180650	1140	74314709	137
742090500	1140	742121034	1138	742121525	1138	742180700	1140	74314808	137
742090550	1140	742121035	1138	742121575	1138	742180750	1140	74314907	137
742090600	1140	742121036	1138	742121625	1138	742180800	1140	74315003	137
742090650	1140	742121038	1138	742121700	1138	742180850	1140	74315102	137
742090700	1140	742121039	1138	742121725	1138	742180900	1140	74315201	137
742090750	1140	742121040	1138	742121775	1138	742180950	1140	74315508	137
742090800	1140	742121041	1138	742121825	1138	742181000	1140	74315607	137
742090850	1140	742121042	1138	742121875	1138	742181050	1140	74315706	137
742090900	1140	742121043	1138	742121925	1138	742181100	1140	74315805	137
742090950	1140	742121044	1138	742121975	1138	742181150	1140	74316001	137
742091000	1140	742121045	1138	742122025	1138	742181200	1140	74316100	137
742091100	1140	742121046	1138	742122075	1138	742181250	1140	74316209	137
742091200	1140	742121047	1138	742122125	1138	742181300	1140	74316407	137
742091300	1140	742121048	1138	742122175	1138	74230038	220	74316506	137
742101005	1139	742121049	1138	742122225	1138	74230053	220	74316605	137
742101010	1139	742121050	1138	742122275	1138	74230103	220	74316704	137
742101015	1139	742121051	1138	742123125	1138	74230152	220	74316803	137
742101020	1139	742121052	1138	742131100	1142	74230178	220	74316902	137
742101025	1139	742121053	1138	742131105	1142	74230202	220	74317009	137
742101026	1139	742121054	1138	742131150	1142	74250036	225	74317108	137
742101030	1139	742121055	1138	742131200	1142	74250044	225	74350109	252
742101033	1139	742121056	1138	742131250	1142	74250051	225	74350208	252
742101035	1139	742121057	1138	742131300	1142	74250101	225	744591020	1168
742101040	1139	742121058	1138	742131350	1142	74250200	225	744591030	1168
742101041	1139	742121059	1138	742131400	1142	74270059	225	744591204	1169
742101042	1139	742121060	1138	742131450	1142	74270109	225	744591206	1169
742101045	1139	742121061	1138	742131500	1142	74270208	225	744591212	1169
74210105	218	742121062	1138	742131550	1142	74290107	128	745600812	349
742101050	1139	742121065	1138	742131600	1142	74290206	128	745601017	349
742101055	1139	742121067	1138	742131650	1142	74290305	128	745601220	349
742101060	1139	742121068	1138	742131700	1142	74291006	129	745601625	349
742101065	1139	742121069	1138	742131750	1142	74291105	129	745602032	349
742101068	1139	742121070	1138	742131800	1142	74291204	129	745602540	349
742101070	1139	742121071	1138	742131850	1142	74310038	137	745603250	349
742101075	1139	742121072	1138	742131900	1142	74310061	137	745604060	349
742101080	1139	742121073	1138	742131950	1142	74310103	137	745605070	349
742101085	1139	742121074	1138	742132000	1142	74310202	137	745651100	351
742101090	1139	742121075	1138	742140401	1110	74310301	137	745651101	351
742101095	1139	742121076	1138	742140501	1111	74310400	137	745651102	351
742101100	1139	742121077	1138	742161700	1137	74310509	137	745660103	350
742101102	1139	742121079	1138	742161900	1136	74310608	137	745660112	350
742101105	1139	742121080	1138	742162500	1136	74310707	137	745660130	350
742101110	1139	742121081	1138	742170200	1139	743107150	863	745660139	350
742101120	1139	742121082	1138	742170250	1139	743107153	863	745660148	350
742101125	1139	742121084	1138	742170300	1139	743107207	863	745660161	350

NUMERIEKE INDEX

Order nr.	Pag.	Order nr.	Pag.	Order nr.	Pag.	Order nr.	Pag.	Order nr.	Pag.
745660174	350	745702314	350	745747095	349	747809001	235	748260016	1154
745661000	346	745702415	350	745747101	351	747809320	235	748260017	1154
745661001	346	745702516	350	745747102	351	747809408	235	748260019	1154
745661010	351	745702617	350	745747103	351	747809410	235	748260020	1154
745661030	351	745702718	350	745747104	351	747809412	235	748260021	1154
745661430	346	745702819	350	745747107	351	747809481	235	748260022	1154
745661432	346	745702920	350	745800010	469	747809482	235	748260024	1154
745661433	346	745703021	350	745800020	469	748104040	1111	748260025	1154
745661650	346	745703122	350	745800025	469	748191809	1152	748260027	1154
745661720	350	745703324	350	745800240	462	748191910	1152	748260029	1154
745661750	347	745703425	350	745800450	460	748192516	1152	748260030	1154
745662325	350	745721001	348	745800460	460	748231001	1143	748260032	1154
745662931	350	745721102	348	745800520	468	748231102	1143	748260033	1154
745663639	350	745721203	348	745800540	468	748231203	1143	748260035	1154
745664043	350	745721304	348	745800550	461	748231304	1143	748260037	1154
745664447	350	745721405	348	745800560	461	748231405	1143	748260038	1154
745664851	350	745721506	348	745800610	461	748231506	1143	748260040	1154
745665255	350	745721607	348	745800630	461	748231607	1143	748260041	1154
745665659	350	745721708	348	745800640	461	748231708	1143	748260043	1154
745666467	350	745721809	348	745800662	463	748231809	1143	748260044	1154
745666873	350	745721910	348	745800663	464	748231910	1143	748260046	1154
745667479	350	745722011	348	745800664	464	748232011	1143	748260048	1154
745668085	350	745722112	348	745800665	463	748232112	1143	748260051	1154
745669297	350	745722213	348	745800665	464	748232213	1143	748260052	1154
745671304	348	745722314	348	745800666	463	748232314	1143	748260054	1154
745671405	348	745722415	348	745800666	464	748232415	1143	748260057	1154
745671506	348	745722516	348	745800701	464	748232516	1143	748260059	1154
745671607	348	745722617	348	745800702	464	748232617	1143	748260060	1154
745671708	348	745723021	348	745800703	464	748232718	1143	748260064	1154
745671809	348	745723223	348	745800704	464	748232819	1143	748260065	1154
745671910	348	745723526	348	745800705	464	748232920	1143	748260067	1154
745672011	348	745731001	347	745800706	464	748233021	1143	748260068	1154
745672112	348	745731102	347	745800707	464	748233122	1143	748260070	1154
745672213	348	745731203	347	745800708	464	748233223	1143	748260073	1154
745672314	348	745731304	347	745800709	464	748233324	1143	748260076	1154
745672415	348	745731405	347	745800710	464	748233425	1143	748260079	1154
745672516	348	745731506	347	745800711	464	748233526	1143	748260083	1154
745672617	348	745731607	347	745800712	464	748233627	1143	748260086	1154
745672718	348	745731708	347	745800713	464	748233728	1143	748260089	1154
745672819	348	745731809	347	745800714	464	748233829	1143	748260092	1154
745672920	348	745731910	347	745800715	464	748233930	1143	748260095	1154
745673021	348	745732011	347	745800716	464	748234031	1143	748260098	1154
745673223	348	745732112	347	745800717	464	748234132	1143	748260102	1154
745681304	347	745732213	347	745800718	465	748234233	1143	748260105	1154
745681507	347	745732314	347	745800719	465	748234334	1143	748260108	1154
745681607	347	745732415	347	745800720	465	748234435	1143	748260111	1154
745681809	347	745732516	347	745800721	464	748234536	1143	748260114	1154
745681910	347	745732617	347	745800722	464	748234637	1143	748260121	1154
745682011	347	745732718	347	745800723	464	748234738	1143	748260127	1154
745682213	347	745732819	347	745800724	465	748234839	1143	748260140	1154
745682314	347	745732920	347	745800725	465	748234940	1143	748260152	1154
745682415	347	745733021	347	745800726	465	748235041	1143	748261430	1154
745682516	347	745733122	347	745800727	395	748235142	1143	748261964	1153
745682617	347	745733223	347	747111012	619	748235243	1143	748263152	1154
745682718	347	745733324	347	747111014	619	748235344	1143	748264152	1154
745682819	347	745733425	347	747111016	619	748235445	1143	748269200	1154
745682920	347	745733526	347	747111026	619	748235546	1143	748269201	1154
745683021	347	745740100	349	747111031	619	748235647	1143	748279015	1144
745683122	347	745740120	349	747141015	1113	748235748	1143	748279063	1144
745683223	347	745740140	349	747141217	1113	748235849	1143	748279073	1144
745691001	349	745740160	349	747141420	1113	748235950	1143	748279083	1144
745691102	349	745740180	349	747141620	1113	748236051	1143	748279094	1144
745691203	349	745740200	349	747141825	1113	748236152	1143	748279104	1144
745691304	349	745740220	349	747143050	1113	748236253	1143	748279124	1144
745691405	349	745740240	349	747144070	1113	748236455	1143	748279165	1144
745691506	349	745740260	349	747145080	1113	748236657	1143	748279205	1144
745691607	349	745740280	349	747146100	1113	748236859	1143	748280101	1145
745691708	349	745740300	349	747148125	1113	748240000	1143	748280102	1145
745691809	349	745740320	349	747150310	1110	748240100	1143	748280103	1145
745691910	349	745740340	349	747801004	235	748240160	1143	748280104	1145
745701304	350	745740360	349	747801005	235	748240200	1143	748280105	1145
745701405	350	745740380	349	747801006	235	748240250	1143	748280106	1145
745701506	350	745740400	349	747801008	235	748240315	1143	748280109	1145
745701607	350	745740480	349	747801010	235	748240400	1143	748280124	1145
745701708	350	745740500	349	747802040	235	748240500	1143	748297106	1151
745701809	350	745742035	349	747802050	235	748240630	1143	748297107	1151
745701910	350	745742540	349	747802060	235	748255080	1144	748297108	1151
745702011	350	745743050	349	747802080	235	748255081	1144	748297110	1151
745702112	350	745744070	349	747804001	235	748255082	1144	748300115	1116
745702213	350	745746080	349	747805001	235	748255083	1144	748300125	1116

Order nr.	Pag.	Order nr.	Pag.	Order nr.	Pag.	Order nr.	Pag.	Order nr.	Pag.
748300201	1116	748421212	1115	749611042	1088	754725001	439	754752025	380
748300508	1116	748421213	1115	749611044	1088	754725002	439	754752026	380
748300601	1116	748421401	1116	749611053	1088	754725003	439	754752027	380
748301125	1116	748421402	1116	749611054	1088	754725004	439	754752028	380
748310650	1151	748421411	1116	749642018	1087	754725006	439	754752029	380
748310800	1151	748421412	1116	749643018	1087	754725007	439	754752030	380
748310810	1151	748423011	1115	749644018	1087	754725008	439	754752031	380
748311650	1151	748423814	1115	749661910	1086	754725008	442	754752220	428
748311800	1151	748431051	1114	751001500	482	754725009	439	754752221	428
748311810	1151	748431081	1114	751001501	482	754725009	442	754752222	438
748320010	1145	748431091	1114	751001503	482	754725011	439	754752225	439
748320020	1145	748431101	1114	751001504	483	754725011	442	754752260	429
748320030	1145	748431121	1114	751001505	483	754750020	450	754752261	429
748320040	1145	748431161	1114	751001506	482	754750022	430	754752262	428
748320070	1145	748431191	1114	751001507	483	754750025	447	754752266	428
748401100	1112	748431201	1114	751002000	482	754750027	452	754752270	429
748401200	1112	748431221	1114	751002001	482	754750041	452	754752286	430
748411075	1113	748431231	1114	751002004	482	754750059	452	754752500	377
748411102	1113	748431251	1114	751002008	483	754750060	452	754752510	385
748411141	1113	748431261	1114	751002009	483	754750064	450	754752511	385
748411203	1113	748431271	1114	751002017	483	754750066	453	754752512	385
748411304	1113	748431275	1114	751002018	483	754750069	444	754752513	385
748411405	1113	748431281	1114	751002019	483	754750070	444	754752514	385
748411506	1113	748431300	1115	751002020	483	754750071	444	754752515	385
748411510	1113	748431301	1114	751002021	482	754750072	444	754752516	396
748411512	1113	748431302	1115	751002022	483	754750073	445	754752517	396
748411513	1113	748431303	1115	751005080	493	754750076	445	754752518	396
748411514	1113	748431304	1115	751501102	488	754750077	445	754752519	396
748411520	1113	748431305	1115	751501203	491	754750116	446	754752520	396
748411534	1113	748431306	1115	751501210	491	754750500	431	754752521	396
748411607	1113	748431311	1114	751501304	491	754751000	430	754752522	396
748411708	1113	748431320	1114	751503000	275	754751001	246	754752523	396
748411710	1113	748431321	1114	751600010	488	754751103	432	754752524	396
748411712	1113	748431331	1114	751601000	488	754751105	432	754752525	396
748411714	1113	748431341	1114	751607000	488	754751108	432	754752526	396
748411715	1113	748431351	1114	751981001	408	754751110	432	754752527	396
748411716	1113	748431361	1114	751985181	408	754751112	432	754752528	396
748411718	1113	748431381	1114	751985182	408	754751120	432	754752529	396
748411720	1113	748431391	1114	751985191	408	754751131	432	754752530	396
748411734	1113	748431401	1114	751985192	408	754751210	447	754752531	396
748411738	1113	748431411	1114	751985200	408	754751212	419	754752532	394
748411809	1113	748431431	1114	751985201	408	754751225	419	754752533	394
748411910	1113	748431441	1114	751985202	408	754751227	419	754752534	394
748412011	1113	748431451	1114	751985204	408	754751300	432	754752535	394
748412112	1113	748431471	1114	751987010	409	754751314	438	754752536	396
748412213	1113	748431481	1114	751987013	408	754751340	438	754752537	396
748412314	1113	748431491	1114	751987023	409	754751350	438	754752538	396
748412415	1113	748431511	1114	751987025	408	754751410	448	754752539	396
748412516	1113	748431521	1114	751987026	408	754751442	448	754752540	397
748412617	1113	748431531	1114	751987028	409	754751443	453	754752541	397
748412718	1113	748431541	1114	751987029	409	754751451	452	754752542	397
748412819	1113	748431561	1114	751987030	409	754751451	453	754752543	397
748412920	1113	748431581	1114	751987032	408	754751452	452	754752544	397
748413021	1113	748431591	1114	751988120	275	754751453	452	754752545	397
748413223	1113	748431601	1114	751989052	458	754751459	452	754752546	397
748413324	1113	748431611	1114	751989053	458	754751467	452	754752547	397
748413425	1113	748431621	1114	751989055	458	754751471	452	754752548	397
748413526	1113	748431631	1114	751989057	459	754751500	433	754752549	397
748413627	1113	748440305	1113	751989058	459	754751502	403	754752550	397
748413728	1113	748440407	1113	751989059	459	754751517	452	754752551	397
748413829	1113	748440508	1113	751989060	459	754751522	452	754752552	397
748413930	1113	748440610	1113	751989061	459	754751531	452	754752553	397
748414031	1113	748440710	1113	751989062	459	754751536	452	754752554	397
748414132	1113	748441015	1113	751989063	459	754751546	452	754752555	397
748414233	1113	748441115	1113	75240101	140	754751561	439	754752556	397
748414334	1113	748442175	1113	75240200	140	754751579	449	754752557	397
748414435	1113	748448125	1113	754720001	440	754751581	764	754752558	397
748414536	1113	748449125	1113	754720002	441	754751583	764	754752559	397
748420100	1115	748529000	264	754720003	441	754751585	764	754752560	397
748420101	1115	748529000	1116	754720004	442	754751810	377	754752561	397
748420102	1115	749202000	1120	754720005	440	754751910	378	754752562	397
748420103	1115	749551102	1086	754720006	436	754751990	449	754752563	397
748420165	1115	749601021	1088	754720007	436	754752000	378	754752564	397
748420205	1115	749601031	1088	754720008	437	754752010	378	754752610	381
748420207	1115	749601052	1088	754720009	419	754752019	378	754752611	381
748420259	1115	749601053	1088	754720010	419	754752020	378	754752612	381
748421112	1115	749601054	1088	754720012	442	754752021	380	754752613	381
748421203	1115	749611012	1088	754720013	442	754752022	380	754752614	381
748421204	1115	749611021	1088	754720014	442	754752023	380	754752615	381
748421211	1115	749611033	1088	754720021	443	754752024	380	754752616	381

NUMERIEKE INDEX

Order nr.	Pag.	Order nr.	Pag.	Order nr.	Pag.	Order nr.	Pag.	Order nr.	Pag.
754752617	381	754752756	388	754752949	396	756200707	414	757571212	409
754752618	381	754752757	388	754752950	396	756200720	414	757572525	409
754752619	381	754752758	388	754752951	396	756200725	415	757575050	409
754752620	381	754752759	388	754752952	396	756200730	416	757575151	410
754752621	381	754752760	388	754752953	396	756200735	415	758120195	497
754752622	381	754752762	388	754752954	396	756200745	414	758120265	497
754752623	381	754752763	388	754752955	396	756200808	418	758120445	498
754752624	381	754752764	388	754752956	379	756202520	417	758120446	499
754752625	381	754752765	388	754752957	379	756203001	413	758120700	498
754752626	381	754752766	388	754752958	379	756203002	413	758120905	499
754752627	381	754752767	388	754752959	379	757001010	247	758121100	497
754752628	381	754752769	388	754752960	379	757001111	247	758121550	497
754752629	381	754752771	388	754752961	379	757001212	247	758121670	497
754752630	381	754752773	388	754752962	379	757001313	247	758121800	497
754752631	381	754752774	388	754752963	379	757001414	247	758136210	270
754752632	381	754752775	388	754752964	379	757001515	247	758136330	270
754752633	381	754752776	388	754752965	379	757001616	247	758136430	270
754752658	382	754752778	388	754752966	379	757001717	247	758136515	270
754752659	382	754752779	388	754752967	379	757001818	247	758136518	270
754752660	382	754752780	388	754752968	379	757001919	247	758136522	270
754752661	382	754752781	388	754752969	379	757002020	247	758136526	271
754752662	382	754752782	389	754752970	379	757002110	247	758136527	271
754752663	382	754752783	389	754752975	393	757002112	247	758136528	271
754752664	382	754752785	389	754752976	393	757002211	247	758136529	271
754752665	382	754752787	389	754752977	393	757002222	247	758136530	271
754752666	382	754752789	389	754752978	393	757002323	247	758136531	270
754752667	382	754752790	389	754752979	393	757002424	247	758136532	270
754752668	382	754752791	389	754752980	393	757002525	247	758136533	270
754752669	382	754752792	389	754752981	393	757002626	247	758136534	270
754752670	382	754752794	389	754752982	393	757002727	247	758136535	270
754752671	382	754752795	389	754752983	393	757002828	247	758136575	460
754752672	382	754752796	389	754752984	393	757003030	247	758136596	462
754752673	382	754752797	389	754752990	395	757004040	247	758136597	462
754752674	382	754752798	390	754752991	395	757005050	247	758136598	462
754752675	382	754752799	390	754752992	395	757006060	247	758136610	375
754752676	382	754752801	390	754752993	395	757007070	247	758136637	470
754752677	382	754752802	390	754752994	395	757008080	247	758136639	470
754752678	382	754752804	390	754753000	429	757009090	247	758136640	470
754752679	382	754752805	390	754753030	419	757160505	799	758136651	470
754752680	382	754752806	391	754753080	437	757161010	799	758136652	470
754752681	382	754752807	391	754753100	435	757161614	800	758136656	470
754752706	383	754752809	391	754753115	437	757161616	800	758136657	470
754752707	383	754752810	391	754753390	439	757161621	801	758136658	470
754752708	383	754752811	391	754753995	439	757161623	801	758136692	473
754752709	383	754752812	391	754755200	795	757161624	801	758136696	473
754752710	383	754752813	391	754756060	419	757161640	800	758136709	472
754752711	383	754752814	391	754756100	434	757170075	796	758136710	472
754752718	384	754752816	391	754756120	434	757170100	797	758136714	460
754752719	384	754752817	391	754756161	435	757170150	794	758136716	460
754752720	384	754752819	391	754756162	435	757170220	795	758136718	473
754752721	384	754752820	391	754756200	435	757170520	796	758136729	468
754752722	384	754752821	392	754756262	435	757172020	797	758136754	468
754752723	384	754752822	392	754758310	794	757173030	798	758136755	468
754752724	384	754752823	392	754758311	802	757175050	798	758136756	468
754752725	384	754752824	392	754773030	425	757176541	802	758136781	462
754752726	384	754752826	392	754800102	462	757176561	802	758136799	460
754752727	384	754752828	392	754800103	462	757176581	802	758136855	473
754752728	384	754752829	392	754800104	462	757176661	802	758136856	471
754752729	384	754752830	392	754800150	462	757491011	809	758136858	395
754752730	386	754752831	392	755000101	493	757491012	809	758136859	471
754752731	386	754752832	392	755002000	242	757491015	809	758136861	471
754752732	386	754752833	392	755002020	493	757491018	809	758136863	471
754752733	386	754752834	392	755002500	242	757491040	808	758136864	471
754752734	386	754752836	392	755003000	242	757491070	808	758136865	471
754752735	386	754752837	392	755003030	493	757491090	808	758136866	471
754752736	387	754752838	393	755004040	493	757491099	808	758136867	471
754752737	387	754752839	393	755005050	493	757501001	810	758136868	461
754752740	387	754752840	393	755009250	242	757501102	810	758136869	461
754752741	387	754752841	393	755009300	242	757501203	810	758136871	461
754752742	387	754752842	393	756000510	412	757501304	810	758136872	461
754752743	387	754752843	393	756001006	412	757501405	810	758136873	461
754752744	387	754752844	393	756002006	412	757501506	810	758136874	461
754752745	387	754752845	393	756183650	413	757501508	810	758136878	461
754752747	387	754752846	393	756200620	417	757502212	810	758136880	473
754752748	387	754752847	393	756200625	416	757502217	810	758136883	473
754752749	387	754752848	393	756200630	418	757570020	408	758136891	472
754752750	387	754752849	393	756200632	416	757570050	408	758136893	472
754752751	388	754752850	393	756200634	417	757571000	410	758136895	471
754752752	388	754752851	393	756200638	417	757571010	410	758136896	472
754752754	388	754752948	396	756200705	414	757571150	409	758136897	473

Order nr.	Pag.	Order nr.	Pag.	Order nr.	Pag.	Order nr.	Pag.	Order nr.	Pag.
758136898	471	758307989	401	761000106	579	761000225	584	761000346	560
758136899	472	758307992	401	761000107	579	761000226	583	761000347	560
758136901	473	758308000	402	761000108	579	761000227	582	761000348	560
758136906	467	758308047	402	761000109	579	761000229	584	761000349	560
758136907	467	758580020	405	761000110	579	761000230	583	761000350	560
758136909	467	758580040	405	761000111	579	761000231	584	761000351	560
758136917	460	758580140	405	761000112	574	761000232	583	761000352	528
758136918	460	758580160	405	761000113	574	761000233	582	761000353	528
758136926	471	758580161	405	761000114	579	761000235	582	761000354	528
758136944	463	758580162	405	761000116	568	761000237	584	761000355	528
758136946	463	758580163	405	761000118	568	761000238	583	761000356	528
758136950	463	758580164	405	761000120	568	761000239	582	761000357	528
758136952	463	758580165	405	761000122	568	761000241	584	761000358	528
758136958	463	758580166	405	761000124	568	761000242	583	761000359	528
758136959	463	758580167	405	761000126	592	761000243	584	761000360	528
758136961	463	758580168	405	761000127	592	761000244	583	761000361	528
758136962	463	758580169	405	761000128	592	761000245	582	761000362	528
758136965	463	758580250	403	761000129	592	761000247	582	761000363	528
758136966	463	758580525	404	761000130	592	761000249	584	761000364	528
758136968	463	758580750	404	761000131	592	761000250	583	761000365	560
758136969	463	758581025	404	761000132	592	761000251	582	761000366	560
758136970	469	758581060	404	761000133	592	761000253	584	761000367	560
758136971	469	758581500	404	761000134	592	761000254	583	761000368	560
758136972	469	758581525	404	761000135	592	761000255	584	761000369	560
758136973	469	758582025	404	761000136	592	761000256	583	761000370	560
758136974	469	758582060	404	761000137	592	761000287	586	761000374	560
758136975	469	758583000	404	761000138	592	761000288	586	761000375	560
758136976	469	758583030	404	761000139	592	761000289	586	761000376	560
758136977	469	758583200	405	761000142	592	761000290	586	761000377	560
758136978	469	758592020	403	761000143	592	761000291	586	761000378	560
758136979	469	758592525	403	761000144	592	761000293	503	761000379	560
758136980	469	758592527	407	761000145	592	761000294	503	761000380	532
758136986	463	758601032	405	761000146	592	761000295	503	761000381	532
758136987	463	758601032	432	761000147	592	761000297	503	761000382	532
758136988	463	758611001	407	761000148	592	761000299	560	761000383	532
758136989	468	758611010	407	761000149	592	761000300	560	761000384	532
758136990	468	758611012	406	761000150	592	761000301	560	761000385	532
758136991	468	758611030	407	761000151	592	761000302	560	761000386	532
758136992	468	758611250	406	761000152	592	761000303	560	761000387	532
758136993	468	758612040	406	761000153	592	761000304	560	761000388	532
758136994	466	758613060	406	761000154	592	761000305	561	761000389	532
758136995	466	758613070	406	761000155	592	761000306	561	761000390	532
758136996	466	758613080	406	761000156	592	761000307	561	761000391	532
758136997	466	758621001	412	761000157	592	761000308	561	761000392	532
758136998	466	758621240	366	761000160	592	761000309	560	761000393	532
758136999	466	758621250	364	761000161	592	761000310	560	761000394	532
758137000	467	758621255	364	761000162	592	761000311	560	761000395	532
758137001	466	758621400	412	761000163	592	761000312	560	761000396	532
758137002	466	758621500	366	761000164	592	761000313	560	761000397	532
758137003	467	758621600	413	761000165	592	761000314	560	761000398	532
758137004	466	758622612	365	761000166	592	761000316	560	761000399	532
758137005	466	758623000	366	761000167	592	761000317	560	761000400	532
758137006	467	758624151	365	761000168	592	761000318	560	761000401	532
758137007	467	758624250	364	761000169	592	761000319	560	761000402	532
758201228	398	758624255	364	761000170	592	761000320	560	761000403	532
758201230	398	758625610	365	761000171	592	761000321	560	761000404	532
758201666	402	758625612	365	761000172	592	761000322	528	761000405	532
758204402	400	758629901	366	761000173	592	761000323	528	761000406	532
758204403	400	758701000	369	761000174	592	761000324	528	761000407	532
758204502	400	758702551	367	761000175	592	761000325	528	761000408	532
758204503	400	758704000	247	761000195	582	761000326	528	761000409	532
758205011	402	758710001	368	761000197	582	761000327	528	761000410	532
758205012	402	758725050	370	761000199	584	761000328	528	761000411	532
758208500	399	758725060	371	761000200	583	761000329	528	761000412	532
758208501	402	761000067	556	761000201	582	761000330	528	761000413	532
758208600	399	761000068	556	761000203	584	761000331	528	761000414	532
758209671	402	761000069	556	761000204	583	761000332	528	761000415	532
758301508	402	761000070	556	761000205	584	761000333	528	761000416	560
758301512	402	761000094	579	761000206	583	761000334	528	761000417	560
758301513	402	761000095	579	761000207	582	761000335	528	761000418	560
758302314	402	761000096	579	761000209	582	761000336	528	761000419	560
758302315	402	761000097	579	761000211	584	761000337	528	761000420	560
758303223	402	761000098	579	761000212	583	761000338	528	761000421	560
758304811	402	761000099	579	761000213	582	761000339	528	761000423	536
758305617	402	761000100	579	761000215	584	761000340	528	761000424	536
758307956	401	761000101	579	761000216	583	761000341	528	761000425	536
758307959	401	761000102	579	761000217	584	761000342	528	761000426	536
758307970	401	761000103	579	761000218	583	761000343	528	761000427	536
758307973	401	761000104	579	761000219	582	761000344	528	761000428	536
758307981	402	761000105	579	761000222	582	761000345	561	761000429	536

NUMERIEKE INDEX

Order nr.	Pag.	Order nr.	Pag.	Order nr.	Pag.	Order nr.	Pag.	Order nr.	Pag.
761000430	536	761000601	562	761000752	532	761000895	555	761001060	580
761000431	536	761000602	562	761000753	532	761000896	555	761001061	580
761000432	536	761000603	562	761000754	563	761000897	555	761001062	580
761000433	536	761000604	544	761000755	563	761000898	555	761001063	580
761000434	536	761000605	544	761000757	536	761000900	555	761001065	575
761000435	536	761000606	544	761000758	536	761000901	555	761001066	575
761000436	536	761000607	544	761000759	536	761000902	555	761001067	575
761000437	536	761000608	544	761000760	536	761000903	555	761001068	575
761000438	536	761000609	544	761000761	536	761000904	555	761001069	575
761000439	536	761000610	544	761000762	536	761000905	555	761001070	575
761000440	536	761000611	544	761000763	536	761000914	586	761001071	575
761000441	536	761000612	544	761000764	536	761000915	502	761001072	575
761000442	536	761000613	544	761000765	536	761000916	502	761001073	576
761000443	536	761000614	544	761000773	564	761000917	502	761001074	576
761000444	536	761000615	544	761000774	564	761000918	586	761001075	576
761000445	536	761000616	544	761000775	564	761000919	586	761001076	577
761000446	536	761000617	544	761000776	564	761000936	565	761001077	576
761000447	536	761000618	544	761000777	564	761000937	565	761001078	577
761000448	536	761000619	544	761000778	564	761000941	565	761001079	576
761000449	536	761000620	544	761000779	564	761000942	565	761001080	576
761000450	536	761000621	544	761000780	564	761000944	552	761001081	577
761000451	536	761000622	544	761000782	564	761000945	552	761001085	577
761000452	536	761000623	544	761000783	564	761000946	552	761001086	577
761000453	536	761000624	544	761000784	544	761000947	552	761001087	577
761000454	536	761000625	544	761000785	544	761000948	552	761001088	577
761000455	536	761000626	544	761000786	544	761000949	552	761001089	577
761000456	536	761000627	544	761000787	544	761000950	552	761001090	576
761000457	536	761000628	544	761000788	544	761000951	552	761001097	576
761000458	536	761000629	544	761000789	544	761000952	552	761001098	576
761000481	561	761000630	544	761000790	544	761000953	565	761001106	566
761000482	561	761000631	562	761000791	544	761000954	565	761001107	578
761000483	561	761000632	562	761000792	544	761000956	565	761001108	581
761000550	562	761000633	562	761000793	564	761000957	565	761001109	566
761000551	562	761000634	562	761000794	564	761000961	565	761001110	578
761000552	562	761000636	548	761000796	548	761000962	565	761001111	566
761000553	562	761000637	548	761000797	548	761000964	552	761001112	578
761000554	562	761000638	548	761000798	548	761000965	552	761001113	566
761000555	562	761000639	548	761000799	548	761000966	552	761001114	578
761000556	562	761000640	548	761000800	548	761000967	552	761001115	566
761000557	562	761000641	548	761000801	548	761000968	552	761001116	578
761000559	562	761000642	548	761000802	548	761000969	552	761001142	591
761000560	562	761000643	548	761000803	548	761000970	552	761001143	591
761000561	562	761000644	548	761000804	548	761000971	552	761001144	591
761000562	562	761000645	548	761000817	504	761000972	552	761001145	591
761000563	540	761000646	548	761000828	504	761000973	565	761001146	591
761000564	540	761000647	548	761000856	505	761000974	565	761001147	591
761000565	540	761000648	548	761000857	506	761000998	597	761001148	588
761000566	540	761000649	548	761000858	506	761000999	598	761001149	588
761000567	540	761000650	548	761000859	506	761001000	597	761001150	588
761000568	540	761000651	548	761000860	506	761001001	598	761001154	590
761000569	540	761000652	548	761000861	506	761001002	597	761001155	590
761000570	540	761000653	548	761000862	506	761001003	598	761001156	590
761000571	540	761000654	548	761000863	505	761001004	597	761001160	591
761000572	540	761000655	548	761000864	506	761001005	598	761001161	591
761000573	540	761000656	548	761000865	506	761001006	596	761001162	591
761000574	540	761000657	548	761000866	506	761001007	599	761001163	591
761000575	540	761000658	548	761000867	506	761001008	600	761001164	591
761000576	540	761000659	548	761000868	506	761001009	597	761001165	591
761000577	562	761000660	548	761000869	506	761001010	598	761001166	588
761000578	562	761000661	548	761000870	505	761001011	596	761001167	588
761000579	562	761000662	548	761000871	506	761001012	599	761001168	588
761000580	562	761000681	563	761000872	506	761001013	600	761001172	590
761000581	540	761000682	563	761000873	506	761001014	597	761001173	590
761000582	540	761000734	563	761000874	506	761001015	598	761001174	590
761000583	540	761000735	563	761000875	506	761001016	596	761001177	591
761000584	540	761000736	563	761000876	506	761001017	599	761001178	591
761000585	540	761000737	563	761000879	555	761001018	600	761001179	591
761000586	540	761000738	563	761000880	555	761001019	597	761001180	591
761000587	540	761000739	563	761000881	555	761001020	596	761001181	591
761000588	540	761000740	563	761000882	555	761001021	599	761001182	591
761000589	540	761000741	563	761000883	555	761001022	600	761001183	588
761000590	540	761000743	563	761000884	555	761001024	597	761001184	588
761000591	540	761000744	563	761000885	555	761001025	596	761001185	588
761000592	540	761000745	532	761000887	555	761001026	599	761001189	590
761000593	540	761000746	532	761000888	555	761001027	600	761001190	590
761000594	562	761000747	532	761000889	555	761001028	597	761001191	590
761000595	562	761000748	532	761000890	555	761001029	596	761001195	591
761000596	562	761000749	532	761000891	555	761001030	599	761001196	591
761000597	562	761000750	532	761000893	555	761001031	600	761001197	591
761000600	562	761000751	532	761000894	555	761001059	580	761001198	591

Order nr.	Pag.	Order nr.	Pag.	Order nr.	Pag.	Order nr.	Pag.	Order nr.	Pag.
761033660	543	770103544	239	790001719	1092	790002989	1094	790007225	1117
761033661	543	770104033	239	790001720	1092	790002990	1094	790007226	1117
761033662	543	770105220	236	790001721	1092	790002991	1094	790007227	1091
761033663	543	770105244	239	790001722	1092	790002992	1094	790007228	1091
761033664	543	770106105	236	790001723	1092	790003006	1087	790007230	1093
761033665	543	770108010	236	790001724	1092	790003007	1087	790007231	1093
761033666	543	770108022	239	790001725	1092	790003008	1087	790007232	1093
761033667	547	770108033	239	790001726	1092	790003009	1087	790007234	1095
761033668	547	770108440	239	790001727	1092	790003010	1087	790007235	1095
761033669	547	770109999	236	790001728	1092	790003011	1087	790007236	1095
761033670	547	770203720	237	790001729	1092	790003012	1087	790007237	1095
761033671	547	770205220	237	790001730	1092	790003013	1089	790007238	1095
761033672	547	770301212	237	790001731	1092	790003014	1089	790007240	1095
761033673	547	770301222	239	790001732	1092	790003029	1094	790007241	1095
761033674	547	770301244	239	790001733	1092	790003030	1094	790007243	1095
761033675	547	770301616	237	790001734	1092	790003031	1094	790007244	1095
761033676	551	770301622	239	790001735	1092	790003032	1094	790007246	1095
761033677	551	770301644	239	790001736	1092	790003033	1094	790007247	1095
761033678	551	770302333	239	790001737	1092	790003034	1094	790007248	1095
761033679	551	770302344	239	790001738	1093	790003035	1094	790007250	1095
761033680	551	770308022	239	790001739	1093	790003036	1094	790007251	1095
761033681	551	770308044	239	790001740	1093	790003037	1094	790007252	1095
761033682	551	770308080	237	790001741	1093	790003068	1094	790007253	1095
761033683	551	770401212	237	790001742	1093	790003539	1087	790007254	1095
761033684	551	770401616	237	790001743	1093	790003540	1087	790007255	1096
761040001	601	770402320	237	790001744	1093	790003942	1117	790007256	1096
761040002	601	770408080	237	790001745	1093	790003943	1117	790007257	1096
761040003	601	770504022	239	790001746	1093	790003944	1117	790007258	1096
761040004	601	770504044	239	790001747	1093	790003945	1117	790007259	1096
761040005	601	770506022	239	790001748	1093	790003947	1117	790007260	1096
761040006	601	770506044	239	790001749	1093	790003948	1117	790007261	1096
761040007	601	770506060	237	790001750	1093	790003950	1117	790007262	1096
761040008	601	770508022	239	790001751	1093	790003952	1117	790007263	1096
761040020	582	770508044	239	790001752	1093	790003955	325	790007264	1096
761040021	582	770508080	237	790001753	1093	790003964	325	790007265	1096
761040022	584	770604060	237	790001754	1093	790004162	1099	790007266	1096
761040023	584	770606060	237	790001755	1093	790004164	1099	790007267	1096
761040024	583	770608080	237	790001756	1093	790004166	1099	790007268	1096
761040025	583	770702013	238	790001757	1093	790004167	1099	790007269	1096
761040026	582	770802013	238	790001758	1093	790004168	1099	790007270	1096
761040027	582	770902222	238	790001759	1093	790004169	1099	790007271	1096
761040028	584	771002222	238	790001760	1093	790004170	1099	790007272	1096
761040029	584	790000004	1105	790001761	1093	790004172	1099	790007288	1159
761040030	583	790000005	1105	790001998	1091	790004173	1099	790007305	1105
761040031	583	790000013	1105	790002000	1091	790004180	1099	790007306	1106
761040032	582	790000014	1105	790002001	1091	790004181	1099	790007307	1106
761040033	582	790000017	1106	790002003	1091	790004182	1099	790007308	1106
761040034	584	790000021	1106	790002004	1091	790004185	1099	790007314	1095
761040035	584	790000025	1107	790002006	1091	790004186	1099	790007315	1104
761040036	583	790000026	1107	790002007	1091	790004187	1099	790007317	1104
761040037	583	790000027	1107	790002019	1090	790004188	1099	790007319	1104
761040038	582	790000034	1106	790002026	1090	790004189	1099	790008000	1157
761040039	582	790000111	1102	790002051	1091	790004190	1099	790008001	1157
761040040	584	790000112	1102	790002052	1091	790004191	1099	790008002	1157
761040041	584	790000113	1102	790002053	1091	790004192	1099	790008007	1157
761040042	583	790000114	1102	790002056	1091	790004193	1099	790008008	1157
761040043	583	790000511	1118	790002057	1091	790004449	998	790008009	1157
761040044	582	790000593	1119	790002058	1091	790004450	998	790008010	1157
761040045	582	790000594	1119	790002076	1090	790004451	998	790008011	1157
761040046	584	790000595	1119	790002085	1090	790004454	998	790008012	1157
761040047	584	790000596	1119	790002934	1094	790004476	1099	790008013	1157
761040048	583	790000597	1119	790002935	1094	790004477	1099	790008014	1158
761040049	583	790001091	1105	790002936	1094	790004499	1094	790008015	1158
761040055	525	790001092	1105	790002937	1094	790004500	1094	790008016	1158
763504000	248	790001093	1105	790002938	1094	790004501	1094	790008017	1158
763505000	248	790001094	1105	790002939	1094	790004502	1094	790008018	1158
763506000	248	790001705	1092	790002949	1093	790004503	1094	790008024	1157
763606000	249	790001706	1092	790002950	1093	790004504	1094	790008025	1157
770101210	236	790001707	1092	790002952	1089	790004697	1097	790008026	1157
770101615	236	790001708	1092	790002953	1089	790004698	1097	790008027	1157
770101622	239	790001709	1092	790002955	1089	790007200	1121	790008028	1157
770101633	239	790001710	1092	790002956	1089	790007203	1101	790008030	1158
770101644	239	790001711	1092	790002957	1089	790007210	1091	790008031	1158
770102015	236	790001712	1092	790002958	1089	790007214	1097	790008032	1158
770102033	239	790001713	1092	790002959	1089	790007216	1097	790008033	1158
770102520	236	790001714	1092	790002960	1089	790007220	1099	790008034	1158
770102522	239	790001715	1092	790002961	1089	790007221	1099	790008035	1158
770102533	239	790001716	1092	790002962	1093	790007222	1117	790008036	1158
770102544	239	790001717	1092	790002963	1093	790007223	1117	790008037	1158
770103033	239	790001718	1092	790002975	1094	790007224	1117	790008038	1158

NUMERIEKE INDEX

Order nr.	Pag.	Order nr.	Pag.	Order nr.	Pag.	Order nr.	Pag.	Order nr.	Pag.
790008039	1158	790008149	1162	790008653	802	790023037	1088	790302564	1148
790008040	1157	790008150	1162	790008654	802	790023039	1091	790302565	1148
790008041	1157	790008151	1161	790008655	802	790023079	1087	790302600	1149
790008042	1157	790008152	1161	790008656	802	790023086	1088	790302601	1149
790008043	1157	790008153	1161	790008657	802	7900231123	971	790302631	1089
790008044	1157	790008154	1161	790008658	802	790023124	971	790302632	1090
790008045	1159	790008155	1162	790008659	802	790023125	971	790302633	1089
790008046	1159	790008156	1162	790008660	802	790024000	934	790302634	1090
790008047	1159	790008157	1162	790008661	802	790024004	1088	790302635	1089
790008048	1159	790008158	1162	790008662	802	790024018	1099	790302636	1090
790008049	1159	790008159	1162	790008663	802	790024020	1099	790302641	1146
790008053	1159	790008160	1162	790008664	802	790024022	1099	790302642	1146
790008057	1159	790008162	1162	790008665	802	790024032	1088	790302643	1146
790008058	1159	790008163	1162	790008666	802	790025111	806	790302644	1146
790008059	1159	790008164	1162	790008667	802	790025112	806	790302645	1146
790008060	1159	790008165	1162	790008668	802	790025113	806	790302646	1146
790008061	1159	790008166	1162	790008669	802	790025150	1145	790305002	1147
790008062	1159	790008167	1162	790008670	802	790025550	1156	790305004	1147
790008063	1160	790008173	1161	790008671	802	790030005	1133	790305012	1148
790008064	1159	790008174	1161	790008672	802	790030010	1134	790305013	1148
790008065	1159	790008175	1161	790008673	802	790030015	1134	790305014	1148
790008066	1159	790008176	1162	790008674	802	790030020	1132	790305015	1148
790008067	1159	790008177	1162	790008675	802	790030030	1132	790305016	1148
790008071	1160	790008178	1162	790008676	802	790030046	1132	790305017	1148
790008072	1159	790008179	1162	790008677	802	790030048	1132	790305018	1148
790008073	1160	790008180	1162	790008678	802	790302500	1146	790305019	1148
790008074	1160	790008181	1162	790008679	802	790302502	1147	790305020	1148
790008075	1160	790008182	1162	790008680	802	790302504	1147	790305021	1148
790008080	1160	790008183	1162	790008681	802	790302512	1148	790305022	1148
790008081	1160	790008184	1162	790008682	802	790302513	1148	790305023	1148
790008082	1160	790008185	1161	790008683	802	790302514	1148	790305024	1148
790008083	1160	790008186	1161	790008684	802	790302515	1148	790305025	1148
790008084	1160	790008187	1161	790008685	802	790302516	1148	790305026	1148
790008085	1160	790008188	1162	790008686	802	790302517	1148	790305027	1148
790008086	1160	790008189	1162	790008687	802	790302518	1148	790305028	1148
790008087	1160	790008190	1162	790008688	802	790302519	1148	790305029	1148
790008093	1160	790008191	1163	790008689	802	790302520	1148	790305030	1148
790008094	1160	790008192	1162	790008690	802	790302521	1148	790305031	1148
790008098	1160	790008193	1162	790008691	802	790302522	1148	790305032	1148
790008099	1160	790008194	1163	790008692	802	790302523	1148	790305033	1148
790008100	1160	790008195	1163	790008693	802	790302524	1148	790305034	1148
790008101	1160	790008196	1163	790008694	802	790302525	1148	790305035	1148
790008103	1160	790008198	1163	790008695	802	790302526	1148	790305036	1148
790008105	1160	790008200	1161	790008696	802	790302527	1148	790305037	1148
790008109	1160	790008201	1161	790008697	802	790302528	1148	790305038	1148
790008110	1160	790008202	1161	790008698	802	790302529	1148	790305039	1148
790008111	1160	790008203	1163	790008699	802	790302530	1148	790305040	1148
790008112	1160	790008204	1163	790008782	1081	790302531	1148	790305041	1148
790008113	1160	790008205	1163	790008784	1081	790302532	1148	790305042	1148
790008114	1160	790008210	1163	790008786	1080	790302533	1148	790305043	1148
790008115	1160	790008211	1163	790008794	1081	790302534	1148	790305044	1148
790008116	1160	790008212	1163	790008796	1081	790302535	1148	790305045	1148
790008117	1161	790008217	1163	790008801	1082	790302536	1148	790305046	1148
790008118	1161	790008218	1163	790008804	1082	790302537	1148	790305047	1148
790008119	1161	790008219	1163	790008807	1082	790302538	1148	790305048	1148
790008120	1161	790008220	1163	790008810	1082	790302539	1148	790305049	1148
790008121	1161	790008221	1163	790008812	1082	790302540	1148	790305050	1148
790008122	1161	790008222	1163	790008814	1083	790302541	1148	790305051	1148
790008123	1161	790008223	1163	790008816	1083	790302542	1148	790305052	1148
790008124	1161	790008224	1163	790008823	1084	790302543	1148	790305053	1148
790008126	1161	790008225	1163	790008825	1084	790302544	1148	790305054	1148
790008127	1161	790008226	1163	790008826	1084	790302545	1148	790305055	1148
790008128	1161	790008227	1163	790008828	1083	790302546	1148	790305056	1148
790008129	1161	790008228	1163	790008829	1083	790302547	1148	790305057	1148
790008132	1162	790008229	1161	790008830	1083	790302548	1148	790305058	1148
790008133	1162	790008230	1161	790008835	1084	790302549	1148	790305059	1148
790008134	1162	790008231	1161	790008836	1084	790302550	1148	790305060	1148
790008135	1162	790008232	1163	790008837	1084	790302551	1148	790305061	1148
790008136	1161	790008233	1163	790008838	1084	790302552	1148	790305062	1148
790008137	1161	790008234	1163	790008859	1085	790302553	1148	790305063	1148
790008138	1161	790008235	1163	790008860	1085	790302554	1148	790305064	1148
790008139	1161	790008236	1163	790008864	1085	790302555	1148	790305065	1148
790008140	1162	790008237	1163	790008865	1085	790302556	1148	790400002	849
790008141	1162	790008646	802	790008891	1085	790302557	1148	790400004	849
790008142	1162	790008647	802	790008892	1085	790302558	1148	790400006	849
790008143	1162	790008648	802	790008893	1085	790302559	1148	790400008	849
790008144	1161	790008649	802	790009015	1080	790302560	1148	790400010	849
790008145	1161	790008650	802	790010200	1158	790302561	1148	790400012	849
790008146	1161	790008651	802	790023034	1087	790302562	1148	790400014	849
790008148	1162	790008652	802	790023036	1088	790302563	1148	790400016	849

Order nr.	Pag.	Order nr.	Pag.	Order nr.	Pag.	Order nr.	Pag.	Order nr.	Pag.
790400018	849	790500068	852	790630800	1121	801001002	68	801200600	181
790400020	849	790500070	852	790630850	1121	801001003	68	801200601	181
790400022	849	790500072	852	790630900	1121	801001004	69	801200603	181
790400024	849	790500074	852	790630950	1121	801001005	69	801200604	181
790400026	849	790500076	852	790631000	1121	801001006	69	801200605	181
790400028	849	790500078	852	790631100	1121	801001007	69	801200742	82
790400030	849	790500080	852	790631200	1121	801007805	54	801200743	82
790400032	849	790500082	852	790631300	1121	801008211	71	801200746	87
790400034	849	790500084	852	790631400	1121	801008529	82	801200762	67
790400036	849	790500086	852	790631500	1121	801008531	82	801200763	65
790400038	849	790500088	852	790631600	1121	801008532	73	801200802	340
790400040	849	790500090	852	790631800	1121	801008532	82	801200802	340
790400042	849	790500092	852	790632000	1121	801008537	82	801200803	340
790400044	849	790500094	852	790632200	1121	801008539	82	801200803	340
790400046	849	790500096	852	790632400	1121	801008540	82	801200804	340
790400048	849	790500098	852	790632500	1121	801008553	82	801200804	340
790400050	849	790500100	852	790632600	1121	801008555	82	801200805	340
790400052	851	790500102	852	790632800	1121	801008556	82	801200805	340
790400054	851	790500104	852	790633000	1121	801008557	82	801200813	340
790400056	851	790500106	852	790700216	1093	801008558	82	801200813	340
790400058	851	790500108	852	790700304	1169	801008560	82	801200814	340
790400060	851	790500110	852	790700306	1169	801008561	82	801200814	340
790400062	851	790500112	852	790700308	1169	801008563	82	801200816	58
790400064	851	790500114	852	790700312	1169	801008564	82	801200848	57
790400066	851	790500116	852	794001150	856	801008565	82	801201232	95
790400068	851	790500118	852	794001200	856	801008567	82	801201233	95
790400070	851	790500120	852	794002150	857	801008568	82	801201234	95
790400072	851	790504002	853	794002200	857	801008569	71	801201237	95
790400074	851	790504004	853	794004150	858	801008572	71	801201238	95
790400076	851	790504024	853	800010770	259	801008574	71	801201333	95
790400078	851	790504032	853	800010780	259	801008575	71	801201334	95
790400080	851	790504034	853	800010790	259	801008576	71	801201337	95
790400082	851	790600102	1091	800170108	803	801008577	71	801202780	95
790400084	851	790600112	1159	800170110	803	801008578	71	801202781	95
790400086	851	790601102	827	800170150	804	801008593	87	801202783	95
790400088	851	790601135	827	800170155	804	801008594	87	801202785	95
790400090	851	790601172	827	800170160	804	801008596	87	801202786	95
790400092	851	790601213	827	800170225	823	801008597	87	802000105	259
790400094	851	790601269	827	800170300	868	801008598	87	802000107	259
790400096	851	790601337	827	800170305	868	801008600	85	802000505	259
790400098	851	790601424	827	800170310	868	801008600	87	802000520	259
790400100	851	790601483	827	800170313	869	801008602	87	802000542	259
790400102	851	790601603	827	800170715	924	801008604	87	803771021	818
790400104	851	790602102	827	800210029	837	801008613	82	803771049	819
790400106	851	790602135	827	800210031	837	801008614	82	803771061	820
790400108	851	790602172	827	800210033	837	801008615	82	803771073	821
790400110	851	790602213	827	800210035	837	801008616	82	803771204	818
790500002	850	790602269	827	800210037	837	801008617	82	815610008	412
790500004	850	790602337	827	800210039	837	801008618	87	815610009	412
790500006	850	790602424	827	800210041	837	801008620	95	815610018	412
790500008	850	790602483	827	800210043	837	801008621	93	815610099	412
790500010	850	790602603	827	800210045	837	801008621	95	815614011	272
790500012	850	790611102	825	800210053	837	801008622	95	815614021	272
790500014	850	790611135	825	800210055	837	801008657	82	815614031	272
790500016	850	790611172	825	800210057	837	801008658	82	815614041	272
790500018	850	790611213	825	800210060	838	801008659	82	815614051	272
790500020	850	790611269	825	800210062	838	801008660	82	815614061	272
790500022	850	790611337	825	800210064	838	801008661	87	815614066	272
790500024	850	790611424	825	800210066	838	801008662	87	815614110	493
790500026	850	790611483	825	800210068	838	801008663	87	815614120	493
790500028	850	790612102	825	800210070	838	801008664	95	815614150	493
790500030	850	790612135	825	800210072	838	801008665	95	829000015	356
790500032	850	790612172	825	800210074	838	801008666	95	829000035	356
790500034	850	790612213	825	800210076	838	801100166	267	829000100	745
790500036	850	790612269	825	800210078	838	801105600	269	829000110	745
790500038	850	790612337	825	800210080	838	801105600	275	829000120	745
790500040	850	790612424	825	800210082	838	801105750	268	829000160	781
790500042	850	790612483	825	800210084	838	801106000	268	829000182	746
790500044	850	790630200	1121	800210086	838	801106000	275	829000190	746
790500046	850	790630250	1121	800210088	838	801106010	353	829000192	746
790500048	850	790630300	1121	800210100	838	801106030	354	829010200	781
790500050	850	790630350	1121	800210102	838	801106032	352	829300184	759
790500052	850	790630400	1121	800210104	838	801106060	354	829300190	782
790500054	850	790630450	1121	800210106	838	801106065	352	829300192	783
790500056	852	790630500	1121	800210108	838	801106066	353	829300194	786
790500058	852	790630550	1121	800210110	838	801106067	353	829300196	784
790500060	852	790630600	1121	800210112	838	801200336	129	829300202	788
790500062	852	790630650	1121	800210114	838	801200341	129	829300205	790
790500064	852	790630700	1121	801000090	200	801200344	129	829300210	784
790500066	852	790630750	1121	801001001	68	801200375	147	829300220	792

NUMERIEKE INDEX

Order nr.	Pag.	Order nr.	Pag.	Order nr.	Pag.	Order nr.	Pag.	Order nr.	Pag.
829300222	775	830722800	759	830802188	769	830802558	770	830816212	753
829300224	775	830722818	760	830802208	769	830802559	770	830816213	753
829300226	775	830742040	774	830802214	775	830802605	747	830821011	758
829300227	775	830742058	765	830802220	765	830802607	765	830821012	759
829300252	785	830742065	774	830802222	765	830802665	747	830821054	755
829300258	791	830742082	759	830802232	765	830802678	771	830821055	755
829700000	628	830742180	759	830802233	765	830802679	771	830821056	755
829700003	629	830742181	759	830802234	765	830802693	748	830823007	777
829700006	628	830742182	759	830802235	765	830802695	747	830823015	776
829701002	620	830742183	759	830802236	765	830802708	761	830823016	776
829701003	620	830742184	759	830802237	765	830802737	766	830823017	776
829701004	620	830742185	759	830802238	765	830802739	766	830823252	777
829701005	620	830742186	759	830802239	765	830802748	766	830829327	741
829701006	620	830742187	759	830802240	765	830802749	766	830829382	743
829701007	620	830742188	759	830802241	765	830802765	766	830829383	743
829701008	620	830742237	774	830802242	765	830802766	759	830829384	743
829701009	621	830742239	774	830802243	765	830802780	747	830829440	748
829701010	621	830742381	774	830802244	765	830802781	747	830829444	748
829701011	621	830742384	765	830802245	765	830802793	749	830829446	748
829701012	621	830742402	759	830802246	765	830802794	749	830829447	748
829701013	621	830742405	759	830802247	765	830802817	761	830829512	744
829701014	621	830742412	760	830802248	765	830803066	740	830829516	744
829701015	621	830742413	760	830802249	765	830803150	778	830829517	744
829701016	623	830742422	760	830802250	765	830803151	778	830829558	745
829701017	623	830742423	765	830802251	765	830803152	778	830829560	745
829701018	623	830742424	765	830802252	765	830803153	778	830829565	739
829701019	623	830742427	765	830802253	765	830803154	778	830829566	739
829701021	623	830742431	765	830802255	749	830803155	778	830835012	777
829701022	622	830742901	759	830802256	749	830803156	778	830850000	763
829701023	622	830801000	754	830802257	749	830803158	778	830980320	765
829701024	622	830801003	754	830802258	749	830803159	778	830990703	770
829701025	622	830801081	754	830802259	749	830803508	771	84270107	338
829701026	622	830801093	754	830802260	749	830803509	771	84270206	338
829701027	622	830801095	754	830802265	749	830807023	742	84270305	338
829701028	622	830801096	754	830802273	759	830807024	742	84270404	338
829701029	622	830801097	765	830802293	778	830807026	742	84270503	338
830121003	749	830801102	754	830802295	778	830807027	742	84270602	338
830122438	749	830801400	778	830802296	778	830807045	742	845002010	457
830122452	749	830801401	778	830802297	778	830807063	743	845002011	457
830143276	778	830801402	778	830802298	778	830807540	743	845002012	457
830143593	778	830801403	778	830802299	778	830807545	742	845002013	457
830169190	749	830801412	778	830802300	778	830807547	742	850001001	357
830322905	765	830801420	778	830802301	778	830807549	742	850001003	357
830432160	761	830802029	749	830802302	778	830807550	742	850001004	357
830722000	770	830802032	760	830802303	778	830807551	742	850001006	358
830722077	760	830802036	759	830802304	778	830807553	736	850001007	357
830722119	761	830802037	759	830802319	749	830807555	740	850001008	357
830722120	761	830802043	778	830802339	778	830807559	736	850001010	357
830722121	761	830802051	768	830802395	768	830807560	737	850001011	358
830722149	760	830802061	768	830802396	768	830807562	738	850001012	358
830722151	760	830802062	768	830802415	765	830807563	738	850001018	358
830722332	774	830802064	768	830802420	774	830807564	737	850001019	358
830722333	774	830802076	774	830802422	775	830807570	741	850001020	358
830722334	774	830802077	774	830802423	775	830807571	741	850001501	358
830722341	761	830802078	774	830802425	774	830807572	740	850001502	358
830722343	761	830802079	774	830802428	774	830807573	740	85140101	344
830722346	761	830802080	775	830802429	775	830807576	740	855006610	282
830722415	760	830802081	774	830802434	769	830807577	740	855006611	282
830722416	760	830802082	774	830802439	769	830807582	739	855006612	284
830722423	760	830802083	774	830802485	774	830807583	739	855006614	286
830722437	760	830802092	775	830802489	765	830807584	739	855006615	286
830722516	760	830802096	774	830802495	769	830809200	754	855006618	288
830722552	760	830802114	749	830802496	769	830814193	754	855006908	276
830722553	760	830802115	759	830802515	749	830814196	754	855006913	278
830722556	760	830802119	774	830802516	749	830815038	762	855006916	281
830722563	765	830802122	774	830802517	747	830815088	773	855006917	280
830722597	760	830802123	775	830802527	749	830815332	763	855006919	277
830722680	760	830802126	774	830802528	749	830815476	763	855006925	279
830722681	760	830802127	774	830802529	749	830815493	773	855006968	281
830722682	760	830802128	774	830802530	749	830815957	762	855006969	280
830722684	760	830802129	749	830802531	749	830816050	756	855085500	711
830722685	760	830802131	749	830802532	749	830816051	756	856001000	492
830722686	760	830802132	768	830802533	770	830816052	757	856001103	274
830722689	760	830802133	768	830802534	770	830816053	757	856001104	275
830722705	760	830802145	769	830802535	770	830816054	756	856001105	274
830722792	760	830802146	769	830802538	770	830816059	758	856001106	274
830722793	760	830802147	759	830802539	770	830816202	752	856001110	492
830722795	760	830802148	759	830802543	770	830816203	752	856001117	274
830722797	760	830802179	769	830802545	357	830816204	752	856001120	492
830722798	759	830802181	769	830802550	771	830816211	752	856001130	494

Order nr.	Pag.	Order nr.	Pag.	Order nr.	Pag.	Order nr.	Pag.	Order nr.	Pag.
856001140	273	860000346	360	860002243	363	87499102	317	96150107	319
856001145	273	860000347	360	860002243	771	87499103	317	96150206	319
856001148	273	860000348	360	860002244	363	87620050	323	96150305	319
856001155	273	860000438	360	860002244	771	891002489	869	96150404	319
856001165	275	860000439	360	860002245	363	891020430	1089	96230107	320
856001166	275	860000440	360	860002245	771	891024558	869	96230206	320
856001167	275	860000441	360	860002246	363	891565382	1135	96230305	320
856001168	490	860000442	360	860002246	771	891565383	1135	96640107	318
856001169	490	860000443	360	860002247	363	891565384	1135	96640206	318
856001170	490	860000444	360	860002247	771	891566238	869	96640305	318
856001173	490	860000445	360	860002338	361	891566239	869	96640404	318
856001177	489	860000446	360	860002339	361	909061000	1100	96760103	318
856001178	489	860000447	360	860002340	361	909061250	1100	97170104	328
856001184	490	860001035	363	860002341	361	909061500	1100	97170203	328
856001200	492	860001036	363	860002342	361	909061750	1100	97390108	343
856001201	492	860001037	363	860002343	361	909070750	1100	97390207	343
856001210	492	860001038	363	860002344	361	909071000	1100	97541007	337
856001211	492	860001039	363	860002345	361	909071250	1100	998140005	432
856001300	492	860001040	363	860002346	361	909071500	1100	998140007	432
856001301	492	860001041	363	860002347	361	909072000	1100	998140013	432
856001310	492	860001042	363	860002438	361	909072500	1100	998140030	432
856001312	493	860001043	363	860002439	361	909079100	1100	998140032	432
856001313	493	860001044	363	860002440	361	909079150	1100	998320067	619
856001325	491	860001045	363	860002441	361	910000210	772	998320109	619
856001326	489	860001046	363	860002442	361	910000211	772	99960106	221
856001328	489	860001047	363	860002443	361	910000216	431	99960155	219
856001342	489	860001048	363	860002444	361	910000217	431	99960171	219
856001345	491	860001135	363	860002445	361	910000218	431	99960205	221
856001346	491	860001136	363	860002446	361	910000250	626	99960304	221
856001347	491	860001137	363	860002447	361	910000251	626	99960502	221
856001350	491	860001138	363	860002538	361	910000252	626		
856001351	489	860001139	363	860002539	361	910000253	626		
856001356	275	860001140	363	860002540	361	910000254	627		
856001357	275	860001141	363	860002541	361	910000255	627		
856001360	485	860001142	363	860002542	361	910000256	627		
856001361	485	860001143	363	860002543	361	910000257	626		
856001364	485	860001144	363	860002544	361	910000258	626		
856001365	485	860001145	363	860002545	361	910000259	626		
856001366	485	860001146	363	860002546	361	910000260	626		
856001367	485	860001147	363	860002547	361	910000261	626		
856001370	484	860001148	363	860002638	362	910000262	626		
856001371	484	860001838	360	860002639	362	910000263	626		
856001374	484	860001839	360	860002640	362	910000264	626		
856001375	484	860001840	360	860002641	362	940001010	412		
856001450	486	860001841	360	860002642	362	940001239	408		
856001451	486	860001842	360	860002643	362	940014014	412		
856001452	486	860001843	360	860002644	362	940014015	412		
856001453	486	860001844	360	860002645	362	940014016	412		
856001454	487	860001845	360	860002646	362	940014017	412		
856001455	487	860001846	360	860002738	362	940014331	354		
856001456	487	860001847	360	860002739	362	95380101	317		
856001457	487	860001938	360	860002740	362	95380200	317		
856001458	488	860001939	360	860002741	362	95380309	317		
856001504	489	860001940	360	860002742	362	95380408	317		
856001505	489	860001941	360	860002743	362	95420105	317		
856001507	489	860001942	360	860002744	362	95420204	317		
856001551	489	860001943	360	860002745	362	95420303	317		
856001580	272	860001944	360	860002746	362	95420402	317		
856001582	272	860001945	360	860002838	362	95440103	318		
856001583	272	860001946	360	860002839	362	95440202	318		
856001585	272	860001947	360	860002840	362	95450102	318		
856001586	272	860002138	363	860002841	362	95450201	318		
860000038	361	860002139	363	860002842	362	95450300	318		
860000039	361	860002140	363	860002843	362	95450409	318		
860000040	361	860002141	363	860002844	362	95450508	318		
860000041	361	860002142	363	860002845	362	95450607	318		
860000042	361	860002143	363	860002846	362	95450706	318		
860000043	361	860002144	363	860002847	362	95451200	318		
860000044	361	860002145	363	860002938	362	95451400	318		
860000045	361	860002146	363	860002939	362	95451600	318		
860000046	361	860002147	363	860002940	362	95451800	318		
860000047	361	860002148	363	860002941	362	95452000	318		
860000338	360	860002239	363	860002942	362	95480109	318		
860000339	360	860002239	771	860002943	362	95640108	319		
860000340	360	860002240	363	860002944	362	96020801	450		
860000341	360	860002240	771	860002945	362	96020802	451		
860000342	360	860002241	363	860002946	362	96020803	451		
860000343	360	860002241	771	860002947	362	96020804	451		
860000344	360	860002242	363	86970100	219	96130109	319		
860000345	360	860002242	771	87499101	317	96140108	319		

TENG TOOLS

Van motor race en zeilteams tot booreilanden en overheidsinstellingen; Teng Tools maakt er een gewoonte van te werken met winnaars. Teng Tools krijgt de voorkeur bij industriële kopers overal ter wereld. Grote autoconstructeurs en ook kleinere productiebedrijven vertrouwen op Teng Tools. Teng Tools is blij de smaak van de overwinning met hen te delen.

Arbeiders en race teams met hoge verwachtingen onderwerpen de Teng Tools producten aan alle mogelijke omstandigheden.

En ze blijven winnen..., dus Teng Tools moet wel de juiste aanpak hebben!



POLE POSITION ACCORDING TO TENG



OLE JOHAN, Chief Mechanic

Petter Solbergs rallycross car is maintained by me and my Teng Tools storage unit TCMM1055N. It's filled with 1055 pieces in 51 tool sets. All chosen by me, according to my preferences. For some, things organised perfectly might seem boring, but when it comes to chasing seconds, it's vital. Welcome to our world!

Get organised™



Gereedschapskoffers & -wagens

TENGOOLS



Kunststof opberglade. Met aluminium hendel.

Kenmerken:

- Rubbermat onderaan in de lade en rubber anti-slip voetjes.
- Kan gebruikt worden in de Teng koffers.
- Ideaal om een weinig materiaal ter plaatse mee te nemen.

Order nr.	117570101 ⓘ		
Orig. nr.		TCA05	
Gewicht	kg	0,50	
Afmetingen (l x b x h)	mm	476 x 202 x 80	
Prijs	€	18,50	

TENGOOLS



Lege service case.

Kenmerken:

- Numerisch slot.
- Geschikt voor 3x3 Teng tools TC trays.
- Op rubberen wielen.
- Met stevig uitschuifbaar handvat en 2 draaghandvaten.

Order nr.	144070109 ⓘ		
Orig. nr.		TC-SC	
Gewicht	kg	6,40	
Afmetingen (l x b x h)	mm	527 x 385 x 197	
Prijs	€	215,00	

TENGOOLS



Kunststof opbergkoffer.

Geschikt voor:

- 3 Teng Tools TC trays.

Order nr.	114640105 ⓘ		
Orig. nr.		TC-3	
Gewicht	kg	1,40	
Afmetingen (l x b x h)	mm	470 x 320 x 65	
Prijs	€	18,90	

TENGOOLS



Gereedschapstas in polyester.

Kenmerken:

- Kan gebruikt worden als rugzak.

Order nr.	173150103 ⓘ		
Orig. nr.		TCSB	
Gewicht	kg	1,29	
Afmetingen (l x b x h)	mm	380 x 230 x 430	
Prijs	€	61,50	

TENGOOLS



Gereedschapstas in polyester.

Kenmerken:

- Met metalen draaghandvat en schouderband.
- In het onderste compartiment passen 3 TC-trays.

Order nr.	173150202 ⓘ		
Orig. nr.		TCSB16	
Gewicht	kg	2,98	
Afmetingen (l x b x h)	mm	410 x 280 x 300	
Prijs	€	68,50	

TENGOOLS



Mecca Rosso toolbox.

Kenmerken:

- Met 2 openklapbare zijanten.
- Geleverd met mat onderaan, opberglade, 2 uitneembare alu-rails
- L. 430mm
- 3x30 dopclips 1/4", 3/8" en 1/2".

Order nr.	35880202 ⓘ		
Orig. nr.		TC450	
Gewicht	kg	5,50	
Afmetingen (l x b x h)	mm	450 x 200 x 200	
Prijs	€	69,90	

TENGOOLS



Gereedschapskoffer met 3 afsluitbare rolgelagerde lades.

Kenmerken:

- Geleverd met een EVA-rubber mat op de bovenkant als tussenmat indien de koffer wordt gebruikt samen met een topbox.
- Slot met 2 sleutels.

Geschikt voor:

- Iedere lade is geschikt voor 4 TC trays.

Order nr.	166820100	
Orig. nr.	TC803SV	
Aantal laden	3	
Afmetingen middelgrote lade	mm	572x270x50 (x2)
Afmetingen grote lade	mm	572x270x75 (x1)
Maximum gewicht per lade	kg	20
Gewicht	kg	13,80
Afmetingen (l x b x h)	mm	660 x 305 x 250
Prijs	€	134,00

TENGOOLS



Gereedschapskoffer. Serie 8 met 3 afsluitbare rolgelagerde lades.

Kenmerken:

- Geleverd met een EVA-rubber mat op de bovenkant als tussenmat indien de koffer wordt gebruikt samen met een topbox.
- Met numerisch slot.

Geschikt voor:

- Iedere lade is geschikt voor 4 TC trays.

Order nr.	122360100	
Orig. nr.	TC803N	
Aantal laden	3	
Afmetingen middelgrote lade	mm	572x270x50 (x12)
Afmetingen grote lade	mm	572x270x75 (x1)
Maximum gewicht per lade	kg	20
Gewicht	kg	13,80
Afmetingen (l x b x h)	mm	660 x 305 x 250
Prijs	€	169,00

TENGOOLS



Gereedschapskoffer. Serie 8 met 3 afsluitbare rolgelagerde lades.

Kenmerken:

- Grijs-metaalkleurige afwerking.
- Geleverd met een EVA-rubber mat op de bovenkant als tussenmat indien de koffer wordt gebruikt samen met de topbox TC804NS.
- Sleutelslot.

Geschikt voor:

- Iedere lade is geschikt voor 4 TC trays.

Order nr.	139610109	
Orig. nr.	TC803NS	
Aantal laden	3	
Afmetingen middelgrote lade	mm	572x270x50 (x2)
Afmetingen grote lade	mm	572x270x75 (x1)
Maximum gewicht per lade	kg	20
Gewicht	kg	13,80
Afmetingen (l x b x h)	mm	660 x 305 x 250
Prijs	€	169,00

TOOLS

TENGTTOOLS



Gereedschapskoffer. Serie 8 met 4 afsluitbare rolgelagerde lades.

Kenmerken:

- Grijs-metaalkleurige afwerking.
- Sleutelslot.

Geschikt voor:

- Iedere lade is geschikt voor 4 TC trays.

Order nr.	143790103
Orig. nr.	TC804NS
Aantal lades	4
Afmetingen middelgrote lade	mm 572x270x50 (x3)
Afmetingen grote lade	mm 572x270x75 (x1)
Maximum gewicht per lade	kg 20
Gewicht	kg 21,00
Afmetingen (l x b x h)	mm 660 x 305 x 380
Prijs	€ 219,00

TENGTTOOLS



Gereedschapskoffer. Serie 8 met 6 rolgelagerde lades.

Kenmerken:

- Speciale oranje KTM uitvoering.
- Met een afsluitbaar deksel dat alle lades bedekt eenmaal de koffer gesloten is.
- Twee stevige handvaten aan de zijkanten.
- Sleutelslot.

Order nr.	801007805
Orig. nr.	TC806NO
Aantal lades	6
Afmetingen kleine lade	mm 170x275x50 (x3)
Afmetingen middelgrote lade	mm 569x275x50 (x2)
Afmetingen grote lade	mm 569x275x75 (x1)
Maximum gewicht per lade	kg 20
Gewicht	kg 22,00
Afmetingen (l x b x h)	mm 660 x 305 x 380
Prijs	€ 265,00

TENGTTOOLS



Gereedschapskoffer. Serie 8 met 4 afsluitbare rolgelagerde lades.

Kenmerken:

- Met cijferslot.

Geschikt voor:

- Iedere lade is geschikt voor 4 TC-Trays.

Order nr.	122370109
Orig. nr.	TC804N
Aantal lades	4
Afmetingen middelgrote lade	mm 572x270x50 (x3)
Afmetingen grote lade	mm 572x270x75 (x1)
Maximum gewicht per lade	kg 20
Gewicht	kg 21,00
Afmetingen (l x b x h)	mm 660 x 305 x 380
Prijs	€ 219,00

TENGTTOOLS



Gereedschapskoffer met 6 rolgelagerde lades.

Kenmerken:

- Slot met twee sleutels.
- Met een afsluitbaar deksel dat alle lades bedekt eenmaal de koffer gesloten is.
- Twee stevige handvaten aan de zijkanten.

Order nr.	162620108
Orig. nr.	TC806SV
Aantal lades	6
Afmetingen kleine lade	mm 170x275x50 (x3)
Afmetingen middelgrote lade	mm 569x275x50 (x2)
Afmetingen grote lade	mm 569x275x75 (x1)
Maximum gewicht per lade	kg 20
Gewicht	kg 23,40
Afmetingen (l x b x h)	mm 660 x 307 x 374
Prijs	€ 205,00

TENGOOLS



Gereedschapskoffer. Serie 8 met 6 rolgelagerde lades.

Kenmerken:

- Met cijferslot.
- Met een afsluitbaar deksel dat alle lades bedekt eenmaal de koffer gesloten is.
- Twee stevige handvaten aan de zijkanten.

Order nr.	122160104
Orig. nr.	TC806NF
Aantal lades	6
Afmetingen kleine lade	mm 170x275x50 (x3)
Afmetingen middelgrote lade	mm 569x275x50 (x2)
Afmetingen grote lade	mm 569x275x75 (x1)
Maximum gewicht per lade	kg 20
Gewicht	kg 23,40
Afmetingen (l x b x h)	mm 305 x 660 x 380
Prijs	€ 265,00

TENGOOLS



Gereedschapskoffer SV serie met 5 lades.

Kenmerken:

- Met stevige handvaten aan de zijkanten.
- 5 diepe lades met kogelgelagerde glijbanen. 1 lade kan 4TC trays + 1 TTX tray bevatten.
- Met een afsluitbaar deksel dat alle lades bedekt eenmaal de koffer gesloten is.
- Met sleutelslot

Order nr.	238040109
Orig. nr.	TC805SV
Aantal lades	5
Afmetingen kleine lade	mm 576x410x50
Afmetingen middelgrote lade	mm 576x410x75
Gewicht	kg 42,50
Afmetingen (l x b x h)	mm 660 x 455 x 483
Prijs	€ 395,50



PETTER SOLBERG
WORLD RX CHAMPION #2

TOOLS

TENGOOLS



Gereedschapskoffer. Serie 8 met 5 afsluitbare rolgelagerde lades.

Kenmerken:

- Maximum gewicht per lade 20kg.
- Diepe uitvoering: 1 lade kan 4 TC-trays + 1 TTX-Tray bevatten.
- Met een afsluitbaar deksel dat alle lades bedekt eenmaal de koffer gesloten is.
- Twee stevige handvaten aan de zijkanten.
- Met cijferslot.

Order nr.	122190101
Orig. nr.	TC805NFX
Aantal lades	5
Afmetingen middelgrote lade	mm 576x410x50 (x2)
Afmetingen grote lade	mm 576x410x75 (x3)
Maximum gewicht per lade	kg 20
Gewicht	kg 44,00
Afmetingen (l x b x h)	mm 660 x 455 x 490
Prijs	€ 479,00

TENGOOLS



Gereedschapswagen Serie 8 met 3 afsluitbare rolgelagerde lades en 1 afsluitbare kast.

Kenmerken:

- Met 2 cijfersloten.
- 2 vaste wielen, 2 draaibare wielen met rem.

Order nr.	03450103
Orig. nr.	TCW803N
Aantal lades	3
Afmetingen middelgrote lade	mm 575x380x75 (x2)
Afmetingen grote lade	mm 575x380x150 (x1)
Maximum gewicht per lade	kg 25
Gewicht	kg 43,40
Afmetingen (l x b x h)	mm 670 x 460 x 760
Prijs	€ 444,00

TENGOOLS



Gereedschapswagen. Serie 8 met 4 afsluitbare rolgelagerde lades.

Kenmerken:

- Met cijferslot.
- 2 vaste wielen, 2 draaibare wielen met rem.

Order nr.	161640107
Orig. nr.	TCW804N
Aantal lades	4
Afmetingen middelgrote lade	mm 576x380x75 (x3)
Afmetingen grote lade	mm 576x380x312 (x1)
Maximum gewicht per lade	kg 25
Gewicht	kg 49,00
Afmetingen (l x b x h)	mm 670 x 460 x 812
Prijs	€ 431,00

TENGOOLS



Gereedschapswagen. Serie 8 met 6 afsluitbare rolgelagerde lades.

Kenmerken:

- Met cijferslot.
- 2 vaste wielen, 2 draaibare wielen met rem.

Order nr.	122170103
Orig. nr.	TCW806N
Aantal lades	6
Afmetingen middelgrote lade	mm 575x380x75 (x5)
Afmetingen grote lade	mm 575x380x150 (x1)
Maximum gewicht per lade	kg 25
Gewicht	kg 59,00
Afmetingen (l x b x h)	mm 670 x 460 x 780
Prijs	€ 489,00

TENGOOLS



Gereedschapswagen. Serie 8 met 6 afsluitbare rolgelagerde lades.

Kenmerken:

- Met cijferslot.
- 2 vaste wielen, 2 draaibare wielen met rem.

Order nr.	161630108
Orig. nr.	TCW806N1
Aantal lades	6
Afmetingen middelgrote lade	mm 576x380x75 (x5)
Afmetingen grote lade	mm 576x380x312 (x1)
Maximum gewicht per lade	kg 25
Gewicht	kg 61,20
Afmetingen (l x b x h)	mm 670 x 460 x 960
Prijs	€ 525,00

TENGOOLS



NEW

Gereedschapswagen. Serie 7 met 7 afsluitbare rolgelagerde lades.

Kenmerken:

- Met sleutelslot
- 2 vaste wielen, 2 draaibare wielen met rem

Order nr.	207830104
Orig. nr.	TCW707EV
Aantal laden	7
Afmetingen middelgrote lade	mm 575x380x75
Afmetingen grote lade	mm 575x380x150
Maximum gewicht per lade	kg 20
Gewicht	kg 58,00
Prijs	€ 479,00

TENGOOLS



Gereedschapswagen Serie 8.

- 7 afsluitbare rolgelagerde lades.
- witte uitvoering.
- Met cijferslot.
- 2 vaste wielen, 2 draaibare met rem.

Order nr.	801200848
Orig. nr.	TCW807NW
Aantal laden	7
Afmetingen middelgrote lade	mm 575x380x75 (x5)
Afmetingen grote lade	mm 575x380x150 (x2)
Maximum gewicht per lade	kg 25
Gewicht	kg 64,00
Prijs	€ 549,00

TOOLS

TENGOOLS



Gereedschapswagen. Serie 8 met 7 afsluitbare rolgelagerde lades.

Kenmerken:

- Met cijferslot.
- 2 vaste wielen, 2 draaibare wielen met rem.

Order nr.	122180102
Orig. nr.	TCW807N
Aantal laden	7
Afmetingen middelgrote lade	mm 575x380x75 (x5)
Afmetingen grote lade	mm 575x380x150 (x2)
Maximum gewicht per lade	kg 25
Gewicht	kg 75,00
Afmetingen (l x b x h)	mm 670 x 460 x 950
Prijs	€ 539,00

TENGOOLS



Gereedschapswagen. Serie 8 met 7 afsluitbare rolgelagerde lades.

Kenmerken:

- Grijs-metaalkleurige afwerking.
- Met cijferslot.
- 2 vaste wielen, 2 draaibare wielen met rem.

Order nr.	801200743
Orig. nr.	TCW807NS
Aantal laden	7
Afmetingen middelgrote lade	mm 575x380x75 (x5)
Afmetingen grote lade	mm 575x380x150 (x2)
Maximum gewicht per lade	kg 25
Gewicht	kg 64,00
Afmetingen (l x b x h)	mm 670 x 460 x 950
Prijs	€ 549,00

TENGTTOOLS



NEW

Gereedschapswagen met 7 lades.

Kenmerken:

- Soft closing systeem
- 2 zwenkwielen met rem
- 7 afsluitbare lades met rolgelagerde geleiders
- Cijferslot
- Elke lade met beschermende mat in de bodem

Order nr.	237840103	
Orig. nr.	TCW907X	
Capaciteit lades	kg	25
Gewicht	kg	64,80
Afmetingen (l x b x h)	mm	460 x 670 x 960
Prijs	€	684,60

TOOLS

TENGTTOOLS



Gereedschapswagen. Serie 8 met 10 afsluitbare rolgelagerde lades.

Kenmerken:

- Met cijferslot.
- 2 vaste wielen, 2 draibare wielen met rem.

Order nr.	122380108	
Orig. nr.	TCW810N	
Aantal lades	10	
Afmetingen kleine lade	mm	575x380x50 (x6)
Afmetingen middelgrote lade	mm	575x380x75 (x3)
Afmetingen grote lade	mm	575x380x150 (x1)
Maximum gewicht per lade	kg	25
Gewicht	kg	68,50
Afmetingen (l x b x h)	mm	670 x 460 x 950
Prijs	€	625,00

TENGTTOOLS



Gereedschapswagen. Serie 8 met 8 afsluitbare rolgelagerde lades.

Kenmerken:

- Met cijferslot.
- 2 vaste wielen, 2 draibare wielen met rem.

Order nr.	128730108	
Orig. nr.	TCW808N	
Aantal lades	8	
Afmetingen middelgrote lade	mm	575x380x75 (x7)
Afmetingen grote lade	mm	575x380x154 (x1)
Maximum gewicht per lade	kg	25
Gewicht	kg	61,00
Afmetingen (l x b x h)	mm	670 x 460 x 950
Prijs	€	589,00

TENGTTOOLS



Combinatie van TC806SV + TC803SV + TCW707EV.

Kenmerken:

- Met sleutelslot.
- 2 vaste wielen, 2 draibare wielen met rem.

Order nr.	801200816	
Orig. nr.	TCW816SV	
Aantal lades	16	
Gewicht	kg	97,00
Afmetingen (l x b x h)	mm	670 x 460 x 1575
Prijs	€	865,00

TENGOOLS



Gereedschapskoffer met 4 afsluitbare rolgelagerde lades.

Kenmerken:

- Twee stevige handvaten aan de zijanten.
- Met cijferslot.

Order nr.	167440106
Orig. nr.	TC804LN
Aantal lades	4
Afmetingen middelgrote lade	mm 1216x380x65 (x3)
Afmetingen grote lade	mm 1216x380x100 (x1)
Maximum gewicht per lade	kg 40
Gewicht	kg 67,00
Afmetingen (l x b x h)	mm 1340 x 457 x 440
Prijs	€ 779,00

TENGOOLS



NEW

Gereedschapskoffer met 10 rolgelagerde lades.

Kenmerken:

- Met een afsluitbaar deksel dat alle lades bedekt eenmaal de koffer gesloten is.
- 2 stevige handvaten aan de zijanten.
- Slot met twee sleutels.

Order nr.	199620105
Orig. nr.	TC810N
Aantal lades	10
Afmetingen grote lade	mm 576x380x75
Maximum gewicht per lade	kg 20
Gewicht	kg 101,00
Afmetingen (l x b x h)	mm 1337 x 455 x 560
Prijs	€ 999,00

TENGOOLS



Brede gereedschapswagen serie 8 met 6 afsluitbare rolgelagerde lades.

Kenmerken:

- Met houten topblad.
- Gepatenteerd systeem waarbij max. 1 lade per keer kan geopend worden.
- Lades met versterking.
- Met cijferslot.
- Max. gewicht bij gelijke verdeling over de lade.

Order nr.	151340106
Orig. nr.	TCW806LN
Aantal lades	6
Afmetingen kleine lade	mm 1216x380x65 (x3)
Afmetingen middelgrote lade	mm 1216x380x100 (x1)
Afmetingen grote lade	mm 1216x380x154 (x2)
Maximum gewicht per lade	kg 60-40-50
Gewicht	kg 121,00
Afmetingen (l x b x h)	mm 1350 x 460 x 950
Prijs	€ 1.299,00

TENGOOLS



Brede gereedschapswagen. Serie 8 met 9 afsluitbare rolgelagerde lades waarvan 1 super grote dubbele lade cap. 40kg.

Kenmerken:

- Met een houten topblad.
- Met cijferslot.
- Max. gewicht bij gelijke verdeling lade.

Order nr.	151350105
Orig. nr.	TCW809N
Aantal lades	9
Afmetingen kleine lade	mm 576x380x75 (x6)
Afmetingen middelgrote lade	mm 576x380x154 (x2)
Afmetingen grote lade	mm 1216x380x124 (x1)
Maximum gewicht per lade	kg 40-25-25
Gewicht	kg 136,00
Afmetingen (l x b x h)	mm 1350 x 460 x 950
Prijs	€ 1.415,00

Accessoires

TENGTOLS



TCW-CAB01 TCW-CAB01 TCW-CAB01

Side kast voor gereedschapswagens Teng Tools.

Order nr.	174670109	174680108	174690107
Orig. nr.	TCW-CAB01	TCW-CAB02	TCW-CAB03
Gewicht	kg 40,50	29,00	22,60
Afmetingen (l x b x h)	mm 382 x 460 x 795	382 x 460 x 795	382 x 460 x 795
Prijs	€ 469,00	287,00	228,00

TENGTOLS



Afsluitbare kast om aan de zijkant van de gereedschapswagen te bevestigen. Bevestigingsmoeren en plank worden meegeleverd.

Order nr.	112550108
Orig. nr.	TCW-CAB
Gewicht	kg 6,50
Afmetingen (l x b x h)	mm 400 x 200 x 500
Prijs	€ 75,50

TENGTOLS



Afsluitbare kast. Te gebruiken als muurkast of te plaatsen bovenop de Teng Tools gereedschapswagens. TCB80 past ook op de tussenkoffers met cijferslot.

Order nr.	174660100	174660209
Orig. nr.	TCB80	TCB80A
Gewicht	kg 15,00	16,50
Afmetingen (l x b x h)	mm 660 x 305 x 600	660 x 455 x 600
Prijs	€ 287,00	383,00

TENGTOLS



Roestvrijstalen schotel met 1 ronde magneet ingebouwd aan de onderkant. Deze onderkant is voorzien van een beschermende laag om schade aan bvb het wagenoppervlak te vermijden. Een prima werkinstrument om kleine zaken zoals schroeven, bouten, moeren e.d. samen te houden. Kan ook omgekeerd en zijdelings worden gebruikt. Rond model diam. 150mm.

Order nr.	15610108
Orig. nr.	580
Diameter	mm 150
Gewicht	kg 0,38
Afmetingen (l x b x h)	mm 157 x 42 x 157
Prijs	€ 12,90

TENGTOLS



Vierkante magnetische schotel 295x270mm. Grote magnetische roestvrijstalen schotel met 4 magneten met kunststof bedekt om de lak van de wagen niet te beschadigen.

Order nr.	186870101
Orig. nr.	580S
Gewicht	kg 1,00
Afmetingen (l x b x h)	mm 295 x 270 x 42
Prijs	€ 37,90

TENGTOLS



Roestvrijstalen schotel met 2 ronde magneten ingebouwd aan de onderkant. Deze onderkant is voorzien van een beschermende laag om schade aan bvb het wagenoppervlak te vermijden. Een prima werkinstrument om kleine zaken zoals schroeven, bouten, moeren e.d. samen te houden. Kan ook omgekeerd en zijdelings worden gebruikt. Rechthoekig model 320x150mm.

Order nr.	118470103
Orig. nr.	580A
Gewicht	kg 0,87
Afmetingen (l x b x h)	mm 325 x 150 x 70
Prijs	€ 27,50

TENGTOLS



Bakje met magnetische bevestiging. Voor plaatsing aan de zijkant van bvb een gereedschapswagen of paneel.

Order nr.	117880104	117880203
Orig. nr.	580C	580D
Gewicht	kg 0,96	0,69
Afmetingen (l x b x h)	mm 310 x 115 x 30	210 x 115 x 30
Prijs	€ 31,90	26,50

TENGTOLS



Magnetische spuitbushouder.

Order nr.	160730107
Orig. nr.	580J
Gewicht	kg 2,11
Afmetingen (l x b x h)	mm 410 x 90 x 100
Prijs	€ 40,50

TENGTOLS



PVC kom met een sterke magneet voor bevestiging aan gereedschapswagens, gereedschap paneel, ...

Order nr.	174610204
Orig. nr.	580R
Diameter	mm 150
Gewicht	kg 0,37
Afmetingen (l x b x h)	mm 160 x 150 x 130
Prijs	€ 15,50

TENGTOLS



Zijtafel- en papierhouder. Geschikt om te bevestigen aan de zijkant van een Teng Tools gereedschapswagen.

Order nr.	117560102
Orig. nr.	TCA01
Afmetingen tafel	mm 370x370
Gewicht	kg 6,00
Prijs	€ 95,50

TENGTOLS

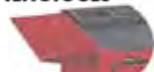

Zijtafel voor Teng Tools gereedschapswagens.

Order nr.	186250106
Orig. nr.	TCA02
Gewicht	kg 3,00
Afmetingen (l x b x h)	mm 455 x 300 x 0
Prijs	€ 49,90

TENGOOLS



Plastieken beschermingsmat met magnetische strips. Gebruikt ter bescherming van het koetswerk bij het herstellen van de wagen.

Order nr.	109480103		
Orig. nr.	FC01		
Gewicht	kg	0,75	
Afmetingen (l x b x h)	mm	1070 x 25 x 400	
Prijs	€	41,50	

TENGOOLS



Set om compartimenten te creëren voor de lades van de Teng gereedschapswagens. Bestaande uit 2 latten van 570x40x3mm en 2 latten van 375x40x3mm.

Order nr.	122250103		
Orig. nr.	TCDIVL		
Gewicht	kg	0,23	
Afmetingen (l x b x h)	mm	570 x 40 x 3	
Prijs	€	4,60	

TENGOOLS



Set om compartimenten te creëren voor de lades van de Teng top en tussen koffers. Bestaat uit 2 latten van 570x40x3mm en 2 latten van 272x40x3mm.

Order nr.	122240104		
Orig. nr.	TCDIVS		
Gewicht	kg	0,21	
Afmetingen (l x b x h)	mm	570 x 40 x 3	
Prijs	€	4,10	

TENGOOLS



ABS-plaat. Voor plaatsing op de bovenkant van de Teng gereedschapswagens als bescherming. Voorzien van 8 kleine compartimenteringen.

Order nr.	112540109		
Orig. nr.	ABSTOP		
Gewicht	kg	0,65	
Afmetingen (l x b x h)	mm	670 x 460 x 0	
Prijs	€	19,90	

TENGOOLS



Universele rubber anti-slipmat.

Kenmerken:

- Olie- en vetresistent
- Kan versneden worden om geplaatst te worden
- in gereedschapskoffers
- op gereedschapswagens
- in lades van gereedschapswagens

Order nr.	62460100		
Orig. nr.	TCMAT		
Gewicht	kg	0,10	
Afmetingen (l x b x h)	mm	2000 x 450 x 2	
Prijs	€	20,20	

TENGOOLS



Paneel met perforaties. Voor bevestiging van de Teng haken. Formaat past op alle zijkanten van de Teng Serie 7 en 8 gereedschapswagens. Voorzien van een uitvouwbaar voet om het paneel op zich alleen te gebruiken.

Order nr.	69940104		
Orig. nr.	TCWSP		
Gewicht	kg	6,72	
Prijs	€	86,50	

TENGOOLS



Haken voor montage op het TCW-SP paneel en Teng-werkbankpaneel. Verpakt per 10 st.

Order nr.	Orig. nr.	Omschrijving	Gewicht kg	Prijs €
69940252	TCW-HK02	dubbele haken	0,56	20,70
69940203	TCWHK10	haken 3x45° - 7x90°	0,10	17,60
69940278	TCW-HK20	haken 4x45° enkel - 4x45° dubbel 4x90° enkel - 4 kleine clips - 4 grote clips	0,83	39,70
69940302	TCW-HK45	haken 10x45°	0,44	17,60
69940401	TCW-HK90	haken 10x90°	0,44	17,60
69940500	TCWHKAIR	haken voor pneumatisch gereedschap	0,20	12,90
69940609	TCW-HKB	haken voor grote clips	0,30	26,70
69940708	TCW-HKS	haken voor kleine clips	0,30	26,70

TENGOOLS



Aluminium rail. Geschikt voor gebruik met clips om doppen van 1/4", 3/8" of 1/2" op te bevestigen. Geleverd zonder dopclips.

Order nr.	28930105	28930154	28930170
Orig. nr.	ALU430	ALU1000-1	ALU1000-4
Lengte	mm 430	1000	1000
Rijen voor clipsbevestiging	1	1	4
Gewicht	kg 0,04	0,09	0,79
Afmetingen (l x b x h)	mm 5 x 37 x 445	4 x 20 x 1000	
Prijs	€ 3,60	7,20	15,90

TENGOOLS



Dopclips voor aluminium rail ALU430x1000. Geschikt voor bevestiging van doppen op de hiervoor bestemde rail.

Order nr.	28930204	28930303	28930402	199610106
Orig. nr.	ALU14	ALU38	ALU12	ALU34
Aansluiting	inch 1/4	3/8	1/2	3/4
Gewicht	kg 0,01	0,02	0,02	1,00
Afmetingen (l x b x h)	mm 140 x 75 x 5	140 x 75 x 5	140 x 75 x 5	
Prijs	€ 2,00	2,00	2,00	5,50

TENGOOLS



Zijkast houder met wielen. Voor zijkasten TCW-CAB. Twee zwenkwielen met rem en twee vaste wielen.

Order nr.	186150108		
Orig. nr.	TCSMC		
Gewicht	kg	1,00	
Prijs	€	67,50	

GEREEDSCHAPSSETS

Teng Tools is uniek omdat het een compleet systeem aanbiedt, welke u in staat stelt om uw eigen gereedschapsset op een gestructureerde en zeer georganiseerde manier samen te stellen. Er is keuze uit verschillende types tool boxen en meer dan 100 verschillende tool trays. Om de keuze gemakkelijker te maken heeft Teng Tools een selectie van aanbevolen gereedschapssets samengesteld.

Van een kleine draagbare gereedschapsset tot de gigantische 1001 delige Mega Master; de aanbevolen sets zijn samengesteld in samenwerking met experts uit de automotive en industrie.





80 FH16



Get organised™



TENGOOLS



85-delige gereedschapskoffer. In een handige rode Teng koffer met vijf verdelingen (TC530).

De set bestaat uit sleutels, schroevendraaiers, tangen, slaggereedschap, service Tools en een doppenset 1/2".

Bestaande uit:

- 9-delige allensleutelset (1479MM - 112260104)
- Griptang (401-10 - 74250101)
- Universeel breekmes (710 - 105860100)
- Platte beitel 200 mm (CC200F - 117021006)
- Bankhamer (HMEG800 - 117030304)
- Kniptang (MB441-6T - 109740209)
- Combinatietang (MB452-7T - 109770206)
- Lange rechte bektang (MB461-8T - 109780205)
- Circlipstang inwendig (MB470-7 - 34960104)
- Circlipstang uitwendig (MB472-7 - 35020106)
- Universele waterpomptang (MB481-10T - 109420208)
- Schroevendraaier plat 0,5x3,0mm (MD920N - 177760402)
- Schroevendraaier plat 1,0x5,5mm (MD922N - 177761152)
- Schroevendraaier plat 1,2x6,5mm (MD932N - 177762002)
- Schroevendraaier PH2 (MD952N - 177771201)
- Schroevendraaier PZ2 (MD962N2 - 177780707)
- 6-delige doorslagenset (PPS06 - 69110104)
- 21-delige doppenset 1/2" 6-kant (T1221-6 - 167240209)
- 21-delige steekringsleutelset (6521 - 185830205)
- 11-delige steeksleutelset (6211 - 185810207)

Order nr.	728091085 
Orig. nr.	SDAL85
Aantal stuks	85
Type koffer	TC530
Gewicht	kg 21,00
Afmetingen (l x b x h)	mm 530 x 200 x 200
Prijs	€ 395,00

TENGOOLS

BESTSELLER



TOOLS

Teng Tools Service Case.

Assortiment van 9 TC trays gereedschap opgeslagen in de Teng Service Case bestaande uit:

- Doppen en accessoires 1/4"et 3/8" 4-22mm
- Tangen 4 st
- Schroevendraaiers plat 0.5x3.0 - 1.0x5.5 - 1.2x6.5, PH 0 - 1 - 2, PZ 2
- Sleutels HEX 1.5-10mm, 5/64"-3/8", TX 8-40
- Griptangen 5 st
- Set precisieschroevendraaiers en -tangen
- Steekringsleutels 8-19mm
- Bitsset met ratelhandvat 74 st

Order nr.	801200763	
Orig. nr.	SC09	
Aantal stuks	200	
Type koffer	TC-SC	
Gewicht	kg	19,00
Afmetingen (l x b x h)	mm	500 x 400 x 240
Prijs	€	549,00

Samenstellingslijst:

Orig. nr.	Order nr.	Lade	Omschrijving
TT1236	27560101	1	Steekringsleutels 8-19mm 12 stuks
TT1435	03490109	1	Doppenset 1/4" 4-13mm 35 st.
TT3819	03520103	1	Doppenset 3/8" 8-22mm 19st
TT440-T	109820101	2	4-delige tangenset
TT917N	174400101	2	7 schroevendraaiers plat, PH en PZ
TTHT28	128250107	2	Allensleutelset MM-AFTX 28 st
TTMI16	104450101	3	16-delige mini tangen-en schroevendraaierset
TTVG05	122480106	3	griptangenset 5 dlg.
TTMD74	144030103	3	74-delige bitsset met ratel

TENGOOLS

TOOLS



Teng Tools Service Case. Starter set voor techniekers.

Assortiment van 9 TC trays gereedschap opgeslagen in de Teng Service Case bestaande uit:

- Doppen en accessoires 1/4", 3/8" en 1/2" 4-32mm
- Tangen 4st
- Schroevendraaiers plat 0.5x3.0 - 1.0x5.5 - 1.2x6.5, PH 0 - 1 - 2, PZ 2
- Schroevendraaiers TX/TPX 8-30
- Zeskantsleutels op T-handvat 2.5-8mm
- Steekringsleutels 8-19mm

Order nr.	144290103 
Orig. nr.	SC01
Gewicht	kg 12,90
Afmetingen (l x b x h)	mm 500 x 400 x 240
Prijs	€ 499,00

Samenstellingslijst:

Orig. nr.	Order nr.	Lade	Omschrijving
TT1217	03570207	1	doppenset 15dlg. 1/2" 10-32mm
TT1236	27560101	1	Steekringsleutels 8-19mm 12 stuks
TT440-T	109820101	1	4-delige tangenset
TT917N	174400101	2	7 schroevendraaiers plat, PH en PZ
TT917TXN	174410100	2	Set van 7 TX/TPX schroevendraaiers.
TTHX7	68930106	2	7-delige metrische T-hendelset
TT1435	03490109	3	Doppenset 1/4" 4-13mm 35 st.
TT3819	03520103	3	Doppenset 3/8" 8-22mm 19st
TT1205	03570108	3	5-delige accessoiresset 1/2"

TENGOOLS



TOOLS

Teng Tools Service Case. Starter set voor technikers.

Assortiment van 6 TC trays gereedschap opgeslagen in de Teng Service Case bestaande uit:

- doppen en accessoires 1/4" en 3/8" 4-22mm
- tangenset 4st
- schroevendraaiers plat 0.5x3.0 - 1.0x5.5 - 1.2x6.5, PH 0 - 1 - 2, PZ 2
- Sleutels HEX 1.5-10mm, 5/64"-3/8", TX 8-40
- steekringsleutels 8-19mm

Order nr.		801200762
Orig. nr.		SC06
Gewicht	kg	16,00
Afmetingen (l x b x h)	mm	500 x 400 x 240
Prijs	€	419,00

Samenstellingslijst:

Orig. nr.	Order nr.	Lade	Omschrijving
TT1236	27560101	1	Steekringsleutels 8-19mm 12 stuks
TT1435	03490109	1	Doppenset 1/4" 4-13mm 35 st.
TT3819	03520103	1	Doppenset 3/8" 8-22mm 19st
TT440-T	109820101	2	4-delige tangenset
TT917N	174400101	2	7 schroevendraaiers plat, PH en PZ
TTHT28	128250107	2	Allensleutelset MM-AFTX 28 st

TENGOOLS



Teng Tools Service Tray.

Basisset service gereedschap geschikt voor de Teng Service Case TS-SC en de Teng opberg koffer TC-3. De set bestaat uit:

- griptang 235mm
- breekmes
- rolmeter 3m
- schroefleutel 4003
- zaagbeugel 300mm
- een bankhamer 500gr

Order nr.	144440104
Orig. nr.	SCPS01E
Gewicht	kg 1,90
Afmetingen (l x b x h)	mm 540 x 262 x 56
Prijs	€ 72,50

TENGOOLS



Gereedschapset 31-delig in handige pvc opbergkoffer TC-3

Order nr.	801001003
Orig. nr.	TC303
Gewicht	kg 1,00
Afmetingen (l x b x h)	mm 470 x 320 x 65
Prijs	€ 134,00

Samenstellingslijst:

Orig. nr.	Order nr.	Lade	Omschrijving
TT440-T	109820101	1	4-delige tangenset
TT6208	03900107	1	8-delige metrische steeksleutelset
TT3819	03520103	1	Doppenset 3/8" 8-22mm 19st

TENGOOLS



Gereedschapset 61-delig in handige pvc opbergkoffer TC-3

Order nr.	801001002
Orig. nr.	TC302
Gewicht	kg 1,00
Afmetingen (l x b x h)	mm 470 x 320 x 65
Prijs	€ 134,00

Samenstellingslijst:

Orig. nr.	Order nr.	Lade	Omschrijving
TT1435	03490109	1	Doppenset 1/4" 4-13mm 35 st.
TT6208	03900107	1	8-delige metrische steeksleutelset
TT12186	39180203	1	18-delige doppenset 1/2"

TENGOOLS



Gereedschapset in handige pvc opbergkoffer TC-3

Order nr.	801001001
Orig. nr.	TC301
Gewicht	kg 1,00
Afmetingen (l x b x h)	mm 470 x 320 x 65
Prijs	€ 119,00

Samenstellingslijst:

Orig. nr.	Order nr.	Lade	Omschrijving
TT1236	27560101	1	Steekringsleutels 8-19mm 12 stuks
TT917N	174400101	1	7 schroevendraaiers plat, PH en PZ
TT440-T	109820101	1	4-delige tangenset

TENGOOLS



Gereedschapsset 89-delig in handige pvc opbergkoffer TC-3

Order nr.	801001007		
Orig. nr.	TC307		
Gewicht	kg	1,00	
Afmetingen (l x b x h)	mm	470 x 320 x 65	
Prijs	€	134,00	

Samenstellingslijst:

Orig. nr.	Order nr.	Lade	Omschrijving
TT1435	03490109	1	Doppenset 1/4" 4-13mm 35 st.
TT3819	03520103	1	Doppenset 3/8" 8-22mm 19st
TBBS35	132150103	1	dop- en bitsset 1/4 35dlg

TENGOOLS



Gereedschapsset 90-delig in handige pvc opbergkoffer TC-3

Order nr.	801001005		
Orig. nr.	TC305		
Gewicht	kg	1,00	
Afmetingen (l x b x h)	mm	470 x 320 x 65	
Prijs	€	129,00	

Samenstellingslijst:

Orig. nr.	Order nr.	Lade	Omschrijving
TT1236	27560101	1	Steekringsleutels 8-19mm 12 stuks
TTMD74	144030103	1	74-delige bitsset met ratel
TT440-T	109820101	1	4-delige tangenset

TENGOOLS



Gereedschapsset 132-delig in handige pvc opbergkoffer TC-3

Order nr.	801001004		
Orig. nr.	TC304		
Gewicht	kg	1,00	
Afmetingen (l x b x h)	mm	470 x 320 x 65	
Prijs	€	109,00	

Samenstellingslijst:

Orig. nr.	Order nr.	Lade	Omschrijving
TTV907N	178710109	1	7dlg schroevendraaierset 1000V
TTV440	117490102	1	tangenset 1000V 4dlg
TTCP121	110380102	1	Kabelschoentang + kabelschoenen

TENGOOLS



Gereedschapsset 44-delig in handige pvc opbergkoffer TC-3

Order nr.	801001006		
Orig. nr.	TC306		
Gewicht	kg	1,00	
Afmetingen (l x b x h)	mm	470 x 320 x 65	
Prijs	€	129,00	

Samenstellingslijst:

Orig. nr.	Order nr.	Lade	Omschrijving
TT1236	27560101	1	Steekringsleutels 8-19mm 12 stuks
TT440-T	109820101	1	4-delige tangenset
TTHT28	128250107	1	Allensleutelset MM-AFTX 28 st

MINI MASTER TOOLSET 158 - 180 - 210



Inhoud
-1/4" 4-13mm
bits 1/4" : plat,
PH, PZ, TPX, Hex
-3/8" : 8-22mm
-1/2" + L. 125 &
250mm
-1/2" 10-32mm



Inhoud
-1/4" 4-13mm
bits 1/4" : plat,
PH, PZ, TPX, Hex
-3/8" : 8-22mm
-1/2" + L. 125 &
250mm
-1/2" 10-32mm



Inhoud
+Hex 1,5-10mm
Hex AF TX 8-40
-8-19mm
-6-22mm
-8-19mm

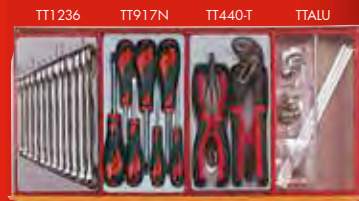

Inhoud
-8-19mm
-Tangen



Inhoud
-TX6 -45
-plat, PH, PZ



Inhoud
-Hex 1,5-10mm
Hex AF TX 8-40

SET
158

SET
210

SET
180



Inhoud
+Hex 2,5-8mm
-TX/TPX 10-40
-L175mm
-Tangen

Orig. nr.	Order nr.	158	180	210	Omschrijving
TT1435	03490109	✓	✓	✓	35-delige metrische doppenzet 1/4"
TT3819	03520103	✓	✓	✓	19-delige metrische doppenzet 3/8"
TT1205	03570108	✓	✓	✓	5-delige accessoiresset 1/2"
TT12176	03570256	✓	✓	✓	17-delige doppenzet 1/2" 6-kant
TTHT28	128250107	✓	✓	✓	28-delige hex en Tx-set
TT1236	27560101	✓	✓	✓	12-delige set met metrische steekringsleutels
TT6208	03900107	✓	✓	✓	8-delige metrische steeksleutelset
TT6508R	109730101	✓	✓	✓	8-delige ratel-steekringsleutel Tc-tray
TT917N	174400101			✓	7-delige schroevendraaierset
TT440-T	109820101			✓	4-delige tangenset
TTAU	03890100			✓	32-delige dop clip rail set
TTD912TXN	174380105	✓	✓	✓	12-delige schroevendr. TX-set
TTD914N	174370106	✓	✓	✓	14-delige schroevendr. Ph-ph-pz TTD-tray
TTNF12	128430105			✓	12-delige set naaldvrijen
TTD828	151440104			✓	28-delige borenset
TTMD12D	128650108			✓	12-delige set lange bitsen+handvat
TTHEX7	68930106		✓	✓	7-delige metrische T-hendelset
TTTX7	68920107		✓	✓	7-delige TX/TPX T-handvat torxset
TT474-7	04030102		✓	✓	4-delige circlipstang 7-175m
TT440-T	109820101		✓	✓	4-delige tangenset

SET
158

SET
180

SET
210

TC803SV

TC803N

TC806NO

TC804N

TCMM158803SV 801008569		
TCMM158803N 801008574		
TCMM158806NF 801008576		
		TC8211MX 801008211
TCMM158804N 801008572	TCMM180804N 801008578	
TCMM158804NS 801008575	TCMM180804NS 801008577	

TC806NF

TC804NS

TOOLS

PRIJS TOOLSET IS INCL. GEREEDSCHAPSKOFFER

TENGOOLS

Order nr.	Orig. nr.	Type koffer	Aantal stuks	Afmetingen (l x b x h) mm	Gewicht kg	Prijs €
801008569	TCMM158803SV	TC803SV	158	660x307x251	13,80	559,00
801008574	TCMM158803N	TC803N	158	660x305x250	13,80	599,00
801008576	TCMM158806NF	TC806NF	158	660x305x380	22,00	665,00
801008572	TCMM158804NS	TC804NS	158	660x305x380	21,00	655,00
801008575	TCMM158804N	TC804N	158	660x305x380	21,00	635,00
801008577	TCMM180804NS	TC804NS	180	660x305x380	21,00	769,00
801008578	TCMM180804N	TC804N	180	660x305x380	21,00	749,00
801008211	TC8211MX	TC806NO	210	660x305x380	39,00	739,00

MASTER STARTER TOOLSET 188



TT1435 TT3819 TT1205 TT12176

Inhoud
-1/4" 4-13mm
bits 1/4" :
Plat, PH, PZ,
TPX, Hex

-1/2" + L
125 & 250mm

-3/8" 8-22mm

-1/2" 10-
32mm

-1/2" 40-200
Nm

TTX1292

TTHT28 TT1236 TT6208 TT6508R

Inhoud
-Hex 1,5-10mm
Hex AF TX 8-40

-8-19mm

-6-22mm

-8-19mm

-20-32mm

TTX2032

TTD912TXN TTD914N

Inhoud
-TX 6-45
-Plat, PH, PZ

TTX00 + 710G

TTHEX7 TTTX7 TT474-7 TT440-T

Inhoud
-Hex 2,5-8mm
-TX/TPX 10-40
-L175mm
-Tangen

-L 250mm

TTXF05

**SET
188**

TENGITOOLSVOLLEDIG AANBOD
MASTER TOOLSETS
p. 81

188-delige Midi Master Toolset. Gereedschapset in gereedschapswagen, 3 laden gevuld, 188 delig. Starterset.

Bestaande uit:

- Gereedschapswagen met 7 lades TCW707EV
- Doppensets 1/4, 3/8, 1/2
- Momentsleutel
- Sleutels
- Allensleutels
- Schroevendraaiers
- Tangen
- Vijlen

Order nr.	801008532 ⓘ
Orig. nr.	TCMM188SV
Omschrijving	Master Toolset 188 in wagen TCW707EV
Type koffer	TCW707EV
Gewicht	kg 90,88
Prijs	€ 1.009,00

Samenstellingslijst:

Orig. nr.	Order nr.	Lade	Omschrijving
TT1435	03490109	1	Doppenset 1/4" 4-13mm 35 st
TT3819	03520103	1	Doppenset 3/8" 8-22mm 19st
TT1205	03570108	1	5-delige accessoiresset 1/2"
TT12176	03570256	1	Set van 17 MM-doppen 1/2inch 6-kant
TTX1292	73190100	1	momentsleutel 1/2 40-210Nm
TTHT28	128250107	2	Allensleutelset MM-AF-TX 28 st
TT1236	27560101	2	Steekringsleutels 8-19mm 12 stuks
TT6208	03900107	2	8-delige metrische steeksleutelset
TT6508R	109730101	2	ratel-steekringsleutel Tc-tray 8dlg
TTX2032	68910108	2	7-delige metrische steeksleutelset
TTX00	101030203	3	ledige TX-tray lang model
TTD912TXN	174380105	3	schroevendr. TX-set 12 dlg
TTD914N	174370106	3	schroevendr. Pl-ph-pz TTD-tray 14 dlg
TTHEX7	68930106	4	7-delige metrische T-hendelset
TTTX7	68920107	4	7-delige TX/TPX T-handvat torxsset
TT474-7	04030102	4	circlipstang 4dlg. 7-175m
TT440-T	109820101	4	4-delige tangenset
TTXF05	128440104	4	5-delige vijlenset

MASTER TOOLSET 491



TT1435 TT3819 TT1205 TT12176

Inhoud
-1/4" 4-13mm
bits 1/4": Plat,
PH, PZ, TPX, Hex
-1/2" + L. 125
& 250mm
-3/8" 8-22mm
-1/2" 10-32mm
-1/2" 40-200
Nm

TTX1292



TTHEX7 TTX7 TT474-7 TT440-T

Inhoud
-Hex 2,5-8mm
-TX/TPX 10-40
-L175mm
-Tangen
-L 250mm

TTXF05



TTHT28 TT1236 TT6208 TT6508R

Inhoud
-Hex 1,5-
10mm
Hex AF TX
8-40
-8-19mm
-6-22mm
-8-19mm
-20-32mm

TTX2032



TTPS09E

Inhoud
-servicetray

TTX00

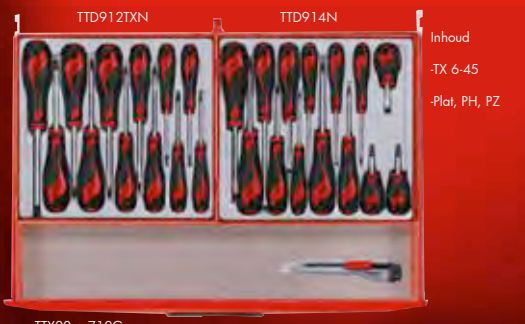

TTD912TXN TTD914N

Inhoud
-TX 6-45
-Plat, PH, PZ

TTX00 + 710G



TTD021299 TTMD74 TTTM03

Inhoud
-299pcs
-bits plat, PH,
PZ, Hex, TX,
TPX, SQ
-inspectie
-AWG 10-22,
DIN 0.5 -
6mm²

VES1000

SET
491

VOLLEDIG AANBOD
MASTER TOOLSETS

p. 81

BESTSELLER

TENGTOOLS

De 491-delige Midi Master Toolset. De populairste Teng Tools basis toolset bestaat uit een samenstelling van 491 tools in het unieke Teng Tray systeem, opgeslagen in een gereedschapswagen.

Deze set bevat:

- doppen en accessoires 1/4", 3/8" en 1/2"
- momentsleutel 1/2"
- rolmeter
- beugelzaag
- breekmes
- schroefleutel
- meetlat
- schroevendraaiers
- bitssets met handvat
- allensleutels
- tangen
- kabelkrimptang met kabelschoenen
- steek- en steekringsleutels
- circlipstangen
- griptang
- Tx- en Hex T-sleutels
- inspectieset
- vijlenset

Order nr.	122400104 ⓘ
Orig. nr.	TCMM491NE
Aantal stuks	490
Type koffer	TCW807N
Gewicht	105,80 kg
Prijs	€ 1.399,00

Samenstellingslijst:

Orig. nr.	Order nr.	Lade	Omschrijving
TT1435	03490109	1	Doppenset 1/4" 4-13mm 35 st.
TT3819	03520103	1	Doppenset 3/8" 8-22mm 19st
TT1205	03570108	1	5-delige accessoiresset 1/2"
TT12176	03570256	1	Set van 17 MM-doppen 1/2inch 6-kant
TTX1292	73190100	1	momentsleutel 1/2 40-210Nm
TTHT28	128250107	2	Allensleutelset MM-AF-TX 28 st
TT1236	27560101	2	Steekringsleutels 8-19mm 12 stuks
TT6208	03900107	2	8-delige metrische steeksleutelset
TT6508R	109730101	2	ratel-steekringsleutel Tc-tray 8dlg
TTX2032	68910108	2	7-delige metrische steeksleutelset
TTD912TXN	174380105	3	schroevendr. TX-set 12 dlg
TTD914N	174370106	3	schroevendr. Pl-ph-pz TTD-tray 14 dlg
710G	177710308	3	breekmes
TTHEX7	68930106	4	7-delige metrische T-hendelset
TTTX7	68920107	4	7-delige TX/TPX T-handvat torxset
TT474-7	04030102	4	circlipstang 4dlg. 7-175m
TT440-T	109820101	4	4-delige tangenset
TTXF05	128440104	4	5-delige vijlenset
TTPS09E	117060103	5	9-delige basis-tools set (DIN1041-hamer)
TTX00	101030203	5	ledige TX-tray lang model
TTD021299	161800310	6	299-delig assortiment van de meest gangbare geïsoleerde kabelschoenen
TTMD74	144030103	6	74-delige bitsset met ratel
TTTM03	109460105	6	inspectieset Tc-tray 3dlg
VES1000	100072188	6	kabelschoenkrimptang

MEGA MASTER TOOLSET 1001



Deze 1001-delige Mega Master Tools Set bestaat uit een samenstelling van 1168 tools in het unieke Teng Tray systeem, alles opgeslagen in een stack van de TCW810N wagen, TC803N tussenkoffer en de TC806NF topkoffer.



TT1435 TT3819 TT1205 TT12176
Inhoud
-1/4" 4-13mm
bits 1/4" : Plat,
PH, PZ, TPX, Hex
-1/2" + L 125 &
250mm
-3/8" 8.22mm
-1/2" 10.32mm
-1/2" 40.200 Nm

TTX1292



TTH28 TT1236 TT6208 TT6508R
Inhoud
Hex 1.5-10mm
Hex AF TX 8-40
-8-19mm
-6.22mm
-8-19mm
-20-32mm

TTX2032



TTD912TXN ITD914N
Inhoud
-TX 6-45
-Plat, PH, PZ

TTX00 + 710G

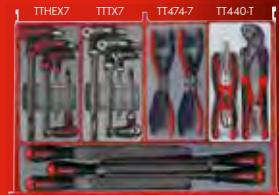

TTHEX7 TTX7 TT474-7 TT440-T
Inhoud
-Hex 2,5-8mm
-TX/TPX 10-40
-L175mm
-Tangen
-L 250mm

TTXF05



TTFS09E

Inhoud
-servicetray

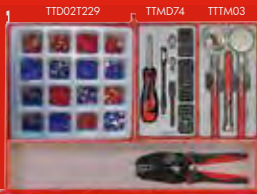

TTD02T229 TTMD74 TTIM03
Inhoud
299pcs
-bits plat, PH,
PZ, Hex, TX,
TPX, SQ
-inspectie
-AWG 10-22,
DIN 0.5 - 6mm²

TTX00 + VES1000



TTPC09 TTID20 TTMD12D TTV907N
Inhoud
-3-8mm
-Plat, PH,
Hex, TX
-Plat, PH, PZ,
TX, Hex
-Plat, PH, PZ

TTX01

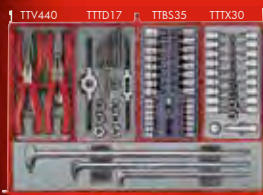

TTV440

TTD17

TTBS35

TTX30

Inhoud
-L150/175mm
-M3-M12
-1/4" plat, PH,
PZ, TX
-3/8" hex mm/inch
-1/4" E4-E8
-3/8" E10-E18
-3/8" TX, 10-40
plat PH PZ
-L300-400-500mm

TTXP83



TTB04 TT9116 TTHEX23 TTNF12
Inhoud
-cap. 100mm x
130mm
-1/2" 13-24mm
-Hex 5-19mm
L 40 & 75mm
-L163mm
-6-32mm

TTX6311

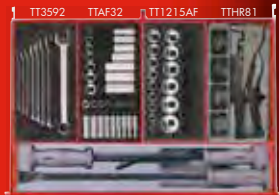

TT3592 TTAF32 TT1215AF TTHR81
Inhoud
-5/16"-3/4"
-1/4" : 3/16"
-1/2"
-3/8" : 3/8"
-3/4"
-1/2" : 3/8" - 1
1/4"
-2,4-4,8mm
-L300-450-550mm

TTXP83A



TTD02

TTRS15

TTVG05

Inhoud
-1/2" Hex
71.2mm & Tx
20-60

TTHC03

TTHP08

TTMI16

TTNR81

Inhoud
-Ø 1/4, 3/4,
1/4, 1/4, 3/4
-2 1/4
-19.50, 30.75,
50-120
-plat, PH, TX,
125mm
-cap. M3 - M6

TTX03

TTX08

TTX16

TTX81



TTXEXT13
Inhoud
-1/4" 3/8"
1/2"
-5-12mm

TTXMDN



TTALU TTK40 TT6010M TT6506
Inhoud
-clips 1/4, 3/8,
1/2
-L125mm
-10-19mm
-8x9 - 18x19mm

TTX3404

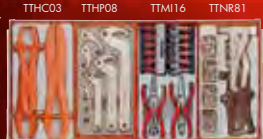

TTX03

TTX08

TTX16

TTX81



TTOS16 TTSN11 TTR04 TTX23
Inhoud
-carter :
5/16"x3/8",
11-14mm,
bougie 3/8"
168.21mm
-7/64"-19/6,
extract. 6-12
-TX 20-55mm
L 40 & 75mm

TTX03

TTX08

TTX16

TTX81

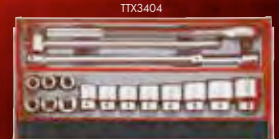

TTX3404
Inhoud
-3/4 + 2
verlengstukken
200 & 400mm
-3/4" 19.50mm

TTX3414

SET
1001

TENGOOLS

BESTSELLER

Order nr.	122390107 
Orig. nr.	TCMM1001NE
Aantal stuks	1168
Type koffer	TCW810N+TC803N+TC806NF
Gewicht	161,79
Afmetingen (l x b x h)	460 x 670 x 950
Prijs	€ 3.195,00

Samenstellingslijst:

Orig. nr.	Order nr.	Lade	Omschrijving
TTD02	161800305	1	ledige DTC-tray met 16-vak verdeling
TTRS15	143880102	1	set dopbitsen Ribe en Spline - 15dlg
TTVG05	122480106	1	griptangenset 5 dlg
TTXEXT13	68870104	2	13-delige verlengstukkenset
TTXMDN	114590102	2	schroevendraaiers op dop 9dlg. 5-13mm
TTALU	03890100	3	32-delige dop clip rail set
TTK40	174480103	3	5-delige messenset
TT6010M	109470104	3	10-delige steekringsleutels kort
TT6506	73000101	3	6-delige kniesleutelset
TTHC03	118420108	4	3-delige slanglemtangenset
TTHP08	102120102	4	8-delige haak- en pinsleutelset
TTMI16	104450101	4	16-delige mini tangen-en schroevendraaierset
TTNR81	106190101	4	81-delige blindnietmoerenset
TTOS16	03960101	5	16-delige olie service set
TTSN11	69340107	5	11-delige extractorset
TTSR04	117690107	5	4-delige schraper- en verwijderset
TTTX23	68860105	5	bitsen Tx-Tc 23dlg. 40 - 75mm 20 70Tx
TTX3404	101530103	6	4-delige set dopaccessoires met 3/4" aansluiting
TTX3414	101540102	6	14-delige doppenset met 3/4" aansluiting metrisch
TT1435	03490109	7	Doppenset 1/4" 4-13mm 35 st.
TT3819	03520103	7	Doppenset 3/8" 8-22mm 19st
TT1205	03570108	7	5-delige accessoiresset 1/2"
TT12176	03570256	7	Set van 17 MM-doppen 1/2inch 6-kant
TTX1292	73190100	7	momentsleutel 1/2 40-210Nm
TTHT28	128250107	8	Allensleutelset MM-AFTX 28 st
TT1236	27560101	8	Steekringsleutels 8-19mm 12 stuks
TT6208	03900107	8	8-delige metrische steeksleutelset
TT6508R	109730101	8	ratel-steekringsleutel Tc-tray 8dlg
TTX2032	68910108	8	7-delige metrische steeksleutelset
TTX00	101030203	9	ledige TX-tray lang model
TTD912TXN	174380105	9	schroevendr. TX-set 12 dlg
TTD914N	174370106	9	schroevendr. Ph-ph-pz TTD-tray 14 dlg
710G	177710308	9	breekmes
TTHEX7	68930106	10	7-delige metrische T-hendelset
TTTX7	68920107	10	7-delige TX/TPX T-handvat torxset
TT474-7	04030102	10	circlipstang 4dlg. 7-175m
TT440-T	109820101	10	4-delige tangenset
TTXF05	128440104	10	5-delige vijlenset
TTPS09E	117060103	11	9-delige basis-tools set (DIN1041-hamer)
TTD02T299	161800310	12	299-delig assortiment van de meest gangbare geïsoleerde kabelschoenen
TTMD74	144030103	12	74-delige bitsset met ratel
TTTM03	109460105	12	inspectieset Tc-tray 3dlg
VES1000	100072188	12	kabelschoenkrimptang
TTPC09	69220101	13	beitel- en doorslagset Tc-tray 9dlg
TTID20	102100104	13	slagschroevendr. set 1/2 20dlg
TTMD12D	128650108	13	set lange bitsen+handv. 12dlg
TTV907N	178710109	13	7dlg schroevendraaierset 1000V
TTX01	109450106	13	ledige TX-tray met 6-vak verdeling
TTV440	117490102	14	tangenset 1000V 4dlg
TTTD17	69190106	14	tappen- en snijkussenset 17dlg
TTBS35	132150103	14	dop- en bitsset 1/4 35dlg
TTTX30	102140100	14	torx set 1/4-3/8 Tx,TPX,Tx-E 30dlg
TTXPB3	100690106	14	koevoelset 300-400-500mm 3dlg
TT804	03980109	15	poulietrekkereset 4dlg
TT9116	68800101	15	slagdoppen 1/2" 6-kant
TTHEX23	68850106	15	bitsen Hex 23dlg
TTNF12	128430105	15	set naaldvijlen 12dlg
TTX6311	68910157	15	ringsleutels Tx-tray 6-32mm 11dlg
TT3592	58050303	16	steekringsleutels AF 8 dlg
TTAF32	68610104	16	doppenset 32dlg. AF
TTHR81	69210102	16	riveteerset Tc-tray 81dlg
TTXPB3A	117860106	16	barensset universeel 3dlg
TT1215AF	03570306	16	AF-set 15 doppen 1/2" 12kant

TOOLS

MEGA MASTER TOOLSET 1030



Deze 1030-delige Mega Master Tools Set bestaat uit een samenstelling van 1030 tools in het unieke Teng Tray systeem, alles opgeslagen in een stack van de TCW807EV wagen, TC803SV tussenkoffer en de TC806SV topkoffer.

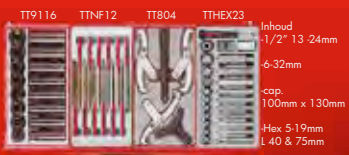
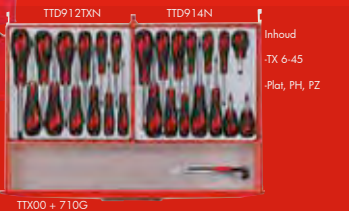
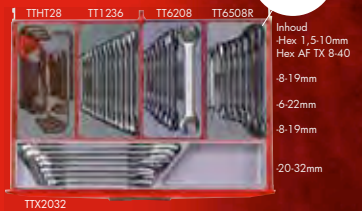
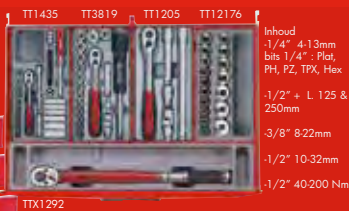

SET
1030

NEW

TENGOOLS

Order nr.	122390113 	
Orig. nr.	TCMM2001EV	
Gewicht	kg	165,00
Prijs	€	2.489,00

Samenstellingslijst:

Orig. nr.	Order nr.	Lade	Omschrijving
TT1205	03570108	1	5-delige accessoiresset 1/2"
TT12176	03570256	1	Set van 17 MM-doppen 1/2inch 6-kant
TT1435	03490109	1	Doppenset 1/4" 4-13mm 35 st
TT3819	03520103	1	Doppenset 3/8" 8-22mm 19st
TTX1292	73190100	1	momentsleutel 1/2 40-210Nm
TT1236	27560101	2	Steekringsleutels 8-19mm 12 stuks
TT6208	03900107	2	8-delige metrische steeksleutelset
TT6508RS	166720102	2	Ratel-steekringsleutelset 8dlg
TTHT28	128250107	2	Allensleutelset MM-AF-TX 28 st
TTX2032	68910108	2	7-delige metrische steeksleutelset
710G	177710308	3	breekmes
TTD912TXN	174380105	3	schroevendr. TXset 12 dlg
TTD914N	174370106	3	schroevendr. Pl-ph-pz TTD-tray 14 dlg
TTX00	101030203	3	ledige TX-tray lang model
TT440-T	109820101	4	4-delige tangenset
TT474-7	04030102	4	circulspang 4dlg, 7-175m
TTHEX7	68930106	4	7-delige metrische T-hendelset
TTTX7	68920107	4	7-delige TX/TPX T-handvat torxset
TTXF05	128440104	4	5-delige vijlenset
TTPS09E	117060103	4	9-delige basis-tools set (DIN1041-hamer)
TTXPB3	100690106	5	koevoelset 300-400-500mm 3dlg
TTD02T299	161800310	6	299-delig assortiment van de meest gangbare geïsoleerde kabelschoenen
TTMD74	144030103	6	74-delige bitset met ratel
TTTM03	109460105	6	inspectieset Tc-tray 3dlg
VES1000	100072188	6	kabelschoenkrimptang
TTID20	102100104	7	slagschroevendr. set 1/2 20dlg
TTMD12D	128650108	7	set lange biten+handv. 12dlg
TTPC09	69220101	7	beitel- en doorslagset Tc-tray 9dlg
TTV907N	178710109	7	7dlg schroevendraaierset 1000V
TTX01	109450106	7	ledige TX-tray met 6-vak verdeling
TTD17	69190106	8	tappen- en snijkussenset 17dlg
TTV440	117490102	8	tangenset 1000V 4dlg
TTHR81	69210102	8	riveteerset Tc-tray 81dlg
TT00	04160107	8	299-delig assortiment van de meest gangbare geïsoleerde kabelschoenen
TTB04	03980109	9	poulietrekkrisset 4dlg
TT9116	68800101	9	slagdoppen 1/2" 6-kant
TTHEX23	68850106	9	biten Hex 23dlg
TTNF12	128430105	9	set naaldvijlen 12dlg
TT1215AF	03570306	10	AF-set 15 doppen 1/2 12kant
TT3592	58050303	10	steekringsleutels AF 8 dlg
TTAF32	68610104	10	doppenset 32dlg, AF
TTVG05	122480106	10	griptangenset 5 dlg
TTBS35	132150103	11	dop- en bitsset 1/4 35dlg
TTTXH15	118890102	11	15-delige bitsdoppenset met 1/2" aansluiting 100mm lang
TTX23	68860105	11	biten Tx-Tc 23dlg, 40 - 75mm 20 70Tx
TTX30	102140100	11	torx set 1/4-3/8 Tx,TPX,Tx-E 30dlg
TTHP08	102120102	12	8-delige haak- en pinsleutelset
TTMI16	104450101	12	16-delige mini tangen-en schroevendraaierset
TTALU	03890100	12	32-delige dop clip rail set
TTHC03	118420108	12	3-delige slangklemtangenset
TTXEXT13	68870104	13	13-delige verlengstukenset
TTXPB3A	117860106	13	barenset universeel 3dlg

TOOLS

MASTER TOOLSET 188 - 215 - 491 - 632 - 721 - 926



Inhoud
-1/4" 4-13mm
bits/emb. 1/4"
: Plat, PH, PZ,
TPX, Hex
-1/2" + L 125
& 250mm
-3/8" 8-22mm
-1/2" 10-32mm
-1/2" 40-200
Nm

TTX1292

+

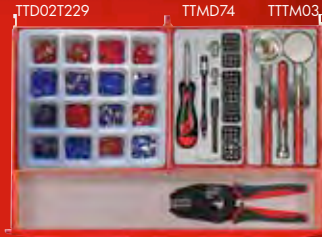

Inhoud
-299pcs
-bits/emb. plat,
PH, PZ, Hex, TX,
TPX, SQ
-inspectie/
inspection
-AWG 10-22,
DIN 0.5 - 6mm²

**SET
491**

VES1000 + TTX00

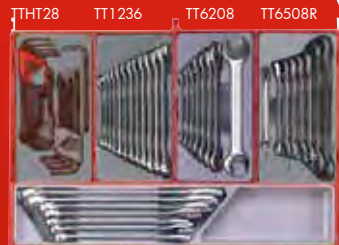

Inhoud
-Hex 1, 5-10mm
Hex AF TX 8-40
-8-19mm
-6-22mm
-8-19mm
-20-32mm

TTX2032

+

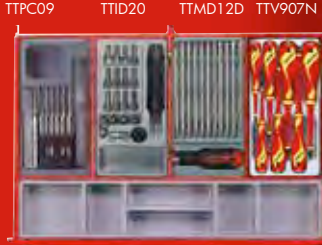

Inhoud
-3-8mm
-Plat, PH, Hex, TX
-Plat, PH, PZ,
TX, Hex
-Plat, PH, PZ

**SET
632**

TTX01

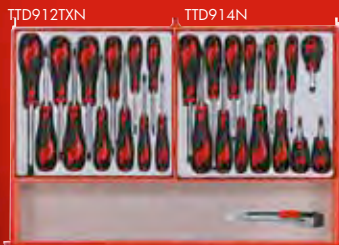

Inhoud
-TX 6-45
-Plat, PH, PZ

TTX00 + 710G

+

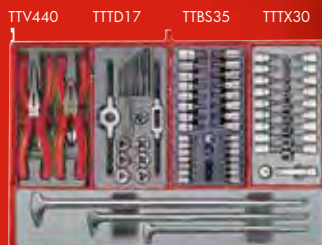

Inhoud
-L150/175mm
-M3-M12
-1/4" plat, PH,
PZ, TX
3/8" hex mm/
inch
-1/4" E4-E8
3/8" E10-E18
3/8" TX, 10-40
plat PH PZ
-L300-400-
500mm

**SET
721**

TTXPB3

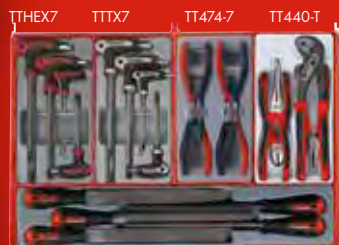

Inhoud
-Hex 2,5-8mm
-TX/TPX 10-40
-L175mm
-Tangen/pinces
-L 250mm

TTXF05

+

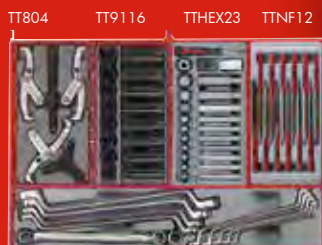

Inhoud
-cap. 100mm x
130mm
-1/2" 13-24mm
-Hex 5-19mm
L 40 & 75mm
-L163mm
-6-32mm

**SET
188**

TTX6311



Inhoud
-servicetray

TTX00

+

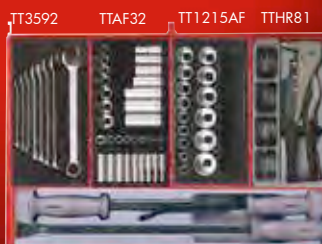

Inhoud
-5/16"-3/4"
-1/4" : 3/16"
-1/2" : 3/8"
3/8" : 3/8"
-3/4"
-1/2" : 3/8" - 1
1/4"
-2,4-4,8mm
-L300-450-550mm

**SET
926**

TTXPB3A

**SET
188**

**SET
215**

SET 188	SET 215	SET 491	SET 632	SET 721	SET 926
<p>SET p. 72</p> <p>TCMM188SV 801008532</p>	<p>TCMM215SV 801008540</p>	<p>TCMM491SV 801200742</p>	<p>TCMM632SV 801008556</p>	+	 <p>TCW707EV</p>
<p>TCMM188N 801008529</p>	<p>TCMM215N 801008537</p>	<p>SET p. 74</p> <p>TCMM491NE 122400104</p>	<p>TCMM632N 801008553</p>	+	 <p>TCW807N</p>
<p>TCMM188NW 801008613</p>	<p>TCMM215NW 801008615</p>	<p>TCMM491NW 801008614</p>	<p>TCMM632NW 801008616</p>	+	 <p>TCW807NW</p>
<p>TCMM188NS 801008531</p>	<p>TCMM215NS 801008539</p>	<p>TCMM491NS 801200746</p>	<p>TCMM632NS 801008555</p>	+	 <p>TCW807NS</p>
<p>TCMM188X 801008657</p>	<p>TCMM215X 801008659</p>	<p>TCMM491X 801008658</p>	<p>TCMM632X 801008660</p>	+	 <p>TCW907X</p>
 <p>TCW808N</p>			<p>TCMM632808N 801008557</p>	+	<p>TCMM721808N 801008560</p>
 <p>TCW810N</p>			<p>TCMM632810N 801008558</p>	+	<p>TCMM721810N 801008561</p>
 <p>TCW806LN</p>				+	<p>TCMM926810N 801008565</p>
 <p>TCW809N</p>				+	<p>TCMM721806N 801008563</p>
				+	<p>TCMM926806N 801008567</p>
				+	<p>TCMM721809N 801008564</p>
				+	<p>TCMM926809N 801008568</p>

TOOLS

PRIJS TOOLSET IS INCL. GEREEDSCHAPSWAGEN

PRIJZEN EN SAMENSTELLINGSLIJST

p. 82

TENGOOLS

Order nr.	Orig. nr.	Type wagen	Aantal stuks	Prijs €
801008532	TCMM188SV	TCW807SV	188	1.009,00
801008529	TCMM188NE	TCW807N	188	1.099,00
801008657	TCMM188X	TCW907X	188	1.419,00
801008531	TCMM188NS	TCW807NS	188	1.129,00
801008613	TCMM188NW	TCW807NW	188	1.129,00
801008540	TCMM215SV	TCW807SV	215	1.189,00
801008537	TCMM215N	TCW807N	215	1.269,00
801008659	TCMM215X	TCW907X	215	1.525,00
801008539	TCMM215NS	TCW807NS	215	1.289,00
801008615	TCMM215NW	TCW807NW	215	1.289,00
801200742	TCMM491SV	TCW807SV	491	1.329,00
122400104	TCMM491NE	TCW807N	491	1.399,00
801008658	TCMM491X	TCW907X	491	1.669,00
801200746	TCMM491NS	TCW807NS	491	1.425,00
801008614	TCMM491NW	TCW807NW	491	1.425,00
801008556	TCMM632SV	TCW807SV	632	1.379,00
801008553	TCMM632N	TCW807N	632	1.459,00
801008660	TCMM632X	TCW907X	632	1.749,00
801008555	TCMM632NS	TCW807NS	632	1.479,00
801008557	TCMM632808N	TCW808N	632	1.499,00
801008558	TCMM632810N	TCW810N	632	1.539,00
801008616	TCMM632NW	TCW807NW	632	1.479,00
801008560	TCMM721808N	TCW808N	721	1.669,00
801008561	TCMM721810N	TCW810N	721	1.709,00
801008563	TCMM721806N	TCW806LN	721	2.335,00
801008564	TCMM721809N	TCW809N	721	2.389,00
801008565	TCMM926810N	TCW810N	926	2.039,00
801008567	TCMM926806LN	TCW806LN	926	2.675,00
801008568	TCMM926809N	TCW809N	926	2.709,00

Orig. nr.	Order nr.	Lade	188	215	491	632	721	926	Omschrijving
TT1435	03490109	1	✓	✓	✓	✓	✓	✓	35-delige metrische doppenset 1/4"
TT3819	03520103	1	✓	✓	✓	✓	✓	✓	19-delige metrische doppenset 3/8"
TT1205	03570108	1	✓	✓	✓	✓	✓	✓	5-delige doppenset accessoires 1/2"
TT12176	03570256	1	✓	✓	✓	✓	✓	✓	17-delige metrische doppenset 1/2" 6-kant
TTX1292	73190100	1	✓	✓	✓	✓	✓	✓	Momentsleutel 1/2 40-210Nm
TTHT28	128250107	2	✓	✓	✓	✓	✓	✓	28-delige hex & Tx-set
TT1236	27560101	2	✓	✓	✓	✓	✓	✓	12-delige set met metrische steekringsleutels
TT6208	03900107	2	✓	✓	✓	✓	✓	✓	8-delige metrische steeksleutelset
TT6508R	109730101	2	✓	✓	✓	✓	✓	✓	8-delige ratel-steekringsleutel Tc-tray
TTX2032	68910108	2	✓	✓	✓	✓	✓	✓	7-delige metrische steeksleutelset
TTX00	101030203	3	✓	✓	✓	✓	✓	✓	Ledige TX-tray lang model
TTD912TXN	174380105	3	✓	✓	✓	✓	✓	✓	12-delige schroevendr. TX-set
TTD914N	174370106	3	✓	✓	✓	✓	✓	✓	14-delige schroevendr. Pl-ph-pz TTD-tray
710G	177710308	3	✓	✓	✓	✓	✓	✓	Breekmes
TTHEX7	68930106	4	✓	✓	✓	✓	✓	✓	7-delige metrische T-hendelset
TTTX7	68920107	4	✓	✓	✓	✓	✓	✓	7-delige TX/TPX T-handvat torxset
TT474-7	04030102	4	✓	✓	✓	✓	✓	✓	4-delige circlipstangenset
TT440-T	109820101	4	✓	✓	✓	✓	✓	✓	4-delige tangenset
TTXF05	128440104	4	✓	✓	✓	✓	✓	✓	5-delige vijlenset
TTPS09E	117060103	5	✓	✓	✓	✓	✓	✓	9-delige basis-tools set (DIN1041-hamer)
TTX00	101030203	5	✓	✓	✓	✓	✓	✓	Ledige TX-tray lang model
TTD02T299	161800310	6	✓	✓	✓	✓	✓	✓	299-delig assortiment geïsoleerde kabelschoenen
TTMD74	144030103	6	✓	✓	✓	✓	✓	✓	74-delige bitset met ratel
TTTM03	109460105	6	✓	✓	✓	✓	✓	✓	3-delige inspectieset Tc-tray
VES1000	100072188	6	✓	✓	✓	✓	✓	✓	Kabelschoenkrimp tang
TTX00	101030203	6	✓	✓	✓	✓	✓	✓	Ledige TX-tray lang model
TTPC09	69220101	7	✓	✓	✓	✓	✓	✓	9-delige beitel- en doorslagset Tc-tray
TTID20	102100104	7	✓	✓	✓	✓	✓	✓	20-delige slagschroevendr. set 1/2
TTMD12D	128650108	7	✓	✓	✓	✓	✓	✓	12-delige set lange bitsen+handv.
TTV907N	178710109	7	✓	✓	✓	✓	✓	✓	7-delige schroevendraaierset 1000V
TTX01	109450106	7	✓	✓	✓	✓	✓	✓	Ledige TX-tray met 6-vak verdeling
TTV440	117490102	8	✓	✓	✓	✓	✓	✓	4-delige tangenset 1000V
TTD17	69190106	8	✓	✓	✓	✓	✓	✓	17-delige tappen- en snijkussenset
TIBS35	132150103	8	✓	✓	✓	✓	✓	✓	35-delige dop- en bitset 1/4
TTTX30	102140100	8	✓	✓	✓	✓	✓	✓	30-delige torx set 1/4-3/8 Tx, TPX, Tx-E
TTXPB3	100690106	8	✓	✓	✓	✓	✓	✓	3-delige koevoetset 300-400-500mm
TTB04	03980109	9	✓	✓	✓	✓	✓	✓	4-delige poulietrekset
TT9116	68800101	9	✓	✓	✓	✓	✓	✓	Slagdoppen 1/2" 6-kant
TTHEX23	68850106	9	✓	✓	✓	✓	✓	✓	23-delige bitsen Hex
TTNF12	128430105	9	✓	✓	✓	✓	✓	✓	12-delige set naaldvijlen
TTX6311	68910157	9	✓	✓	✓	✓	✓	✓	11-delige ringsleutels Tx-tray 6-32mm
TT3592	58050303	10	✓	✓	✓	✓	✓	✓	8-delige steekringsleutels AF 8
TTAF32	68610104	10	✓	✓	✓	✓	✓	✓	32-delige doppenset AF
TT1215AF	03570306	10	✓	✓	✓	✓	✓	✓	15-delige doppenset 1/2" AF
TTHR81	69210102	10	✓	✓	✓	✓	✓	✓	81-delige riveteerset Tc-tray
TTXPB3A	117860106	10	✓	✓	✓	✓	✓	✓	3-delige barenset universeel

HD MASTER MOTOR TOOLSET 445

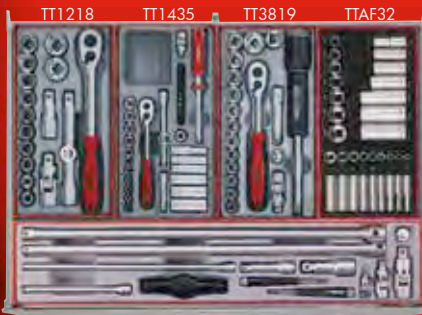

TT1218 TT1435 TT3819 TTA32

- Inhoud
- 1/4" 4-13mm bits 1/4": Plat, PH, PZ, TPX, Hex
 - 3/8": 8-22mm
 - 1/2": 10-24mm
 - 1/4" : 3/16"
 - 1/2" 3/8" : 3/8" - 3/4"
 - 1/4", 3/8", 1/2"

TTXEXT13



TT440 TT474-7 TT1236 TT3592

- Inhoud
- Tangen
 - Circclipstangen
 - 8-19mm
 - 5/16"-3/4"
 - 13/15" 1 1/4"

TTX2640

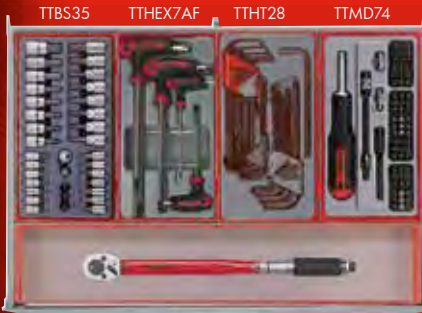

TTBS35 TTHEX7AF TTHT28 TTMD74

- Inhoud
- 1/4" plat, PH, PZ, TX
 - 3/8" hex mm/ inch
 - Hex 3/32"-5/16"
 - Hex 1,5-10mm & 5/54" - 3/8", Tx 8-40
 - Bits plat, PH, PZ, Hex, TX, TPX, SQ
 - 3/8" 20-110Nm

TTX00 + 3892AF-E3

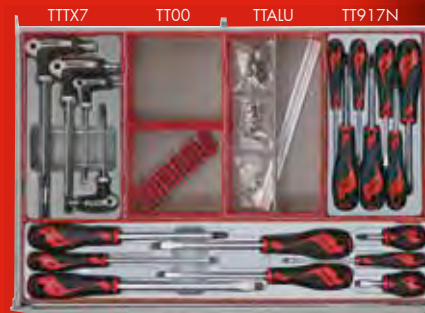

TTX7 TT00 TTALU TT917N

- Inhoud
- TX/TPX 10-40
 - 3x10 clips 1/4", 3/8", 1/2"
 - Plat, PH, PZ
 - Plat, PH

TTX918N



TTPS09E

- Inhoud
- Service tray
 - Schraeper
 - Slagkop 1/2"
 - Steekring-sleutel/30mm

TTX00 + MDSCR + 920230 + 600536 + 710G



TTID20 TTPO9 TT1215AF TTSN11

- Inhoud
- Plat, PH, Hex, TX
 - 3-8mm
 - 1/2" : 3/8"
 - 1 1/4"
 - 7/64
 - 19/6, extract. 6-12
 - L. 300-400 & 500mm

TTXPB3

SET
445

**VOLLEDIG AANBOD
MASTER MOTOR TOOLSETS**

p. 86

BESTSELLER**TENGOOLS**

445 delige motorset in een grijze 7-lade kar. Geschikt voor iedere motor specialist.

Order nr.	801008600 ⓘ		
Orig. nr.	TCHD445NS		
Omschrijving	Master Toolset 445 in wagen TCW807NS		
Aantal stuks	445		
Gewicht	kg	98,50	
Afmetingen (l x b x h)	mm	670 x 460 x 950	
Prijs	€	1.599,00	

Samenstellingslijst:

Orig. nr.	Order nr.	Lade	Omschrijving
TT1218	39180104	1	18-delige doppenet 1/2"
TT1435	03490109	1	Doppenset 1/4" 4-13mm 35 st
TT3819	03520103	1	Doppenset 3/8" 8-22mm 19st
TTAF32	68610104	1	doppenset 32dlg. AF
TTXEXT13	68870104	1	13-delige verlengstukkenet
TT440	44280105	2	4-delige tangenset
TT474-7	04030102	2	circlipstang 4dlg. 7-175mm
TT1236	27560101	2	Steekringsleutels 8-19mm 12 stuks
TT3592	58050303	2	steekringsleutels AF 8 dlg
TTX2640	68910207	2	Set van 7 steekringsleutels gaande van 13/15inch tot 1 1/4inch.
TTBS35	132150103	3	dop- en bitsset 1/4 35dlg
TTHEX7AF	68930205	3	Set van 7 allensleutels met T-hendel
TTHT28	128250107	3	Allensleutelset MM-AF-TX 28 st
TTMD74	144030103	3	74-delige bitsset met ratel
3892AG-E3	73190076	3	Momentsleutel
TTTX7	68920107	4	7-delige TX/TPX T-handvat torxset
TT00	04160107	4	299-delig assortiment van de meest gangbare geïsoleerde kabelschoenen
TTALU	03890100	4	32-delige dop clip rail set
TT917N	174400101	4	7 schroevendraaiers plat, PH en PZ
TTX918N	174500108	4	5-delige schroevendraaierset plat en PH waarvan 2 stubby
TTPS09E	117060103	5	9-delige basis-tools set (DIN1041-hamer)
MD-SCR	03130101	5	pakkingschraper 24mm x 245mm
920230	114872807	5	Slagdop 1/2" 6-kant. Maat: 15/16"
600536	72672702	5	Steekringsleutel 36mm. Identieke maten aan beide uiteinden.
TTX00	101030203	5	ledige TX-tray lang model
TTID20	102100104	6	slagschroevendr. set 1/2 20dlg
TTPC09	69220101	6	beitel- en doorslagset Tctray 9dlg
TT1215AF	03570306	6	De AF-set bestaat uit 15 doppen 1/2" 12-kant
TTSN11	69340107	6	11-delige extractorset
TTXPB3	100690106	6	koevoetset 300-400-500mm 3dlg

HD MASTER TOOLSET 385 - 445 - 495

TT1435 TT3819 TT1218 TTAF32



TTXEXT13

Inhoud
-1/4": 4-13mm
-Bit: 1/4", Plat, PH, PZ, TPX, Hex
-3/8": 8-22mm
-1/2": 10-24mm
-1/4": 3/16", 1/2", 3/8", 3/8"
-3/4"
-1/4": 3/8", 1/2"

TTX7 TT00 TTAU TT917N



TTX918N

Inhoud
-TX/TPX 10-40
-3x10 clips 1/4", 3/8", 1/2"
-Plat, PH, PZ
-Plat, PH

TTID20 TTPC09 TT1215AF TTSN11



TTXPB3

Inhoud
-Plat, PH, Hex, TX
-3-8mm
-1/2": 3/8" - 1 1/4"
-7/64: 10/16, extract: 6-12
-L: 300-400 & 500mm

TT440 TT474-7 TT1236 TT3592



TTX2640

Inhoud
-Tangen
-Circelgaten
-8-19mm
-5/16"-3/4"
-13/15"-1 1/4"

TTPS09E



TTX00 + MDSCR + 920230 + 600536 + 710G

Inhoud
-Service tray
-Schroper
-Slagkop 1/2"
-Steekringsleutel/36mm

TT6508R TTHEX7 TTADP17 TTMO8



TTX6311

Inhoud
-8-19mm
-Hex 2,5-8mm
-1/4": 3/8", 1/2"-3/4"
-Inspectiezet
-6-32mm
-Griplang

409

128600103

SET 385

SET 445

SET 495

TTBS35 TTHEX7AF TTHT28 TTMD74



TTX00 + 3892AG-E3

Inhoud
-1/4": plat, PH, PZ, TX
-3/8" hex mm/inch
-Hex 3/32", 5/16"
-Hex 1,5-10mm
-8,5/54" - 3/8", 1/4"
-Bits: plat, PH, PZ, Hex, TX, TPX, SG
-3/8" 20-110Nm

Orig. nr.	Order nr.	Lade	385	445	495	Omschrijving
TT1218	39180104	1	✓	✓	✓	18-delige doppenzet 1/2"
TT1435	03490109	1	✓	✓	✓	35-delige doppenzet 1/4"
TT3819	03520103	1	✓	✓	✓	19-delige doppenzet 3/8"
TTAF32	68610104	1	✓	✓	✓	32-delige doppenzet 1/4" en 3/8" kort/lang
TTXEXT13	68870104	1	✓	✓	✓	13-delige verlengstukken
TT440	44280105	2	✓	✓	✓	4-delige tangenset
TT474-7	04030102	2	✓	✓	✓	4-delige 7" circlipstang
TT1236	27560101	2	✓	✓	✓	12-delige set met metrische steekringsleutels
TT3592	58050303	2	✓	✓	✓	8-delige steekringsleutels AF 8
TTX2640	68910207	2	✓	✓	✓	7-delige AF steekleutels
TTBS35	132150103	3	✓	✓	✓	35-delige dop- en bitset 1/4
TTHEX7AF	68930205	3	✓	✓	✓	7-delige metrische T-hendelset
TTHT28	128250107	3	✓	✓	✓	28-delige hex en Tx-set
TTMD74	144030103	3	✓	✓	✓	74-delige bitset met ratel
TTX00	101030203	3	✓	✓	✓	Ledige TX-tray lang model
3892-E3	73190076	3	✓	✓	✓	Momentsleutel 3/8" 19-110Nm
TTX7	68920107	4	✓	✓	✓	7-delige TX/TPX T-handvat torxsset
TT00	04160107	4	✓	✓	✓	Ledige Tc-tray
TTAU	03890100	4	✓	✓	✓	32-delige dop clip rail set
TT917N	174400101	4	✓	✓	✓	Set van 7 schroevendraaiers plat, PH en PZ. TT-MV PLUS staal
TTX918N	174500108	4	✓	✓	✓	5-delige schroevendraaierset plat en PH waarvan 2 stubby
TTPS09E	117060103	5	✓	✓	✓	9-delige hamerkit
600536	72672702	5	✓	✓	✓	Steekringsleutel 36mm jumbo
MD-SCR	03130101	5	✓	✓	✓	Pakkingschraper 24mm x 245mm
920230	114872807	5	✓	✓	✓	Slagkop diep 1/2" 6 - 15/16"
TTX00	101030203	5	✓	✓	✓	Ledige TX-tray lang model
TTID20	102100104	6	✓	✓	✓	20-delige slagschroevendr. set 1/2
TTPC09	69220101	6	✓	✓	✓	9-delige beitel- en doorslagset Tc-tray
TT1215AF	03570306	6	✓	✓	✓	15-delige doppenzet 1/2" AF
TTSN11	69340107	6	✓	✓	✓	11-delige extractorset
TTXPB3	100690106	6	✓	✓	✓	3-delige koevoetset
TT6508R	109730101	7	✓	✓	✓	8-delige ratel-steekringsleutel Tc-tray
TTHEX7	68930106	7	✓	✓	✓	7-delige metrische T-hendelset
TTADP17	185800109	7	✓	✓	✓	17-delige adaptor set - TC tray
TTMO8	144370103	7	✓	✓	✓	8-delige inspectiezet
TTX6311	68910157	7	✓	✓	✓	11-delige ringsleutels Tx-tray 6-32mm
580	15610108	7	✓	✓	✓	Magnetische bits tray
409	117780106	7	✓	✓	✓	Multifunctionele tang met een verstelbare opening van 53 tot 118 mm.
LIMIT300	128600103	7	✓	✓	✓	Multimeter



TCW807NS

**SET
385**

**SET
445**

**SET
495**

TCHD385NS 801008596	TCHD445NS 801008600	TCHD495NS 801008604
TCHD385N 801008594	TCHD445N 801008598	TCHD495N 801008602
TCHD385X 801008661	TCHD445X 801008662	TCHD495X 801008663
TCHD385SV 801008593	TCHD445SV 801008597	TCHD495SV 801008601
TCHD385NW 801008617	TCHD445NW 801008618	TCHD495NW 801008619

**SET
p. 84**



TCW807N



TCW907X



TCW707EV



TCW807NW

TENGTTOOLS

PRIJS TOOLSET IS INCL. GEREEDSCHAPSWAGEN

Order nr.	Orig. nr.	Type wagen	Aantal stuks	Afmetingen (l x b x h) mm	Gewicht kg	Prijs €
801008596	TCHD385NS	TCW807NS	385	670x460x950	91,70	1.449,00
801008594	TCHD385N	TCW807N	385	670x460x950	102,70	1.429,00
801008661	TCHD385X	TCW907X	385	670x460x950	91,70	1.534,00
801008593	TCHD385SV	TCW807SV	385	670x460x950	95,70	1.359,00
801008617	TCHD385NW	TCW807NW	385	670x460x950	102,70	1.449,00
801008600	TCHD445NS	TCW807NS	445	670x460x950	98,50	1.599,00
801008598	TCHD445N	TCW807N	445	670x460x950	109,49	1.579,00
801008662	TCHD445X	TCW907X	445	670x460x950	98,49	1.719,00
801008597	TCHD445SV	TCW807SV	445	670x460x950	110,76	1.519,00
801008618	TCHD445NW	TCW807NW	445	670x460x950	109,49	1.599,00
801008604	TCHD495NS	TCW807NS	495	670x460x950	106,76	1.809,00
801008602	TCHD495N	TCW807N	495	670x460x950	117,76	1.789,00
801008663	TCHD495X	TCW907X	495	670x460x950	106,76	2.084,00
801008601	TCHD495SV	TCW807SV	495	670x460x950	110,76	1.729,00
801008619	TCHD495NW	TCW807NW	495	670x460x950	117,76	1.809,00

TOOLS

HUSQVARNA-ROCKSTAR JM RACING TEAM

Het JM racing team, onder leiding van Jacky Martens, is de technische partner voor de Europese activiteiten van het Husqvarna-Rockstar motorcross-team. Ook zij kiezen voor Teng Tools!

Jacky Martens bracht in 1993 een revolutie in de motorcross teweeg door met een 633cc viertakt Husqvarna de wereldtitel te veroveren. Het was Martens gelukt een middelmatig presterende motor om te tunen naar een krachtige GP machine waarmee, hij de door tweetakmachines gedomineerde concurrentie, het nakijken gaf. Deze wereldtitel is het hoogtepunt van een actieve motorsportcarrière met talloze (inter-) nationale en Grand Prix overwinningen die meer dan 20 jaar omspan.

“In het JM Racing team draait alles om leren en groeien in het MX racen”, zegt bezieler en teambaas Jacky Martens.





Get organised™



JM RACING KIEST VOOR TENG TOOLS

“Om succesvol te zijn in onze sport, is degelijk gereedschap waarop we kunnen vertrouwen, onontbeerlijk. Daarom kiezen we resoluut voor Teng Tools.

We hebben de Teng Tools HD Motorset 495 speciaal voor ons team ontworpen, samen met de productspecialisten van VYNCKIER.

Het is ons doel om een professioneel kader te creëren rondom een mix van jonge talentrijke en ervaren rijders, die zich hierin ontwikkelen tot MX toppers van wereldklasse. JM Racing voorziet zijn rijders van verfijnde technische know-how en een aangepaste persoonlijke training gebaseerd op tientallen jaren van GP ervaring. De rijders strijden in de MX1 en MX2 klasse op internationaal en Grand Prix niveau.”





Get organised™



EVA FOAM MASTER TOOLSET 333



TTEMB11

11 dlg
Tangen



TTEX32
32 dlg
Skr. 8-32mm
Ratelstkr.
8-19mm
L. 250mm



TTEPS12

12 dlg.
Service tray



TTEMD98N
98 dlg.
Plat, PH,
PZ - 1000V



TTESK77

77 dlg
1/4" 4-13mm &
6-13mm
3/8" 8-22mm
1/2" 10-24mm
12kant
1/2" impact
13-24mm



TTEX17
17 dlg.
Hex 2,5-8mm
TX 10-40
1/2" 40-
200Nm



TTESK85

85 dlg.
1/4" TX10-40,
PH0-3, Plat,
PZ1-3
3/8" TX/TPX
10-50, TXE 10-
18, hex 3-12
1/2" TX 20-60,
hex 5-12, Ribe
4-13, spl 5-16

**VOLLEDIG AANBOD
EVA FOAM MASTER MOTOR TOOLSETS**

p. 95

BESTSELLER

TENGI TOOLS

Set "EVA foam trays" 333-delig in gereedschapswagen 7 laden gevuld, bestaande uit:

- Gereedschapswagen 7 laden TCW807NW
- Doppen en bitsset 85dlg EVA-tray
- Doppenset en acc. 1/4, 3/8 en 1/2 77dlg EVA-tray
- 1/2" slagdoppen kort: 13-24mm
- 1/2" doppen lang: 13-24mm
- 1/2" doppen kort: 10-24mm
- 1/4" doppen kort: 4-13mm
- 1/4" doppen lang: 6-13mm
- 3/8" doppen kort: 8-22mm
- Tangenset 11dlg EVA-tray
- Schroevendraaier- en bitsset 98dlg EVA-tray
- Hex sleutel en inspectieset 17dlg EVA-tray
- Sleutel en vijlenset 32dlg EVA-tray
- Steekringsleutels: 8-32mm
- Ringsleutels
- Basistools 12dlg EVA-tray

Order nr.	801008621 ⓘ		
Orig. nr.	TCEM333NW		
Omschrijving	EVA Master Toolset 333 in wagen GW107		
Gewicht	kg	85,00	
Afmetingen (l x b x h)	mm	670 x 460 x 950	
Prijs	€	1.929,00	

Samenstellingslijst:

Orig. nr.	Order nr.	Lade	Omschrijving
TTEMB11	178810107	1	Tangenset 11dlg EVA-tray
TTEX32	178870101	2	Sleutel en vijlenset 32dlg EVA-tray
TTEPS12	178830105	3	Basistoolset 12dlg EVA-tray
TTEMD98N	186160107	4	Schroevendraaier- en bitsset 98dlg EVA-tray
TTESK77	178840104	5	Doppenset en acc. 1/4, 3/8 en 1/2 77dlg EVA-tray
TTEX17	178860102	6	Hex sleutel en inspectieset 17dlg EVA-tray
TTESK85	178850103	7	Doppen en bitsset 85dlg EVA-tray

EVA FOAM MASTER TOOLSET 231 - 333 - 278



TTEMB11
11 dlg.
Tangen



TTEX32
32 dlg.
Slkr. 8-32mm
Ratelstr. 8-19mm
L. 250mm



TTEPS12
12 dlg.
Service tray



TTEMD98N
98 dlg.
Plat, PH, PZ - 1000V

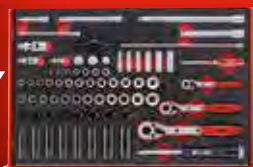

TTESK77
77 dlg.
1/4" 4-13mm &
6-13mm
3/8" 8-22mm
1/2" 10-24mm
1/2" impact 13-24mm

SET
231



TTEX17
17 dlg.
Hex 2,5-8mm
TX 10-40
1/2" 40-200Nm

+



TTESK85
85 dlg.
1/4" TX10-40, PH0-3,
Plat, PZ1-3
3/8" TX/TPX 10-50,
TXE 10-18, hex 3-12
1/2" TX 20-60, hex
5-12, Ribe 4-13, hex
spl 5-16

SET
333



TTEMD122N
122 dlg.
Plat, PH, PZ, TX,
TPX, Hex



TTEMB17
17 dlg.
Tangen



TTESP31
31 dlg.
5,5 - 38mm



TTEX23
23 dlg.
Hex 2,5-8mm
TX 10-40
5-13mm



TTESK86
86 dlg.
1/4" 4-13mm
3/8" 7-22mm

SET
278

Order nr.	Orig. nr.	231	333	278	Omschrijving
178870101	TTEX32	✓	✓		32-delige sleutel & vijlenset
178830105	TTEPS12	✓	✓		12-delige basistoolset
178840104	TTESK77	✓	✓		77-delige doppenset & acc. 1/4, 3/8 & 1/2
178810107	TTEMB11	✓	✓		11-delige tangenset
186160107	TTEMD98N	✓	✓		98-delige schroevendraaier- & bitsset
178810107	TTEX17		✓		17-delige hex sleutel & inspectieset
178850103	TTESK85		✓		85-delige doppen & bitsset
186200101	TTEMD122N			✓	122-delige schroevendraaierset & bitset
161720107	TTEMB17			✓	17-delige tangenset
161750104	TTESP31			✓	86-delige doppenset 1/4" & 3/8" & accessoires 4-22mm
161770102	TTEX23			✓	23-delige T-sleutelset & dop Schroevendraaierset
161680103	TTESK86			✓	31-delige steekringsleutelset 5,5-38mm

PRUIS TOOLSET IS INCL. GEREEDSCHAPSWAGEN

Order nr.	Orig. nr.	Type wagen	Toolset	Prijs €
801201232	TCEM231NFX	TC805NFX	231	1.289,00
801201238	TCEM231806	TCEM806N	231	1.599,00
801201233	TCEM231N	TCW807N	231	1.419,00
801008664	TCEM231X	TCW907X	231	1.634,00
801201237	TCEM231NS	TCW807NS	231	1.475,00
801201234	TCEM231SV	TCW807SV	231	1.315,00
801008620	TCEM231NW	TCW807NW	231	1.475,00
801201334	TCEM333SV	TCW807SV	333	1.789,00
801201333	TCEM333N	TCW807N	333	2.119,00
801008665	TCEM333X	TCW907X	333	2.054,00
801201337	TCEM333NS	TCW807NS	333	1.929,00
801008621	TCEM333NW	TCW807NW	333	1.929,00
801202781	TCEM278NFX	TC805NFX	278	1.319,00
801202786	TCEM278806	TCW806N	278	1.439,00
801202785	TCEM278SV	TCW807SV	278	1.349,00
801202780	TCEM278N	TCW807N	278	1.449,00
801008666	TCEM278X	TCW907X	278	1.789,00
801202783	TCEM278NS	TCW807NS	278	1.505,00
801008622	TCEM278NW	TCW807NW	278	1.505,00

TRAYS

Teng Tools zorgt voor overzicht en netheid op de werkvloer. Waarom een warboel in uw gereedschapsset, als Teng Tools ervoor kan zorgen dat dit overzichtelijk is?

Als een van de beste gereedschapsproducenten in de wereld, bieden wij u een volledig systeem om uw werkplek op orde te krijgen. Het Teng Tools systeem biedt overzicht, zodat ieder stuk gereedschap op de juiste plaats ligt, wat zorgt voor een efficiënte manier van werken. In plaats van alles door elkaar in een lade of koffer zoals het vroeger was.

Elk gereedschap in aparte trays, die door een zwaluwstaart systeem aan elkaar verbonden worden, perfect passend in elke lade van uw Teng Tools kist of gereedschapswagen. Geen verlies van ruimte, elk stuk perfect op zijn plaats. In één overzicht ziet u welk gereedschap ontbreekt.

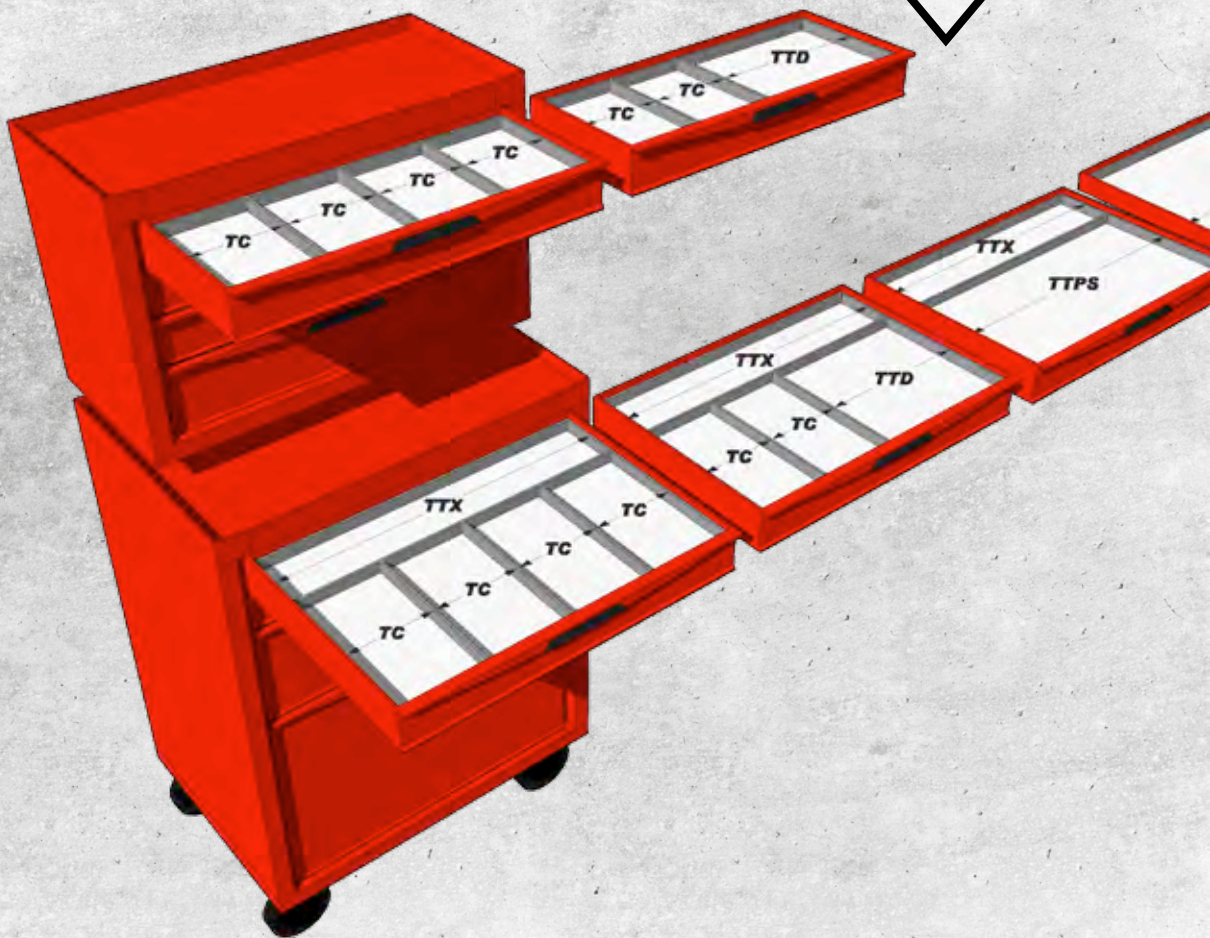



GET ORGANISED IN 3 STAPPEN



1. Kies een opbergsysteem

2. Kies de tools

3. Klik samen en Get Organised

Get organised™



Gereedschap in PS trays

TENGOOLS



Opbergvakje met 2 alu-rails (L.260mm) en 3x10 doppenclips (1/4", 3/8", 1/2").

Kenmerken:

- Met rubbermat op de bodem.
- TC-tray.

Order nr.	03890100	
Orig. nr.	TTALU	
Afmetingen (l x b x h)	mm	265 x 142 x 50
Prijs	€	11,50

TENGOOLS



Leeg opbergvakje.

Kenmerken:

- Met universele houder voor schroevendraaiers of sleutels.
- TC-tray.

Order nr.	04160107	
Orig. nr.	TT00	
Afmetingen (l x b x h)	mm	265 x 142 x 50
Prijs	€	6,90

TENGOOLS



Leeg opbergvakje met vakverdeling. TC-tray.

Order nr.	04160206	
Orig. nr.	TT01	
Afmetingen (l x b x h)	mm	265 x 142 x 50
Prijs	€	8,20

TENGOOLS



Leeg opbergvakje met vakverdeling. TC-tray.

Order nr.	161790100	
Orig. nr.	TT02	
Afmetingen (l x b x h)	mm	265 x 142 x 50
Prijs	€	8,20

TENGOOLS



Leeg opbergvakje met vakverdeling. TC-tray.

Order nr.	161790209	
Orig. nr.	TT03	
Afmetingen (l x b x h)	mm	265 x 142 x 50
Prijs	€	8,20

TENGOOLS



Leeg opbergvakje met vakverdeling. TC-tray.

Order nr.	161790308	
Orig. nr.	TT04	
Afmetingen (l x b x h)	mm	265 x 142 x 50
Prijs	€	8,00

TENGOOLS



Leeg TTX-opbergvakje met rubbermat op de bodem. TTX-tray.

Order nr.	101030203	
Orig. nr.	TTX00	
Afmetingen (l x b x h)	mm	570 x 110 x 40
Prijs	€	8,40

TENGOOLS



Leeg TTX-opbergvakje met vakverdeling. TTX-tray.

Order nr.	109450106	
Orig. nr.	TTX01	
Afmetingen (l x b x h)	mm	570 x 110 x 40
Prijs	€	9,20

TENGOOLS



Leeg TTX-opbergvakje met vakverdeling. TTX-tray.

Order nr.	161780101	
Orig. nr.	TTX02	
Afmetingen (l x b x h)	mm	560 x 110 x 40
Prijs	€	9,30

TENGOOLS



Leeg TTX-opbergvakje met vakverdeling. TTX-tray.

Order nr.	161780200	
Orig. nr.	TTX03	
Afmetingen (l x b x h)	mm	560 x 110 x 40
Prijs	€	9,30

TENGTTOOLS

Leeg opbergvakje met vakverdeling. DTC-tray.

Order nr.	161800107
Orig. nr.	TTD00
Afmetingen (l x b x h)	mm 260 x 280 x 50
Prijs	€ 12,90

TENGTTOOLS

Leeg opbergvakje met vakverdeling. DTC-tray.

Order nr.	161800206
Orig. nr.	TTD01
Afmetingen (l x b x h)	mm 260 x 280 x 50
Prijs	€ 12,90

TENGTTOOLS

Leeg opbergvakje met vakverdeling. DTC-tray.

Order nr.	161800305
Orig. nr.	TTD02
Afmetingen (l x b x h)	mm 260 x 280 x 50
Prijs	€ 12,90

TENGTTOOLS

9-delige basisset. PS-tray.

Bestaande uit:

- 2 schroefslutels
- Griptang 250mm
- Beugelzaag
- Universeel breekmes
- Soft-hamer
- Rolmeter
- Stalen meetlat
- Bolkophamer

Order nr.	106210107
Orig. nr.	TTPS09
Afmetingen (l x b x h)	mm 570 x 262 x 56
Prijs	€ 115,00

TENGTTOOLS

9-delige basisset. PS-tray.

Bestaande uit:

- 2 schroefslutels
- Griptang 250mm
- Beugelzaag
- Universeel breekmes
- Soft-hamer
- Rolmeter
- Stalen meetlat
- DIN1041 hamer

Order nr.	117060103
Orig. nr.	TTPS09E
Afmetingen (l x b x h)	mm 570 x 262 x 56
Prijs	€ 96,90

TENGTTOOLS

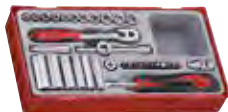

35-delige set. TC-tray.

Bestaande uit:

- 11 korte en 6 lange doppen 1/4" 4-13mm
- 11 bitsen 1/4"
- Ratel
- Elleboogstuk
- Bitshouder
- 2 verlengstukken
- adaptor 3/8"- 1/4"
- Bitschroevendraaier

Order nr.	03490109		
Orig. nr.	TT1435		
Aantal stuks	35		
Doppen 1/4"	mm	4 - 5 - 5,5 - 6 - 7 - 8 - 9 - 10 - 11 - 12 - 13	
Doppen 1/4" lang	mm	6 - 7 - 8 - 9 - 10 - 12 - 13	
Bitsen 1/4" plat	mm	0,8x4 - 1,2x5	
Bitsen 1/4" PH		1 - 2	
Bitsen 1/4" PZ		1 - 2	
Bitsen 1/4" TPX		10 - 15 - 20	
Bitsen 1/4" Hex	mm	5 - 6	
Afmetingen (l x b x h)	mm	265 x 142 x 50	
Prijs	€	48,50	

TENGTTOOLS



19-delige set. TC-tray.

Bestaande uit:

- 13 korte doppen 3/8"
- Ratel
- Adaptor 1/2"-3/8"
- Elleboogstuk
- Bitshouder
- Verlengstuk 75mm
- Schroevendraaier voor doppen 3/8"

Order nr.	03520103		
Orig. nr.	TT3819		
Verlengstuk 3/8"	mm	75	
Aantal stuks	19		
Doppen 3/8"	mm	8 - 9 - 10 - 11 - 12 - 13 - 14 - 15 - 16 - 17 - 18 - 19 - 22	
Ratels	inch	3/8	
Afmetingen (l x b x h)	mm	265 x 142 x 50	
Prijs	€	57,90	

TENGTTOOLS



16-delige set van lange doppen 3/8" 6-kant.

Kenmerken:

- Satijn afwerking.
- TC-tray.

Order nr.	144300100		
Orig. nr.	TT3816		
Doppen 3/8" lang	mm	7 - 8 - 9 - 10 - 11 - 12 - 13 - 14 - 15 - 16 - 17 - 18 - 19 - 20 - 21 - 22	
Afmetingen (l x b x h)	mm	265 x 142 x 50	
Prijs	€	37,90	

TENGTTOOLS



Set van 32 gewone en lange AF doppen 1/4" en 3/8" 6-kant. TC-tray.

Order nr.	68610104		
Orig. nr.	TTAF32		
Aantal stuks	32		
Doppen 1/4"	inch	3/16 - 7/32 - 1/4 - 9/32 - 5/16 - 11/32 - 3/8 - 7/16 - 1/2	
Doppen 1/4" lang	inch	3/16 - 7/32 - 1/4 - 9/32 - 5/16 - 11/32 - 3/8 - 7/16 - 1/2	
Doppen 3/8"	inch	3/8 - 7/16 - 1/2 - 9/16 - 5/8 - 11/16 - 3/4	
Doppen 3/8" lang	inch	3/8 - 7/16 - 1/2 - 9/16 - 5/8 - 11/16 - 3/4	
Afmetingen (l x b x h)	mm	265 x 142 x 50	
Prijs	€	36,90	

TENGTTOOLS



Set van 7 speciale automotive doppen 1/2" en 3/8". TC-tray.

Bestaande uit:

- AT350
- AT355
- AT360
- AT365
- AT370
- AT375
- AT380

Order nr.	144340106		
Orig. nr.	TTSS07		
Accessoires 3/8"	Lucht sensor dop voor Mitsubishi, Nissan, Opel, Vauxhall en VW - Vacuum switch dop - Olie dop - Offset lucht sensor sleutel		
Accessoires 1/2"	Lucht sensor dop for GM - Injector dop for M24		
Afmetingen (l x b x h)	mm	265 x 142 x 50	
Prijs	€	73,90	

TENGOOLS



5-delige set met 1/2" accessoires. TC-tray.

Bestaande uit:

- 1 ratel 1/2"
- 2 verlengstukken L. 125 en 250mm
- 1 elleboogstuk
- 1 adaptor 1/2"-3/8"

Order nr.	03570108
Orig. nr.	TT1205
Afmetingen (l x b x h)	mm 265 x 142 x 50
Prijs	€ 52,50

TENGOOLS



17-delige set. TC-tray.

Bestaande uit:

- 12 doppen 1/2" 12-kant gaande van 10 tot 24mm
- 1 ratel 1/2"
- 2 verlengstukken L. 62,5 en 150mm
- 1 adaptor 1/2"-3/8"
- 1 elleboogstuk

Order nr.	39180104	39180203
Orig. nr.	TT1218	TT12186
Aantal stuks	17	17
Type dop	12-kant	6-kant
Doppen 1/2"	mm 10 · 11 · 12 · 13 · 14 · 15 · 16 · 17 · 18 · 19 · 22 · 24	mm 10 · 11 · 12 · 13 · 14 · 15 · 16 · 17 · 18 · 19 · 22 · 24
Afmetingen (l x b x h)	mm 265 x 142 x 50	mm 265 x 142 x 50
Prijs	€ 65,90	€ 65,90

TENGOOLS



11-delige set. TC-tray.

Bestaande uit:

- 10 lange doppen 1/2" 12-kant.
- 1 handvat 1/2" met flexibele aansluiting 250mm.

Order nr.	122090103
Orig. nr.	TT1211
Doppen 1/2" lang	mm 10 · 11 · 12 · 13 · 14 · 15 · 16 · 17 · 18 · 19
Afmetingen (l x b x h)	mm 265 x 142 x 50
Prijs	€ 54,50

TENGOOLS



Set van 20 korte en lange bitsen Hex met aansluiting Hex 10mm en 12mm. TC-tray.

Geleverd met:

- 1 hex-schroevendraaier
- 1 dopbitshouder 1/2" - 10mm
- 1 dopbitshouder 1/2" - 12mm.

Order nr.	68850106
Orig. nr.	TTHEX23
Bits 10mm, lengte 40mm	mm 5 · 6 · 7 · 8 · 9 · 10
Bits 12mm, lengte 40mm	mm 12 · 14 · 17 · 19
Bits 10mm, lengte 75mm	mm 5 · 6 · 7 · 8 · 9 · 10
Bits 12mm, lengte 75mm	mm 12 · 14 · 17 · 19
Adaptor 1/2"	mm 10 · 12
Schroevendraaier Hex	mm 2
Afmetingen (l x b x h)	mm 242 x 165 x 50
Prijs	€ 39,50

TENGOOLS



Set van 17 MM-doppen 1/2" gaande van 10 tot 32mm. TC-tray.

Order nr.	03570207
Orig. nr.	TT1217
Aantal stuks	17
Type dop	12-kant
Doppen 1/2"	mm 10 · 11 · 12 · 13 · 14 · 15 · 16 · 17 · 18 · 19 · 20 · 21 · 22 · 24 · 27 · 30 · 32
Afmetingen (l x b x h)	mm 265 x 142 x 50
Prijs	€ 39,50

TENGOOLS



Set van 17 MM-doppen 1/2" 6-kant gaande van 10 tot 32mm. TC-tray.

Order nr.	03570256
Orig. nr.	TT12176
Aantal stuks	17
Doppen 1/2" 6-kant	mm 10 · 11 · 12 · 13 · 14 · 15 · 16 · 17 · 18 · 19 · 20 · 21 · 22 · 24 · 27 · 30 · 32
Type dop	6-kant
Afmetingen (l x b x h)	mm 265 x 142 x 50
Prijs	€ 39,50

TENGOOLS



De AF-set bestaat uit 15 doppen 1/2" 12-kant en gaat van 3/8" tot 1 1/4". TC-tray.

Order nr.	03570306		
Orig. nr.	TT1215AF		
Aantal stuks	15		
Doppen 1/2" 12kant	inch	3/8 - 7/16 - 1/2 - 9/16 - 5/8 - 11/16 - 3/4 - 13/16 - 7/8 - 15/16 - 1 - 1 1/16 - 1/8 - 1 3/16 - 1 1/4	
Afmetingen (l x b x h)	mm	265 x 142 x 50	
Prijs	€	39,50	

TENGOOLS



17dlg set adaptors 1/4", 3/8", 1/2", 3/4" biithouders.

Order nr.	185800109		
Orig. nr.	TIADP17		
Adaptor M/F	3/8x1/2 - 1/2x3/8 - 3/4x1/8 - 1/4x3/8 - 3/8x1/4 - 1/2x3/4 - 1x3/4		
Bitshouder magnetisch	1/4 50mm - 1/4 70mm		
Bitshouder met snelspankop	1/4 50mm		
Bitshouder	1/4		
Adaptor	3/8F x 1/4 bitsen - 1/4Mx1/4 hex - 3/8M met 1/4 hex - 1/4 6-kant naar 1/2 vierkant - 1/4 6-kant naar 1/4 vierkant - 1/4 6-kant naar 3/8 vierkant		
Prijs	€	46,90	

TENGOOLS



Set van 20 korte en lange bitsen Tx met aansluiting Hex 10mm en 12mm. TC-tray.

Geleverd met:

- 1 hex-schroevendraaier
- 1 dopbitshouder 1/2" - 10mm
- 1 dopbitshouder 1/2" - 12mm.

Order nr.	68860105		
Orig. nr.	TTTX23		
Schroevendraaier Hex	mm	2	
Bits 10mm, lengte 40mm TX	20 - 25 - 27 - 30 - 40 - 45 - 50 - 55		
Bits 12mm, lengte 40mm TX	60 - 70		
Bits 10mm, lengte 75mm TX	20 - 25 - 27 - 30 - 40 - 45 - 50 - 55		
Bits 12mm, lengte 75mm TX	60 - 70		
Dopbits houder 1/2"	mm	10 - 12	
Afmetingen (l x b x h)	mm	265 x 142 x 50	
Prijs	€	36,50	

TENGOOLS



NEW

Set van 18 lange dopbitsen 55 mm en 100 mm. Type TX 1/2". Satijnafwerking.

Geleverd in een TC tray met afneembaar deksel.

Order nr.	231890104		
Orig. nr.	TTTTX18		
Dopbitsen TX 55mm	TX20-TX25-TX27-TX30-TX40-TX45-TX50-TX55-TX60		
Dopbitsen TX 100mm	TX20-TX25-TX27-TX30-TX40-TX45-TX50-TX55-TX60		
Prijs	€	50,50	

TENGOOLS



NEW

Set van 16 lange dopbitsen 55 mm, 100 mm en 115 mm. Type HEX 1/2". Satijnafwerking.

Geleverd in een TC tray met afneembaar deksel.

Order nr.	237660105		
Orig. nr.	TTHEX16		
Dopbitsen HEX 55 mm	mm	5-6-7-8-9-10-12-14-17	
Dopbitsen HEX 100 mm	mm	5-6-10-12-14-17	
Dopbitsen HEX 115 mm	mm	8	
Prijs	€	48,40	

TENGOOLS



30-delige set. TC-tray.

Bestaande uit:

- 18 dopbitsen 1/4" en 3/8" TX en TPX
- 10 doppen 3/8" E-tx

Geleverd met

- Adaptor 3/8"-1/4"
- 1 verlengstuk 3/8" L.75mm

Order nr.	102140100		
Orig. nr.	TTTTX30		
Dopbitsen 3/8" TX	10 - 15 - 20 - 25 - 27 - 30 - 40 - 45 - 50		
Dopbitsen 3/8" TPX	10 - 15 - 20 - 25 - 27 - 30 - 40 - 45 - 50		
Doppen 1/4" E	4 - 5 - 6 - 7 - 8		
Doppen 3/8" E	10 - 12 - 14 - 16 - 18		
Afmetingen (l x b x h)	mm	265 x 142 x 50	
Prijs	€	58,90	

TENGOOLS



35-delige set. TC-tray.

Bestaande uit:

- Dopbitsen 1/4" en 3/8" Plat, Ph, Pz, Tx en Hex
- Een adaptor 3/8"-1/4" en 1/4"-3/8".

Order nr.	132150103		
Orig. nr.	TTBS35		
Dopbitsen 1/4" plat	mm	4 - 4,5 - 7	
Dopbitsen 1/4" PH		0 - 1 - 2 - 3	
Dopbitsen 1/4" PZ		1 - 2 - 3	
Dopbitsen 1/4" TX		10 - 15 - 20 - 25 - 27 - 30 - 40	
Dopbitsen 3/8" Hex	inch	1/8 - 5/32 - 3/16 - 7/32 - 1/4 - 5/16 - 3/8	
Afmetingen (l x b x h)	mm	265 x 142 x 50	
Prijs	€	40,50	

TENGOOLS



15-delige set bestaande uit 15 dopbitsen 1/2" RIB en SPL L.100mm. TC-tray.

Order nr.	143880102		
Orig. nr.	TTRS15		
Dopbitsen 1/2" RIB	mm	4 - 5 - 6 - 8 - 10 - 11 - 12 - 13	
Dopbitsen 1/2" SPL	mm	5 - 6 - 8 - 10 - 12 - 14 - 16	
Afmetingen (l x b x h)	mm	265 x 142 x 50	
Prijs	€	63,90	

TENGOOLS



Set van 15 lange (L.100mm) dopbitsen 1/2" TX en Hex.

Kenmerken:

- Gaande van TX20 tot TX60.
- Hex 5 tot 12mm.
- TC-tray.

Order nr.	118890102		
Orig. nr.	TTTXH15		
Aantal stuks	15		
Dopbitsen 1/2" TX		20 - 25 - 27 - 30 - 40 - 45 - 50 - 55 - 60	
Dopbitsen 1/2" Hex	mm	5 - 6 - 7 - 8 - 10 - 12	
Afmetingen (l x b x h)	mm	265 x 142 x 50	
Prijs	€	56,90	

TENGOOLS



13-delige set.

Bestaande uit

- 6 verlengstukken 1/4", 3/8" en 1/2"
- 3 elleboogstukjes 1/4", 3/8" en 1/2"
- 1 adaptor 3/8"-1/4"
- 1 T-handvat
- 2 mini-schroevendraaiers Hex 2.0 en 2.5mm

Kenmerken:

- Met het korte en lange verlengstuk kan een T-hendel worden gemaakt dankzij de opening in de aansluitingskant.
- Het T-handvat dient als handgreep op het korte verlengstuk.
- TTX-tray.

Order nr.	68870104		
Orig. nr.	TTXEXT13		
Verlengstukken 1/4"	mm	150 - 300	
Verlengstuk 3/8"	mm	75 - 500	
Verlengstukken 1/2"	mm	75 - 500	
Afmetingen (l x b x h)	mm	560 x 110 x 40	
Prijs	€	74,90	

TENGOOLS



9-delige lange doppen set met een T-staaf. 3/8" aansluiting. TTX tray.

Order nr.	178791109		
Orig. nr.	TTXTB09		
Doppen 3/8"	mm	8, 10, 12, 13, 14, 17, 19	
T-baar	mm	300	
Afmetingen (l x b x h)	mm	560 x 110 x 40	
Prijs	€	70,90	

TENGOOLS



4-delige set. TTX-tray.

Bestaande uit:

- 1 ratel 3/4" 40-tands
- 1 vaste T-hendel 3/4"
- 2 verlengstukken 3/4" L. 200 en 400mm.

Order nr.	101530103		
Orig. nr.	TTX3404		
Afmetingen (l x b x h)	mm	570 x 110 x 70	
Prijs	€	129,00	

TENGOOLS



Set van 14 doppen 3/4" gaande van 19 tot 50mm (6-kant). TTX-tray.

Order nr.	101540102		
Orig. nr.	TTX3414		
Doppen 3/4" 6-kant	mm	19 - 21 - 22 - 24 - 27 - 30 - 32 - 33 - 34 - 36 - 38 - 41 - 46 - 50	
Afmetingen (l x b x h)	mm	570 x 110 x 74	
Prijs	€	108,00	

TENGOOLS



Set van 14 doppen 3/4" gaande van 7/8" tot 1 7/8" (12-kant). TTX-tray.

Order nr.	101540201		
Orig. nr.	TTX34AF		
Doppen 3/4"	inch	7/8 - 15/16 - 1 - 1 1/16 - 1 1/8 - 1 3/16 - 1 1/4 - 1 5/16 - 1 3/8 - 1 7/16 - 1 1/2 - 1 5/8 - 1 3/4 - 1 7/8	
Afmetingen (l x b x h)	mm	570 x 110 x 74	
Prijs	€	108,00	

TENGOOLS



Set van 10 stubby (korte) steekringsleutels gaande van 10 tot 19mm.

Kenmerken:

- De ringkant heeft een hellingshoek van 15°.
- TC-tray.

Order nr.	109470104		
Orig. nr.	TT6010M		
Aantal stuks	10		
Steekringsleutels	mm	10 - 11 - 12 - 13 - 14 - 15 - 16 - 17 - 18 - 19	
Afmetingen (l x b x h)	mm	256 x 142 x 50	
Prijs	€	45,50	

TENGOOLS



Set van 12 steekringsleutels gaande van 8 tot 19mm. TC-tray.

Order nr.	27560101		
Orig. nr.	TT1236		
Aantal stuks	12		
Steekringsleutels	mm	8-9-10-11-12-14-15-16-17-18-19	
Afmetingen (l x b x h)	mm	265 x 142 x 50	
Prijs	€	44,50	

TENGOOLS



Set van 8 steekringsleutels AF gaande van 5/16" tot 3/4".

Kenmerken:

- De ringkant heeft een hellingshoek van 15°.
- Identieke maten aan beide kanten van de sleutel.
- TC-tray.

Order nr.	58050303		
Orig. nr.	TT3592		
Aantal stuks	8		
Steekringsleutels	5/16 - 3/8 - 7/16 - 1/2 - 9/16 - 5/8 - 11/16 - 3/4		
Afmetingen (l x b x h)	mm	265 x 142 x 50	
Prijs	€	38,50	

TENGOOLS



Set van 7 steekringsleutels gaande van 20 tot 32mm.

Kenmerken:

- De ringkant heeft een hellingshoek van 15°.
- Identieke maten aan beide kanten van de sleutel.
- TTX-tray.

Order nr.	68910108		
Orig. nr.	TTX2032		
Aantal stuks	7		
Maat	mm	20 - 21 - 22 - 24 - 27 - 30 - 32	
Afmetingen (l x b x h)	mm	560 x 110 x 40	
Prijs	€	73,50	

TENGOOLS



Set van 7 steekringsleutels gaande van 13/15" tot 1 1/4".

Kenmerken:

- De ringkant heeft een hellingshoek van 15°.
- Identieke maten aan beide kanten van de sleutel.
- TTX-tray.

Order nr.	68910207		
Orig. nr.	TTX2640		
Aantal stuks	7		
Maat	inch	13/16 - 7/8 - 15/16 - 1 - 1 1/16 - 1 1/8 - 1 1/4	
Afmetingen (l x b x h)	mm	560 x 110 x 40	
Prijs	€	77,90	

TENGOOLS



Set van 12 lange steekringsleutels met dezelfde maat aan beide uiteinden.

Kenmerken:

- Ringkant 12-kant met hellingshoek 15°.
- Geleverd in een TTX-tray die geschikt is voor de Teng Tools koffers en gereedschapswagens.

Order nr.	185870102		
Orig. nr.	TTXLM12		
Aantal stuks	12		
Maten	mm	8 - 9 - 10 - 11 - 12 - 13 - 14 - 15 - 16 - 17 - 18 - 19	
Prijs	€	59,50	

TENGOOLS



Set van 8 ratel-steekringsleutels gaande van 8 tot 19mm. TC-Tray.

Kenmerken:

- Identieke maten aan beide kanten van de sleutel.
- Ringkant 12-kant met hellingshoek 15°
- Handige omschakelknop voor het wijzigen van de draairichting.
- Aktiehoek 5°.

Order nr.	109730101		
Orig. nr.	TT6508R		
Aantal stuks	8		
Sleutels	mm	8 · 10 · 11 · 12 · 13 · 14 · 17 · 19	
Afmetingen (l x b x h)	mm	265 x 142 x 50	
Prijs	€	123,00	

TENGOOLS



Set van 8 ratel-steekringsleutels gaande van 5/16" tot 3/4". TC-Tray.

Kenmerken:

- Identieke maten aan beide kanten van de sleutel.
- Ringkant 12-kant met hellingshoek 15°
- Handige omschakelknop voor het wijzigen van de draairichting.
- Aktiehoek 5°.

Order nr.	109730200		
Orig. nr.	TT6508RAF		
Aantal stuks	8		
Ratel-steekringsleutels		5/16" · 3/8" · 7/16" · 1/2" · 9/16" · 5/8" · 11/16" · 3/4"	
Maatsysteem		inch	
Prijs	€	130,00	

TENGOOLS



Set van 8 ratel-steekringsleutels gaande van 8 tot 19mm. TC-tray.

Kenmerken:

- Identieke maten aan beide kanten van de sleutel.
- Model zonder omschakelknop.
- Platte sleutel.

Order nr.	166720102		
Orig. nr.	TT6508RS		
Aantal stuks	8		
Sleutels	mm	8 · 10 · 11 · 12 · 13 · 14 · 17 · 19	
Afmetingen (l x b x h)	mm	265 x 142 x 50	
Prijs	€	98,50	

TENGOOLS



Set van 8 swivel-ratel-steekringsleutels gaande van 8 tot 19mm. TC-tray.

Kenmerken:

- Swivel-zijde is 180° klinkbaar.
- Identieke maten aan beide kanten van de sleutel.

Order nr.	131900102		
Orig. nr.	TT6508RF		
Aantal stuks	8		
Ratel-steekringsleutels		8 · 10 · 11 · 12 · 13 · 14 · 17 · 19	
Afmetingen (l x b x h)	mm	265 x 142 x 50	
Prijs	€	115,00	

TENGOOLS



11-delige ratel-steekringsleutel set.

Kenmerken:

- Vervaardigd uit hoogwaardig chroom vanadium staal.
- Matverchromd.
- Identieke maten aan beide uiteinden.
- Ringkant 12-kant met hellingshoek 15° en handige omschakelknop voor het wijzigen van de draairichting.
- Actiehoek 5°.

Order nr.	186740106		
Orig. nr.	TT6511R		
Aantal stuks	11		
Maten	mm	8, 9, 10, 11, 12, 13, 14, 15, 16, 17, 19	
Prijs	€	157,00	

TENGOOLS



Set van 11 ratel-steekringsleutels gaande van 8 tot 19mm. TC-tray.

Kenmerken:

- Identieke maten aan beide kanten van de sleutel.
- Model zonder omschakelknop.
- Platte sleutel.

Order nr.	186750105		
Orig. nr.	TT6511RS		
Aantal stuks	11		
Maten	mm	8, 9, 10, 11, 12, 13, 14, 15, 16, 17, 19	
Prijs	€	140,00	

TENGOOLS



Set van 11 dubbele ringsleutels gaande van 6 tot 32mm. TTX-tray.

Order nr.	68910157		
Orig. nr.	TTX6311		
Aantal stuks	11		
Ringsleutels	mm	6x7 - 8x9 - 10x11 - 12x13 - 14x15 - 16x17 - 18x19 - 20x22 - 21x23 - 24x27 - 30x32	
Afmetingen (l x b x h)	mm	560 x 110 x 40	
Prijs	€	91,50	

TENGOOLS



Set van 8 dubbele steeksleutels gaande van 6 tot 22mm.

Kenmerken:

- Chroom vanadium staal.
- TC-tray.

Order nr.	03900107		
Orig. nr.	TT6208		
Steeksleutels	mm	6x7 - 8x9 - 10x11 - 12x13 - 14x15 - 16x17 - 18x19 - 20x22	
Afmetingen (l x b x h)	mm	265 x 142 x 50	
Prijs	€	30,90	

TENGOOLS



Set van 6 dubbele flex-ringsleutels 12-kant gaande van 8 tot 19mm.

Kenmerken:

- Verschillende maten aan beide kanten.
- TC-tray.

Order nr.	73000101		
Orig. nr.	TT6506		
Aantal stuks	6		
Sleutels	mm	8x9 - 10x11 - 12x13 - 14x15 - 16x17 - 18x19	
Prijs	€	68,90	

TENGOOLS



7-delige open pijpringsleutelset.

Kenmerken:

- Speciaal ontworpen om pijp- en slangkoppelingen te openen en aan te spannen.
- Ideaal voor beperkte ruimtes zoals hydraulische toepassingen.
- De ring ratel is eenvoudig te openen.
- 12-kant.

Order nr.	186780102		
Orig. nr.	TTXQRS07		
Maat	mm	13 14 16 22 24 27 32	
Prijs	€	214,00	

TENGOOLS



Set van 6 dubbele ratel-ringsleutels 12-kant gaande van 6 tot 22mm. TC-tray.

Order nr.	116700105		
Orig. nr.	TTRORS		
Aantal stuks	6		
Ringsleutels	mm	6x8 - 7x9 - 10x13 - 12x14 - 17x19 - 21x22	
Afmetingen (l x b x h)	mm	265 x 142 x 50	
Prijs	€	47,90	

TENGOOLS



Set. TC-tray.

Bestaande uit:

- 3 haakpinsleutels met 3 pin adaptors
- 2 extra pinnen van 6 en 8mm.

Order nr.	102120102		
Orig. nr.	TTHP08		
Haakpinsleutels voor diameter	mm	19 - 50, 30 - 75, 50 - 120	
Pin adaptors met pin diameter	mm	4 - 5 - 6	
Extra pinnen diameter	mm	6 - 8	
Prijs	€	80,90	

TENGOOLS



4-delige schroefleutelset. Met schaalverdeling. TC-tray.

Order nr.	166730101	
Orig. nr.	TTADJ04	
Capaciteit	mm	24 - 28 - 33 - 38
Schroefleutels	mm	150 - 200 (2x) - 250
Afmetingen (l x b x h)	mm	265 x 142 x 50
Prijs	€	70,90

TENGOOLS



Set van 3 Teng ratels 72-tands van 1/4", 3/8" en 1/2". TC-tray.

Order nr.	128210101	
Orig. nr.	TT7203	
Aantal stuks	3	
Ratels	inch	1/4 - 3/8 - 1/2
Afmetingen (l x b x h)	mm	265 x 142 x 50
Prijs	€	85,90

TENGOOLS



Set van 7 allensleutels met T-hendel gaande van 2.5 tot 8mm.

Kenmerken:

- Met bolkop aan de lange kant van de sleutel.
- TC-tray.

Order nr.	68930106	
Orig. nr.	TTHX7	
Aantal stuks	7	
Sleutels	mm	2,5 - 3 - 4 - 5 - 6 - 7 - 8
Afmetingen (l x b x h)	mm	265 x 142 x 50
Prijs	€	32,50

TENGOOLS



Set van 7 allensleutels met T-hendel gaande van 3/32" tot 5/16".

Kenmerken:

- Met bolkop aan de lange kant van de sleutel.
- TC-tray.

Order nr.	68930205	
Orig. nr.	TTHX7AF	
Aantal stuks	7	
Maat	inch	3/32 - 1/8 - 5/32 - 3/16 - 7/32 - 1/4 - 5/16
Afmetingen (l x b x h)	mm	265 x 142 x 50
Prijs	€	32,90

TENGOOLS



28-delige allensleutelset MM, AF en TX. Geleverd in 3 handige sets.

Order nr.	128250107	
Orig. nr.	TTHT28	
Maat	inch	5/64 - 3/32 - 1/8 - 5/32 - 3/16 - 7/32 - 1/4 - 5/16 (1479AF) - 3/8
Maat	mm	1,5 - 2 - 2,5 - 3 - 4 - 5 - 6 - 8 - 10 (1479mm)
Maat TX	8 - 9 - 10 - 15 - 20 - 25 - 27 - 30 - 40 (1479TX)	
Allensleutel met ball-point	mm	7
Afmetingen (l x b x h)	mm	265 x 142 x 50
Prijs	€	41,90

TENGOOLS



Set van 7 sleutels TX/TPX met T-hendel. TC-tray.

Kenmerken:

- Gaande van TX-TPX10 tot TX-TPX40.
- Met TPX aan de korte kant van de sleutel.

Order nr.	68920107	
Orig. nr.	TTTTX7	
Aantal stuks	7	
Sleutels TX	10 - 15 - 20 - 25 - 27 - 30 - 40	
Afmetingen (l x b x h)	mm	265 x 142 x 50
Prijs	€	31,90

TENGOOLS



74 delige set. TC-tray.

Bevat:

- Ratel bit schroevendraaier
- 6" flexibel verlengstuk
- 4" verlengstuk
- 1/4" M x 1/4" hex adaptor
- koppel adaptor
- 69 bitsen

Order nr.	144030103	
Orig. nr.	TTMD74	
Bitsen 1/4" Hex aansluiting 25mm plat	mm	0,6x3,5 - 0,6x4,5 - 0,8x4 - 0,8x5,5 - 1x5,5 - 1,2x5 - 1,2x6,5 - 1,4x7 - 1,6x8
Bitsen 1/4" Hex aansluiting 25mm PH	1 (x4) - 2(x7) - 3	
Bitsen 1/4" Hex aansluiting 25mm PZ	1 (x4) - 2(x7) - 3	
Bitsen 1/4" Hex aansluiting 25mm TX	6 - 7 - 8 - 9 - 10 - 15 - 20 (x3) - 25 (x3) - 27 - 30 - 40	
Bitsen 1/4" Hex aansluiting 25mm TPX	10 - 15 - 20 (x2) - 25 (x2) - 27 - 30 - 40	
Bitsen 1/4" Hex aansluiting 25mm Hex	mm	2 - 3 - 4 - 5 - 6 - 8
Bitsen 1/4" Hex aansluiting 25mm SQ	1 - 2 - 3	
Bitsen 1/4" Hex aansluiting 25mm GR	2 (x3)	
Prijs	€	37,50

TOOLS

TENGOOLS



NEW

Ratel bit schroevendraaier 1/4". 64 delige set in een TC tray met afneembaar deksel.

Bevat:

- Ratel bit schroevendraaier met ploibaar handvat
- 11 doppen 1/4"
- 52 bitsen

Order nr.	237720107		
Orig. nr.	TTMDRT64		
Aantal stuks	64		
Bitsen 1/4" plat	mm	0,6x3,5-0,6x4,5-0,8x4,0-0,8x5,0-0,8x5,5-1,0x5,5-1,2x6,5-1,2x7,0-1,6x8,0	
Bitsen 1/4" PH		PH1x4-PH2x4-PH3x2	
Bitsen 1/4" PZ		PZ1-PZ2x3-PZ3x2	
Bitsen 1/4" TX		TX6-TX7-TX8-TX9-TX10-TX15-TX20x3-TX25x3-TX27-TX30-TX40	
Bitsen 1/4" Rob		S1-S2S3	
Bitsen 1/4" Hex		hex2-hex3-hex4x3-hex5-hex6-hex8	
Doppen 1/4"	mm	4-5,5-6-7-8-9-10-11-12-13	
Adapter	inch	1/4	
Prijs	€	40,80	

TENGOOLS



Set. TC-tray.

Bestaande uit:

- 11 lange dubbelzijdige bitsen Plat, PH en PZ
- een ergonomisch zwart-rood twee componenten handvat

Order nr.	128650108		
Orig. nr.	TTMD12D		
Schacht PH		1x2 - 1x6,5	
Schacht Plat	mm	4,0x5,5	
Schacht PZ		1x2	
Schacht TX		10x15 - 20x25 - 30x40	
Maat Hex	mm	3x3 met bolkop, 4x4 met bolkop, 5x5 met bolkop, 6x6 met bolkop	
Prijs	€	32,50	

TENGOOLS



16-delige set bestaande uit 12 mini-schroevendraaiers Plat, Ph en Tx en 4 mini-tangen. TC-tray.

Order nr.	104450101		
Orig. nr.	TTMI16		
Schroevendraaiers Plat	mm	2,0x40 - 2,4x40 - 3,0x40	
Schroevendraaiers PH	mm	00(x40) - 0(x40)	
Schroevendraaiers TX	mm		
Tang kopknip	mm	114	
Zijkniptang	mm	125	
Lange bektang	mm	125	
Prijs	€	61,50	

TENGOOLS



Set van 14 schroevendraaiers plat, PH en PZ in Teng TTD tray.

Kenmerken:

- Met een ergonomisch zwart-rood twee componenten handvat.

Order nr.	174370106		
Orig. nr.	TTD914N		
Schroevendraaiers Plat	mm	0,5x3x75 - 0,6x3,5x100 - 1,0x5,5x75 - 1,2x6,5x38 - 1,0x5,5x125 - 1,2x6,5x100	
Schroevendraaiers PH	mm	0(x75) - 1(x75) - 2(x38) - 2(x100)	
Schroevendraaiers PZ	mm	0(x75) - 1(x75) - 2(x38) - 2(x100)	
Afmetingen (l x b x h)	mm	265 x 142 x 50	
Prijs	€	53,50	

TENGOOLS



Set van 12 schroevendraaiers TX in Teng TTD tray.

Kenmerken:

- Met een ergonomisch zwart-rood twee componenten handvat.

Order nr.	174380105		
Orig. nr.	TTD912TXN		
Schroevendraaiers TX	mm	6(x75) - 7(x75) - 8(x75) - 9(x75) - 10(x100) - 15(x100) - 20(x100) - 25(x100) - 27(x100) - 30(x100) - 40(x100) - 45(x100)	
Afmetingen (l x b x h)	mm	265 x 142 x 50	
Prijs	€	52,50	

TENGOOLS



Set van 7 schroevendraaiers plat, PH en PZ. TT-MV PLUS staal.

Kenmerken:

- Ergonomisch twee componenten handvat met ophanggat.
- TC tray.

Order nr.	174400101		
Orig. nr.	TT917N		
Schroevendraaiers Plat	mm	0,5x3x75 - 1x5,5x75 - 0,2x6,5x100	
Schroevendraaiers PH	mm	0x75 - 1x75 - 2x75	
Schroevendraaiers PZ	mm	2x100	
Prijs	€	27,90	

TENGOOLS



Set van 7 TX/TPX schroevendraaiers.

Kenmerken:

- TT-MV PLUS staal.
- Ergonomisch twee componenten handvat met ophanggat.
- TC tray.

Order nr.	174410100		
Orig. nr.	TT917TXN		
Schroevendraaiers TX	mm	8(x75) - 9(x75)	
Schroevendraaiers TPX	(mm)	10(x100) - 15(x100) - 20(x100) - 25(x100) - 30(x100)	
Afmetingen (l x b x h)	mm	265 x 142 x 50	
Prijs	€	27,50	

TENGOOLS



5-delige schroevendraaierset plat en PH waarvan 2 stubby. TTX-tray.

Order nr.	174500108		
Orig. nr.	TTX918N		
Schroevendraaiers Plat	mm	1,2x6,5x38 - 0,5x3x100 - 1,2x6,5x100 - 1,6x10x200 - 1,0x5,5x150 - 1,2x8x150	
Schroevendraaiers PH	mm	2x38 - 3x150	
Prijs	€	45,50	

TENGOOLS



5-delige set power-thru schroevendraaierset plat en PH met zeskant schacht en slagdop. TTX-tray.

Order nr.	174490102		
Orig. nr.	TTXMDTN		
Schroevendraaiers Plat	mm	1,2x6,5x100 - 1,2x8,0x150 - 1,6x10x200	
Schroevendraaiers PH	mm	2x100 - 3x150	
Afmetingen (l x b x h)	mm	560 x 110 x 40	
Prijs	€	37,50	

TENGOOLS

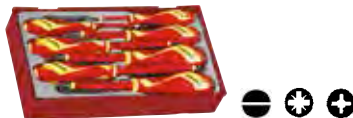

Set van 7 1000V-schroevendraaiers plat, PZ en PH in Teng TC tray.

Bestaande uit:

- 3 platte schroevendraaiers
- 3 PH Schroevendraaiers
- 1 PZ schroevendraaier.

Kenmerken:

- Met geïsoleerde handgreep en schacht.
- TC-tray.

Order nr.	178710109		
Orig. nr.	TTV907N		
Schroevendraaiers Plat	mm	2,5x75 - 4x100 - 5,5x125	
Schroevendraaiers PH	mm	0(x60) - 1(x80) - 2(x100)	
Schroevendraaiers PZ	(mm)	2(x100)	
Afmetingen (l x b x h)	mm	265 x 142 x 50	
Prijs	€	29,50	

TENGOOLS

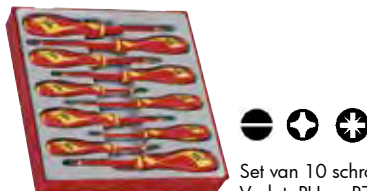

Set van 10 schroevendraaiers 1000-V plat, PH en PZ in TTD tray.

Order nr.	174390104		
Orig. nr.	TTDV910N		
Schroevendraaiers Plat	mm	0,4x2,5x75 - 0,5x3,0x100 - 0,8x4,0x100 - 1,0x5,5x125	
Schroevendraaiers PH		0 - 1 - 2	
Schroevendraaiers PZ		0 - 1 - 2	
Afmetingen (l x b x h)	mm	265 x 142 x 50	
Prijs	€	41,50	

TENGOOLS



Set van 9 Mega Drive schroevendraaiers op dop 6-kant gaande van 5 tot 13mm.

Kenmerken:

- Met een ergonomisch zwart-rood twee componenten handvat.
- TTX-tray.

Order nr.	114590102		
Orig. nr.	TTXMDN		
Maten	mm	5 - 5,5 - 6 - 7 - 8 - 10 - 11 - 12 - 13	
Prijs	€	67,50	

TENGOOLS



Set van 4 Mega Bite tangen.

Bestaande uit:

- 1 waterpomptang 250mm
- 1 zijknijptang 150mm
- 1 lange bektang 200mm
- 1 combinatietang 175mm

Kenmerken:

- Met zwart-rode vinyl-beklede anti-slip handvaten.
- TC-tray.

Order nr.	44280105
Orig. nr.	TT440
Zijknijptang	mm 150
Combinatie tangen	mm 175
Waterpomptangen	mm 250
Lange bektang	mm 200
Prijs	€ 57,90

TENGOOLS



Set van 4 Mega Bite tangen.

Bestaande uit:

- 1 waterpomptang 250mm
- 1 zijknijptang 150mm
- 1 lange bektang 200mm
- 1 combinatietang 175mm.

Kenmerken:

- Met een ergonomisch zwart-rood twee-componenten TPR-handvat.
- TC-tray.

Order nr.	109820101
Orig. nr.	TT440-T
Zijknijptang	mm 150
Combinatie tangen	mm 175
Lange bektang	mm 200
Waterpomptangen	mm 250
Afmetingen (l x b x h)	mm 265 x 142 x 50
Prijs	€ 58,50

TENGOOLS



8-delige tangenset.

Bestaat uit:

- 2 extra zware zijknijptangen
- 2 combinatietangen
- 2 lange bektangen
- 2 waterpomptangen

Kenmerken:

- Met rode vinyl-beklede anti-slip handvat.
- TTD-tray.

Order nr.	174350108
Orig. nr.	TTD441
Zijknijptang	mm 150 - 200
Combinatie tangen	mm 150 - 200
Lange bektang	mm 150 - 200
Waterpomptangen	mm 175 - 250
Afmetingen (l x b x h)	mm 280 x 280 x 50
Prijs	€ 105,00

TENGOOLS



Set van 8 tangen.

Bestaande uit:

- 2 waterpomptangen (175 en 200)
- 2 combinatietangen (150 en 200)
- 2 zijknijptangen (150 en 200)
- 2 platbeektangen (150 en 200).

Kenmerken:

- Chroom-molybdeen staal.
- Ergonomisch twee componenten handvat.
- TTD tray.

Order nr.	174360107
Orig. nr.	TTD441-T
Afmetingen (l x b x h)	mm 280 x 280 x 50
Prijs	€ 115,00

TENGOOLS



Set van 4 geïsoleerde 1000V tangen klasse EN 60900.

Bestaande uit:

- 1 zijknijptang
- 1 lange bektang
- 1 kabelstriiptang
- 1 combinatietang

Kenmerken:

- Geïsoleerde kunststof handgrepen.
- TC-tray.

Order nr.	117490102
Orig. nr.	TTV440
Zijknijptang	mm 150
Combinatie tangen	mm 175
Lange bektang	mm 200
Ontmanteltang	mm 175
Prijs	€ 64,50

TENGOOLS



Set van 4 circlipstangen L.125mm. TC-tray.

Bestaande uit:

- 1 recht inwendig
- 1 recht uitwendig
- 1 gebogen inwendig
- 1 gebogen uitwendig model

Order nr.	112520101		
Orig. nr.	TT474-5		
Circlips tangen	mm	Recht inwendig 10x25 - Gebogen inwendig 10x25 - Recht uitwendig 10x25 - Gebogen uitwendig 10x25	
Prijs	€	40,90	

TENGOOLS



Set van 4 circlipstangen L.175mm. TC-tray.

Bestaande uit:

- 1 recht inwendig
- 1 recht uitwendig
- 1 gebogen inwendig
- 1 gebogen uitwendig model

Order nr.	04030102		
Orig. nr.	TT474-7		
Circlips tangen	mm	recht inwendig 12x65mm - gebogen inwendig 12x65 - recht uitwendig 12x65mm - gebogen uitwendig 12x65mm	
Prijs	€	46,50	

TENGOOLS



Set van 4 circlipstangen L.225mm. TTX-tray.

Bestaande uit:

- 1 recht inwendig
- 1 recht uitwendig
- 1 gebogen inwendig
- 1 gebogen uitwendig model

Order nr.	112700109		
Orig. nr.	TTX474-9		
Tangen circlips recht inwendig	mm	32x80	
Tangen circlips gebogen inwendig	mm	32x80	
Tangen circlips recht uitwendig	mm	32x80	
Tangen circlips gebogen uitwendig	mm	32x80	
Afmetingen (l x b x h)	mm	265 x 142 x 50	
Prijs	€	71,50	

TENGOOLS



Set van 5 griptangen. TC-tray.

Bestaande uit:

- 3 met ronde bek 100, 175 en 250mm
- 2 met lange bek 100 en 150mm

Order nr.	122480106		
Orig. nr.	TTVG05		
Klassieke griptangen	mm	100 - 175 - 250	
Griptangen lange dunne bekken	mm	100 - 150	
Prijs	€	50,90	

TENGOOLS



Set van 4 griptangen.

Bestaande uit:

- 1 C-bek 250mm (type 406)
- 1 platte bek 200mm (type 408)
- 1 gebogen bek 225mm (type 407)
- 1 lange bek type 160mm (type 404).

Geleverd in een PVC tray. PS-tray.

Order nr.	106230105		
Orig. nr.	TTSPSPG		
Prijs	€	55,50	

TENGOOLS



39-delige set.

Bestaande uit:

- 1 moment schroevendraaier 1/4"
- 1 verlengstuk L. 100mm
- 1 bitshouder 1/4"
- 36 verschillende bits.

Nauwkeurigheid +/- 6%.

Order nr.	122500101		
Orig. nr.	TTSD39		
Bitsen	Plat 0,5x3mm - Plat 0,6x4,5mm - Plat 0,8x5,5mm - Plat 1,2x6,5mm - PH0 - PH1 - PH2 - PH3 - PZ0 - PZ1 - PZ2 - PZ3 - TX8 - TX9 - TX10 - TX15 - TX20 - TX25 - TX27 - TX30 - TX40 - TPX10 - TPX15 - TPX20 - TPX30 - TPX40 - Rob 0 - Rob 1 - Rob 2 - Rob 3 - PH GR 2(2) - Hex 2mm - Hex 3mm - Hex 4mm - Hex 5mm - Hex 6mm		
Momentschroevendraaier 1/4"	Nm	1-5	
Hex voor			
Prijs	€	91,50	

TENGTOLS



Set van 1 momentsleutel. Rechtse werking.

Kenmerken:

- Aansluiting 1/2".
- Kracht van 40-120 Nm.
- Richting omkeerbaar d.m.v. hendel maar enkel rechtshandig voor instellen moment.
- In een TTX Tray.

Order nr.	73190100	
Orig. nr.	TTX1292	
Aansluiting	inch	1/2
Capaciteit	Nm	40-200
Prijs	€	63,50

TENGTOLS



Momentsleutel met accessoires in 22-delige set. TTX-tray.

Bestaande uit:

- 1 momentsleutel met rechtse werking en aansluiting 3/8".
- 10 opsteeksleutels.
- 8 bitsen TX.
- 1 bitshouder.
- 2 verlengstukken 3/8" L. 75 en 125mm.

Geleverd in een Teng tray geschikt voor elke Teng gereedschapskoffer of -wagen.

Order nr.	102110104	
Orig. nr.	TTX3892	
Aansluiting	inch	3/8
Bitsen TX		8 · 10 · 15 · 20 · 25 · 27 · 30 · 40
Verlengstukken 3/8"	mm	75 · 125
Opsteeksleutels	mm	10 · 11 · 12 · 13 · 14 · 15 · 16 · 17 · 18 · 19
Bereik	Nm	20-100
Afmetingen (l x b x h)	mm	570 x 110 x 60
Prijs	€	110,00

TENGTOLS



Set. TTX-tray.

Bestaande uit:

- 1 momentsleutel 1/2" 40-210Nm
- 1 krachtvermeerderaar 1/2"/3/4" 1400Nm.

Order nr.	128220100	
Orig. nr.	TTXMP12	
Inkomende aansluiting	inch	1/2
Krachtvermeerderaar	Nm	1400
Momentsleutel 1/2"	Nm	40-200 (max. 200x3 met momentsleutel in deze set)
Uitgaande aansluiting	inch	3/4
Prijs	€	331,00

TENGTOLS



5-delige set. TTX-tray.

Bestaande uit:

- 3 lange slagdoppen 1/2" van 17, 19 en 21mm
- 1 tang 240mm voor montage van balanceergewichten
- 1 momentsleutel 1/2".

Order nr.	122490105	
Orig. nr.	TTXW05	
Momentsleutel 1/2"	Nm	40-210Nm
Tang balanceergewichten	mm	240
Slagdoppen 1/2"	mm	17 · 19 · 21
Afmetingen (l x b x h)	mm	570 x 110 x 40
Prijs	€	102,00

TENGTOLS



24-delige slagdoppenset gaande van 6 tot 19mm. TC-tray.

Bestaat uit:

- 5 korte slagdoppen 1/4"
- 9 korte slagdoppen 3/8"
- 9 lange slagdoppen 3/8"
- 1 adaptor 3/8"-1/4"

Order nr.	132470105	
Orig. nr.	TT9024	
Doppen 3/8"	mm	8 · 10 · 11 · 12 · 13 · 14 · 15 · 16 · 17 · 19
Doppen 1/4"	mm	6 · 7 · 8 · 10 · 13
Doppen 3/8" lang	mm	8 · 10 · 11 · 12 · 13 · 14 · 15 · 16 · 17 · 19
Adaptor	inch	3/8 · 1/4
Prijs	€	58,90

TENGTOLS



Set van 16 slagdoppen. TC-tray.

Bestaat uit:

- 16 korte en lange slagdoppen 1/2" gaande van 13 tot 24mm
- 2 vasthoudpinnen
- 2 O-ringen

Conform DIN-standaard.

Order nr.	143840106	
Orig. nr.	TT9120D	
Doppen 1/2" 6-kant	mm	13 · 15 · 16 · 17 · 18 · 19 · 22 · 24
Doppen 1/2" 6-kant lang	mm	13 · 15 · 16 · 17 · 18 · 19 · 22 · 24
Vasthoudpinnen	mm	20X3,5 · 25X3,5
O-ringen	mm	3x20 · 3x24
Prijs	€	79,50

TENGOOLS



16-delige korte en lange doppenset 1/2" ANSI gaande van 13 tot 24mm. TC-Tray.

Order nr.	68800101		
Orig. nr.	TT9116		
Doppen 1/2"	mm	13 - 15 - 16 - 17 - 18 - 19 - 22 - 24	
Doppen 1/2" lang	mm	13 - 15 - 16 - 17 - 18 - 19 - 22 - 24	
Prijs	€	58,50	

TENGOOLS



Set van 15 hex slagdoppen 3/8" en 1/2" gaande van 4 tot 19mm. TC-tray.

Order nr.	151410107		
Orig. nr.	TT9015HX		
Dopbitsen 1/2" Hex	mm	5 - 6 - 8 - 10 - 12 - 14 - 17 - 19	
Dopbitsen 3/8" hex	mm	4 - 5 - 6 - 7 - 8 - 10 - 12	
Afmetingen (l x b x h)	mm	265 x 142 x 50	
Prijs	€	100,00	

TENGOOLS



Set van 12 slagdopbitsen 1/2" gaande van TX10 tot TX70. TC-tray.

Order nr.	128130101		
Orig. nr.	TT9212TX		
Slagbitsen	TX	10 - 15 - 20 - 25 - 27 - 30 - 40 - 45 - 50 - 55 - 60 - 70	
Prijs	€	92,90	

TENGOOLS



7-delige set slagdopaccessoires 1/2". TC-tray.

Bestaande uit:

- 3 verlengstukken
- universele elleboog 1/2"
- 3 adaptors

Order nr.	132460106		
Orig. nr.	TT9207		
Verlengstukken	mm	75 - 125 - 250	
Universele koppeling	inch	1/2	
Adaptors	inch	1/23/4 - 3/8-1/2 - 1/23/8	
Prijs	€	52,90	

TENGOOLS

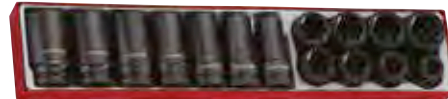

Set van 15 korte en lange slagdoppen 3/4" gaande van 19 tot 36mm. TTX-tray.

Order nr.	122080104		
Orig. nr.	TTX9415		
Slagdoppen 3/4"	mm	19 - 24 - 27 - 28 - 30 - 32 - 34 - 36	
Slagdoppen 3/4" lang	mm	19 - 24 - 27 - 30 - 32 - 33 - 36	
Prijs	€	170,00	

TENGOOLS



16-delige slagdoppenset. TC-tray.

Bestaat uit:

- 9 korte slagdoppen gaande van 19 tot 38mm
- 1 verlengstuk

Order nr.	160690103		
Orig. nr.	TTD9416		
Doppen 3/4" 6-kant	mm	19 - 24 - 27 - 30 - 32 - 33 - 34 - 36 - 38	
Verlengstuk	mm	175	
Vasthoudpinnen	mm	4x37 (x2)	
O-ringen	mm	38x3,5 (x3)	
Afmetingen (l x b x h)	mm	260 x 280 x 80	
Prijs	€	110,00	

TENGOOLS



Slagmoersleutel.

Kenmerken:

- Lichte slagmoersleutel met geluidsabsorberend vermogen
- Motorbehuizing uit composiet materiaal
- Ergonomisch rubberen handvat, geïsoleerd tegen kou en trillingen
- 360° draaibare slangaansluiting
- Omkeerbaar - 3 snelheden vooruit en 2 achteruit
- Ontsnappen van de lucht door het handvat, ver van de gebruiker
- Traploze trekker
- Twin hammer mechanisme voor een hoog koppel en een goed uitgebalanceerd aandraaien en losmaken
- Vierkante verbinding met ringslot voor slagdoppen

Geschikt voor professionele werkplaatsen.

Order nr.	168840106		
Orig. nr.	TTDAW12C		
Snelheid onbelast	tpm	8500	
Geluidsniveau	dB(A)	97,5	
Vibratie	m/s ²	4,42	
Boutcapaciteit	mm	M8-M16	
Maximum torsie	Nm	720	
Minimum maat slang	inch	3/8	
Luchtaansluiting	G (R)	1/4	
Luchtverbruik (bij 15% interval)	l/min	133	
Type hamermechanisme	twin hammer		
Prijs	€	218,00	

TENGOOLS



20-delige set. TC-tray.

Bestaande uit:

- 1 slagschroevendraaier 1/2"
- bitshouder 1/2"-5/16"
- adaptor 3/8" M-5/16" Hex
- 17 slagbitsen L.36mm

Order nr.	102100104
Orig. nr.	TTID20
Slagbitsen Plat	mm 6 - 8 - 10 - 12
Slagbitsen PH	1 - 2 - 3 - 4
Adaptor	inch 3/8-5/16
Slagbitsen Hex	mm 4 - 5 - 6 - 8
Slagbitsen TX	30 - 40 - 45 - 50 - 55
Prijs	€ 27,50

TENGOOLS



4-delige set. TC-tray.

Bestaande uit:

- 1 schraper
- 1 priem
- 2 haken

Met een ergonomisch twee componenten handvat.

Order nr.	117690107
Orig. nr.	TTSR04
Prijs	€ 25,50

TENGOOLS



Set van 3 speciale klemtangen voor het onbeschadigd samenklappen van o.a. remleidingen.

Kenmerken:

- Lichte constructie.
- Toepasbaar voor de meest gangbare leidingen.
- TC-tray.

Order nr.	118420108
Orig. nr.	TTHC03
Aantal stuks	3
Voor slang diameter	mm 10 - 15 - 30
Prijs	€ 27,50

TENGOOLS



5-delige hamerset. PS-tray.

Bestaande uit:

- 2 terugslagvrije hamers
- 3 plaatwerkhamers.

Geleverd in een PVC tray.

Order nr.	122440100
Orig. nr.	TTPSAD
Diameter kop van terugslagvrije hamers	mm 35 & 55
Plaatwerkhamer	met rechte pin, met ronde puntige kop, met vierkante kop
Gewicht	kg 5,76
Prijs	€ 105,00

TENGOOLS



121-delige set. TC-tray.

Bestaande uit:

- 1 kabelschoentang CP50 voor geïsoleerde kabelschoentjes (rode, blauwe en gele)
- assortiment van 120 kabelschoentjes

Order nr.	110380102
Orig. nr.	TTCP121
Prijs	€ 25,90

TENGOOLS



4-delige set. TC-tray.

Bestaande uit: 1 automatische kabelschoentang met 3 klauwen voor respectievelijk

- geïsoleerde 22-10 AWG
- niet-geïsoleerde 22-12 AWG
- niet-geïsoleerde 22-8 AWG kabelschoenen

Order nr.	122470107
Orig. nr.	TTCP04
Voor geïsoleerde kabelschoenen	mm 22-10 AWG (0,324 mm ² - 5,261 mm ²)
Voor niet geïsoleerde ADENER-hulzen	mm 22-12 AWG (0,324 mm ² - 3,31 mm ²)
Voor niet-geïsoleerde kabelschoenen	mm 22-8 AWG (0,3 mm ² - 8 mm ²)
Prijs	€ 60,50

TENGOOLS



Set van 12 naaldvlijen met de meeste courante modellen.

Kenmerken:

- TC-tray.
- Lengte 163mm.

Order nr.	128430105
Orig. nr.	TTNF12
Prijs	€ 26,90

TENGOOLS



4-delige set.

Bestaande uit:

- 1 combinatie-poulietrekker met 3 armen.

Kenmerken:

- Met de mogelijkheid om de poulietrekker zowel als 2-armig of als 3-armig toestel te gebruiken.
- Met omkeerbare armen voor intern en extern trekken.
- TC-tray.

Order nr.	03980109
Orig. nr.	TT804
Vastklemdiepte	mm 100
Vastklembreedte	mm 130
Prijs	€ 39,50

TENGOOLS



Set van 3 koevoeten. TTX-tray.

Kenmerken:

- Koevoeten van verschillende lengtes en met een ronde, spitse punt aan het ene eind en een vlakke ronde haak aan het andere einde.

Order nr.	100690106
Orig. nr.	TTXPB3
Lengte	mm 300 - 400 - 500
Prijs	€ 50,50

TENGOOLS



Set van 3 priemen voorzien van een stevig handvat.

Kenmerken:

- Universeel toepasbaar.
- TTX-tray.

Order nr.	117860106
Orig. nr.	TTXPB3A
Lengte	mm 300 - 450 - 550
Prijs	€ 36,90

TENGOOLS



16-delige universele olieserviceset. TC-tray.

Bestaande uit:

- 6 dubbele carterdoppen
- 2 bougiedoppen 3/8"
- 1 oliefiltersleutel
- 2 verlengstukken 3/8" L. 75 en 200mm
- 1 adaptor 1/2"-3/8"
- 1 dop 3/8" 21 mm
- 1 telescopische inspectiespiegel met magneet
- een set voelermaten

Order nr.	03960101
Orig. nr.	TTOS16
Aantal stuks	16
Maat carterdoppen	mm/pouce 5/16x3/8 - 11x12 - 17x1/2 - 8x3/8 - 8x10 - 13x14
Bougiedoppen 3/8"	mm 16 - 21
Verlengstukken 3/8"	mm 75 - 250
Voelermaat, 21 bladen	mm 0,05 - 1,00
Prijs	€ 58,50

TENGOOLS



11-delige set. TC-tray.

Bestaande uit:

- 5 linkse tappen
- 4 moeren-extracteurs
- 2 moersplijters

Order nr.	69340107
Orig. nr.	TTSN11
Linkse tappen	inch 7/64 - 9/64 - 5/32 - 1/4 - 19/64
Extractors	mm 6 - 8 - 10 - 12
Moersplijters	mm 5-20, 14-27
Prijs	€ 60,90

TENGOOLS



17-delige tappen- en snijkussenset. TC-tray

Bestaat uit:

- 6 tappen en 6 snijkussens gaande van M3 tot M12
- 1 kussenhouder
- 1 taphouder
- 1 draadsnijmeter

Order nr.	69190106
Orig. nr.	TTTD17
Maten	M3 - M4 - M5 - M6 - M8 - M10 - M12
Type tap	Handtap
Prijs	€ 44,90

TENGOOLS



10-delige flensboordset. TC-tray.

Kenmerken:

- Geschikt voor koperen, bronzen en dunwandige alu-buizen.
- Snijscapaciteit tot 30mm.
- 45° boorden van 3/16" tot 5/8" diam.
- Inclusief wisselmes en hendel.

Order nr.	144040102		
Orig. nr.	TTTF10		
Buizensnijder	mm	3 - 32	
Flensboord tool	mm	3 - 4 - 5 - 6 - 8 - 10	
Flensboord adaptors voor buizendiameter	mm	4 - 4,75 - 6 - 8 - 10 - 12 - 14	
Afmetingen (l x b x h)	mm	265 x 142 x 50	
Prijs	€	58,90	

TENGOOLS



Knipset. TTD-tray.

Bestaande uit:

- 2 plaatscharen (recht/rechts (491) - recht/links (492))
- een breekmes (701N)
- een schaar (497)
- een extra-zware kabelknijptang (496 - 590mm)

Order nr.	144020104		
Orig. nr.	TTDCT05		
Prijs	€	71,90	

TENGOOLS



Set met 5 breekmessen en 35 vervangmessen. TC-tray.

Order nr.	174480103		
Orig. nr.	TTK40		
Afmetingen (l x b x h)	mm	270 x 143 x 50	
Prijs	€	41,90	

TENGOOLS



81-delige blindnietmoertangset. TC-tray.

Bestaande uit:

- 1 blindnietmoertang (cap. M3, M4, M5 en M6)
- een assortiment van 80 (4x20) blindnietmoeren

Order nr.	106190101		
Orig. nr.	TTNR81		
Afmetingen (l x b x h)	mm	265 x 142 x 50	
Prijs	€	97,90	

TENGOOLS



81-delige riveteertangset. TC-tray.

Bestaande uit:

- 1 riveteertang (cap. 2,4 - 3,2 - 4,0 - 4,8mm)
- een assortiment van 80 (4x20) blindrivetten.

Order nr.	69210102		
Orig. nr.	TTHR81		
Lengte	mm	250	
Afmetingen (l x b x h)	mm	270 x 143 x 50	
Prijs	€	50,50	

TENGOOLS



3-delige inspectieset met telescopische werktuigen. TC-tray.

Bestaande uit:

- 1 inspectiespiegel
- 1 vergrootglas
- 1 magneet

Alle 3 met een cliphouder/zakklem.

Order nr.	109460105		
Orig. nr.	TTTM03		
Diameter magneet	mm	12	
Diameter vergrootglas/spiegel	mm	55	
Gewicht	kg	0,22	
Afmetingen (l x b x h)	mm	265 x 142 x 50	
Prijs	€	37,50	

TENGOOLS



8-delige inspectieset. TC-tray.

Bestaande uit:

- Telescopische pick-up werktuigen zoals 1 flexibele klauw en 1 telescopische pick up
- 1 inspectiespiegel
- 1 vergrootglas
- 1 LED lamp model 585

Geleverd met 2 batterijen.

Order nr.	144370103		
Orig. nr.	TTTM08		
Lengte flexibele pickup	mm	310	
Lengte telescopische pickup	mm	160-480	
Gewicht	kg	0,81	
Afmetingen (l x b x h)	mm	265 x 142 x 50	
Prijs	€	50,50	

TENGOOLS



Set van 5 handvijen. TTX Tray. L. 250mm middelgrof.

Bestaande uit:

- 1 ronde
- 1 halfronde
- 1 vierkante
- 1 driehoek
- 1 platte handvijl.

Order nr.	128440104
Orig. nr.	TTXF05
Prijs	€ 42,90

TENGOOLS



9-delige beitel- en doorslagenset. TC-tray.

Bestaande uit:

- 2 beitels L. 150 en 200mm
- 6 doorslagen diam. 3 tot 8mm
- 1 centerpunt L. 150mm

Order nr.	69220101
Orig. nr.	TTPC09
Top diameter doorslagen	mm 3 - 4 - 5 - 6 - 7 - 8
Breedte beitels	mm 19 - 25
Punt diameter centerdoorslag	mm 5
Afmetingen (l x b x h)	mm 270 x 143 x 50
Prijs	€ 41,90

TENGOOLS



28-delige borenset 1-13mm per 0,5mm.

Kenmerken:

- DIN 338 HSS.
- Sniijhoek 118°.
- Bestaande uit: 3 x 1.0 en 1.5mm/ 2 x 2.0 en 2.5mm/ 1 x 3mm tot 13mm.
- TC-tray.

Order nr.	151440104
Orig. nr.	TTDB28
Aantal stuks	28
Boordiameter	mm 1,0 - 13,0
Afmetingen (l x b x h)	mm 270 x 143 x 50
Prijs	€ 44,90

TENGOOLS



Torsiestaafset in TC-tray. Voor het vastzetten van wielmoeren.

Bevat:

- 4 torsiestaven variërend van 90-140 Nm
- 1 adaptor
- 3 slagdoppen voorzien van een kunststof beschermingshuls voor gebruik bij o.a. alu-velgen.

Order nr.	172470403
Orig. nr.	TTTS08
Adaptor	inch 3/8 x 1/2
Verlengstukken	Nm 1/2" 90-110-120-140
Doppen 1/2"	mm 17-19-21
Prijs	€ 76,50

TENGOOLS



5-delige meetset. TC-tray.

Bestaande uit:

- digitale schuifmaat 150 mm
- micrometer 0-25 mm
- winkelhaak 150x100 mm
- stalen maatlat 150 mm
- kraspen 135 mm.

Geleverd zonder batterijen (1x SR44).

Order nr.	167500206
Orig. nr.	TTCM05D
Aantal stuks	5
Digitale schuifmaat	mm 0-150
Micrometers	mm 0-25
Winkelhaak	mm 150x100
Maatlat	mm 150
Kraspen	mm 135
Afmetingen (l x b x h)	mm 265 x 142 x 50
Prijs	€ 111,00

TENGOOLS



5-delige set van flex-bougiedoppen 3/8".

Kenmerken:

- Met opening voor T-hendel.
- Met T-baar.
- TTX-tray.

Order nr.	178801007
Orig. nr.	TTXTB05
Doppen 3/8"	mm 14 - 16 - 21
Handvat lengte	mm 520
Afmetingen (l x b x h)	mm 560 x 110 x 40
Prijs	€ 61,50

TENGOOLS



Buizensnijderset 6-delig.

Bestaat uit:

- buitensnijders voor koper en bronzen buizen 10, 12, 15 en 22mm, 3-22mm
- Ontbraamtoestel

Order nr.	186400107
Orig. nr.	TTTC06
Buizensnijder	mm 10 - 12 - 15 - 22
Verstelbare buizensnijder	mm 3-22
Prijs	€ 71,90

Gereedschap in EVA foam trays

TENGTTOOLS



63-delige doppenset 1/2" 8-36mm en accessoires. EVA-tray.

Order nr.	161670104	
Orig. nr.	TTESK63	
Aantal stuks	63	
Verlengstukken 1/2"	mm	63 - 125 - 150 - 250 - 500
Doppen 1/2" 12-kant	mm	8 - 9 - 10 - 11 - 12 - 13 - 14 - 15 - 16 - 17 - 18 - 19 - 20 - 21 - 22 - 24 - 25 - 26 - 27 - 28 - 29 - 30 - 32 - 34
Doppen 1/2" 12-kant lang	mm	10 - 11 - 12 - 13 - 14 - 15 - 16 - 17 - 18 - 19 - 20 - 21 - 22 - 24 - 27 - 30 - 32 - 36
Verlengstukken met bolkop 1/2"	mm	75 - 150 - 250
Flex hendel	mm	250
Aantal tanden ratel 1/2"		60
Afmetingen (l x b x h)	mm	568 x 374 x 32
Prijs	€	280,00

TENGTTOOLS



86-delige doppenset 1/4" en 3/8" 4-22mm en accessoires. EVA-tray.

Order nr.	161680103	
Orig. nr.	TTESK86	
Aantal stuks	86	
Verlengstukken 3/8"	mm	75 - 125 - 150 - 250 - 500
Doppen 1/4"	mm	4 - 4,5 - 5 - 5,5 - 6 - 7 - 8 - 9 - 10 - 11 - 12 - 13
Doppen 1/4" 6-kant lang	mm	4 - 5 - 5,5 - 6 - 7 - 8 - 9 - 10 - 11 - 12 - 13
Doppen 3/8" 6-kant	mm	7 - 8 - 9 - 10 - 11 - 12 - 13 - 14 - 15 - 16 - 17 - 18 - 19 - 20 - 21 - 22
Doppen 3/8" 6-kant lang	mm	7 - 8 - 9 - 10 - 11 - 12 - 13 - 14 - 15 - 16 - 17 - 18 - 19 - 20 - 21 - 22
Verlengstukken 1/4"	mm	50 - 75 - 100 - 150 - 300
Verlengstukken met bolkop 3/8"	mm	75 - 150 - 250
Aantal tanden ratels 1/4" en 3/8"		60
Afmetingen (l x b x h)	mm	568 x 374 x 32
Prijs	€	273,00

TENGTTOOLS



77-delige doppenset (1/4", 3/8" en 1/2").

Kenmerken:

- Geleverd in een nieuw Teng Tools opslagsysteem in twee kleuren EVA verzonken schuim.
- Geschikt voor Teng Tools boxes en gereedschapswagens.

Order nr.	178840104	
Orig. nr.	TTESK77	
Aantal stuks	77	
Doppen 1/4" 6-kant lang	mm	6 - 7 - 8 - 10 - 12 - 13
Doppen 3/8" 6-kant	mm	8 - 9 - 10 - 11 - 12 - 13 - 14 - 15 - 16 - 17 - 18 - 19 - 22
Verlengstukken met bolkop 3/8"	mm	75 - 150
Doppen 1/2" 12-kant	mm	10 - 11 - 12 - 13 - 14 - 15 - 16 - 17 - 18 - 19 - 22
Verlengstukken met bolkop 1/2"	mm	150 - 250
Slagdoppen 1/2"	mm	13 - 15 - 16 - 17 - 18 - 19 - 22 - 24
Slagdoppen 1/2" lang	mm	13 - 15 - 16 - 17 - 18 - 19 - 22 - 24
Ratel 45 tanden		1/4" - 3/8" - 1/2"
Universele verbindingen		1/4" - 3/8" - 1/2"
Adaptors (reductie)		3/8"-1/4" - 1/2"-3/8"
Adaptor (vergroter)		3/8"-1/2"
Spinner handvatten		1/4" - 3/8"
Verlengstukken 1/4", lengte	mm	150 - 300
Doppen 1/4" 6-kant	mm	4 - 5 - 5,5 - 6 - 7 - 8 - 9 - 10 - 11 - 12 - 13
T-handvatten		1/4"
Afmetingen (l x b x h)	mm	570 x 375 x 75
Prijs	€	282,00

TENGOOLS



32-delige doppenset en accessoires 3/4" 19-50mm. EVA-tray.

Order nr.	161730106 ⓘ	
Orig. nr.	TTESK32	
Aantal stuks	32	
Verlengstuk 3/4"	mm	400
Doppen 3/4"	mm	19 - 21 - 22 - 24 - 27 - 30 - 32 - 33 - 34 - 36 - 38 - 41 - 46 - 50
Doppen 3/4"	inch	7/8 - 15/16 - 1 - 1 1/16 - 1 1/8 - 1 3/16 - 1 1/4 - 1 5/16 - 1 3/8 - 1 7/8 - 1 1/2 - 1 5/8 - 1 3/4 - 1 7/8
T-baar 3/4"	mm	450
Flex hendel 3/4"	mm	475
Aantal tanden ratel 3/4"	60	
Afmetingen (l x b x h)	mm	568 x 374 x 32
Prijs	€	362,00

TENGOOLS



Doppen en bitsset 85dlg. EVA-tray.

Order nr.	178850103 ⓘ	
Orig. nr.	TTESK85	
Aantal stuks	85	
Bitsen TX 1/2"	20 - 25 - 27 - 30 - 40 - 50 - 55 - 60	
Bitsen Plat 1/4"	mm	4 - 5,5 - 7
Bitsen TX-E 3/8"	10 - 12 - 14 - 16 - 18	
Verlengstuk 3/8"	mm	75
Bitsen Hex 1/2"	mm	5 - 6 - 7 - 8 - 10 - 12
Bitsen RIB 1/2"	4 - 5 - 6 - 8 - 10 - 12 - 13	
Bitsen SPL 1/2"	5 - 6 - 8 - 10 - 12 - 14 - 16	
Bitsen PH 1/4"	0 - 1 - 2 - 3	
Bitsen PZ 1/4"	1 - 2 - 3	
Bitsen TX-E 1/4"	4 - 5 - 6 - 7 - 8	
Bitsen TX 1/4"	10 - 15 - 20 - 25 - 27 - 30 - 40	
Bitsen TPX 3/8"	10 - 15 - 20 - 25 - 27 - 30 - 40 - 45 - 50	
Bitsen TX 3/8"	10 - 15 - 20 - 25 - 27 - 30 - 40 - 45 - 50	
Bitsen Hex 3/8"	mm	3 - 4 - 5 - 5,5 - 6 - 7 - 8 - 10 - 12
Afmetingen (l x b x h)	mm	570 x 375 x 50
Prijs	€	220,00

TENGOOLS



73-delige slagdoppenset 1/2" 8-32mm en accessoires. EVA-tray.

Order nr.	161690102 ⓘ	
Orig. nr.	TTEISK73	
Aantal stuks	73	
Slagdoppen 1/2" 6-kant	mm	8 - 10 - 11 - 12 - 13 - 14 - 15 - 16 - 17 - 18 - 19 - 20 - 21 - 22 - 23 - 24 - 25 - 26 - 27 - 28 - 29 - 30 - 32
Slagdoppen 1/2" 6-kant lang	mm	10 - 11 - 12 - 13 - 14 - 15 - 16 - 17 - 18 - 19 - 21 - 22 - 24 - 27 - 28 - 29 - 30 - 32
Slagdoppen 3/8" 6-kant	mm	8 - 10 - 11 - 12 - 13 - 14 - 15 - 16 - 17 - 19
Slagdoppen 3/8" 6-kant lang	mm	8 - 10 - 11 - 12 - 13 - 14 - 16 - 17 - 19
Verlengstukken 1/2"	mm	75 - 125 - 250
Verlengstukken 3/8"	mm	75 (swivel)
Adaptors	inch	3/8-1/4 - 3/8-1/2 - 1/2-3/8 - 1/2-3/4
Bitshouder 1/4"	inch	3/8 - 1/2
Afmetingen (l x b x h)	mm	568 x 374 x 32
Prijs	€	380,00

TENGOOLS



33-delige slagdoppenset en accessoires 3/4" 19-50mm. EVA-tray.

Order nr.	161700109 ⓘ	
Orig. nr.	TTEISK33	
Aantal stuks	33	
Adaptors	inch	3/4-1/2 - 3/4-1
Slagdoppen 3/4"	mm	19 - 21 - 22 - 23 - 24 - 27 - 28 - 30 - 32 - 33 - 34 - 36 - 38 - 41 - 46 - 50
Slagdoppen 3/4" lang	mm	19 - 21 - 22 - 23 - 24 - 27 - 30 - 32 - 33 - 34 - 36 - 38 - 41 - 46 - 50
Verlengstuk 3/4"	mm	175
Afmetingen (l x b x h)	mm	568 x 374 x 32
Prijs	€	460,00

TOOLS

TENGTOOLS



Set van 17 tangen. EVA-tray.

Order nr.	161720107	
Orig. nr.	TTEMB17	
Aantal stuks	17	
Zijkniptangen	mm	125 - 150
Zijknip heavy duty tangen	mm	150 - 200 (15°)
Kabelniptangen	mm	200
Combinatietangen	mm	175 - 200
Waterpomptangen	mm	175 - 200
Ontmanteltangen	mm	175
Bektangen	mm	150
Circlips recht inwendig	mm	175
Circlips gebogen inwendig	mm	175
Circlips recht uitwendig	mm	175
Circlips gebogen uitwendig	mm	175
Afmetingen (l x b x h)	mm	568 x 374 x 32
Prijs	€	242,00

TENGTOOLS



Tangenset 11dlg EVA-tray.

Set bestaande uit:

- Extra zware zijknijptang (MB442-8T)
- Griptang 100mm (401-4), 250mm (401-10), met lang dun bekken 160mm (404-6)
- Combinatietang 175mm (MB452-7T)
- Lange recht bektang 200mm (MB461-8T)
- Circlipstang 170mm inwendig recht (MB470-7), gebogen (MB471-7), uitwendig recht (MB472-7), gebogen (MB473-7)
- Waterpomptang 250mm (MB481-10T)

Order nr.	178810107	
Orig. nr.	TTEMB11	
Afmetingen (l x b x h)	mm	570 x 375 x 32
Prijs	€	148,00

TENGTOOLS



11-delige griptangenset gaande van 4" tot 12". EVA-tray.

Order nr.	161760103	
Orig. nr.	TTEVG11	
Aantal stuks	11	
Universele griptangen 401	mm	100 - 125 - 250 - 300
Griptangen voor het lassen 406P	mm	280
Universele griptangen 401F	mm	250 - 300
Universele griptangen 404	mm	100 - 155 - 230
Griptangen voor het lassen 409P	mm	300
Afmetingen (l x b x h)	mm	568 x 374 x 32
Prijs	€	171,00

TENGTOOLS



62-delige doppen en steekringsleutel set. EVA-tray.

Order nr.	172320103	
Orig. nr.	TTEAF62	
Steekringsleutels	mm	5/16, 3/8, 7/16, 1/2, 9/16, 5/8, 11/16, 3/4, 13/16, 7/8, 15/16, 1, 11/16, 11/8, 1 1/4
Doppen 1/4" kort	inch	3/16, 7/32, 1/4, 9/32, 5/16, 11/32, 3/8, 7/16, 1/2
Doppen 1/4" lang	inch	3/16, 7/32, 1/4, 9/32, 5/16, 11/32, 3/8, 7/16, 1/2
Doppen 3/8" kort	inch	3/8, 7/16, 1/2, 9/16, 5/8, 11/16, 3/4
Doppen 3/8" lang	inch	3/8, 7/16, 1/2, 9/16, 5/8, 11/16, 3/4
Doppen 1/2" kort	inch	3/8, 7/16, 1/2, 9/16, 5/8, 11/16, 3/4, 13/16, 7/8, 15/16, 1, 11/8, 13/16, 1 1/4
Afmetingen (l x b x h)	mm	568 x 374 x 32
Prijs	€	225,00

TENGOOLS



37-delige ring-, steek-, ratel-, sleutelset. 6-32mm. EVA-tray.

Order nr.	161740105		
Orig. nr.	TTESP37		
Aantal stuks	37		
Steeksleutels	mm	6x7 - 8x9 - 10x11 - 12x13 - 14x15 - 16x17 - 18x19 - 20x22 - 21x23 - 24x27 - 30x32	
Ringsleutels	mm	6x7 - 8x9 - 10x11 - 12x13 - 14x15 - 16x17 - 18x19 - 20x22 - 21x23 - 24x27 - 30x32	
Ratel-steekringsleutels	mm	8 - 9 - 10 - 11 - 12 - 13 - 14 - 15 - 16 - 17 - 18 - 19 - 22 - 24 - 27	
Afmetingen (l x b x h)	mm	568 x 374 x 32	
Prijs	€	450,00	

TENGOOLS



31-delige steekringsleutelset 5,5-38mm. EVA-tray.

Order nr.	161750104		
Orig. nr.	TTESP31		
Steekringsleutels	mm	5,5 - 6 - 7 - 8 - 9 - 10 - 11 - 12 - 13 - 14 - 15 - 16 - 17 - 18 - 19 - 20 - 21 - 22 - 23 - 24 - 25 - 26 - 27 - 28 - 29 - 30 - 32 - 33 - 34 - 36 - 38	
Aantal stuks	31		
Afmetingen (l x b x h)	mm	568 x 374 x 32	
Prijs	€	282,00	

TENGOOLS



Sleutel en vijlenset 32dlg EVA-tray.

Bestaande uit:

- 12 steekringsleutels 8 tot 32mm
- 15 platte steekringsleutels 8 tot 19mm
- 5 vijlen L 250mm

Order nr.	178870101		
Orig. nr.	TTEX32		
Steekringsleutels	mm	8 - 9 - 10 - 11 - 12 - 13 - 14 - 15 - 16 - 17 - 18 - 19 - 20 - 21 - 22 - 24 - 27 - 30 - 32	
Vijlen	middelgrof: plat (2), half rond, rond en driehoek		
Platte steekringsleutels	mm	8 - 10 - 11 - 12 - 13 - 14 - 17 - 19	
Afmetingen (l x b x h)	mm	570 x 375 x 32	
Prijs	€	241,00	

TENGOOLS

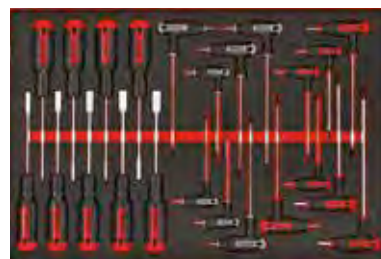

23-delige T-allensleutelset. EVA-tray.

Order nr.	166810101		
Orig. nr.	TTEX23		
Aantal stuks	23		
Sleutels TX	mm	10 - 15 - 20 - 25 - 27 - 30 - 40	
Schroevendraaiers op dop	mm	5 - 5,5 - 6 - 7 - 8 - 10 - 11 - 12 - 13	
Sleutels Hex	mm	2,5 - 3 - 4 - 5 - 6 - 7 - 8	
Afmetingen (l x b x h)	mm	568 x 374 x 32	
Prijs	€	150,00	

TENGTOLS



122-delige schroevendraaier- en bitsset. EVA-tray.

Order nr.	186200101	
Orig. nr.	TTEMD122N	
Aantal stuks	122	
Schroevendraaiers Plat	mm	2,5x75 - 3,5x75 - 3x100 - 4x100 - 5,5x75 - 5,5x150 - 6,5x38 (Stubby) - 6,5x100 - 6,5x150 - 8x150 - 10x200
Schroevendraaiers PH	mm	0x75 - 1x75 - 1x38 (Stubby) - 2x38 (Stubby) - 2x100 - 3x150 - 4x200
Bitsen Plat 25mm	mm	0,6x3,5 - 0,6x4,5 - 0,8x4 (2x) - 0,8x5,5 (2x) - 1,2x6,5 - 1,6x8
Bitsen Plat 50mm	mm	0,6x3,5 (3x) - 0,8x4 (3x) - 0,8x5,5 (3x) - 1,0x5,5 (3x) - 1,2x6,5 (3x)
Schroevendraaiers PZ	mm	0x75 - 1x100 - 1x38 (Stubby) - 2x38 (Stubby) - 2x100 - 2x150 - 3x150
Bitsen PH 25mm		1 - 2 - 3
Bitsen PZ 25mm		1 - 2 - 3
Bitsen TX 25mm		6 - 7 - 8 - 9 - 10 - 15 - 20 (3x) - 25 (3x) - 27 - 30 - 40
Bitsen TPX 25mm		10 - 15 - 20 (2x) - 25 (2x) - 27 - 30 - 40
Bitsen Hex 25mm	mm	2 - 3 - 4 - 5 - 6 - 8
Bitsen GR 25mm		2 (3x)
Bitsen PH 50mm		1 (3x) - 2 (6x) - 3 (3x)
Bitsen PZ 50mm		1 (2x) - 2 (2x) - 3
Bitsen 50mm TX		8 (3x) - 10 (6x) - 15 (3x) - 20 (6x) - 25 (6x) - 27 (3x) - 30 (3x)
Bitsen Hex 50mm	mm	4 (3x) - 5 (3x) - 6 (3x) - 8 (3x)
Afmetingen (l x b x h)	mm	570 x 375 x 75
Prijs	€	183,00

TENGTOLS



Set van 98 schroevendraaiers en bitsen.

Kenmerken:

- Geleverd in een tray met EVA schuim.
- Geschikt voor Teng Tools koffers en gereedschapswagens.

Order nr.	186160107	
Orig. nr.	TTEMD98N	
Schroevendraaiers TX		8 - 9
Schroevendraaiers TPX	TPX	10 - 15 - 20 - 25 - 30
Schroevendraaiers met doorgaande schacht plat	mm	6,5x100 - 8x150 - 10x200
Schroevendraaiers PH met doorgaande schacht		2x100 - 3x150
Geïsoleerde schroevendraaiers Plat	mm	2,5x75 4x100 5,5x125
Geïsoleerde schroevendraaiers PH		0x60 - 1x80 - 2x100
Geïsoleerde schroevendraaiers PZ		2x100
Bitsen lengte 25 mm, plat	mm	0,6x3,5 - 0,6x4,5 - 0,8x4,0 (x 2) - 0,8x5,5 - 1,0x5,5 (x 2) - 1,2x6,5 - 1,6x8,0
Bitsen GR PH lengte 25 mm	PH	2 (x3)
Bitsen lengte 25 mm voor int. hex gaten	mm	2 - 3 - 4 - 5 - 6 - 8
Bitsen PH lengte 25 mm	PH	1 (x3) - 2 (x3) - 3 (x3)
Bitsen PZ lengte 25 mm		3 (x3) - 2 (x3) - 3 (x4)
Prijs	€	170,00

NEW**EVA foam trays
in formaat van TTX & TTD Trays**zie www.vynckier.biz**Gef organised™**

TOOLS

TENGTOOLS

17-delige hex sleutel en inspectieset EVA-tray.

Set bestaande uit:

- Momentsleutel 1/2 200nM
- TX sleutelset 8dlg 1477NX
- Allensleutelset 9 dlg 1479MM
- TX sleutelset 9dlg 1479TX
- Allensleutel bolkop 7mm
- Allensleutel 2.5 - 8mm
- Inspectieset 4dlg
- Haak en pinnenset 4dlg

Order nr.	178860102	
Orig. nr.	TTEX17	
Aantal stuks	17	
Afmetingen (l x b x h)	mm	570 x 375 x 32
Prijs	€	187,00

TENGTOOLS

Basistoolset 12dlg EVA-tray.

Bestaande uit:

- Schroefleutel 150x250mm
- Metaal beugelzaag
- Breekmes
- Beitel 150 en 200mm
- Centerpunt 150x5mm
- Hamer 800gr
- Hamer met nylon en rubber kop
- Rolmeter 3m
- 6 dlg doorslagset
- Maatlat metaal 200mm

Order nr.	178830105	
Orig. nr.	TTEPS12	
Afmetingen (l x b x h)	mm	570 x 375 x 32
Prijs	€	152,00

Gereedschap in muurrekken



Set van 6 dubbele flex-ringsleutels 12-kant.

Kenmerken:

- Gaande van 8 tot 19mm.
- Geleverd met een wandrek voor montage op een muur of wandpaneel.

Order nr.	128230109		
Orig. nr.	WRDF06		
Kniesleutels	mm	8x9 · 10x11 · 12x13 · 14x15 · 16x17 · 18x19	
Prijs	€	81,90	



Set van 12 steekringsleutels gaande van 8 tot 19mm.

Kenmerken:

- De ringkant heeft een hellingshoek van 15°.
- Identieke maten aan beide kanten van de sleutel.
- Geleverd met een wandrek voor montage op een muur of wandpaneel.

Order nr.	128240108		
Orig. nr.	WRSP12		
Sleutels	mm	8 · 9 · 10 · 11 · 12 · 13 · 14 · 15 · 16 · 17 · 18 · 19	
Prijs	€	49,50	



12-delige extra lange steekringsleutelset op muurrek.

Kenmerken:

- Zelfde maat op beide uiteinden
- Geleverd met handige rek met markering voor elke sleutel, voor bevestiging aan een perfopaneel of wand

Order nr.	199830100		
Orig. nr.	WRSP12LMP		
Aantal stuks	12		
Maat	mm	8 · 9 · 10 · 11 · 12 · 13 · 14 · 15 · 16 · 17 · 18 · 19	
Prijs	€	57,90	



12-delige ratelsteekringsleutelset op muurrek.

Kenmerken:

- Recht model, draai de sleutel om de richting van de ratel te veranderen
- Zelfde maat op beide uiteinden
- Geleverd met handige rek met markering voor elke sleutel, voor bevestiging aan een perfopaneel of wand

Order nr.	199820101		
Orig. nr.	WRSP12RS		
Aantal stuks	12		
Maat	mm	8 · 9 · 10 · 11 · 12 · 13 · 14 · 15 · 16 · 17 · 18 · 19	
Prijs	€	139,00	



Set van 7 sleutels TX/TPX met T-hendel.

Kenmerken:

- Gaande van TX10 tot TX40.
- Met TPX aan de korte kant van de sleutel.

Geleverd met een wandrek voor montage op een muur of wandpaneel.

Order nr.	128270105		
Orig. nr.	WRTX07		
Sleutels	TX-TPX	10 · 15 · 20 · 25 · 27 · 30 · 40	
Prijs	€	29,90	



Set van 7 allensleutels met T-hendel. MM of AF.

Kenmerken:

- Met bolkop aan de lange kant van de sleutel, voor een 30° draaiing.

Geleverd op een wandrek. Voor montage op een muur of wandpaneel.

Order nr.	128260106	128260205
Orig. nr.	WRHEX07	WRHEX07AF
Aantal stuks	7	7
Sleutels	mm	2,5 · 3 · 4 · 5 · 6 · 7 · 8
Sleutels	inch	3/32 · 1/8 · 5/32 · 3/16 · 7/32 · 1/4 · 5/16
Prijs	€	36,90
		35,50

TENGOOLS



NEW

6 delige schroevendraaierset TX met T-hendel. Geleverd met houder voor wandmontage.

Order nr.	237730106		
Orig. nr.	MDM706TXT		
Schroevendraaiers TX	mm	TX6-TX7-TX8-TX9-TX10-TX15	
Prijs	€	12,60	

TENGOOLS



Set van 10 Mega Drive schroevendraaiers plat, Ph en Pz.

Kenmerken:

- Ergonomisch zwart-rood twee componenten handvat.

Geleverd met een wandrek voor montage op een muur of wandpaneel.

Order nr.	174510107		
Orig. nr.	WRMD10N		
Schroevendraaiers Plat	mm	0,5x3,0x100 - 1,0x5,5x75 - 1,0x5,5x150 - 1,2x6,5x150 - 1,2x8,0x150	
Schroevendraaiers PH		0x75 - 1x75 - 2x100	
Schroevendraaiers PZ		1x75 - 1x100	
Prijs	€	49,50	

TENGOOLS



Schroevendraaierset 7dlg 1000V op muurrek.

Order nr.	174520205		
Orig. nr.	WRMDV07N		
Schroevendraaiers Plat	mm	0.4x2.5x75mm, 0.5x3.0x100mm, 0.8x4.0x100mm, 1.0x5.5x125mm	
Schroevendraaiers PH	mm	PH1x80mm, PH2x100mm	
Voltage tester		100V-250V	
Prijs	€	27,90	

TENGOOLS



Schroevendraaierset 5dlg 1000V op muurrek.

Order nr.	174520106		
Orig. nr.	WRMDV05N		
Maat PH		0x75 - 1x75	
Maat PZ		1x75	
Schroevendraaiers Plat	mm	0,5x3,0x100 - 1,0x5,5x75	
Prijs	€	29,90	

TENGOOLS



Set van 4 Mega Bite tangen met kunstof zwart-rode handgrepen.

Bestaande uit:

- 1 waterpomptang 250mm
- 1 zijknip tang 150mm
- 1 lange bektang 200mm
- 1 combinatie tang 175mm

Geleverd met een wandrek voor montage op een muur of wandpaneel.

Order nr.	128330107		
Orig. nr.	WRMB04		
Prijs	€	61,50	

TENGOOLS



Set van 5 handvijen L. 250mm middelgrof.

Bestaat uit:

- 1 ronde handvijl
- 1 halfronde handvijl
- 1 vierkante handvijl
- 1 driehoek handvijl
- 1 platte handvijl

Geleverd met een wandrek voor montage op een muur of wandpaneel.

Order nr.	128660107		
Orig. nr.	WRFL05		
Prijs	€	34,50	

TENGOOLS



10-delig beitel en doorslagenset.

Bestaat uit:

- Doorslagen 3,4,5,6,7,8, mm
- Koudbeitels 18x150, 25x200, 25x250
- Centerpunt 5 mm
- wandrek

Order nr.	199810102		
Orig. nr.	WRPC10		
Top diameter doorslagen	mm	3 - 4 - 5 - 6 - 7 - 8	
Breedte beitels	mm	18 - 25	
Punt diameter centerdoorslag	mm	5	
Prijs	€	53,90	

TOOLS

DOPPEN

Het assortiment omvat 1/4" tot 1" doppen, 6- en 12-kant, metrisch en AF evenals TX-E. Een brede selectie van dopbitsen voor HEX, TX en TPX wordt verder aangevuld door een reeks adapters voor gebruik met het uitgebreide aanbod aan bitsen. Zie ook het hoofdstuk schroevendraaiers van deze catalogus.

- Alle Teng Tools doppen en accessoires zijn individueel gemerkt en vervaardigd uit hoogwaardig chroom vanadium staal, in overeenstemming met de meest recente DIN en ISO standaarden.
- Teng Tools doppen zijn voorzien van het "hip grip" systeem om de kracht op de kant en niet op de hoek uit te oefenen. Dit voorkomt dat de bouten beschadigd worden, en maakt het gebruik op eerder beschadigde bouten mogelijk.
- Veiligheidsvergrendeling in 3/4" doppen, om te voorkomen dat de doppen van het verlengstuk loskomen.
- Elke dop en accessoire wordt op een PP kaart geleverd, inclusief voor 1/4", 3/8" en 1/2" een speciale clip voor gebruik op de Teng Tools aluminium rails. Daarmee kan de gebruiker zijn eigen rails volgens zijn specifieke eisen samenstellen.





Get organised™



Ratels

TENGOOLS



Set van 3 Teng ratels 72-tands van 1/4", 3/8" en 1/2". TC-tray.

Order nr.	128210101	
Orig. nr.	TT7203	
Aantal stuks	3	
Ratels	inch	1/4 - 3/8 - 1/2
Afmetingen (l x b x h)	mm	265 x 142 x 50
Prijs	€	85,90

TENGOOLS



Mini bitsratel 1/4" L.90mm met aan de andere sleutelzijde een 8mm ringopname.

Kenmerken:

- Chroom-vanadium.
- Verchroomde uitvoering.

Order nr.	118340108	
Orig. nr.	1400B	
Lengte	mm	90
Prijs	€	24,00

TENGOOLS

Ratel 1/4" handpalm-model.



Kenmerken:

- Met links-rechtsomkeerknop in het handvat.

Ideaal voor gebruik in nauwe plaatsjes.

Order nr.	132090101	
Orig. nr.	1400M	
Aansluiting	inch	1/4
Aantal tanden		45
Lengte	mm	76
Prijs	€	17,50

TENGOOLS



Universele Teng ratel model FRP met 45-tands aandrijfmechanisme.

Kenmerken:

- Gepatenteerde (24583ROC) vezelversterkte uitvoering.
- Zeer licht eigengewicht maar sterk.
- Links-rechtsinstelling dmv een hendel.
- Snel-ontkoppelknop (push-through) vergemakkelijkt het loslaten van de dop.

Order nr.	74290107	74290206	74290305
Orig. nr.	1400FRP	3800FRP	1200FRP
Aansluiting	inch	1/4	3/8
Aantal tanden		45	45
Lengte	mm	150	200
Prijs	€	23,50	30,50

TENGOOLS



Universele ratel met 60-tands aandrijfmechanisme.

Kenmerken:

- Chroom-vanadium.
- Verchroomde uitvoering.
- Rubber bekleed handvat.
- Links-rechtsinstelling dmv een hendel.
- Snel-ontkoppelknop (push-through) vergemakkelijkt het loslaten van de dop.

Order nr.	160700100	160700209	160700308
Orig. nr.	1400-60T	3800-60T	1200-60T
Aansluiting	inch	1/4	3/8
Aantal tanden		60	60
Lengte	mm	150	200
Prijs	€	34,50	38,90

TENGOOLS



Universele Teng ratel met 72-tands aandrijfmechanisme.

Kenmerken:

- Chroom-vanadium.
- Matverchroomde uitvoering.
- Twee-componenten kunststof handvat.
- Links-rechtsinstelling dmv een draaiknop.
- Snel-ontkoppelknop (push-through) vergemakkelijkt het loslaten van de dop.

Order nr.	186140109	186140208	186140307
Orig. nr.	1400-72N	3800-72N	1200-72N
Aansluiting	inch	1/4	3/8
Aantal tanden		72	72
Lengte	mm	150	203
Prijs	€	34,50	38,90

TENGOOLS



72 tanden flexibele ratel.

Kenmerken:

- Increment van slechts 5 graden.
- 3/8" met snelle ontkoppeling en omkering systeem.
- 1/4" met omkering systeem.
- Satijn afwerking.
- Twee componenten handvat.

Order nr.	186900106	186900205	186900304
Orig. nr.	1400-72SN	3800-72SN	1200-72SN
Aansluiting	inch	1/4"	3/8"
Aantal tanden		72	72
Lengte	mm	121	178
Prijs	€	31,90	36,90

TENGOOLS



Ratel 1/2" met 45-tands aandrijfmechanisme.

Kenmerken:

- Extra lange uitvoering L.432mm.
- Chroom-Vanadium.
- Matverchromde uitvoering.
- Twee-componenten kunststof handvat.
- Links-rechtsinstelling dmv draaiknop in de kop.
- Snel-ontkoppelknop (push-through) vergemakkelijkt het loslaten van de dop.

Order nr.	143830107
Orig. nr.	1200L
Aansluiting	inch 1/2
Aantal tanden	45
Lengte	mm 432
Prijs	€ 33,90

TENGOOLS



Ratel 1/2" met 60-tands aandrijfmechanisme.

Kenmerken:

- Met onder de hoek verstelbare kop.
- Extra lange uitvoering L.432mm.
- Chroom-vanadium.
- Matverchromde uitvoering.
- Twee-componenten kunststof handvat.
- Links-rechtsinstelling dmv draaiknop in de kop.
- Snel-ontkoppelknop.

Order nr.	118060102
Orig. nr.	1200F
Aansluiting	inch 1/2
Aantal tanden	60
Lengte	mm 432
Prijs	€ 34,90

TENGOOLS



Ratel 3/4".

Kenmerken:

- Industriële uitvoering.
- Met 72-tands aandrijfmechanisme.
- Chroom-Vanadium.
- Matverchromde uitvoering.
- Links-rechtsinstelling dmv draaiknop gemonteerd bovenop de ratelkop.
- Snel-ontkoppelknop (push-through) vergemakkelijkt het loslaten van de dop.

Order nr.	143820108
Orig. nr.	M3400-72
Aansluiting	inch 3/4
Aantal tanden	72
Lengte	mm 505
Prijs	€ 119,00

TENGOOLS



Universele Teng ratel. Model DIN 3122D met ofwel 45-tands (3/4") ofwel 24-tands (1") aandrijfmechanisme.

Kenmerken:

- Chroom-vanadium.
- Verchromde uitvoering.
- Links-rechtsinstelling dmv een hendel.
- Snel-ontkoppelknop (push-through) vergemakkelijkt het loslaten van de dop.

Order nr.	73720500
Orig. nr.	M1100
Aansluiting	inch 1
Lengte	mm 660
Prijs	€ 120,00

TENGOOLS



Ratel 1" met 72-tands aandrijf mechanisme.

Kenmerken:

- Industriële uitvoering.
- Chroom-Vanadium.
- Matverchromde uitvoering.
- Links-rechtsinstelling dmv draaiknop gemonteerd bovenop de ratelkop.
- Snel-ontkoppelknop (push-through) vergemakkelijkt het loslaten van de dop.

Order nr.	143810109
Orig. nr.	M1100-72
Aansluiting	inch 1
Aantal tanden	72
Lengte	mm 800
Prijs	€ 185,00

TENGOOLS



Herstelsets voor ratels.

Order nr.	Orig. nr.	Voor type ratel	Prijs €
117391409	3800-72RK	3800-72	22,00
74291006	1400FRPRK	1400FRP	13,70
74291105	3800FRPRK	3800FRP	16,30
74291204	1200FRPRK	1200FRP	18,90
73722050	1400NRK	1400 + PT1400 (generation 2)	12,10
73722159	3800NRK	3800 + PT3800 (generation 2)	14,20
73722209	1200NRK	1200 + PT1200 (generation 2)	16,80
73721003	1400RK-1	1400 (generation 1)	13,70
73721102	3800RK-1	3800 (generation 1)	15,50
73721201	1200RK-1	1200 (generation 1)	19,40
801200341	TT1400STRK	1400ST	12,10
801200344	TT3800STRK	3800ST	14,20
801200336	TT1200STRK	1200ST	18,10
73721300	3400-3RK	3400-3	35,80
73721409	1100RK	1100	54,50
73722308	M3400-3RK	M3400-3	75,30
73722407	M1100RK	M1100	67,50
143811008	M1100-72RK	M1100-72	93,00
143821007	M3400-72RK	M3400-72	80,00
118060201	1200FRK	1200F	18,10
128201001	1400-72STRK	1400-72ST	18,90
160701207	1200-60TRK	1200-60T	33,20
160701009	1400-60TRK	1400-60T	23,30
160701108	3800-60TRK	3800-60T	26,70
117391151	3800-72RK-1	3800-72	24,10
117391250	1200-72RK-1	1200-72	31,90

T-hendels

TENGOOLS



T-baar. DIN3122A. chroom vanadium. Matverchromde uitvoering. Type S is met safety lock. M110030 met opening voor T-baar.

Order nr.	Orig. nr.	Lengte mm	Aansluiting inch	Prijs €
35870104	M140050	105	1/4	5,70
35870153	M380050	170	3/8	10,80
35870179	M120050	243	1/2	14,50
35870203	M340050	450	3/4	36,70
35870302	M340050S-C	450	3/4	42,80
116840208	M110020	550	1 (baar)	47,90

Wielsleutels

TENGOOLS



Wielsleutel geleverd met slagkop met dubbele maatvoering. Uitschuifbaar voor een betere krachtgeving bij het lossen van wioldoppen. Chroom vanadium staal. Onmisbaar in elke wagen. Je mist deze sleutel wanneer het te laat is...

Order nr.	73170102	186810107
Orig. nr.	1202	1202A
Maten	mm 17, 19	21, 22
Aansluiting	inch 1/2	1/2
Lengte ingetrokken/verlengd	mm 350/550	350/550
Prijs	€ 29,80	26,20

TENGOOLS



U-wielsleutel. chroom vanadium. Matverchromde uitvoering.

Order nr.	112040100	112040209
Orig. nr.	M380011-C	M120011-C
Aansluiting	inch 3/8	1/2
Lengte	mm 380	420
Prijs	€ 17,40	20,70

Flexhendels

TENGOOLS



11-delige set. TC-tray.

Bestaande uit:

- 10 lange doppen 1/2" 12-kant.
- 1 handvat 1/2" met flexibele aansluiting 250mm.

Order nr.	122090103
Orig. nr.	TT1211
Doppen 1/2" lang	mm 10-11-12-13-14-15-16-17-18-19
Afmetingen (l x b x h)	mm 265 x 142 x 50
Prijs	€ 54,50

TENGOOLS



Flex-hendel. chroom vanadium. Matverchromde uitvoering. Twee-componenten kunststof handvat (niet 3/4"). Type S is met safety lock.

Order nr.	Orig. nr.	Lengte mm	Aansluiting inch	Prijs €
73980104	M120010	250	1/2	27,10
73980203	1201	425	1/2	42,20
73980252	1201A	600	1/2	65,00
73980302	M340070	475	3/4	53,40
73980401	M340070S-C	475	3/4	61,70
231370107	M110070	650	1	149,70

TENGOOLS



Reparatiekits voor flexhandels.

Order nr.	73981003	73982001	73981052
Orig. nr.	1201RK	FHP3402	1201ARK
Voor flex hendel	1201	M340070S	1201A
Prijs	€ 14,20	15,00	16,30

TENGOOLS



Chroom vanadium. Gesatineerd. Twee-componenten handvat.

Order nr.	152800108
Orig. nr.	M380010A-C
Lengte	mm 250
Aansluiting	inch 3/8
Prijs	€ 27,60

Verlengstukken

TENGOOLS



Verlengstukken. DIN3123B. chroom vanadium. Matverchromde uitvoering. Type A: klassiek verlengstuk. Type B: type met bolkop (wobble) aan de dop-kant. Type C: flexibel verlengstuk in kunststof. Type D: met safety lock. Type E: Roestvrijstaal.

Order nr.	Orig. nr.	Type	Lengte mm	Aansluiting inch	Prijs €
29960101	M140038-C	C	150	1/4	9,10
06790109	M140020	A	50	1/4	3,20
06790158	M140023	A	75	1/4	3,60
06790208	M140021	A	100	1/4	4,10
06790307	M140022	A	150	1/4	4,40
06790356	M140024	A	300	1/4	9,10
06790406	M380020	A	75	3/8	4,30
162610109	MS380020-C	E	75	3/8	33,10
01101708	M380020W-C	B	75	3/8	8,90
06790455	M380023	A	125	3/8	5,50
162610208	MS380023-C	E	125	3/8	49,70
06790505	M380021	A	150	3/8	6,10
01101807	M380021W	B	150	3/8	9,80
06790604	M380022	A	250	3/8	8,70
01101906	M380022W	B	250	3/8	11,90
06790703	M380024	A	500	3/8	29,80
73860108	M120020	A	60	1/2	5,30
01102003	M120020W	B	75	1/2	11,70
73860207	M120021	A	125	1/2	7,00
73860256	M120023	A	150	1/2	7,90
162590103	MS120021-C	E	125	1/2	76,90
01102102	M120021W	B	150	1/2	13,30
73860306	M120022	A	250	1/2	12,20
01102201	M120022W	B	250	1/2	16,50
73860355	M120024	A	500	1/2	34,50
73860405	M340020	A	100	3/4	18,70
73860454	M340020S-C	D	100	3/4	30,40
73860504	M340021	A	200	3/4	24,90
73860553	M340021S-C	D	200	3/4	35,30
73860603	M340022	A	400	3/4	38,70
73860652	M340022S-C	D	400	3/4	50,60
73860702	M110040	A	200	1	44,20
73860801	M110050	A	400	1	71,90

Adaptors

TENGOOLS



Elleboogstuk. DIN3123C. chroom vanadium. Matverchromde uitvoering.

Order nr.	Orig. nr.	Aansluiting inch	Prijs €
74110057	M140030	1/4	9,20
74110073	M380030	3/8	11,30
74110107	M120030	1/2	17,40
74110206	M340030	3/4	49,20

TENGOOLS



Adaptor.

Adaptor met of zonder opening voor aanschroeven met een staaf. Chroom vanadium. Satijnafwerking.

Order nr.	Orig. nr.	Prijs €
35650050	M140036	3,20
35640101	M380035	4,60
35650100	M380036	6,30
35640200	M120036	5,40
35650209	M120037	7,50
35650407	M110030	32,60
35650308	M340085	23,40
35640309	M340086-C	12,80

TENGOOLS



Dopbitshouder. DIN3126. chroom vanadium. Matverchromde uitvoering.

Order nr.	Orig. nr.	Aansluiting inch	Voor biten	Prijs €
35630102	M140060	1/4	1/4" hex	3,60
35810100	M380060	3/8	1/4" hex	3,90
101670057	M380061	3/8	10mm hex	4,60
35810209	M120060	1/2	5/16" hex	7,30
101670107	M120061	1/2	10mm hex	9,00
101670206	M120062	1/2	12mm hex	7,30

TENGOOLS



Adaptor. Met zeskant aansluiting. Voor montage op boorkop en uitwendige SQUARE-aansluiting voor doppen aan het andere einde.

Order nr.	117110106	117110205
Orig. nr.	M140037	M380037
Hexagonale aansluiting	inch 1/4	1/4
Vierkante aansluiting	inch 1/4	3/8
Prijs	€ 1,10	4,40

TENGOOLS



Adaptor met een opening voor aanschroeven met een staaf. RVS.

Order nr.	167600105	167600204
Orig. nr.	MS380036-C	MS120036-C
Aansluiting	inch 3/8	1/2
Type	3/8F x 1/2M	1/2F x 3/8M
Opening	✓	✓
Prijs	€ 28,40	32,60

TENGOOLS



Adaptors set. 4 stuks.
Bestaat uit: M140036M
(1/4"x3/8"), M380036M
(3/8"x1/2"), M120037M
(1/2"x3/4") en M340085M
(3/4"x1").

Order nr.	231421009
Orig. nr.	MX04
Prijs	€ 59,50

TENGOOLS



Magnetische adaptor.

Order nr.	Orig. nr.	Aansluiting inwendig	Aansluiting uitwendig	Hoogte	Diameter plaat	Prijs
		inch	inch	mm	mm	€
231420100	M140036M	1/4	3/8	15	28	14,50
231420209	M380036M	3/8	1/2	20	30	22,00
231420308	M120037M	1/2	3/4	30	45	25,60
231420407	M340085M	3/4	1	35	54	29,80

Koppelvermeerderaars

TENGOOLS



Set. TTX-tray.

Bestaande uit:

- 1 momentsleutel 1/2" 40-210Nm
- 1 krachtvermeerderaar 1/2"-3/4" 1400Nm.

Order nr.	128220100
Orig. nr.	TTXMP12
Inkomende aansluiting	inch 1/2
Krachtvermeerderaar	Nm 1400
Momentsleutel 1/2"	Nm 40-200 (max. 200x3 met momentsleutel in deze set)
Uitgaande aansluiting	inch 3/4
Prijs	€ 331,00

TENGOOLS



Krachtvermeerderaar. Met ratio 1:3. Precisie-instrument voor het losmaken en vastzetten van bouten en moeren. Te gebruiken met momentsleutel en slagdoppen.

Order nr.	122070105	122070204	174650101
	T	T	T
Orig. nr.	MP1400	MP2700	MP91500
Inkomende aansluiting	inch 1/2	3/4	1/2
Uitgaande aansluiting	inch 3/4	1	3/4
Versterking	1:3	1:3	1:10
Maximum bereik	lbs. 1000	2000	1100
Maximum bereik	ft 1400	2700	1500
Prijs	€ 296,00	341,00	290,00

TENGOOLS



MPSL01

MPSL02

Steun voor krachtvermeerderaar.

Order nr.	122070303	122070402
Orig. nr.	MPSL01	MPSL02
Omschrijving	voor MP1400	voor MP2700
Prijs	€ 52,60	55,30

TENGOOLS



Herstelkit voor
krachtvermeerderaars.

Order nr.	Orig. nr.	Prijs
		€
122070808	MP1400RK	138,00
122070907	MP1400RK-1	138,00
122070956	MP2700RK-1	151,00
122070857	MP2700RK	151,00
174651000	MP91500RK	119,00

Dop -en dopbits schroevendraaiers

TENGOOLS



Dop en dopbits schroevendraaier met vierkant-aandrijving 1/4" of 3/8". chroom vanadium. Matverchroomde uitvoering. Met hard kunststof handvat. Handvat met interne aansluiting voor gebruik met een T-hendel.

Order nr.	34860106	34860205
Orig. nr.	M140015	M380015
Lengte	mm 150	255
Aansluiting	inch 1/4	3/8
Prijs	€ 9,20	16,00

TENGOOLS



Dop en dopbits schroevendraaier met vierkant-aandrijving 3/8". chroom vanadium. Matverchroomde uitvoering. Met 3/8"-F aandrijving in de top van de hendel.

Order nr.	03050101
Orig. nr.	PT3810R
Lengte	mm 250
Aansluiting	inch 3/8
Prijs	€ 27,50

TENGOOLS



NEW

Dopbitsen schroevendraaier met ratel.
Aansluiting 1/4" met magneet om de bits en de schroef vast te houden.
Twee componenten handvat met ophanggat.
Met 6 bitsen en adapters in het handvat opgeslagen.

Order nr.	237710108	
Orig. nr.	MDRT908	
Lengte	mm	172
Bitsen 1/4" plat	mm	5-7
Bitsen 1/4" PH	PH1-PH2	
Bitsen 1/4" PZ	PZ1-PZ2	
Adapter	inch	1/4x1/4
Prijs	€	44,10

Bougiedoppen

TENGOOLS



5-delige set van flex-bougiedoppen 3/8".

Kenmerken:

- Met opening voor T-hendel.
- Met T-baar.
- TTX-tray.

Order nr.	178801007	
Orig. nr.	TTXTB05	
Doppen 3/8"	mm	14 - 16 - 21
Handvat lengte	mm	520
Afmetingen (l x b x h)	mm	560 x 110 x 40
Prijs	€	61,50

TENGOOLS



Bougiedoppen 3/8" en 1/2" 6-kant. Met rubber-inzet. Met uitwendige 24mm zeskant-aansluiting op het uiteinde van de dop voor aanspannen met een sleutel. chroom vanadium. Matverchromde uitvoering.

Order nr.	Orig. nr.	Maat mm	Lengte mm	Aansluiting inch	Type	Prijs €
39820055	M380039-C	14	64	3/8	standaard	6,90
39820105	M380040	16	64	3/8	standaard	4,80
39820121	M380041	16	85	3/8	flexibel	13,20
39820154	M380042	18	70	3/8	standaard	6,40
39820204	M380046	21	70	3/8	standaard	6,50
39820303	M380047	21	91	3/8	flexibel	15,10
69790103	M120040	16	70	1/2	standaard	6,60
69790202	M120042	18	70	1/2	standaard	8,40
69790301	M120046	21	70	1/2	standaard	8,70

Doppen 1/4"

TENGOOLS



Dop 1/4" 6-kant. Korte uitvoering 25mm. DIN 3124-ISO 2725. chroom vanadium. Matverchromde uitvoering.

Order nr.	Orig. nr.	Maat mm	Maat inch	Prijs €
25670100	M140504	4		2,10
25670159	M1405045	4,5		2,10
25670209	M140505	5		2,10
25670258	M1405055	5,5		2,10
25670308	M140506	6		2,10
25670407	M140507	7		2,10
25670506	M140508	8		2,10
25670605	M140509	9		2,10
25670704	M140510	10		2,10
25670803	M140511	11		2,10
25670902	M140512	12		2,20
25671009	M140513	13		3,20
69800100	M140106		3/16	2,00
69800209	M140107		7/32	2,00
69800308	M140108		1/4	2,00
69800407	M140109		9/32	2,00
69800506	M140110		5/16	2,00
69800605	M140111		11/32	2,00
69800704	M140112		3/8	2,10
69800803	M140114		7/16	2,30
69800902	M140116		1/2	2,30

TENGOOLS



Dop 1/4" 6-kant. Lange uitvoering. L. 49,5mm. DIN 3124-ISO 2725. chroom vanadium. Matverchromde uitvoering.

Order nr.	Orig. nr.	Maat mm	Maat inch	Prijs €
35620038	M140604	4		4,40
35620061	M140605	5		4,40
35620095	M1406055	5,5		4,40
35620103	M140606	6		4,40
35620202	M140607	7		4,60
35620301	M140608	8		4,60
35620350	M140609	9		4,40
35620400	M140610	10		4,60
35620459	M140611	11		4,60
35620509	M140612	12		4,60
35620608	M140613	13		5,00
69890101	M140206		3/16	4,20
69890150	M140207		7/32	4,20
69890208	M140208		1/4	4,20
69890259	M140209		9/32	4,20
69890309	M140210		5/16	4,20
69890358	M140211		11/32	4,20
69890408	M140212		3/8	4,30
69890507	M140214		7/16	4,30
69890606	M140216		1/2	4,40

TOOLS

TENGIOLS



Afzonderlijke carterplug-doppen met verschillende types en maten geschikt voor carterpluggen in de motor en versnellingsbak.

Order nr.	Orig. nr.	Maat	Prijs €
62571005	DP0810	hex 8mm x 10mm hex	5,20
62571104	DP0812	vierkant 8mm x 3/8" vierkant	5,20
62571203	DP1012	hex 5/16" x 3/8" hex	5,20
62571302	DP1112	vierkant 11mm x 12mm hex	5,20
62571401	DP1314	vierkant 13mm x 14mm hex	5,20
62571500	DP1716	hex 17mm x 1/2" hex	5,20

TENGIOLS



Dop 1/4" TX-E. Korte uitvoering. Chroom Vanadium. Matverchroomde uitvoering.

Order nr.	Orig. nr.	Maat TX-E	Lengte mm	Prijs €
101850105	M140704	E4	23,1	3,30
101850204	M140705	E5	24,8	3,30
101850303	M140706	E6	24,8	3,30
101850402	M140707	E7	24,8	3,30
101850501	M140708	E8	24,8	3,30

TENGIOLS



Dopbits 1/4" met Plat-bits. chroom vanadium. Matverchroomde uitvoering.

Order nr.	Orig. nr.	Lengte mm	Maat plat	Prijs €
68280205	M1414055	32	1,2x5,5	2,80
68280304	M141407	32	1,4x7	2,80
68280106	M141404	32	0,76x4	2,80

TENGIOLS



Dopbits 1/4" met Philips-bits. chroom vanadium. Matverchroomde uitvoering.

Order nr.	Orig. nr.	Lengte mm	Maat PH	Prijs €
68260058	M141300	32	0	2,80
68260108	M141301	32	1	2,80
68260207	M141302	32	2	2,80
68260306	M141303	32	3	2,80

TENGIOLS



Dopbits 1/4" met Pozidriv-bits. chroom vanadium. Matverchroomde uitvoering.

Order nr.	Orig. nr.	Lengte mm	Maat PZ	Prijs €
68350107	M141601	32	1	2,80
68350206	M141602	32	2	2,80
68350305	M141603	32	3	2,80

TENGIOLS



Dopbits 1/4" met TX-bits. chroom vanadium. Matverchroomde uitvoering.

Order nr.	Orig. nr.	Lengte mm	Maat TX	Prijs €
112060108	M141210T-C	32	10	3,20
112060207	M141215T-C	32	15	3,20
112060306	M141220T-C	32	20	3,20
112060405	M141225T-C	32	25	3,20
112060504	M141227T-C	32	27	3,20
112060603	M141230T-C	32	30	3,20
112060702	M141240T-C	32	40	3,50

TENGIOLS



Tapdop 1/4" om draad te snijden. Te gebruiken met een mini palm ratel.

Order nr.	167490200	167490309
Orig. nr.	M140071	M140072
Voor tappen	M	3-8
Diameter koppel	mm	20
Prijs	€ 16,00	19,30

Doppen 3/8"

TENGOOLS



Dop 3/8" 6-kant. Korte uitvoering. DIN 3124-ISO 2725. chroom vanadium. Matverchroomde uitvoering.

Order nr.	Orig. nr.	Maat mm	Lengte mm	Maat inch	Prijs €
26210054	M380507	7	25,7		2,60
26210104	M380508	8	25,7		2,50
26210203	M380509	9	25,7		2,90
26210302	M380510	10	25,7		2,90
26210401	M380511	11	25,7		2,90
26210500	M380512	12	25,7		2,90
26210609	M380513	13	25,7		2,90
26210708	M380514	14	25,7		3,10
26210807	M380515	15	25,7		3,10
26210906	M380516	16	29		2,90
26211003	M380517	17	29		3,70
26211102	M380518	18	29		3,90
26211201	M380519	19	29		4,10
26211300	M380520	20	29		4,30
26211409	M380521	21	29		4,40
26211508	M380522	22	29		4,60
69950103	M380110		25,7	5/16	2,90
69950202	M380112		25,7	3/8	2,90
69950301	M380114		25,7	7/16	2,90
69950400	M380116		25,7	1/2	2,90
69950509	M380118		25,7	9/16	2,90
69950608	M380120		29	5/8	2,90
69950707	M380122		29	1 1/16	3,70
69950806	M380124		29	3/4	4,10
69950905	M380126		29	13/16	4,40
69951002	M380128		29	7/8	4,60

TENGOOLS



Dop 3/8" 6-kant. Lange uitvoering. DIN 3124-ISO 2725. chroom vanadium. Matverchroomde uitvoering.

Order nr.	Orig. nr.	Maat mm	Lengte mm	Maat inch	Prijs €
35860055	M380607	7	45,5		4,30
35860105	M380608	8	45,5		4,30
35860154	M380609	9	45,5		4,30
35860204	M380610	10	45,5		4,40
35860253	M380611	11	45,5		4,30
35860303	M380612	12	45,5		4,40
35860402	M380613	13	45,5		4,60
35860451	M380614	14	50		4,70
35860477	M380615	15	53		4,70
35860493	M380616	16	53		5,40
35860501	M380617	17	56		5,80
35860550	M380618	18	56		5,90
35860600	M380619	19	56		6,50
35860709	M380620	20	63,5		6,90
35860808	M380621	21	63,5		6,90
35860907	M380622	22	63,5		7,40
69970101	M380212		45,5	3/8	4,20
69970200	M380214		45,5	7/16	4,20
69970309	M380216		45,5	1/2	4,30
69970408	M380218		50	9/16	4,60
69970507	M380220		53	5/8	4,70
69970606	M380222		56	1 1/16	6,10
69970705	M380224		56	3/4	6,60
69970804	M380226		63,5	13/16	6,60
69970903	M380228		63,5	7/8	7,50

TENGOOLS



Dop 3/8" TX-E. Korte uitvoering. chroom vanadium. Matverchroomde uitvoering.

Order nr.	Orig. nr.	Lengte mm	Maat TX-E	Prijs €
101690105	M380710	28	E 10	5,00
101690204	M380712	28	E 12	5,00
101690303	M380714	28	E 14	5,00
101690402	M380716	28	E 16	5,00
101690501	M380718	28	E 18	5,00

TOOLS

Doppen & accessoires

TENGOOLS



Dopbits 3/8" met Hex-bits. Korte uitvoering. Chroom vanadium. Matverchromde uitvoering. L. 49,5mm.



Order nr.	Orig. nr.	Maat mm	Maat inch	Prijs €
102070109	M381503	3		4,40
102070208	M381504	4		4,40
102070307	M381505	5		4,40
102070406	M3815055	5,5		4,40
102070505	M381506	6		4,40
102070604	M381507	7		4,40
102070703	M381508	8		4,40
102070802	M381510	10		4,60
102070901	M381512	12		8,10
114820103	M381103		3/32	4,40
114820202	M381104		1/8	4,40
114820301	M381105		5/32	4,40
114820400	M381106		3/16	4,40
114820509	M381107		7/32	4,40
114820608	M381108		1/4	4,40
114820707	M381110		5/16	4,40
114820806	M381112		3/8	4,60

TOOLS

TENGOOLS



Dopbits 3/8" met TX-bits. Korte uitvoering. chroom vanadium. Matverchromde uitvoering. L. 49,5mm.



Order nr.	Orig. nr.	Maat TX	Prijs €
102080108	M381210T	10	4,60
102080207	M381215T	15	4,60
102080306	M381220T	20	4,60
102080405	M381225T	25	4,60
102080504	M381227T	27	4,60
102080603	M381230T	30	4,60
102080702	M381240T	40	4,60
102080801	M381245T	45	4,60
102080900	M381250T	50	4,60

TENGOOLS



Dopbits 3/8" met TPX-bits. Korte uitvoering. chroom vanadium. Matverchromde uitvoering. L. 49,5mm.



Order nr.	Orig. nr.	Maat TPX	Prijs €
102090107	M381210	10	4,60
102090206	M381215	15	4,60
102090305	M381220	20	4,60
102090404	M381225	25	4,60
102090503	M381227	27	4,60
102090602	M381230	30	4,60
102090701	M381240	40	4,60
102090800	M381245	45	4,60
102090909	M381250	50	4,60

TENGOOLS



10-delige extra lange doppen set 3/8" met T-schacht en kunststof hendel. Geleverd in een handige roltas.

Order nr.	178791000			
Orig. nr.	TBW10			
Doppen 3/8"	mm	7 - 8 - 10 - 12 - 13 - 14 - 17 - 19		
Lengte 2-delige T-hendel	mm	300		
Prijs	€	95,50		

TENGOOLS

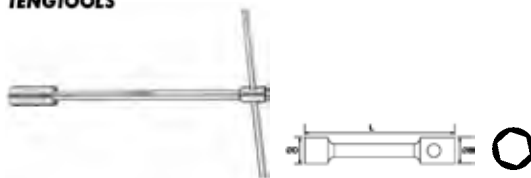

T-bar met lange dop. Aansluiting 3/8".

Order nr.	Orig. nr.	Maat mm	L mm	B mm	D mm	Prijs €
178790051	TBSKT07	7	300	19	10,8	13,90
178790101	TBSKT08	8	300	19	12	13,90
178790309	TBSKT10	10	300	19	14,7	13,90
178790507	TBSKT12	12	300	19	17,1	14,50
178790606	TBSKT13	13	300	19	18,5	14,90
178790705	TBSKT14	14	300	19	19,5	14,90
178790804	TBSKT17	17	300	19	23,3	16,90
178790903	TBSKT19	19	300	19	25,7	16,90

Doppen 1/2"

TENGOOLS



Dopbitsen HEX 1/2" AF. Chroom vanadium staal. Satijnafwerking.

Order nr.	Orig. nr.	Maat inch	L1 mm	L2 mm	Diameter mm	Prijs €
237690102	M121106-C	3/16	55	20	22	4,80
237690201	M121107-C	7/32	55	20	22	4,80
237690300	M121108-C	1/4	55	20	22	4,80
237690409	M121109-C	9/32	55	20	22	4,80
237690508	M121110-C	5/16	55	20	22	4,80
237690607	M121112-C	3/8	55	20	22	5,20
237690706	M121116-C	1/2	55	20	22	5,90
237690805	M121118-C	9/16	55	20	22	7,50
237690904	M121120-C	5/8	55	20	22	8,70

TENGOOLS



Dop 1/2" 12-kant. Korte uitvoering. DIN 3124-ISO 2725. chroom vanadium. Matverchromde uitvoering.

Order nr.	Orig. nr.	Maat mm	Lengte mm	Maat inch	Prijs €
74310038	M120508	8	38		3,70
74310061	M120509	9	38		3,70
74310103	M120510	10	38		3,70
74310202	M120511	11	38		3,70
74310301	M120512	12	38		3,70
74310400	M120513	13	38		3,70
74310509	M120514	14	38		3,70
74310608	M120515	15	38		3,70
74310707	M120516	16	38		3,90
74310806	M120517	17	38		4,30
74310905	M120518	18	38		4,60
74311002	M120519	19	38		5,20
74311101	M120520	20	38		5,40
74311200	M120521	21	38		5,40
74311309	M120522	22	40		5,80
74311408	M120523	23	40		5,80
74311507	M120524	24	40		6,30
74311556	M120525	25	40		6,40
74311655	M120526	26	40		6,80
74311804	M120527	27	43		7,40
74311754	M120528	28	43		7,50
74311853	M120529	29	43		7,60
74312109	M120530	30	43		8,10
74312208	M120532	32	43		8,50
74312257	M120534	34	45,5		12,70
74315508	M120112		38	3/8	3,70
74315607	M120114		38	7/16	3,70
74315706	M120116		38	1/2	3,70
74315805	M120118		38	9/16	3,70
74316001	M120120		38	5/8	3,70
74316100	M120122		38	11/16	3,70
74316209	M120124		38	3/4	4,80
74316407	M120126		38	13/16	5,30
74316506	M120128		40	7/8	5,70
74316605	M120130		40	15/16	6,10
74316704	M120132		43	1	6,80
74316803	M120134		43	1 1/16	7,40
74316902	M120136		43	1 1/8	7,50
74317009	M120138		43	1 3/16	7,90
74317108	M120140		43	1 1/4	8,40

TENGOOLS



Dop 1/2" 6-kant. Korte uitvoering. mm-uitvoering. DIN 3124-ISO 2725. chroom vanadium. Matverchromde uitvoering.

Order nr.	Orig. nr.	Maat mm	Lengte mm	Prijs €
74313008	M1205106	10	38	3,70
74313107	M1205116	11	38	3,70
74313206	M1205126	12	38	3,70
74313305	M1205136	13	38	3,70
74313404	M1205146	14	38	3,70
74313503	M1205156	15	38	3,70
74313602	M1205166	16	38	3,90
74313701	M1205176	17	38	4,30
74313800	M1205186	18	38	4,60
74313909	M1205196	19	38	5,20
74314006	M1205206	20	38	5,40
74314105	M1205216	21	38	5,50
74314204	M1205226	22	40	5,80
74314303	M1205236	23	40	5,80
74314402	M1205246	24	40	6,30
74314501	M1205256	25	40	6,40
74314600	M1205266	26	40	6,80
74314709	M1205276	27	43	7,50
74314808	M1205286	28	43	7,50
74314907	M1205296	29	43	7,60
74315003	M1205306	30	43	8,10
74315102	M1205326	32	43	8,50
74312307	M1205336	33	45,5	10,80
74315201	M1205346	34	45,5	12,20

TENGOOLS



Dop 1/2" 12-kant. Lange uitvoering. 79 mm-uitvoering. DIN 3124-ISO 2725. chroom vanadium. Matverchromde uitvoering.

Order nr.	Orig. nr.	Maat mm	Prijs €
25730102	M120610	10	8,40
25730201	M120611	11	8,40
25730300	M120612	12	8,40
25730409	M120613	13	8,50
25730508	M120614	14	8,70
25730607	M120615	15	8,90
25730706	M120616	16	8,60
25730805	M120617	17	8,90
25730904	M120618	18	8,70
25731001	M120619	19	8,90
25731100	M120620	20	8,70
25731209	M120621	21	8,90
25731308	M120622	22	9,10
25731407	M120624	24	9,70
25731506	M120627	27	14,50
25731605	M120630	30	16,50
25731704	M120632	32	17,90
25731803	M120636	36	20,70

TOOLS

TENGTOLS



Dop 1/2" 6-kant. Lange uitvoering. 79mm-uitvoering. DIN 3124-ISO 2725. chroom vanadium. Matverchromde uitvoering.



Order nr.	Orig. nr.	Maat mm	Prijs €
25732009	M1206136	13	8,40
25732108	M1206146	14	8,60
25732207	M1206156	15	8,60
25732306	M1206166	16	8,60
25732405	M1206176	17	8,90
25732504	M1206186	18	8,70
25732603	M1206196	19	8,90
25732702	M1206246	24	9,70

TENGTOLS



Dopbits 1/2" met Hex-bits. Korte uitvoering. mm-uitvoering. chroom vanadium. Matverchromde uitvoering. L. 55mm.



Order nr.	Orig. nr.	Maat mm	Prijs €
68200104	M121505	5	5,20
68200203	M121506	6	5,20
68200302	M121507	7	5,20
68200401	M121508	8	5,20
68200500	M121509	9	5,00
68200609	M121510	10	5,70
68200708	M121512	12	6,60
68200807	M121514	14	7,90
68200906	M121517	17	9,60
68201003	M121519-C	19	9,70

TENGTOLS



Dopbits 1/2" met Spline-bits. Lange uitvoering. Chroom vanadium. Matverchromde uitvoering. L. 100mm. (voor X2N schroeven).



Order nr.	Orig. nr.	Maat Spline	Prijs €
144000106	M122805	5	7,30
144000205	M122806	6	7,30
144000304	M122808	8	7,40
144000403	M122810	10	9,50
144000502	M122812	12	11,10
144000601	M122814	14	12,70
144000700	M122816	16	16,00

TENGTOLS



Dopbits 1/2" met TPX-bits. Korte uitvoering. chroom vanadium. Matverchromde uitvoering. L. 55mm.



Order nr.	Orig. nr.	Maat TPX	Prijs €
68250109	M121220	20	5,40
68250208	M121225	25	5,40
68250307	M121227	27	5,40
68250406	M121230	30	5,40
68250505	M121240	40	5,40
68250604	M121245	45	5,70
68250703	M121250	50	5,70
68250802	M121255	55	6,40
68250901	M121260	60	7,00

TENGTOLS



Dopbits 1/2" met TX-bits. Korte uitvoering. chroom vanadium. Matverchromde uitvoering. L. 55mm.



Order nr.	Orig. nr.	Maat TX	Prijs €
117400101	M121220T	20	5,40
117400200	M121225T	25	5,40
117400309	M121227T	27	5,40
117400408	M121230T	30	5,50
117400507	M121240T	40	5,50
117400606	M121245T	45	5,80
117400705	M121250T	50	5,80
117400804	M121255T	55	6,50
117400903	M121260T	60	7,00

TENGTOLS



Dopbits 1/2" met TX-bits. Lange uitvoering. MM uitvoering. chroom vanadium. Matverchromde uitvoering. L. 100mm.



Order nr.	Orig. nr.	Maat TX	Prijs €
117440107	M122220T	20	7,80
117440206	M122225T	25	7,80
117440305	M122227T	27	7,80
117440404	M122230T	30	7,80
117440503	M122240T	40	8,00
117440602	M122245T	45	8,50
117440701	M122250T	50	8,60
117440800	M122255T	55	9,80
117440909	M122260T	60	10,60
117441006	M122270T	70	10,60

TENGOOLS



Dopbits 1/2" met Ribe-bits. Lange uitvoering. chroom vanadium. Matverchroomde uitvoering. L. 100mm.



Order nr.	Orig. nr.	Maat Ribe	Prijs €
143990109	M122704	4	6,90
143990208	M122705	5	6,90
143990307	M122706	6	6,90
143990406	M122708	8	6,90
143990505	M122710	10	9,00
143990604	M122711	11	10,80
143990703	M122712	12	11,80
143990802	M122713	13	12,90

TENGOOLS



Dopbits 1/2" met Hex-bits. Lange uitvoering. mm-uitvoering. chroom vanadium. Matverchroomde uitvoering.



Order nr.	Orig. nr.	Maat mm	Prijs €
117450106	M122505	5	7,60
117450205	M122506	6	7,60
117450304	M122507	7	7,50
117450403	M122508	8	7,50
117450502	M122510	10	8,10
117450601	M122512	12	9,80

TENGOOLS



Dop 1/2" TX-E. Korte uitvoering. chroom vanadium. Matverchroomde uitvoering. L. 38mm.



Order nr.	Orig. nr.	Maat TX-E	Prijs €
112070107	M120710	10	4,80
112070206	M120711	11	5,00
112070305	M120712	12	4,80
112070404	M120714	14	4,80
112070503	M120716	16	4,80
112070602	M120718	18	6,60
112070701	M120720	20	6,60
112070800	M120722	22	6,60
112070909	M120724	24	6,60

TENGOOLS

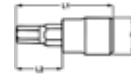

Dopbits 1/2" met Hex-bits. Extra lange uitvoering. mm-uitvoering. chroom vanadium. Matverchroomde uitvoering.

Order nr.	Orig. nr.	Maat mm	L1 mm	L2 mm	Diameter mm	Prijs €
186730107	M122506A	6	115	80	22	7,80
186730206	M122508A	8	115	80	22	7,80
186730305	M122510A	10	175	140	22	9,00

Doppen 3/4"

TENGOOLS



Dop 3/4" 6-kant. Korte uitvoering. mm-uitvoering. DIN 3124-ISO 2725. chroom vanadium. Matverchroomde uitvoering.

Order nr.	Orig. nr.	Maat mm	Lengte mm	Type	Prijs €
36200103	M3405196	19	50	6-kant	11,90
36200202	M3405216	21	50	6-kant	11,90
36200301	M3405226	22	50	6-kant	11,90
36200400	M3405246	24	51	6-kant	12,70
36200509	M3405276	27	52	6-kant	13,80
36200608	M3405306	30	54	6-kant	14,50
36200707	M3405326	32	56	6-kant	14,50
36200806	M3405336	33	56	6-kant	14,50
36200905	M3405346	34	56	6-kant	16,50
36201002	M3405366	36	58	6-kant	17,40
36201101	M3405386	38	60	6-kant	17,90
36201200	M3405416	41	64	6-kant	20,70
36201309	M3405466	46	68	6-kant	23,40
36201408	M3405506	50	72	6-kant	27,60

TENGOOLS



Dop 3/4" 12-kant. Korte uitvoering. AF-uitvoering. DIN 3124-ISO 2725. chroom vanadium. Matverchroomde uitvoering.

Order nr.	Orig. nr.	Lengte mm	Maat inch	Type	Prijs €
114930100	M340124	50	3/4	12-kant	11,90
114930209	M340128	51	7/8	12-kant	11,90
114930308	M340130	51	15/16	12-kant	11,90
114930407	M340132	51	1	12-kant	11,90
114930506	M340134	51	1 1/16	12-kant	12,10
114930605	M340136	51	1 1/8	12-kant	12,90
114930704	M340138	53	1 3/16	12-kant	13,20
114930803	M340140	55	1 1/4	12-kant	13,80
114930902	M340142	55	1 5/16	12-kant	14,50
114931009	M340144	57	1 3/8	12-kant	15,10
114931108	M340146	57	1 7/16	12-kant	16,00
114931207	M340148	57	1 1/2	12-kant	16,50
114931306	M340152	63	1 5/8	12-kant	18,70
114931405	M340156	65	1 3/4	12-kant	20,70
114931504	M340158	67	1 13/16	12-kant	21,50
114931603	M340160	69	1 7/8	12-kant	22,90
114931702	M340164	71	2	12-kant	23,40

TENGOOLS



Dopbitsen 3/4" voor interne hex gaten. Voor manueel aandraaien. Satijn afwerking.

Order nr.	Orig. nr.	Aansluiting inch	Lengte mm	L mm	T mm	D1 mm
231380205	M341514-C	3/4	14	78,5	25	36
231380304	M341517-C	3/4	17	78,5	25	36
231380106	M341519-C	3/4	19	78,5	27	36
231380403	M341522-C	3/4	22	78,5	27	36

Doppen 1"

TENGOOLS



Dop 1" 12-kant. Korte uitvoering. DIN 3124-ISO 2725. chroom vanadium. Matverchromde uitvoering.

Order nr.	Orig. nr.	Maat	Lengte mm	Prijs €
114840101	M110536	36mm	65	23,40
114840200	M110541	41mm	70	26,20
114840309	M110546	46mm	74,5	31,20
114840408	M110550	50mm	75,3	36,70
114840507	M110555	55mm	80	45,10
114840606	M110558	58mm	80	46,40
114840705	M110560	60mm	84	50,60
114840804	M110565	65mm	87,3	61,70
114840903	M110570	70mm	93,4	69,20
114841000	M110575	75mm	96	82,50
114841109	M110580	80mm	103,6	92,20

Slagdoppen

TENGOOLS



Set van 3 lange slagdoppen 1/2" 6-kant metrisch. Chroom molybdeen kwaliteit. Voorzien van een kunststof beschermingshuls over de slagdoppen voor het gebruik bij o.a. alu-velgen.

Order nr.	118870104		
Orig. nr.	9203N		
Lengte	mm	85	
Maten	mm	17, 19, 21	
Prijs	€	48,00	

TENGOOLS



Losse Slagdoppen uit 9203N.

Order nr.	118350107	118350206	118350305
Orig. nr.	920517N	920519N	920521N
Maat	mm 17	19	21
Lengte	mm 85	85	85
Prijs	€ 14,30	14,30	14,80

TENGOOLS



Slagdoppenset voor wielmoeren. Bestaat uit twee omkeerbare 1/2" doppen met verschillende maten aan beide uiteinden en een verlengstuk met opname 1/2".

Order nr.	186370102		
Orig. nr.	9203N1		
Maten doppen	mm	17x19 - 21x22	
Lengte verlengstuk	mm	75	
Prijs	€	25,10	

TENGOOLS



Slagdoppenset 6-kant bestaande uit 8 of 10 korte slagdoppen. Geleverd op een metalen rail met dopclips.

Order nr.	75240101	75240200
Orig. nr.	9381	9121
Doppen 1/2"	mm	10 - 11 - 12 - 13 - 14 - 17 - 19 - 21 - 22 - 24
Aantal stuks	8	10
Doppen 3/8"	mm	8 - 10 - 11 - 13 - 14 - 16 - 17 - 19
Prijs	€ 15,50	34,30

TENGOOLS



Set bestaande uit 8 of 10 lange slagdoppen 6-kant. Geleverd op een metalen rail met dopclips.

Order nr.	114960107	114960206
Orig. nr.	9386	9126
Doppen 1/2"	mm	10 - 11 - 12 - 13 - 14 - 17 - 19 - 21 - 22 - 24
Aantal stuks	8	10
Doppen 3/8"	mm	8 - 10 - 11 - 13 - 14 - 16 - 17 - 19
Prijs	€ 23,50	52,60

TENGOOLS



24-delige slagdoppenset gaande van 6 tot 19mm. TC-tray.

Bestaat uit:

- 5 korte slagdoppen 1/4"
- 9 korte slagdoppen 3/8"
- 9 lange slagdoppen 3/8"
- 1 adaptor 3/8"-1/4"

Order nr.	132470105		
Orig. nr.	TT9024		
Doppen 3/8"	mm	8 - 10 - 11 - 12 - 13 - 14 - 15 - 16 - 17 - 19	
Doppen 1/4"	mm	6 - 7 - 8 - 10 - 13	
Doppen 3/8" lang	mm	8 - 10 - 11 - 12 - 13 - 14 - 15 - 16 - 17 - 19	
Adaptor	inch	3/8 - 1/4	
Prijs	€	58,90	

TENGOOLS



16-delige korte en lange doppenset 1/2" ANSI gaande van 13 tot 24mm. TC-Tray.

Order nr.	68800101		
Orig. nr.	TT9116		
Doppen 1/2"	mm	13 - 15 - 16 - 17 - 18 - 19 - 22 - 24	
Doppen 1/2" lang	mm	13 - 15 - 16 - 17 - 18 - 19 - 22 - 24	
Prijs	€	58,50	

TENGOOLS



Set van 16 slagdoppen. TC-tray.

Bestaat uit:

- 16 korte en lange slagdoppen 1/2" gaande van 13 tot 24mm
- 2 vasthoudpinnen
- 2 O-ringen

Conform DIN-standaard.

Order nr.	143840106		
Orig. nr.	TT9120D		
Doppen 1/2" 6-kant	mm	13 - 15 - 16 - 17 - 18 - 19 - 22 - 24	
Doppen 1/2" 6-kant lang	mm	13 - 15 - 16 - 17 - 18 - 19 - 22 - 24	
Vasthoudpinnen	mm	20X3,5 - 25X3,5	
O-ringen	mm	3x20 - 3x24	
Prijs	€	79,50	

TENGOOLS



7-delige set slagdopaccessoires 1/2". TC-tray.

Bestaande uit:

- 3 verlengstukken
- universele elleboog 1/2"
- 3 adaptors

Order nr.	132460106		
Orig. nr.	TT9207		
Verlengstukken	mm	75 - 125 - 250	
Universele koppeling	inch	1/2	
Adaptors	inch	1/2-3/4 - 3/8-1/2 - 1/2-3/8	
Prijs	€	52,90	

TENGOOLS



Set van 12 slagdopbitsen 1/2" gaande van TX10 tot TX70. TC-tray.

Order nr.	128130101		
Orig. nr.	TT9212TX		
Slagbitsen	TX	10 - 15 - 20 - 25 - 27 - 30 - 40 - 45 - 50 - 55 - 60 - 70	
Prijs	€	92,90	

TENGOOLS



Set van 15 hex slagdoppen 3/8" en 1/2" gaande van 4 tot 19mm. TC-tray.

Order nr.	151410107		
Orig. nr.	TT9015HX		
Dopbitsen 1/2" Hex	mm	5 - 6 - 8 - 10 - 12 - 14 - 17 - 19	
Dopbitsen 3/8" hex	mm	4 - 5 - 6 - 7 - 8 - 10 - 12	
Afmetingen (l x b x h)	mm	265 x 142 x 50	
Prijs	€	100,00	

TENGOOLS



16-delige slagdoppenset. TC-tray.

Bestaat uit:

- 9 korte slagdoppen gaande van 19 tot 38mm
- 1 verlengstuk

Order nr.	160690103		
Orig. nr.	TTD9416		
Doppen 3/4" 6-kant	mm	19 - 24 - 27 - 30 - 32 - 33 - 34 - 36 - 38	
Verlengstuk	mm	175	
Vasthoudpinnen	mm	4x37 (x2)	
O-ringen	mm	38x3,5 (x3)	
Afmetingen (l x b x h)	mm	260 x 280 x 80	
Prijs	€	110,00	

TENGOOLS



Set van 15 korte en lange slagdoppen 3/4" gaande van 19 tot 36mm. TTX-tray.

Order nr.	122080104		
Orig. nr.	TTX9415		
Slagdoppen 3/4"	mm	19 - 24 - 27 - 28 - 30 - 32 - 34 - 36	
Slagdoppen 3/4" lang	mm	19 - 24 - 27 - 30 - 32 - 33 - 36	
Prijs	€	170,00	

TENGI TOOLS



20-delige set. TC-tray.

Bestaande uit:

- 1 slagschroevendraaier 1/2"
- bitshouder 1/2"-5/16"
- adaptor 3/8" M-5/16" Hex
- 17 slagbitsen L.36mm

Order nr.	102100104		
Orig. nr.	TTID20		
Slagbitsen Plat	mm	6 - 8 - 10 - 12	
Slagbitsen PH		1 - 2 - 3 - 4	
Adaptor	inch	3/8-5/16	
Slagbitsen Hex	mm	4 - 5 - 6 - 8	
Slagbitsen TX		30 - 40 - 45 - 50 - 55	
Prijs	€	27,50	

TENGI TOOLS



6-delige slagschroevendraaiersset. Bestaat uit 1 industriële slagschroevendraaier 1/2", 1 slagbitshouder van 1/2" naar 5/16" en 4 slagbitsen 5/16" plat en Ph. Deze slagschroevendraaier kan werken in de twee richtingen. Geleverd in een PVC doosje.

Order nr.	03120102		
Orig. nr.	ID506		
Slagbitsen Plat	mm	1,4x8 - 2,2x10	
Slagbitsen PH		2 - 3	
Prijs	€	35,00	

TENGI TOOLS



Set aparte slagbitsen voor 03120102.

Order nr.	03120201		
Orig. nr.	ID506BIT		
Prijs	€	2,90	

TENGI TOOLS



15-delige slagschroevendraaiersset. Bestaande uit 1 professionele slagschroevendraaier 1/2", 1 slagbitshouder van 1/2" naar 5/16" en 12 slagbitsen 5/16". Deze slagschroevendraaier kan werken in de twee richtingen. Geleverd in een kunststof doosje.

Order nr.	72660103		
Orig. nr.	ID515		
Slagbitsen Plat	mm	1,4x6 - 1,4x8 - 2,2x10	
Slagbitsen PH		1 - 2 - 3 - 4	
Slagbitsen Hex		4 - 5 - 6 - 8	
Prijs	€	29,70	

TENGI TOOLS



Set aparte slagbitsen voor 72660103.

Order nr.	72660202		
Orig. nr.	ID515BIT		
Prijs	€	6,10	

TENGI TOOLS



Slagbitsen 5/16" aandrijfkant. L.36mm.

Order nr.	Orig. nr.	Maat Hex mm	Maat PH	Maat PZ	Maat TX	Maat plat mm	Prijs €
116480104	910504	4					1,30
116480203	910505	5					1,30
116480302	910506	6					1,30
116480401	910508	8					1,30
186720109	910510	10					1,50
116480500	940006					6	1,40
116480609	940008					8	1,40
116480708	940010					10	1,10
116480807	940012					12	1,30
116480906	930001		1				1,40
116481003	930002		2				1,10
116481102	930003		3				1,10
116481201	930004		4				1,10
132230103	920001			1			1,10
132230202	920002			2			1,10
132230301	920003			3			1,10
149870107	970030				30		1,30
149870206	970040				40		1,30
149870305	970045				45		1,30
149870404	970050				50		1,30
149870503	970055				55		1,40

TENGOOLS



Slagbitshouders.

Order nr.	116690207	102100203	116691007
Orig. nr.	980060	980086	920060
Aansluiting	inch 3/8	3/8	1/2
Voor bitsen	inch 1/4	5/16	5/16
Prijs	€ 5,20	1,40	5,30

TENGOOLS



Slagdopadaptors en Verloopstukken. Zonder kogel.

Order nr.	Orig. nr.	O-ringen	Pin nummer	Om-schrijving	Aansluiting inwendig	Prijs
	Nr.				inch	€
116690850	980035	O92419	P902518	verkleiner 3/8 - 1/4	3/8	7,30
116690108	980036-C	O92419	P902518	vergroter 3/8 - 1/2	3/8	8,00
116690801	920036	O935202	P90320	verkleiner 1/2 - 3/8	1/2	8,10
116690900	920037	O935202	P90320	vergroter 1/2 - 3/4	1/2	12,50
116691304	940037	O93538	P90437	verkleiner 3/4 - 1/2	3/4	21,20
116691403	940085	O93538	P90437	vergroter 3/4 - 1	3/4	20,10
116691502	910086	O93546	P90543	verkleiner 1 - 3/4	1	28,50

TENGOOLS



Universele elleboogstukken voor slagdoppen. Zonder kogel.

Order nr.	116690702	116691205
Orig. nr.	920030	940030
O-ringen	Nr. O93528	O93538
Pin nummer	P90328	P90437
Aansluiting inwendig	inch 1/2	3/4
Prijs	€ 21,70	61,80

TENGOOLS



Verlengstukken voor slagdoppen. Met kogel.

Order nr.	Orig. nr.	O-ringen	Aansluiting	Pin	Om-schrijving	Prijs
		mm	inch	mm		€
160720108	920020A-C	O935202	1/2	P90320	75mm	7,60
160720207	920021A-C	O935202	1/2	P90320	125mm	10,20
160720306	920023A-C	O935202	1/2	P90320	250mm	21,20
160720405	920030A-C	O93528	1/2	P90328	universele aansluiting	18,90
160720504	920037A-C	O935202	1/2	P90320	adaptor 1/2" - 3/4"	10,30
160940102	980036A-C	O92413	3/8	P902515	adaptor 3/8" - 1/2"	7,20

TENGOOLS



Verlengstukken voor slagdoppen. Zonder kogel.

Order nr.	Orig. nr.	O-ringen	Pin nummer	Lengte	Aansluiting inwendig	Prijs
				mm	inch	€
116690058	980020	O92416	P902515	75	3/8	9,40
116690405	920020	O935202	P90320	75	1/2	8,90
116690504	920021	O935202	P90320	125	1/2	12,00
116690603	920023	O935202	P90320	250	1/2	21,20
116691106	940022	O93538	P90437	175	3/4	29,20

TENGOOLS



Vasthouding voor slagdoppen. Om slagdoppen en gereedschappen op slagmoersleutels met geperforeerd aansluitvierkant te bevestigen. Zorgt ervoor dat de bevestigingspin niet uit het aansluitvierkant kan vallen.

Order nr.	Orig. nr.	Diameter x dikte	Prijs
		mm	€
116740051	O92416	16x2,4	0,60
116740085	O92419	19x2,4	0,60
116740101	O935202	20x3,5	1,00
116740200	O93525	25x3,5	1,00
116740309	O93528	28x3,5	1,00
116740333	O93530	30x3,5	1,00
116740358	O93532	32x3,5	1,10
116740382	O93534	34x3,5	1,10
116740408	O93538	38x3,5	1,10
116740507	O93546	46x3,5	1,40
116740606	O93548	48x3,5	1,40
116740705	O970055	75x5,7	2,40

TENGOOLS



Torsiestaafset in TC-tray. Voor het vastzetten van wielmoeren.

Bevat:

- 4 torsiestaven variërend van 90-140 Nm
- 1 adaptor
- 3 slagdoppen voorzien van een kunststof beschermingshuls voor gebruik bij o.a. alu-velgen.

Order nr.	172470403		
Orig. nr.	TTTS08		
Adaptor	inch	3/8 x 1/2	
Verlengstukken	Nm	1/2" 90-110-120-140	
Doppen 1/2"	mm	17-19-21	
Prijs	€	76,50	

TENGOOLS



Vasthoudpin voor slagdoppen. Om slagdoppen en gereedschappen op slagmoersleutels met geperforeerd aansluitvierkant te bevestigen.

Order nr.	Orig. nr.	Diameter x lengte mm	Prijs €
116750050	P902515	2,5x15	1,00
116750084	P902518	2,5x18	1,00
116750100	P90320	3x20	1,00
116750209	P90324	3x24	1,00
116750308	P90328	3x28	1,00
116750357	P90332	3x32	1,00
116750407	P90437	4x37	1,00
116750506	P90543	5x43	1,90
116750605	P90675	6x75	5,70

TENGOOLS



Slagdrop 1/4" aansluiting 6-kant. Chroom molybdeen kwaliteit. Lengte 21mm.

Order nr.	Orig. nr.	Maat mm	Prijs €
132430109	960506-C	6	2,60
132430208	960507-C	7	2,60
132430307	960508-C	8	2,60
132430406	960510-C	10	2,90
132430505	960513-C	13	3,10

TENGOOLS



Slagdoppen 3/8" hex chroom molybdeen kwaliteit. L.52mm.

Order nr.	Orig. nr.	Maat mm	O-ringen Nr.	Pin nummer	Prijs €
151430105	981504-C	4	O935202	P90320	8,60
151430204	981505-C	5	O935202	P90320	8,60
151430303	981506-C	6	O935202	P90320	9,10
151430402	981507-C	7	O935202	P90320	8,60
151430501	981508-C	8	O935202	P90320	8,60
151430600	981510-C	10	O935202	P90320	9,20
151430709	981512-C	12	O935202	P90320	9,20

TENGOOLS



Slagdoppen 3/8" 6-kant. Conform ANSI-standard. Korte versie L. 30mm. mm-uitvoering. chroom molybdeen kwaliteit. De doppen zijn voorzien van een opening voor de vasthoudpin.

Order nr.	Orig. nr.	Maat mm	Prijs €
114830102	980508	8	2,80
114830201	980510	10	3,00
114830300	980511	11	3,00
114830409	980512	12	3,00
114830508	980513	13	3,10
114830607	980514	14	3,80
114830706	980516	16	4,20
114830805	980517	17	4,20
114830904	980519	19	4,50

TENGOOLS



Slagdoppen 3/8" 6-kant. Conform ANSI-standard. Lange versie L. 65mm. mm-uitvoering. chroom molybdeen kwaliteit. De doppen zijn voorzien van een opening voor de vasthoudpin.

Order nr.	Orig. nr.	Maat mm	Prijs €
114860109	980608	8	4,40
114860208	980610	10	4,80
114860307	980611	11	4,80
114860406	980612	12	4,80
114860505	980613	13	5,00
114860604	980614	14	5,30
114860703	980616	16	5,50
114860802	980617	17	5,50
114860901	980619	19	5,80

TENGOOLS



Extra lange slagdrop. Chroom molybdeen.

Order nr.	231430109	231360108
Orig. nr.	940732C	910732
Maat	mm 32	32
Lengte	mm 400	270
Aansluiting	inch 3/4	1
Prijs	€ 70,50	83,80

TENGOOLS



Slagdroppen 1/2" 6-kant. Conform DIN-standard. Korte versie. mm en inch uitvoering. chroom molybdeen kwaliteit. De doppen zijn voorzien van een opening voor de vasthoudpin met sleuf voor ring. (Dit zijn de losse doppen uit de Teng Tray TT9120D).

Order nr.	Orig. nr.	Maat	O-ringen	Pin	Lengte	Maat	Prijs
		mm	Nr.	nummer	mm	inch	€
101780021	920508-C	8	O935202	P90320	38		5,40
101780039	920510	10	O935202	P90320	38		5,40
101780062	920511	11	O935202	P90320	38		5,40
101780096	920512	12	O935202	P90320	38		5,60
101780104	920513	13	O935202	P90320	38		6,80
101780153	920514	14	O935202	P90320	38		6,80
101780203	920515	15	O93525	P90324	38		7,90
101780302	920516	16	O93525	P90324	38		6,60
101780401	920517	17	O93525	P90324	38		7,90
101780500	920518	18	O93525	P90324	38		7,60
101780609	920519	19	O93525	P90324	38		7,90
101780633	920520	20	O93525	P90324	38		6,30
101780658	920521	21	O93525	P90324	38		6,60
101780708	920522	22	O93525	P90324	38		8,30
101780757	920523	23	O93525	P90324	38		6,80
101780807	920524	24	O93525	P90324	38		10,30
101780815	920525-C	25	O93525	P90324	45		10,30
101780823	920526-C	26	O93525	P90324	50		9,20
101780831	920527-C	27	O93525	P90324	50		9,20
101780849	920528-C	28	O93525	P90324	50		9,40
101780856	920529-C	29	O93525	P90324	50		10,10
101780864	920530-C	30	O93525	P90324	50		12,50
101780872	920532	32	O93525	P90324	50		13,20
114870108	920114		O935202	P90320	38	7/16	4,80
114870207	920116		O935202	P90320	38	1/2	4,80
114870306	920118		O935202	P90320	38	9/16	4,80
114870405	920120		O935202	P90320	38	5/8	5,40
114870504	920122		O935202	P90320	38	11/16	5,40
114870603	920124		O935202	P90320	38	3/4	5,80
114870702	920126		O935202	P90320	38	13/16	6,10
114870801	920128		O935202	P90320	38	7/8	6,60
114870900	920130		O93530	P90328	38	15/16	7,00
114871007	920132		O93532	P90328	38	1	7,20

TENGOOLS



Slagdroppen 1/2" 6-kant. Conform DIN-standard. Lange versie. mm en inch uitvoering. L. 78mm. chroom molybdeen kwaliteit. De doppen zijn voorzien van een opening voor de vasthoudpin met sleuf voor ring. (Dit zijn de losse doppen uit de Teng Tray TT9120D).

Order nr.	Orig. nr.	Maat	O-ringen	Pin	Maat	Prijs
		mm	Nr.	nummer	inch	€
101780930	920610	10	O935202	P90320		7,90
101780963	920611	11	O935202	P90320		7,90
101780997	920612	12	O935202	P90320		7,90
101781003	920613	13	O935202	P90320		10,00
101781052	920614	14	O935202	P90320		7,90
101781102	920615	15	P93525	P902324		9,50
101781201	920616	16	O93525	P902324		9,50
101781300	920617	17	O93525	P902324		12,00
101781409	920618	18	O93525	P902324		9,50
101781508	920619	19	O93525	P902324		12,00
101781557	920621	21	O93525	P902324		12,00
101781607	920622	22	O93525	P902324		12,50
101781706	920624	24	O93525	P902324		14,30
101781805	920627	27	O93525	P902324		15,90
101781904	920628	28	O93525	P902324		12,50
101782001	920629	29	O93525	P902324		13,20
101782100	920630	30	O93525	P902324		16,60
101782209	920632	32	O93525	P902324		13,60
101782308	920635	35	O93525	P902324		21,20
101782407	920636	36	O93525	P902324		21,20
114872005	920214		O935202	P90320	7/16	7,10
114872104	920216		O935202	P90320	1/2	7,10
114872203	920218		O935202	P90320	9/16	7,40
114872302	920220		O935202	P90320	5/8	8,10
114872401	920222		O935202	P90320	11/16	8,60
114872500	920224		O935202	P90320	3/4	8,70
114872609	920226		O935202	P90320	13/16	9,20
114872708	920228		O935202	P90320	7/8	10,10
114872807	920230		O93530	P93028	15/16	10,80
114872906	920232		O93532	P93028	1	11,10
114873003	920242		O93534	P93032	1 5/16	15,50
114873102	920248		O93534	P93032	1 1/2	18,20

TENGTOLS



Slagdoppen 1/2" 6-kant. Conform ANSI-standaard. Korte en lange versie. Mm-uitvoering. chroom molybdeen kwaliteit. Dunwandig. (Dit zijn de losse doppen uit de Teng Tray TT9116).

Order nr.	Orig. nr.	Maat mm	Lengte mm	Prijs €
132450057	920510A	10	38	4,00
132450073	920511A	11	38	4,00
132450081	920512A	12	38	4,00
132450107	920513A	13	38	3,90
132450156	920514A	14	38	4,00
132450206	920515A	15	38	4,40
132450305	920516A	16	38	5,80
132450404	920517A	17	38	4,60
132450503	920518A	18	38	5,80
132450602	920519A	19	38	6,30
132450651	920521A	21	38	5,40
132450701	920522A	22	38	5,40
132450800	920524A	24	38	7,10
132440058	920610A	10	78	6,20
132440074	920611A	11	78	6,20
132440082	920612A	12	78	6,20
132440108	920613A	13	78	6,20
132440157	920614A	14	78	6,50
132440207	920615A	15	78	6,60
132440306	920616A	16	78	6,60
132440405	920617A	17	78	6,60
132440504	920618A	18	78	6,60
132440603	920619A	19	78	7,20
132440652	920621A	21	78	8,30
132440702	920622A	22	78	8,00
132440801	920624A	24	78	10,50

TENGTOLS



Slagdoppen 1/2" 6-kant. Conform ANSI-standaard. Korte en lange versie. Mm-uitvoering. chroom molybdeen kwaliteit. Dunwandig. (Dit zijn de losse doppen uit de Teng Tray TT9116).

Order nr.	Orig. nr.	Maat mm	Lengte mm	Prijs €
132450057	920510A	10	38	4,00
132450073	920511A	11	38	4,00
132450081	920512A	12	38	4,00
132450107	920513A	13	38	3,90
132450156	920514A	14	38	4,00
132450206	920515A	15	38	4,40
132450305	920516A	16	38	5,80
132450404	920517A	17	38	4,60
132450503	920518A	18	38	5,80
132450602	920519A	19	38	6,30
132450651	920521A	21	38	5,40
132450701	920522A	22	38	5,40
132450800	920524A	24	38	7,10
132440058	920610A	10	78	6,20
132440074	920611A	11	78	6,20
132440082	920612A	12	78	6,20
132440108	920613A	13	78	6,20
132440157	920614A	14	78	6,50
132440207	920615A	15	78	6,60
132440306	920616A	16	78	6,60
132440405	920617A	17	78	6,60
132440504	920618A	18	78	6,60
132440603	920619A	19	78	7,20
132440652	920621A	21	78	8,30
132440702	920622A	22	78	8,00
132440801	920624A	24	78	10,50

TENGTOLS



Slagdoppen 1 1/2 6-kant.

Order nr.	Orig. nr.	Maat mm	Lengte mm	Prijs €
172840100	912041	41	69	128,40
172840209	912046	46	75	128,40
172840308	912050	50	80	134,10
172840407	912055	55	86	149,00
172840506	912060	60	91	162,70
172840605	912065	65	97	170,80
172840704	912070	70	104	199,40
172840803	912075	75	110	212,00
172840902	912080	80	116	243,00
172841009	912085	85	123	256,70
172841108	912090	90	129	401,10
172841207	912095	95	136	629,20
172841306	912100	100	142	812,50
172841405	912105	105	148	853,80
172841304	912110	110	154	938,60
172841403	912115	115	161	995,90
172841502	912120	120	167	1.025,70
172841601	912125	125	173	1.071,50
172841700	912130	130	180	1.087,60

TENGTOLS



Slagdoopbitsen 1/2" hex voor interne openingen. Lange versie L.78mm. Chroom molybdeen kwaliteit. De doppen zijn voorzien van een opening voor de vasthoudpin.

Order nr.	Orig. nr.	Maat mm	O-ringen Nr.	Pin nummer	Prijs €
151420106	921505-C	5	O935202	P90320	12,50
151420205	921506-C	6	O935202	P90320	12,50
151420304	921508-C	8	O935202	P90320	12,50
151420403	921510-C	10	O935202	P90320	13,20
151420502	921512-C	12	O935202	P90320	13,20
151420601	921514-C	14	O935202	P90320	13,20
151420700	921517-C	17	O935202	P90320	13,60
151420809	921519-C	19	O935202	P90320	13,60

TENGTOLS



Slagdoopbitsen TX 1/2". Lange versie L.78mm. chroom molybdeen kwaliteit. De doppen zijn voorzien van een opening voor de vasthoudpin.

Order nr.	Orig. nr.	O-ringen Nr.	Pin nummer	Maat TX	Prijs €
128140100	921210TX-C	O935202	P90320	10	12,50
128140209	921215TX-C	O935202	P90320	15	12,00
128140308	921220TX-C	O935202	P90320	20	12,00
128140407	921225TX-C	O935202	P90320	25	12,00
128140506	921227TX-C	O935202	P90230	27	12,00
128140605	921230TX-C	O935202	P90230	30	13,60
128140704	921240TX-C	O935202	P90230	40	13,60
128140803	921245TX-C	O935202	P90230	45	11,50
128140902	921250TX-C	O935202	P90230	50	11,50
128141009	921255TX-C	O935202	P90230	55	12,00
128141108	921260TX-C	O935202	P90230	60	12,00
128141207	921270TX-C	O935202	P90230	70	12,00

TENGOOLS



Torsiestaaf. Voor het vastzetten van wielmoeren met slagmoeraanzetters.

Order nr.	Orig. nr.	Voor moer Nm	Kant inch	Prijs €
172510109	923090	90	1/2	17,80
172510208	923110	110	1/2	17,80
172510307	923120	120	1/2	17,80
172510406	923140	140	1/2	17,80

TENGOOLS



1/2dr. 17x19mm slagdrop en 21x22mm slagdrop

Order nr.	Orig. nr.	Maat mm	O-ringen Nr.	Pin nummer	Lengte mm	Prijs €
178720108	9291719	17	19	21	22	9,60
178720207	9292122	21	22	28	32	10,50

TENGOOLS



Slagdoppen 3/4" 6-kant metrisch. Conform DIN-standaard. Korte en lange versie. Chroom molybdeen kwaliteit. De doppen zijn voorzien van een opening voor de vasthoudpin.

Order nr.	Orig. nr.	Maat mm	O-ringen Nr.	Pin nummer	Lengte mm	Prijs €
114880107	940519	19	O93538	P90437	50	15,50
114880156	940521	21	O93538	P90437	50	15,50
114880172	940522	22	O93538	P90437	50	15,50
114880198	940523	23	O93538	P90437	50	15,50
114880206	940524	24	O93538	P90437	52	15,50
114880305	940527	27	O93538	P90437	52	16,60
114880404	940528	28	O93538	P90437	52	15,50
114880503	940530	30	O93538	P90437	52	20,10
114880602	940532	32	O93538	P90437	52	20,50
114880701	940533	33	O93538	P90437	56	16,60
114880800	940534	34	O93538	P90437	56	16,60
114880909	940536	36	O93538	P90437	56	20,50
114881006	940538	38	O93538	P90437	56	18,20
114881105	940541	41	O93538	P90437	58	28,50
114881204	940546	46	O93538	P90437	63	35,00
114890106	940619	19	O93538	P90437	95	24,00
114890155	940621	21	O93538	P90437	95	24,00
114890171	940622	22	O93538	P90437	95	24,00
114890197	940623	23	O93538	P90437	95	24,00
114890205	940624	24	O93538	P90437	95	24,00
114890304	940627	27	O93538	P90437	95	24,00
114890403	940630	30	O93538	P90437	95	27,40
114890502	940632	32	O93538	P90437	95	24,00
114890601	940633	33	O93538	P90437	95	25,10
114890700	940634	34	O93538	P90437	95	25,10
114890809	940636	36	O93538	P90437	95	27,40
114890908	940638	38	O93538	P90437	95	29,20
114891005	940641	41	O93538	P90437	95	31,50
114891104	940646	46	O93538	P90437	95	38,80

TENGOOLS



Slagdropbits 3/4" Hex. chroom-molybdeen kwaliteit. Voor interne hex openingen. L.90mm.

Order nr.	Orig. nr.	Maat mm	O-ringen Nr.	Pin nummer	Prijs €
143980100	941519C	19	O93538	P90437	38,80
143980209	941522C	22	O93538	P90437	38,80
143980308	941524C	24	O93538	P90437	39,50

TENGOOLS



Slagdoppen 1" 6-kant. Conform DIN-standaard. Korte versie. mm-uitvoering. chroom molybdeen kwaliteit. De doppen zijn voorzien van een opening voor de vasthoudpin.

Order nr.	Orig. nr.	Maat mm	O-ringen Nr.	Pin nummer	Lengte mm	Prijs €
114900103	910524	24	O93546	P90543	58	24,60
114900202	910527	27	O93546	P90543	58	24,60
114900301	910530	30	O93546	P90543	60	28,50
114900400	910532	32	O93546	P90543	60	25,80
114900509	910533	33	O93546	P90543	60	24,60
114900608	910534	34	O93546	P90543	60	24,60
114900707	910536	36	O93546	P90543	65	24,60
114900806	910538	38	O93546	P90543	65	25,10
114900905	910541	41	O93546	P90543	67	26,90
114901002	910546	46	O93546	P90543	74	31,50
114901101	910550	50	O93546	P90543	80	35,00
114901200	910555	55	O93546	P90543	84	44,60
114901309	910560	60	O93546	P90543	87	53,70
114901408	910565	65	O93546	P90543	90	60,60
114901507	910570	70	O93546	P90543	96	88,10
114901606	910575	75	O93546	P96075	98	98,00
114901705	910580	80	O95775	P96075	100	129,50
114901804	910585	85	O95775	P96075	100	122,60
114901903	910590	90	O95775	P96075	105	151,30
114902000	910595	95	O95775	P96075	105	168,50

TENGOOLS



Slagdoppen 1" 6-kant metrisch. Lange versie. L.100mm. chroom molybdeen kwaliteit.

Order nr.	Orig. nr.	Maat mm	O-ringen Nr.	Pin nummer	Prijs €
114920101	910627R	27	O93546	P90543	31,50
114920200	910630R	30	O93546	P90543	31,50
114920309	910632R	32	O93546	P90543	31,50
114920408	910633R	33	O93546	P90543	31,50

TENGOOLS



Slagdoppen 1". Dunwandig model. Lange versie L.100mm. 6-kant metrisch. chroom molybdeen kwaliteit.

Order nr.	Orig. nr.	Maat mm	O-ringen Nr.	Pin nummer	Prijs €
114910102	910624	24	O93546	P90543	44,60
114910201	910627	27	O93546	P90543	44,60
114910300	910630	30	O93546	P90543	44,60
114910409	910632	32	O93546	P90543	44,60
114910508	910633	33	O93546	P90543	44,60
801200375	TT910634	34	O93546	P90543	45,70
114910607	910636	36	O93546	P90543	44,60

DOPPENSETS

De nieuwe generatie doppensets biedt u een koffer met voordelen die uw dagelijkse werk zullen vergemakkelijken. Bij het ontwerp van de nieuwe koffer hebben we de nadruk gelegd op handigheid, duurzaamheid en gemak van transport. Bovendien oogt hij mooi ...

- Inklapbaar handvat speciaal ontworpen voor comfort en duurzaamheid
- Verbeterd vergrendelingsysteem met click lock mechanisme, om zeker te zijn dat uw koffer goed dicht is
- Verdelaars beschermen de werktuigen en kunnen dankzij een scharnier gedraaid worden, voor een gemakkelijke toegang tot de werktuigen
- Sterke scharnieren met metalen staven voor een langere duurzaamheid
- Mooie reliëfmarkering om met uw Teng Tools set uit te pakken
- Rubberen voeten om glijden en krassen te vermijden
- Duidelijke en eenvoudige indeling van de werktuigen, zodat u rechtstreeks kunt zien welke ontbreken na het einde van een werk
- Volledig recycleerbare verpakking voor milieubescherming





Get organised™



Doppensets 1/4"

TENGOOLS



19-delige mini doppenset 1/4" 6-kant.

Bestaande uit:

- 6 doppen 1/4" gaande van 8 tot 13mm
- 1 mini-handratel 1/4"
- 1 bitshouder
- 10 bitsen

Geleverd in een kunststof doos met klikslot.

Order nr.	167340108	
Orig. nr.	T1419	
Aantal stuks	19	
Bitsen plat	mm	4,5 - 5,5 - 6,5
Bitsen PH	1 - 2	
Bitsen PZ	1 - 2	
Bitsen Hex	mm	4 - 5 - 6
Doppen 1/4" 6-kant	mm	8 - 9 - 10 - 11 - 12 - 13
Prijs	€	26,50

TENGOOLS



20-delige mini doppenset 1/4".

Bestaande uit:

- 7 doppen 1/4" 6-kant gaande van 5,5 tot 13mm
- 1 mini-handratel 1/4"
- 1 bitshouder
- 10 bitsen

Geleverd in een kunststof doos met klikslot.

Order nr.	167350107	
Orig. nr.	T1420	
Aantal stuks	20	
Bitsen plat	mm	4,5 - 5,5 - 6,5
Bitsen PH	1 - 2	
Bitsen TX	10 - 15 - 20	
Bitsen PZ	1 - 2	
Doppen 1/4" 6-kant	mm	5,5 - 6 - 7 - 8 - 9 - 10 - 13
Prijs	€	26,90

TENGOOLS



23-delige mini doppenset 1/4" 6-kant.

Bestaande uit:

- 9 doppen 1/4" gaande van 4 tot 13mm
- 1 mini bitsratel
- 1 schroefsleutel 100mm
- 1 verlengstuk L. 50mm
- 10 bitsen.

Geleverd in een kunststof doos met klikslot.

Order nr.	167330109	
Orig. nr.	T1423	
Aantal stuks	23	
Bitsen plat	mm	4 - 5,5 - 6,5
Bitsen PH	1 - 2	
Bitsen TX	10 - 15 - 20	
Bitsen PZ	1 - 2	
Doppen 1/4" 6-kant	mm	4 - 5 - 5,5 - 6 - 7 - 8 - 10 - 12 - 13
Accessoires 1/4"	2" verlengstuk · 1/4 bitsratel · 1/4 M: 1/4 hex adaptor	
Sleutels	inch	schroefsleutel 4"
Prijs	€	35,90

TENGOOLS



24-delige Mini doppenset 1/4".

Bestaande uit:

- 11 doppen 1/4" 6-kant gaande van 4 tot 13mm
- 1 mini-handratel 1/4"
- 1 verlengstuk L.75mm
- 1 bitshouder
- 10 bitsen.

Geleverd in een kunststof doos met klikslot.

Order nr.	167920107	
Orig. nr.	T1424	
Aantal stuks	24	
Bitsen plat	mm	4 - 5,5
Bitsen PH	1 - 2	
Bitsen Hex	3 - 5 - 6	
Bitsen TX	10 - 15 - 20	
Doppen 1/4"	mm	4 - 5 - 5,5 - 6 - 7 - 8 - 9 - 10 - 11 - 12 - 13
Prijs	€	28,90

TENGTOOLS



24-delige toolset met 1/4" aansluiting.

Bevat:

- 10 gewone doppen
- 3" verlengstuk
- 72 tanden flexibele ratel
- Koppeling adapter
- Universele verbinding
- 10 bitsen

Order nr.	186901005		
Orig. nr.	T1424S		
Aantal stuks	24		
Doppen 1/4" 6-kant	mm	4, 5, 5.5, 6, 7, 8, 10, 11, 12, 13	
Accessoires 1/4"		72 tanden flexibele ratel, adapter, verlengstuk	
Bitsen lengte 25mm - 1/4"	mm	75 mm	
Hex		plat 3, 4, 5.5, mm TX10, TX15, TX20, TX25, TX27, TX30, TX40 hex 3, 4, 5, 6 mm	
Prijs	€	35,50	

TENGTOOLS

AF / INCH



35-delige doppenset 1/4".

Bestaande uit:

- 9 korte en 6 lange AF doppen 1/4" 6-kant gaande van 3/16" to 1/2"
- 1 ratel 1/4" FRP1400
- 1 elleboogstuk
- 2 verlengstukken L. 50mm en L. 100mm
- 1 T-hendel 1/4"
- 3 hex-sleutels 1,5-2.5mm
- 1 bitshouder
- 11 bitsen

Geleverd in een kunststof doos met klikslot.

Order nr.	172470205		
Orig. nr.	T1435AF		
Aantal stuks	35		
Bitsen plat	mm	4 - 5,5	
Bitsen PH		1 - 2	
Doppen 1/4"	mm	3/16-7/32-1/4-9/32-5/16-11/32-3/8-7/16-1/2	
Bitsen PZ		1 - 2	
Bitsen Hex	mm	5 - 6	
Doppen 1/4" lang	mm	3/16-1/4-5/16-3/8-7/16-1/2	
Bitsen PX		10 - 15 - 20	
Prijs	€	41,50	

TENGTOOLS



36-delige doppenset 1/4" 6-kant.

Bestaande uit:

- 10 korte en 6 lange doppen 1/4" gaande van 4 tot 13mm
- 1 ratel 1/4"
- 1 elleboogstuk
- 2 verlengstukken L.50mm en L.100mm
- 3 hex-sleutels 1,5 - 2,5mm
- 1 bitshouder
- 1 adaptor 3/8"F-1/4"M
- 11 bitsen.

Geleverd in een kunststof doos met klikslot.

Order nr.	167290105		
Orig. nr.	T1436		
Aantal stuks	36		
Bitsen plat	mm	4 - 5,5	
Bitsen PH		1 - 2	
Bitsen Hex		5 - 6	
Bitsen TX		10 - 15 - 20	
Bitsen PZ		1 - 2	
Doppen 1/4" 6-kant	mm	4 - 5 - 5.5 - 6 - 7 - 8 - 10 - 11 - 12 - 13	
Doppen 1/4" 6-kant lang	mm	6 - 7 - 8 - 10 - 12 - 13	
Sleutels Hex	mm	1,5 - 2 - 2,5	
Prijs	€	37,50	

TENGTOOLS



1/4" doppenset - 13 delig.

Kenmerken:

- Met universele Teng Tools ratel met 45-tanden aandrijfmechanisme
- In gepatenteerde vezelversterkte uitvoering.
- Ratel en doppen in handige pocket model doppendoos.

Order nr.	186110102		
Orig. nr.	M1413N1		
Aantal stuks	13		
Doppen 6-kant		4, 5, 5.5, 6, 7, 8, 9, 10, 11, 12, 13	
Verlengstuk 1/4"	mm	50	
Ratel 45 tanden		1/4"	
Prijs	€	27,50	

TENGOOLS



AF / INCH

60-delige AF en mm doppenset 1/4" 6-kant.

Bestaande uit:

- 21 korte doppen 1/4" gaande van 4 tot 13mm en van 3/16" tot 1/2"
- 11 lange doppen 1/4" gaande van 6 tot 13mm en van 1/4" tot 1/2"
- 18 dopbitsen 1/4"
- 1 ratel 1/4"
- 1 elleboogstuk
- 2 verlengstukken 50x100mm
- 1 schroevendraaier met 1/4" en een adaptor 3/8"F-1/4"M en een T-bar

Geleverd in een kunststof doos met dubbel klikslot.

Order nr.	167260108	
Orig. nr.	T1460	
Aantal stuks	60	
Bitsen plat	mm	4 - 5,5
Bitsen PH	1 - 2	
Bitsen TX	10 - 15 - 20	
Bitsen PZ	1 - 2	
Bitsen Hex	mm	5 - 6
Doppen 1/4" 6-kant lang	mm	6 - 7 - 8 - 10 - 12 - 13
Doppen 1/4" 6-kant	mm	4 - 4,5 - 5 - 5,5 - 6 - 7 - 8 - 9 - 10 - 11 - 12 - 13
Doppen 1/4" 6-kant	inch	3/16 - 7/32 - 1/4 - 9/32 - 5/16 - 11/32 - 3/8 - 7/16 - 1/2
Doppen 1/4" 6-kant lang	inch	1/4 - 5/16 - 3/8 - 7/16 - 1/2
Dopbitsen 1/4" plat	mm	4 - 5,5 - 7
Dopbitsen 1/4" TX	10 - 15 - 20 - 25 - 27	
Dopbitsen 1/4" PH	1 - 2	
Prijs	€	86,50

Doppensets 3/8"

TENGOOLS



34-delige doppenset 3/8" 6-kant.

Bestaande uit:

- 9 korte doppen 3/8" gaande van 8 tot 19mm
- 1 adaptor 1/2"F - 3/8"M
- 2 verlengstukken 75x150mm
- 1 ratel
- 20 bitsen

Geleverd in een kunststof koffer met dubbel klikslot.

Order nr.	167310101	
Orig. nr.	T3834	
Aantal stuks	34	
Doppen 3/8" 6-kant	mm	8 - 10 - 11 - 12 - 13 - 14 - 15 - 17 - 19
Bitsen plat	mm	3 - 4 - 5,5
Bitsen TX	10 - 15 - 20 - 25 - 27 - 30 - 40	
Bitsen PH	1 - 2 - 3	
Bitsen PZ	1 - 2 - 3	
Bitsen Hex	mm	3 - 4 - 5 - 6
Prijs	€	40,50

TENGOOLS



39-delige doppenset 3/8".

Bestaande uit:

- 14 korte en 6 lange doppen 3/8" gaande van 8 tot 21mm
- 2 bougie doppen
- 1 ratel 3/8" FRP3800
- 1 adaptor 3/8"F-1/2"M
- 1 verlengstuk L.150mm
- 1 verlengstuk met bolkop L.75mm
- 1 elleboogstuk
- 11 bitsen.

Geleverd in een kunststof koffer met dubbel klikslot.

Order nr.	167930106	
Orig. nr.	T3839	
Aantal stuks	39	
Doppen 3/8" 6-kant	mm	8 - 9 - 10 - 11 - 12 - 13 - 14 - 15 - 16 - 17 - 18 - 19 - 20 - 22
Bitsen plat	mm	0,8x4 - 1,2x5,5
Bitsen TX	10 - 15 - 20	
Bitsen PH	1 - 2	
Bitsen PZ	1 - 2	
Bitsen Hex	mm	5 - 6
Bougie doppen 3/8" 6-kant	mm	16(5/8") - 21(13/16")
Doppen 3/8" 6-kant lang	mm	8 - 10 - 12 - 13 - 17 - 19
Prijs	€	67,50

TENGOOLS

39-delige doppenset 3/8" 6-kant.

Bestaande uit:

- 14 korte doppen 3/8" gaande van 8 tot 22mm
- 9 steekringsleutels gaande van 8 tot 19mm
- 1 ratel 3/8"
- 1 adaptor 1/2"F-3/8"M
- 1 verlengstuk L. 150mm
- 1 bitshouder
- 1 elleboogstuk
- 11 bitsen

Geleverd in een kunststof koffer met dubbel klikslot.

Order nr.	167280106	
Orig. nr.	T3840	
Aantal stuks	39	
Steekringsleutels	mm	8 - 10 - 11 - 12 - 13 - 14 - 15 - 17 - 19
Doppen 3/8" 6-kant	mm	8 - 9 - 10 - 11 - 12 - 13 - 14 - 15 - 16 - 17 - 18 - 19 - 21 - 22
Bitsen plat	mm	0,8x4mm - 1,2x5,5
Bitsen TX		10 - 15 - 20
Bitsen PH		1 - 2
Bitsen PZ		1 - 2
Bitsen Hex	mm	5 - 6
Prijs	€	91,50

TENGOOLS

67-delige combinatieset 3/8" 6-kant.

Bestaande uit:

- 14 korte doppen 3/8" gaande van 8 tot 19mm
- 10 steekringsleutels gaande van 8 tot 19mm
- 6 schroevendraaiers plat en PH
- 4 tangen
- 1 ratel 3/8"
- 2 verlengstukken L.75 en L.150mm
- 1 adaptor 1/2"F-3/8"M
- 1 elleboogstuk
- 26 bitsen.

Geleverd in een kunststof koffer met dubbel klikslot.

Order nr.	167200104	
Orig. nr.	T3867	
Aantal stuks	67	
Steekringsleutels	mm	8 - 10 - 11 - 12 - 13 - 14 - 15 - 16 - 17 - 18 - 19
Doppen 3/8" 6-kant	mm	8 - 9 - 10 - 11 - 12 - 13 - 14 - 15 - 16 - 17 - 18 - 19 - 20 - 22
Bitsen plat	mm	4 - 5 - 7
Bitsen TX		8 - 10 - 15 - 20 - 25 - 27 - 30 - 40 - 45 - 50
Bitsen PH		0 - 1 - 2 - 3
Bitsen PZ		1 - 2 - 3
Bitsen Hex	mm	3 - 4 - 5 - 6 - 8 - 10
Lange bektang	mm	200
Zijkniptang	mm	150
Combinatie tangen	mm	175
Waterpomptangen	mm	250
Schroevendraaiers Plat	mm	3 - 5,5 - 6
Schroevendraaiers PH		0 - 1 - 2
Lange bektang	mm	200
Prijs	€	186,00

TENGOOLS



48-delige combinatieset 3/8" 6-kant.

Bestaande uit:

- 14 korte doppen 3/8" mm en AF
- 2 bogiedoppen 16 en 21 mm
- 14 steekringsleutels gaande van 8 tot 19 mm
- 6 schroevendraaiers plat en PH
- 5 tangen
- 1 schroefsleutel
- 1 ratel 3/8"
- 2 verlengstukken L.75 en L.150 mm
- 1 adaptor 1/2" F-3/8" M
- 1 elleboogstuk

Geleverd in een kunststof koffer met dubbel klikslot.

Order nr.	167210103 		
Orig. nr.	T3848		
Aantal stuks	48		
Steekringsleutels	mm	8 - 10 - 12 - 13 - 14 - 15 - 16 - 17 - 18 - 19	
Lange bektang	mm	200	
Zijkniptang	mm	150	
Griptang	mm	175	
Combinatie tangen	mm	175	
Waterpomptangen	mm	250	
Schroevendraaiers Plat	mm	0,5x3,0 - 1,0x5,5 - 1,2x6,5	
Schroevendraaiers PH		0 - 1 - 2	
Doppen 3/8" 6-kant lang	mm	8 - 10 - 12 - 13 - 14 - 15 - 16 - 17 - 18 - 19	
Doppen 3/8" 6-kant	inch	7/16 - 1/2 - 9/16 - 11/16	
Bogiedoppen	mm	16 - 21	
Steekringsleutels	inch	7/16 - 1/2 - 9/16 - 11/16	
Schroefsleutel	mm		
Prijs	€	217,00	

AF / INCH

TENGOOLS



35-delige doppen set 3/8".

Bestaande uit:

- 10 korte doppen gaande van 5/16" tot 7/8"
- 6 lange doppen gaande van 3/8" tot 3/4"
- 2 bogiedoppen
- 1 ratel 3/8"
- 2 verlengstukken 100x150 mm
- 1 elleboogstuk
- 1 adaptor 1/2x3/8
- 11 bitsen.

In een kunststof koffer met dubbel klikslot.

Order nr.	172470304 		
Orig. nr.	T3835AF		
Aantal stuks	35		
Bitsen plat	mm	0,8x4 - 1,2x5,5	
Bitsen TX		10 - 15 - 20	
Bitsen PH		1 - 2	
Bitsen PZ		1 - 2	
Bitsen Hex	mm	5 - 6	
Bogiedoppen 3/8" 6-kant	mm	16 - 21	
Doppen 3/8"	inch	5/16 - 3/8 - 7/16 - 1/2 - 9/16 - 5/8 - 11/16 - 3/4 - 11/16 - 7/8	
Doppen 3/8" lang	inch	3/8 - 7/16 - 1/2 - 9/16 - 11/16 - 3/4	
Prijs	€	54,90	

TENGOOLS



79-delige serviceset. In RVS.

Bestaande uit:

- 12 doppen 3/8" 6-kant gaande van 8 tot 22mm
- 1 roestvrije 3/8" ratel
- 1 adaptor 1/2" F-3/8" M
- 4 schroevendraaiers
- 1 rolmeter 5m
- 1 klauwhamer
- 3 tangen
- 1 magnetische bitsschroevendraaier
- 1 zaklamp
- 1 breekmes
- 1 telescopische pick-up magneet zaagbeugel
- 1 allensleutel set
- pin en haken set

Geleverd in een kunststof doos met klikslot.

Order nr.	173360108	
Orig. nr.	TM079	
Aantal stuks	79	
Steekringsleutels	mm	6-7-8-10-11
Doppen 3/8" 6-kant	mm	8-10-11-12-13-14-15-17-19-20-21-22
Bitsen plat	mm	4 - 5,5 - 6
Bitsen TX		10 - 15 - 20 - 25 - 30 - 40
Bitsen PH		1 - 2 - 3
Bitsen PZ		1 - 2 - 3
Bitsen Rob		1 - 2 - 3
Bitsen Hex	mm	4 - 5 - 6
Bitsen GR		2 (2x)
Allensleutels	mm	1,5 - 2,5 - 3 - 4 - 5 - 6
Schroefleutel	mm	200
Lange bektang	mm	150
Zijkniptang	mm	150
Combinatie tangen	mm	175
Waterpomptangen	mm	175
Schroevendraaiers Plat	mm	3 - 5,3
Schroevendraaiers PH		1 - 2
Bitsen TPX		20 - 25 - 30
Prijs	€	257,00

TENGOOLS



34-delige doppen set met 3/8" aansluiting. 8-19mm.

Bevat:

- 72 tanden flexibele ratel
- 9 gewone doppen
- 3" en 6" verlengstukken
- Universele verbinding
- 20 bitsen

Order nr.	186901104	
Orig. nr.	T3834S	
Aantal stuks	34	
Doppen 3/8" 6-kant	mm	8, 10, 11, 12, 13, 14, 15, 17, 19
Bitsen lengte 25mm - 1/4"	mm	3mm plat, 4mm plat, 5.5mm plat TX10, TX15, TX20, TX25, TX27, TX30, TX40 3mm hex, Hex
Hex	mm	4mm hex, 5mm hex, 6mm hex PH1, PH2, PH3, PZ1, PZ2, PZ3
Prijs	€	46,90

TENGOOLS



12-delige doppen set 3/8".

Kenmerken:

- Met universele Teng Tools ratel met 45-tands aandrijfmechanisme.
- In gepatenteerde vezelversterkte uitvoering.
- Ratel en doppen in handige pocket model doppendoos.

Order nr.	185990108	
Orig. nr.	M3812N1	
Aantal stuks	12	
Doppen 6-kant	mm	8, 10, 11, 12, 13, 14, 15, 16, 17, 19
Verlengstuk 3/8"	mm	75
Ratel 45 tanden		3/8"
Prijs	€	31,50

Doppensets 1/2"

TENGTTOOLS



21-delige doppenset 1/2".

Bestaande uit:

- 16 korte doppen 1/2" gaande van 10 tot 32mm
- 1 ratel 1/2"
- 2 verlengstukken L.65 en L.150mm
- 1 elleboogstuk
- 1 adaptor 1/2"F-3/8"M

Geleverd in een kunststof koffer met dubbel klikslot.

Order nr.	167240100	167240209
Orig. nr.	T1221	T1221-6
Aantal stuks	21	21
Type dop	12kant	6-kant
Doppen 1/2" mm	10 - 11 - 12 - 13 - 14 - 15 - 16 - 17 - 18 - 19 - 21 - 22 - 24 - 27 - 30 - 32	10 - 11 - 12 - 13 - 14 - 15 - 16 - 17 - 18 - 19 - 21 - 22 - 24 - 27 - 30 - 32
Prijs	€ 83,50	83,50

TENGTTOOLS

AF / INCH



21-delige doppenset 1/2" 12-kant.

Bestaande uit:

- 15 korte AF-doppen 1/2" gaande van 3/8" tot 1 1/4"
- 1 ratel 1/2" 1200FRP
- 2 verlengstukken L.65mm en L.150mm
- 1 elleboogstuk
- 1 adaptor 3/8"F-1/2"M

Geleverd in een kunststof koffer met dubbel klikslot.

Order nr.	17240106
Orig. nr.	T1220AF
Aantal stuks	21
Type dop	12kant
Doppen 1/2" inch	3/8 - 7/16 - 1/2 - 9/16 - 5/8 - 11/16 - 3/4 - 13/16 - 7/8 - 15/16 - 1 - 11/16 - 11/8 - 1 3/16 - 1 1/4
Prijs	€ 84,50

TENGTOOLS



34-delige doppenset 1/2".

Bestaande uit:

- 16 korte doppen 1/2" en 8 lange doppen 1/2" gaande van 11 tot 24mm
- 1 ratel 1/2" 1200FRP
- 2 bougiedoppen 1/2" van 16 en 21mm
- 3 hexsleutels 1,5 - 2 - 2,5mm
- 2 verlengstukken L.125 en L.250mm
- 1 adaptor 3/8"F-1/2"M
- 1 elleboogstuk

Geleverd in een kunststof koffer met dubbel klikslot.

Order nr.	174570101	
Orig. nr.	T1234	
Aantal stuks	34	
Doppen 1/2" 6-kant	mm	10 · 11 · 12 · 13 · 14 · 15 · 16 · 17 · 18 · 19 · 20 · 21 · 22 · 23 · 24 · 27
Doppen 1/2" 6-kant lang	mm	13 · 14 · 15 · 16 · 17 · 18 · 19 · 24
Bougiedoppen 1/2"	mm	16 · 21
Prijs	€	133,00

TENGTOOLS



68-delige doppenset 1/2".

Bestaande uit:

- 16 korte doppen 1/2" 12-kant gaande van 10 tot 32mm
- 1 adaptor 3/8"F-1/2"M
- 1 magnetische bitshouder
- 2 verlengstukken 65x150mm
- 1 ratel
- 1 T-hendel
- 10 steekringsleutels gaande van 8 tot 19 mm
- 6 schroevendraaiers
- 4 tangen
- 26 bitsen

Geleverd in een kunststof koffer met dubbel klikslot.

Order nr.	167580109	
Orig. nr.	T1268	
Aantal stuks	68	
Doppen 1/2" 12-kant		10 · 11 · 12 · 13 · 14 · 15 · 16 · 17 · 18 · 19 · 21 · 22 · 24 · 27 · 30 · 32
Schroevendraaiers Plat	mm	3 · 5,5 · 6,5
Schroevendraaiers PH		0 · 1 · 2 · 3
Zijkniplang	mm	150
Combinatie tangen	mm	175
Lange bektang	mm	200
Waterpomplangen	mm	250
Steekringsleutels	mm	8 · 10 · 11 · 12 · 13 · 14 · 15 · 16 · 17 · 19
Bitsen plat	mm	4 · 5,5 · 7
Bitsen TX		8 · 10 · 15 · 20 · 25 · 27 · 30 · 40 · 45 · 50
Bitsen PH		0 · 1 · 2 · 3
Bitsen PZ		0 · 1 · 2 · 3
Bitsen Hex	mm	3 · 4 · 5 · 6 · 8 · 10
Prijs	€	224,00

TENGTTOOLS



72-delige doppenset 1/4" en 1/2".

Bestaande uit:

- 10 korte doppen 1/4" en 16 korte doppen 1/2" 12-kant gaande van 4 tot 27mm
- 2 ratels 1/4" 1400FRP en 3/8" 3800FRP
- 1 verlengstuk 1/4" L.100mm
- 1 bi-flex sleutel 1/4"hex x 1/4" drive
- 2 verlengstukken 1/2" L.125mm en L.250mm
- 1 elleboogstuk 1/2"
- 1 adaptor 3/8"F-1/2"M
- 1 flex-kopstuk 1/2"
- 33 bitsen

Geleverd in een kunststof koffer met dubbel klikslot.

Order nr.	174580100
Orig. nr.	T1272
Aantal stuks	72
Bitsen plat	mm 4 - 5,5 - 7
Bitsen TX	8 - 10 - 15 - 20 - 25 - 27 - 30 - 40 - 45 - 50
Bitsen PH	0,8x4 - 0 - 1 - 2 - 3
Bitsen PZ	1 - 2 - 3
Doppen 1/4" 6-kant	mm 4 - 5 - 5,5 - 6 - 7 - 8 - 10 - 11 - 12 - 13
Doppen 1/2" 12-kant	mm 10 - 11 - 12 - 13 - 14 - 15 - 16 - 17 - 18 - 19 - 20 - 21 - 22 - 23 - 24 - 27
Bitsen Hex	inch 1/8 - 9/64 - 5/32 - 3/16 - 7/32 - 1/4 - 3/8
Bitsen Ribe	5 - 6
Sleutels Hex	mm 1,5 - 2 - 2,5
Prijs	€ 137,00

NEW
AF / INCH

TENGTTOOLS



Combiset 1/4" - 1/2" 95 dlg.

Bestaande uit:

- Doppen 1/4" kort en diep
- Doppen 1/2"
- Ratels 1/2" en 1/4"
- Accessoires 1/2" en 1/4"
- Bitsen 39 stuks
- Hex sleutels
- Schroevendraaiers Plat-PH-PZ

Geleverd in een stevig kunststof koffer met metalen klikslot. De onderkant van de koffer is voorzien van anti-slip rubberen voetjes.

Order nr.	231330101
Orig. nr.	TM095
Aantal stuks	95
Steekringsleutels	mm 8 - 10 - 12 - 13 - 14 - 17
Doppen 1/4" 6-kant	mm 4 - 4,5 - 5 - 5,5 - 6 - 7 - 8 - 9 - 10 - 11 - 12 - 13
Doppen 1/2" 6-kant	mm 10 - 11 - 12 - 13 - 14 - 15 - 17 - 19 - 22 - 24 - 27 - 30 - 32
Doppen 1/4" 6-kant lang	mm 4 - 5 - 6 - 7 - 8 - 9 - 10 - 11 - 12 - 13
Bitsen lengte 25 mm - 1/4" Hex	plat 4 - 5,5 - 7 mm PH0, PH1, PH2, PH3, PH4 PZ0, PZ1, PZ2, PZ3 HEX 3, 4, 5, 6, 8, 10 mm 1/4"hex; 1/4"M adapter TX8, TX10, TX15, TX20, TX25, TX27, TX30, TX40
Bitsen lengte 30 mm - 5/16" Hex	TX45, TX50, TX55
Sleutels Hex	mm 1,5 - 2 - 2,5 mm
Accessoires 1/4"	FRP-ratel, universele verbinding, verlengstukken 50 en 100 mm, T-handvat 100 mm, adapter 1/4-1/4, 50 mm magnetisch bits handvat
Accessoires 1/2"	FRP-ratel, verlengstukken 125 en 250 mm, adapter 3/8"F-1/2"M, universele verbinding, bougiepomp 21 mm, adapter 1/2"/5/16"
Schroevendraaiers	PH1, PH2, PZ1, PZ2, plat 3, 4 mm
Prijs	€ 174,00

TENGOOLS



106-delige combi superset.

Bestaande uit o.a.:

- Doppen 1/4", 3/8" en 1/2" gaande van 4 tot 32mm, 3/16" tot 1 3/16"
- Bitsen
- Ratels 1/4" en 3/8"
- Elleboogstuk 1/4" en 1/8"
- Verlengstukken
- Adaptors
- 1 bi-flex sleutel 1/4 flex x 1/4 drive
- Bitshouder 1/4
- 1 flex kopstuk 1/2

Geleverd in een kunststof koffer.

Order nr.	167220102	
Orig. nr.	TM106	
Aantal stuks	106	
Steekringsleutels	mm	8 - 9 - 10 - 11 - 12 - 13 - 14 - 15 - 16 - 17 - 18 - 19
Doppen 3/8" 6-kant	mm	8 - 9 - 10 - 11 - 12 - 13 - 14 - 15 - 16 - 17 - 18 - 19 - 21 - 22
Verlengstukken	inch x	1/4x50 - 1/4x75 - 3/8x75 - 3/8x150 - 1/2x63 - 1/2x250
	mm	
Bougiedoppen 3/8"	inch	16 - 21
Doppen 1/4" 6-kant	mm	4 - 5 - 5,5 - 6 - 7 - 8 - 10 - 11 - 12 - 13
Doppen 1/4" 6-kant lang	mm	6 - 7 - 8 - 10 - 12 - 13
Doppen 1/2" 12-kant	mm	19 - 24 - 27 - 30 - 32
Bi-flex sleutels	mm	8x9 - 10x11 - 12x13 - 14x15
Schroefleutels	inch	10
Bitsen lengte 25mm - 1/4" plat	mm	4 - 5,5 - 7
Bitsen lengte 25mm - 1/4" TX		8 - 10 - 15 - 20 - 25 - 27 - 30 - 40
Bitsen lengte 25mm - 1/4" PH		0 - 1 - 2 - 3
Bitsen lengte 25mm - 1/4" TPX		10 - 15 - 20 - 25 - 27 - 30 - 40
Bitsen lengte 25mm - 1/4" Hex	mm	3 - 4 - 5 - 6 - 8 - 10
Bitsen lengte 25mm - 1/4" Ribe		5 - 6
Adaptors M/F	inch	1/2-3/8 - 1/4-3/8 - 3/8-1/2
Prijs	€	225,00

TENGOOLS



111-delige combi-superset.

Bestaande uit o.a.:

- Mm en AF doppen 1/4", 3/8", 1/2" gaande van 4 tot 32 mm en 3/16" tot 1 3/16"
- Bitsen
- Ratels 1/4", 3/8" en 1/2"
- Dopbitschroevendraaier 1/4" en 3/8"
- T-baar
- Diverse accessoires

Geleverd in een kunststof koffer.

Order nr.	167230101	
Orig. nr.	TM111	
Aantal stuks	111	
Doppen 1/4" 6-kant	mm	4 - 5 - 6 - 7 - 8 - 10 - 12
Doppen 1/4" 6-kant	inch	3/16 - 7/32 - 1/4 - 9/32 - 3/8 - 7/16
Doppen 3/8" 6-kant	mm	8 - 9 - 10 - 12 - 13 - 14 - 15 - 16 - 17
Doppen 3/8" 6-kant	inch	3/8 - 7/16 - 1/2 - 9/16 - 11/16 - 3/4 - 13/16 - 7/8
Doppen 3/8" 6-kant lang	mm	8 - 9 - 10 - 12 - 13 - 14 - 15 - 16 - 17
Doppen 3/8" 6-kant lang	inch	3/8 - 7/16 - 1/2 - 9/16 - 11/16 - 3/4 - 13/16 - 7/8
Doppen 1/2" 6-kant	mm	17 - 24 - 27 - 32
Doppen 1/2" 6-kant	inch	11/16 - 3/4 - 13/16 - 7/8 - 1 - 1 1/16
Bougiedoppen 3/8" 6-kant	mm	16 - 21
Verlengstukken	inch x	1/4x150(flex.) - 1/4x50 - 1/4x100 - 3/8x75 - 3/8x150 - 1/2x63 - 1/2x250
	mm	
Adaptor M/F	inch	3/8-1/4 - 1/2-3/8 - 3/8-1/2
Bitsen plat	mm	4 - 5,5 - 7
Bitsen TX		10 - 15 - 20 - 25 - 30 - 40
Bitsen PH		1 - 2 - 3
Bitsen PZ		1 - 2 - 3
Bitsen Hex (1)	mm	3 - 4 - 5 - 6 - 7 - 10
Bitsen Hex (2)	inch	1/8 - 9/64 - 5/32 - 3/16 - 1/4 - 5/16
Bitsen lengte 25mm - 5/16" TX		45 - 50
Prijs	€	238,00

TENGOOLS



30-delige doppenset 1/2" MM en AF 12-kant.

Bestaande uit:

- 1 verlengstuk L.125mm
- 1 adaptor 3/8"F-1/2"M
- 26 doppen 1/2" gemengd AF en MM
- 1 elleboogstuk

Geleverd in een kunststof koffer met dubbel klikslot.

Order nr.	178020103
Orig. nr.	T1230
Aantal stuks	30
Doppen 1/2"	mm 10 · 12 · 13 · 14 · 15 · 16 · 17 · 18 · 19 · 21 · 23 · 24 · 27 · 30 · 32
Adaptor M/F	inch 1/2 · 3/8
Verlengstuk 1/2"	mm 125
Doppen 1/2"	inch 3/8 · 7/16 · 1/2 · 9/16 · 5/8 · 3/4 · 13/16 · 15/16 · 1 1/8 · 1 1/4
Prijs	€ 102,00

TENGOOLS



12-delige doppenset 1/2" 12-kant.

Kenmerken:

- Met universele Teng Tools ratel met 45-tands aandrijfmechanisme.
- In gepatenteerde vezelversterkte uitvoering.
- Ratel en doppen in handige pocket model doppendoos.

Order nr.	186100103
Orig. nr.	M1212N1
Aantal stuks	12
Doppen	10, 12, 13, 14, 15, 17, 18, 19, 24
Verlengstuk 1/2"	mm 125
Ratel 45 tanden	1/2"
Prijs	€ 46,90

Doppensets 3/4"

TENGOOLS



18-delige doppenset 3/4".

Bestaande uit:

- 14 doppen 3/4" 6-kant gaande van 19 tot 50mm
- 1 ratel 3/4" 40 tanden L.500mm
- 1 T-hendel L.450mm
- 2 verlengstukken L.200 en L.400mm

Verpakt in een kunststof koffer.

Order nr.	167380104
Orig. nr.	T3418-6
Aantal stuks	18
Doppen 3/4" 6-kant	mm 19 · 21 · 22 · 24 · 27 · 30 · 32 · 33 · 34 · 36 · 38 · 41 · 46 · 50
Verlengstukken	mm 200 · 400
Prijs	€ 279,00

TENGOOLS

22-delige doppenset 3/4" mm en AF.

Bestaande uit:

- 8 doppen 3/4" 6-kant mm
- 9 doppen 3/4" 12-kant mm/AF gaande van 19 tot 2" (50mm)
- 1 ratel 3/4" L.500mm
- 1 T-hendel L.450mm
- 3 verlengstukken L.100mm, L.200 en L.400mm met safety lock

Geleverd in een kunststof koffer met dubbel klikslot.

Order nr.	167370105 ⓘ		
Orig. nr.	T3422S		
Aantal stuks	22		
Doppen 3/4" 6-kant	mm	19 · 21 · 24 · 27 · 32 · 34 · 36 · 50	
Verlengstukken	mm	100 · 200 · 400	
Doppen 3/4" 12-kant	inch	7/8 · 1 · 1 1/8 · 1 3/16 · 1 5/16 · 1 1/2 · 1 5/8 · 1 13/16 · 2	
Prijs	€	313,00	

Doppensets 1"

TENGOOLS

15-delige doppenset 1".

Bestaande uit:

- 10 doppen 1" 12-kant gaande van 36 tot 80mm
- 1 ratel 1"
- 1 T-hendel L.560mm
- 2 verlengstukken L.200 en L.400mm

Verpakt in een stevige metalen koffer.

Order nr.	73530107 ⓘ		
Orig. nr.	M1115MM		
Aantal stuks	15		
Doppen 1"	mm	36 · 41 · 46 · 50 · 55 · 60 · 65 · 70 · 75 · 80	
Verlengstukken	mm	200 · 400	
Prijs	€	407,00	

Doppensets RVS

TENGTTOOLS



16-delige doppenset 3/8" in RVS.

Bestaande uit:

- 12 doppen 3/8" 6-kant gaande van 8 tot 19mm
- 1 roestvrije 3/8" ratel 36 tanden
- verlengstuk 75x125mm
- 1 adaptor 3/8"F-1/2"M

Geleverd in een kunststof doos met klikslot.

Order nr.	167520105
Orig. nr.	TS3816
Doppen 3/8" 6-kant	mm 8 · 9 · 10 · 11 · 12 · 13 · 14 · 15 · 16 · 17 · 18 · 19
Aantal stuks	16
Prijs	€ 289,00

TENGTTOOLS



18-delige doppenset 1/2" in RVS.

Bestaande uit:

- 12 doppen 1/2" 6-kant gaande van 10 tot 24mm
- 3 lange doppen 1/2" gaande van 17 tot 21mm
- 1 ratel RVS 1/2" 36 tanden
- L 125mm verlengstuk
- 1 adaptor 1/2"F-3/8"M

Geleverd in een kunststof doos met klikslot.

Order nr.	167510106
Orig. nr.	TS1218
Aantal stuks	18
Doppen 1/2" 6-kant	mm 10 · 11 · 12 · 13 · 14 · 15 · 16 · 17 · 18 · 19 · 21 · 24
Doppen 3/8" 6-kant lang	mm 17 · 19 · 21
Prijs	€ 463,00

Doppen op rail 1/4"

TENGOOLS



Set van 12 doppen 6-kant 1/4".

Kenmerken:

- Gaande van 4 tot 13mm.
- Geleverd op een metalen rail met dopclips.

Order nr.	117070102		
Orig. nr.	M1412		
Doppen 1/4"	mm	4 · 4,5 · 5 · 5,5 · 6 · 7 · 8 · 9 · 10 · 11 · 12 · 13	
Prijs	€	12,90	

TENGOOLS



Set van 9 lange doppen 1/4" 6 kant L.50mm.

Kenmerken:

- Gaande van 4 tot 13mm.
- Geleverd op een metalen rail met dopclips.

Order nr.	73090102		
Orig. nr.	M1407		
Doppen 1/4"	mm	4 · 5 · 6 · 7 · 8 · 9 · 10 · 12 · 13	
Prijs	€	18,50	

TENGOOLS



Set van 7 dopbitsen 1/4" TX.

Kenmerken:

- Gaande van TX10 tot TX40.
- Geleverd op een metalen rail met dopclips.

Order nr.	117090209		
Orig. nr.	M1408TX		
Doppen 1/4"	TX	10 · 15 · 20 · 25 · 27 · 30 · 40	
Prijs	€	17,50	

Doppen op rail 3/8"

TENGOOLS



Set van 16 korte 6-kant doppen 3/8".

Kenmerken:

- Gaande van 7 tot 22mm.
- Geleverd op een metalen rail met dopclips.

Order nr.	116660101		
Orig. nr.	M3816		
Doppen 3/8"	mm	7 · 8 · 9 · 10 · 11 · 12 · 13 · 14 · 15 · 16 · 17 · 18 · 19 · 20 · 21 · 22	
Prijs	€	33,90	

TENGOOLS



Set van 7 lange doppen 3/8" 6-kant opening.

Kenmerken:

- Gaande van 10 tot 19mm.
- Buitengrip 6-kant 24mm.
- Geleverd op een metalen rail met dopclips.

Order nr.	73160103		
Orig. nr.	M3807		
Doppen 3/8" 6-kant	mm	10 · 12 · 13 · 14 · 15 · 17 · 19	
Lengte	mm	45 · 65	
Prijs	€	22,90	

TENGOOLS



Set van 9 dopbitsen 3/8" Hex gaande van 3 tot 12mm.

Set van 8 dopbitsen 3/8" AF Hex gaande van 3/32" tot 3/8".

Kenmerken:

- Geleverd op een metalen rail met dopclips.

Order nr.	68830108		68830207	
Orig. nr.	M3812		M3811	
Dopbitsen 3/8"	mm	3 · 4 · 5 · 5,5 · 6 · 7 · 8 · 10 · 12		-
Dopbitsen 3/8"	inch	3/32 · 1/8 · 5/32		3/16 · 7/16 · 1/4 · 5/16 · 3/8
Prijs	€	30,90		30,90

TENGOOLS



Set van 9 dopbitsen 3/8" TX (M3813TX) of TPX (M3813TPX) gaande van TX10 tot TX50.

Kenmerken:

- Geleverd op een metalen rail met dopclips.

Order nr.	68840107	102180106
Orig. nr.	M3813TPX	M3813TX
Dopbitsen 3/8" TPX (1)	10 · 15 · 20 · 25 · 27 · 30 · 40 · 45 · 50	
Dopbitsen 3/8" TX (2)		10 · 15 · 20 · 25 · 27 · 30 · 40 · 45 · 50
Prijs	€ 32,90	29,90

TENGOOLS



Doppenset bestaande uit 5 doppen 1/4" en 5 doppen 3/8" E-TX.

Kenmerken:

- Gaande van TX-E 4 tot 18.
- Geleverd op een metalen rail met dopclips.

Order nr.	04850103
Orig. nr.	M3814
Doppen 1/4"	TXE 4 · 5 · 6 · 7 · 8
Doppen 3/8"	TXE 10 · 12 · 14 · 16 · 18
Prijs	€ 23,90

TENGOOLS



14-delige doppenset 3/8" gaande van 8 tot 19mm.

Kenmerken:

- Roestvrijstaal.
- Geleverd op een metalen rail met dopclips.

Order nr.	162560106
Orig. nr.	MS3814
Verlengstukken	mm 75 · 125
Maat	mm 8 · 9 · 10 · 11 · 12 · 13 · 14 · 15 · 16 · 17 · 18 · 19
Prijs	€ 181,00

Doppen op rail 1/2"

TENGOOLS



Set van 15 doppen 1/2" 12-kant MM en AF.

Kenmerken:

- Geleverd op een metalen rail met dopclips.

Order nr.	28130102	28130201
Orig. nr.	M1215MM	M1215AF
Doppen 1/2"	mm 10 · 12 · 13 · 14 · 15 · 16 · 17 · 18 · 19 · 21 · 22 · 24 · 27 · 30 · 32	3/8 · 7/16 · 1/2 · 9/16 · 5/8 · 11/16 · 3/4 · 13/16 · 7/8 · 15/16 · 1 · 11/16 · 11/8 · 1 3/16 · 1 1/4
Prijs	€ 51,50	52,90

TENGOOLS



Set van 8 lange doppen 1/2" 12-kant gaande van 13 tot 24mm.

Kenmerken:

- Geleverd op een metalen rail met dopclips.
- L. 80mm.

Order nr.	73100109
Orig. nr.	M1207
Doppen 1/2" lang	mm 13 · 14 · 15 · 17 · 19 · 21 · 22 · 24
Prijs	€ 38,90

TENGOOLS



Set van 8 lange doppen 1/2" 6-kant gaande van 13 tot 24mm.

Kenmerken:

- Geleverd op een metalen rail met dopclips.
- L. 80mm.

Order nr.	101710101
Orig. nr.	M12086
Doppen 1/2" lang	mm 13 · 14 · 15 · 16 · 17 · 18 · 19 · 24
Prijs	€ 38,50

TENGTOOLS



Set van 9 korte doppen 1/2" TX-E gaande van E10 tot E24.

Kenmerken:

- Geleverd op een metalen rail met dopclips.

Order nr.	237670104	116610104
Orig. nr.	M1209AF	M1210
Doppen 1/2"	E	10 - 11 - 12 - 14 - 16 - 18 - 20 - 22 - 24
Doppen 1/2"	inch	3/16 - 7/32 - 1/4 - 9/32 - 5/16 - 3/8 - 1/2 - 9/16 - 5/8
Prijs	€ 30,50	30,90

TENGTOOLS



Set van 9 korte dopbitsen 1/2" Hex gaande van Hex 5 tot 17mm.

Kenmerken:

- Geleverd op een metalen rail met dopclips.

Order nr.	19070101
Orig. nr.	M1212
Dopbitsen 1/2"	mm 5 - 6 - 7 - 8 - 9 - 10 - 12 - 14 - 17
Prijs	€ 36,90

TENGTOOLS



Set van 6 lange dopbitsen 1/2" Hex gaande van Hex 5 tot 12mm.

Kenmerken:

- Geleverd op een metalen rail met dopclips.
- L.100mm.

Order nr.	118910108
Orig. nr.	M1211
Dopbitsen 1/2"	mm 5 - 6 - 7 - 8 - 10 - 12
Prijs	€ 33,50

TENGTOOLS



Set van 9 korte dopbitsen 1/2" TX (M1213TX) en TPX (M1213TPX) gaande TX20 tot TX60.

Kenmerken:

- Geleverd op een metalen rail met dopclips.

Order nr.	38190054	38190104
Orig. nr.	M1213TX	M1213TPX
Dopbitsen 1/2" TX	20 - 25 - 27 - 30 - 40 - 45 - 50 - 55 - 60	
Dopbitsen 1/2" TPX		20 - 25 - 27 - 30 - 40 - 45 - 50 - 55 - 60
Prijs	€ 36,90	36,90

TENGTOOLS



Set van 12 korte doppen 1/2" 6-kant gaande van 10 tot 24mm.

Kenmerken:

- Roestvrijstaal.
- Geleverd op een metalen rail met dopclips.

Order nr.	162550107
Orig. nr.	MS1213
Maat	mm 10 - 11 - 12 - 13 - 14 - 15 - 16 - 17 - 18 - 19 - 21 - 24
Verlengstuk	mm 75
Prijs	€ 249,00

SLEUTELS

Ons assortiment werd gedurende vele jaren ontwikkeld, met gebruik van DIN- en ISO-normen als minimum maatstaf voor kwaliteit- en maattoleranties. Een beleid dat vaak tot beste noteringen in consumenten- en vakbladen heeft geleid. Alle sleutels zijn beschikbaar zowel individueel als ook in complete sets opgeslagen in Teng Tools TC-trays, EVA-trays en/of in hoogwaardige stoffen opbergzakken of op wandrekken.

Steekringsleutels

- Ontworpen en vervaardigd conform DIN3113A, uit hoogwaardig chroom vanadium staal.
- 15° hellingshoek aan de ringkant om het werk te vergemakkelijken op platte oppervlakken.
- Speciale "hip grip" ringkant met hoge grip, om de kracht op de kant en niet op de hoek uit te oefenen. Dit voorkomt dat de bouten beschadigd worden, en maakt het gebruik op eerder beschadigde bouten mogelijk.

Ratel steekringsleutels

- Omkeerbare ratel met hellingshoek 15 graden aan de ringkant om het werk te vergemakkelijken op platte oppervlakken.
- Snel omschakelsysteem voor richtingsverandering met één hand.
- 72 tanden ratel met een increment van slechts 5 graden.

Ratel sleutels met flexibele kop

- 12-kant ratel steekringsleutel met 180 graden flexibele verbinding voor toegang in de meest moeilijk te bereiken plaatsen.
- 72 tanden ratel met een increment van slechts 5 graden.





TENGTTOOLS

TENGTTOOLS

TENGTTOOLS

TENGTTOOLS

Get organised™



Steekringsleutels

TENGOOLS



Steekringsleutel set.



Kenmerken:

- Chrome vanadium staal.
- Identieke maten aan beide uiteinde satijn afwerking.
- Hellingshoek ringkant 15°.

Geleverd in een kartonnen doos.

Order nr.	Orig. nr.	Aantal stuks	Steekringsleutels mm	Prijs €
185860103	6512N	12	8, 9, 10, 11, 12, 13, 14, 15, 16, 17, 18, 19	46,50
185830106	6512	12	8 - 9 - 10 - 11 - 12 - 13 - 14 - 15 - 16 - 17 - 19 - 22	49,50
185830304	6517	17	6 - 7 - 8 - 9 - 10 - 11 - 12 - 13 - 14 - 15 - 16 - 17 - 18 - 19 - 20 - 21 - 22	72,90
185830205	6521	21	6 - 7 - 8 - 9 - 10 - 11 - 12 - 13 - 14 - 15 - 16 - 17 - 18 - 19 - 20 - 21 - 22 - 24 - 27 - 30 - 32	114,00

TENGOOLS



3 sets van steekringsleutels. Alle sets hebben opeenvolgend maten en kunnen gecombineerd worden.

Kenmerken:

- Identieke maten aan beide uiteinden.
- Chrome vanadium.
- Satijn afwerking.
- Hellingshoek ringkant 15°.

Geleverd op een handige muurhanger.

Order nr.	154910103	154910202	154910301
Orig. nr.	6515MMA	6512MMA	6507JMMMA
Aantal stuks	15	12	7
Steekringsleutels mm	5,5 - 6 - 7 - 8 - 9 - 10 - 11 - 12 - 13 - 14 - 15 - 16 - 17 - 19	20 - 21 - 22 - 23 - 24 - 25 - 26 - 27 - 28 - 29 - 30 - 32	33 - 34 - 36 - 38 - 41 - 46 - 50
Prijs €	60,50	121,00	227,00

TENGOOLS



Set van 12 steekringsleutels gaande van 8 tot 19mm.

Kenmerken:

- De ringkant heeft een hellingshoek van 15°.
- Identieke maten aan beide kanten van de sleutel.
- Geleverd met een wandrek voor montage op een muur of wandpaneel.

Order nr.	128240108
Orig. nr.	WRS12
Sleutels mm	8 - 9 - 10 - 11 - 12 - 13 - 14 - 15 - 16 - 17 - 18 - 19
Prijs €	49,50

IZELTAS



AF / INCH

Set steekringsleutels gaande van ofwel 1/4" tot 1 3/16", ofwel 1/4" tot 1 5/16" naargelang de set. Geleverd in een kartonnen doos.

Order nr.	703311117	703311120
Orig. nr.	IZ0331441117	IZ0331441120
Aantal stuks	17	20
Steekringsleutels mm	1/4 - 5/16 - 3/8 - 7/16 - 1/2 - 9/16 - 19/32 - 5/8 - 11/16 - 3/4 - 25/32 - 13/16 - 7/8 - 15/16 - 1 - 1 1/16 - 1 3/16	1/4 - 5/16 - 3/8 - 7/16 - 1/2 - 9/16 - 19/32 - 5/8 - 11/16 - 3/4 - 25/32 - 13/16 - 7/8 - 15/16 - 1 - 1 1/16 - 1 1/8 - 1 3/16 - 1 1/4 - 1 5/16
Prijs €	133,00	172,00

TENGOOLS

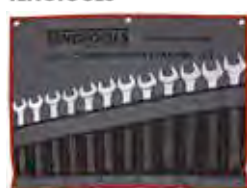

Steekringsleutelsets.

Kenmerken:

- Chrome vanadium.
- Identieke maten aan beide uiteinden.
- Satijn afwerking.
- Hellingshoek ringkant 15°.

Geleverd in een roltas.

Order nr.	Orig. nr.	Aantal stuks	Steekringsleutels mm	Steekringsleutels inch	Prijs €
151590304	6515MM	15	5,5 - 6 - 7 - 8 - 9 - 10 - 11 - 12 - 13 - 14 - 15 - 16 - 17 - 18 - 19 - 6 - 7 - 8 - 9 - 10 - 11		61,50
167170109	6517MM	17	12 - 13 - 14 - 15 - 16 - 17 - 18 - 19 - 20 - 21 - 22		74,90
151590205	6512MM	12	20 - 21 - 22 - 23 - 24 - 25 - 26 - 27 - 28 - 29 - 30 - 32		123,00
151590106	6507JMM	7	33 - 34 - 36 - 38 - 41 - 46 - 50		213,00
167180108	6526MM	26	6 - 7 - 8 - 9 - 10 - 11 - 12 - 13 - 14 - 15 - 16 - 17 - 18 - 19 - 20 - 21 - 22 - 23 - 24 - 25 - 26 - 27 - 28 - 29 - 30 - 32		175,00
151590403	6507AF	7		13/16 - 7/8 - 15/16 - 1 - 1 1/16 - 1 1/8 - 1 1/4	71,50
151590601	6509AF	9		1/4 - 5/16 - 3/8 - 7/16 - 1/2 - 9/16 - 5/8 - 11/16 - 3/4 - 15/16 - 1 3/8 - 1	40,50
151590502	6507JAF	7		7/16 - 1 1/2 - 1 1/8 - 1 3/4 - 1 7/8	229,00

TENGOOLS



Set van 12 steekringsleutels gaande van 8 tot 19mm. TC-tray.

Order nr.	27560101		
Orig. nr.	TT1236		
Aantal stuks	12		
Steekringsleutels	mm	8-9-10-11-12-14-14-15-16-17-18-19	
Afmetingen (l x b x h)	mm	265 x 142 x 50	
Prijs	€	44,50	

TENGOOLS



AF / INCH

Set van 8 steekringsleutels AF gaande van 5/16" tot 3/4".

Kenmerken:

- De ringkant heeft een hellingshoek van 15°.
- Identieke maten aan beide kanten van de sleutel.
- TC-tray.

Order nr.	58050303		
Orig. nr.	TT3592		
Aantal stuks	8		
Steekringsleutels		5/16 - 3/8 - 7/16 - 1/2 - 9/16 - 5/8 - 11/16 - 3/4	
Afmetingen (l x b x h)	mm	265 x 142 x 50	
Prijs	€	38,50	

TENGOOLS



AF / INCH

Set van 7 steekringsleutels gaande van 20 tot 32mm.

Kenmerken:

- De ringkant heeft een hellingshoek van 15°.
- Identieke maten aan beide kanten van de sleutel.
- TTX-tray.

Order nr.	68910108		
Orig. nr.	TTX2032		
Aantal stuks	7		
Maat	mm	20 - 21 - 22 - 24 - 27 - 30 - 32	
Afmetingen (l x b x h)	mm	560 x 110 x 40	
Prijs	€	73,50	

TENGOOLS



AF / INCH

Steekringsleutel.

Kenmerken:

- Uitvoering DIN 3113A - ISO 3319.
- Vorm ISO 7738.
- Teng Tools chroom vanadium staal.
- Matverchromd.
- Identieke maten aan beide uiteinden.
- Hellingshoek ringkant 15°.
- Teng Tools (600...) of Izeltas (IZ...).

Order nr.	Orig. nr.	Maat mm	Maat inch	Lengte mm	Prijs €	
72670052		6005055	5,5	95	4,40	
72670102		600506	6	100	4,00	
72670201		600507	7	110	4,00	
72670300		600508	8	120	4,00	
72670409		600509	9	130	4,30	
72670508		600510	10	140	4,40	
72670607		600511	11	150	4,60	
72670706		600512	12	160	5,10	
72670805		600513	13	170	5,20	
72670904		600514	14	180	5,40	
72671001		600515	15	190	5,60	
72671100		600516	16	200	6,20	
72671209		600517	17	210	6,70	
72671308		600518	18	220	7,80	
72671407		600519	19	230	8,00	
72671506		600520	20	240	8,70	
72671605		600521	21	250	8,80	
72671704		600522	22	260	10,50	
72671803		600523	23	270	11,90	
72671902		600524	24	280	11,90	
72672009		600525	25	290	13,90	
72672108		600526	26	300	14,50	
72672207		600527	27	310	15,90	
72672306		600528	28	320	16,50	
72672405		600529	29	330	16,50	
72672504		600530	30	340	18,90	
72672603		600532	32	360	19,90	
72672652		600533	33	380	26,50	
72672686		600534	34	380	26,50	
72672702		600536	36	410	36,90	
72672751		600538	38	430	40,50	
72672801		600541	41	460	47,50	
72672850		600546	46	500	60,50	
72672900		600550	50	540	74,50	
72672926		600555	55	560	193,00	
72672942		600558	58	600	242,00	
72672959		600560	60	600	245,00	
72672967		600565	65	680	343,00	
72672983		600570	70	680	349,00	
72673007		600108		1/4	100	4,30
72673106		600110		5/16	120	4,30
72673205		600112		3/8	140	4,50
72673304		600114		7/16	150	4,70
72673403		600116		1/2	170	5,30
72673502		600118		9/16	180	5,60
72673601		600120		5/8	200	6,30
72673700		600122		11/16	210	6,60
72673809		600124		3/4	230	8,30
72673825		600126		13/16	250	9,40
72673833		600128		7/8	260	10,90
72673841		600130		15/16	280	12,90
72673858		600132		1	290	14,90
72673874		600136		1 1/8	330	18,50
72673866		600134		1 1/16	310	16,90
72673882		600140		1 1/4	360	21,50
72673908		600142		1 5/16	380	26,50
72674005		600144		1 3/8	380	26,90
72674104		600146		1 7/16	410	36,90
72674203		600148		1 1/2	430	36,90
72674302		600152		1 5/8	460	47,90
72674401		600156		1 3/4	500	63,90
72674500		600160		1 7/8	540	85,90

TOOLS

TENGOOLS



Handige stalen ring met clip-opening voor bevestiging van uw steekringsleutels op een ringhanger.

Order nr.	27560200		
Orig. nr.	600		
Prijs	€	2,80	

TENGOOLS



Set van 10 stubby (korte) steekringsleutels gaande van 10 tot 19mm.

Kenmerken:

- De ringkant heeft een hellingshoek van 15°.
- TC-tray.

Order nr.	109470104			
Orig. nr.	TT6010M			
Aantal stuks	10			
Steekringsleutels	mm	10 - 11 - 12 - 13 - 14 - 15 - 16 - 17 - 18 - 19		
Afmetingen (l x b x h)	mm	256 x 142 x 50		
Prijs	€	45,50		

TENGOOLS



Stubby steekringsleutel.

Kenmerken:

- Extra-korte uitvoering.
- Teng Tools chroom vanadium staal.
- Matverchromd.
- De ringkant heeft een hellingshoek van 15°.
- Identieke maten aan beide uiteinden.

Order nr.	Orig. nr.	Maat mm	Lengte mm	Prijs €
116510108	6005M10	10	95	3,80
116510207	6005M11	11	100	4,10
116510306	6005M12	12	105	4,50
116510405	6005M13	13	110	4,70
116510504	6005M14	14	115	4,90
116510603	6005M15	15	120	5,30
116510702	6005M16	16	125	5,70
116510801	6005M17	17	130	6,40
116510900	6005M18	18	135	6,70
116511007	6005M19	19	140	7,50

TENGOOLS



Set van 8/10 ratel-steekringsleutels gaande van 8 tot 19mm/10 tot 19mm.

Kenmerken:

- Vervaardigd uit hoogwaardig Teng Tools chroom vanadium staal.
- Matverchromd.
- Identieke maten aan beide uiteinden.
- Ringkant 12-kant met hellingshoek 15°
- Handige omschakelknop voor het wijzigen van de draairichting.
- Aktiehoek 5°.

Geleverd in een roltas.

Order nr.	167150101	186430104
Orig. nr.	6508RMM	6510RMM
Aantal stuks	8	10
Maatsysteem	mm	mm
Ratel-steekringsleutels	mm	8 - 10 - 11 - 12 - 13 - 14 - 17 - 19
		10, 11, 12, 13, 14, 15, 16, 17, 18, 19
Prijs	€	121,00
		156,00

TENGOOLS



Set van 8 ratel-steekringsleutels gaande van 8 tot 19mm.

Kenmerken:

- Identieke maten aan beide kanten van de sleutel.
- Model zonder omschakelknop.
- Platte sleutel.

Geleverd in een roltas.

Order nr.	167160100	
Orig. nr.	6508RSMM	
Aantal stuks	8	
Maatsysteem	mm	
Ratel-steekringsleutels	mm	8 - 10 - 11 - 12 - 13 - 14 - 17 - 19
Prijs	€	107,00

TENGOOLS



Set van 9 extra-lange steekringsleutels gaande van 8 tot 19mm.

Kenmerken:

- De ringkant heeft een hellingshoek van 15°.

Geleverd in een kunststof rotas.

Order nr.	116520107		
Orig. nr.	6059LMP		
Aantal stuks	9		
Maat	mm	8 · 10 · 11 · 12 · 13 · 14 · 15 · 17 · 19	
Prijs	€	39,50	

TENGOOLS



Set van 8 ratel-steekringsleutels gaande van 8 tot 19mm. TC-Tray.

Kenmerken:

- Identieke maten aan beide kanten van de sleutel.
- Ringkant 12-kant met hellingshoek 15°
- Handige omschakelknop voor het wijzigen van de draairichting.
- Aktiehoek 5°.

Order nr.	109730101		
Orig. nr.	TT6508R		
Aantal stuks	8		
Sleutels	mm	8 · 10 · 11 · 12 · 13 · 14 · 17 · 19	
Afmetingen (l x b x h)	mm	265 x 142 x 50	
Prijs	€	123,00	

TENGOOLS



11-delige ratel-steekringsleutel set.

Kenmerken:

- Vervaardigd uit hoogwaardig chroom vanadium staal.
- Matverchromd.
- Identieke maten aan beide uiteinden.
- Ringkant 12-kant met hellingshoek 15° en handige omschakelknop voor het wijzigen van de draairichting.
- Actiehoek 5°.

Order nr.	186740106		
Orig. nr.	TT6511R		
Aantal stuks	11		
Maten	mm	8, 9, 10, 11, 12, 13, 14, 15, 16, 17, 19	
Prijs	€	157,00	

TENGOOLS



Set van 8 ratel-steekringsleutels gaande van 8 tot 19mm. TC-tray.

Kenmerken:

- Identieke maten aan beide kanten van de sleutel.
- Model zonder omschakelknop.
- Platte sleutel.

Order nr.	166720102		
Orig. nr.	TT6508RS		
Aantal stuks	8		
Sleutels	mm	8 · 10 · 11 · 12 · 13 · 14 · 17 · 19	
Afmetingen (l x b x h)	mm	265 x 142 x 50	
Prijs	€	98,50	

TENGOOLS



Set van 11 ratel-steekringsleutels gaande van 8 tot 19mm. TC-tray.

Kenmerken:

- Identieke maten aan beide kanten van de sleutel.
- Model zonder omschakelknop.
- Platte sleutel.

Order nr.	186750105		
Orig. nr.	TT6511RS		
Aantal stuks	11		
Maten	mm	8, 9, 10, 11, 12, 13, 14, 15, 16, 17, 19	
Prijs	€	140,00	

TENGOOLS



Set van 8 swivel-ratel-steekringsleutels gaande van 8 tot 19mm. TC-tray.

Kenmerken:

- Swivel-zijde is 180° klinkbaar.
- Identieke maten aan beide kanten van de sleutel.

Order nr.	131900102		
Orig. nr.	TT6508RF		
Aantal stuks	8		
Ratel-steekringsleutels	8 · 10 · 11 · 12 · 13 · 14 · 17 · 19		
Afmetingen (l x b x h)	mm	265 x 142 x 50	
Prijs	€	115,00	

TENGOOLS



AF / INCH

Set van 8 ratel-steekringsleutels gaande van 5/16" tot 3/4". TC-Tray.

Kenmerken:

- Identieke maten aan beide kanten van de sleutel.
- Ringkant 12-kant met hellingshoek 15°
- Handige omschakelknop voor het wijzigen van de draairichting.
- Aktiehoek 5°.

Order nr.	109730200
Orig. nr.	TT6508RAF
Aantal stuks	8
Ratel-steekringsleutels	5/16" · 3/8" · 7/16" · 1/2" · 9/16" · 5/8" · 11/16" · 3/4"
Maatsysteem	inch
Prijs	€ 130,00

TENGOOLS



Set van 12 lange steekringsleutels met dezelfde maat aan beide uiteinden.

Kenmerken:

- Ringkant 12-kant met hellingshoek 15°.
- Geleverd in een TTX-tray die geschikt is voor de Teng Tools koffers en gereedschapswagens.

Order nr.	185870102
Orig. nr.	TTXLMP12
Aantal stuks	12
Maten	mm 8 · 9 · 10 · 11 · 12 · 13 · 14 · 15 · 16 · 17 · 18 · 19
Prijs	€ 59,50

TENGOOLS



Steekringsleutels extra-lange uitvoering.

Kenmerken:

- Teng Tools chroom vanadium staal.
- Verchroomd en gepolijst.
- Identieke maten aan beide uiteinden.
- Hellingshoek ringkant 15°.

Order nr.	Orig. nr.	Maat mm	Maat inch	Lengte mm	Prijs €
116490103		605908	8	148	4,80
116490202		605909	9	158	4,80
116490301		605910	10	168	4,20
116490400		605911	11	188	5,00
116490509		605912	12	198	5,10
116490608		605913	13	208	5,30
116490707		605914	14	228	7,30
116490806		605915	15	238	8,00
116490905		605916	16	246	8,20
116491002		605917	17	266	9,20
116491101		605918	18	276	9,70
116491200		605919	19	285	10,50
116500901		601924		268	8,00
116500703		601920	3/4 5/8	208	6,00

TENGOOLS



Ratel-steekringsleutel.

Kenmerken:

- Vervaardigd uit hoogwaardig chroom vanadium staal.
- Matverchroomd.
- Identieke maten aan beide uiteinden.
- Ringkant 12-kant met hellingshoek 15°.
- Handige omschakelknop voor het wijzigen van de draairichting.
- Aktiehoek 5°.

Order nr.	Orig. nr.	Maat mm	Maat inch	Lengte mm	Prijs €
109720102		600508R	8	140	14,90
109720201		600509R	9	150	14,90
109720300		600510R	10	159	15,70
109720409		600511R	11	165	16,60
109720508		600512R	12	172	17,80
109720607		600513R	13	178	19,10
109720706		600514R	14	191	19,50
109720805		600515R	15	200	20,80
109720904		600516R	16	208	22,00
109721001		600517R	17	226	22,50
109721100		600518R	18	237	23,70
109721209		600519R	19	248	24,60
109721308		600522R	22	290	33,60
109721407		600524R	24	323	40,70
109721506		600527R	27	359	71,80
109721605		600530R	30	403	85,00
109721704		600532R	32	425	99,50
109722009		600110R		140	14,40
109722108		600112R	5/16 3/8	159	15,70
109722207		600114R	7/16	165	16,60
109722306		600116R	1/2	178	18,60
109722405		600118R	9/16	191	19,50
109722504		600120R	5/8	208	22,00
109722603		600122R	11/16	226	22,00
109722702		600124R	3/4	248	24,20
109722801		600126R	13/16	290	33,10
109722900		600128R	7/8	323	33,10

TENGOOLS



Ratel-steekringsleutel.

Kenmerken:

- Plat.
- Model in CRV.
- Identieke maten aan beide uiteinden.

Order nr.	Orig. nr.	Maat mm	Lengte mm	Prijs €
162680102	600508RS	8	111	13,50
162680201	600509RS	9	123	13,50
162680300	600510RS	10	131	14,00
162680409	600511RS	11	147	14,40
162680508	600512RS	12	155	14,90
162680607	600513RS	13	164	15,20
162680706	600514RS	14	182	17,80
162680805	600515RS	15	192	18,60
162680904	600516RS	16	202	20,30
162681001	600517RS	17	223	21,70
162681100	600518RS	18	234	22,90
162681209	600519RS	19	246	23,70

TENGOOLS



Ratel-steekringsleutel.

Kenmerken:

- Met 180° klinkbare ratelkant.
- Vervaardigd uit hoogwaardig Teng Tools chroom vanadium staal.
- Matverchromd.
- Identieke maten aan beide uiteinden.
- Ringkant 12-kant wijzigen de draairichting door het omdraaien van de sleutel.
- Aktiehoek 5°.
- Steeksleutel met hellingshoek 15°.

Order nr.	Orig. nr.	Maat mm	Lengte mm	Prijs €
131890105	600508RF	8	127	15,70
131890204	600509RF	9	131	15,70
131890303	600510RF	10	136	16,10
131890402	600511RF	11	141	16,90
131890501	600512RF	12	147	17,80
131890600	600513RF	13	154	18,60
131890709	600514RF	14	160	19,50
131890808	600515RF	15	169	18,60
131890907	600516RF	16	179	19,50
131891004	600517RF	17	190	21,20
131891103	600518RF	18	203	22,50
131891202	600519RF	19	215	22,90

TENGOOLS

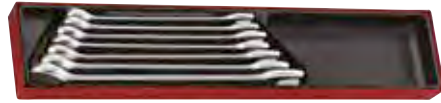

Set van 7 steekringsleutels gaande van 13/15" tot 1 1/4".

Kenmerken:

- De ringkant heeft een hellingshoek van 15°.
- Identieke maten aan beide kanten van de sleutel.
- TTX-tray.

Order nr.	68910207	
Orig. nr.	TTX2640	
Aantal stuks	7	
Maat	inch	13/16 - 7/8 - 15/16 - 1 - 1 1/16 - 1 1/8 - 1 1/4
Afmetingen (l x b x h)	mm	560 x 110 x 40
Prijs	€	77,90

TENGOOLS



12-delige ratelsteekringsleutelset op muurrek.

Kenmerken:

- Rech model, draai de sleutel om de richting van de ratel te veranderen
- Zelfde maat op beide uiteinden
- Geleverd met handige rek met markering voor elke sleutel, voor bevestiging aan een perfopaneel of wand

Order nr.	199820101	
Orig. nr.	WRSP12RS	
Aantal stuks	12	
Maat	mm	8 - 9 - 10 - 11 - 12 - 13 - 14 - 15 - 16 - 17 - 18 - 19
Prijs	€	139,00

TENGOOLS



12-delige extra lange steekringsleutelset op muurrek.

Kenmerken:

- Zelfde maat op beide vieden
- Geleverd met handige rek met markering voor elke sleutel, voor bevestiging aan een perfopaneel of wand

Order nr.	199830100	
Orig. nr.	WRSP12LMP	
Aantal stuks	12	
Maat	mm	8 - 9 - 10 - 11 - 12 - 13 - 14 - 15 - 16 - 17 - 18 - 19
Prijs	€	57,90

Ringsleutels

TENGOOLS



Ringsleutel set.

Kenmerken:

- Uitvoering DIN 838.
- 12-kant ringkant.
- Dubbele gebogen 15° hoek.
- Chroom vanadium staal.
- Matverchroomd.

Geleverd in een kartonnen doos.

Order nr.	185820107	185820206
Orig. nr.	6308	6311
Ringsleutels	6x7 · 8x9 · 10x11 · 12x13 - 14x15 · 16x17 · 18x19 - 20x22	6x7 · 8x9 · 10x11 · 12x13 - 14x15 · 16x17 · 18x19 - 20x22 · 21x23 · 24x27 - 30x32
Aantal stuks	8	11
Prijs	€ 49,90	€ 85,90

IZELTAS



Set ringsleutels. Gaande van ofwel 1/4" tot 1", ofwel 1/4" tot 1 5/16" naargelang de set. Geleverd in een karton doos.

Order nr.	704312108	704312112
Orig. nr.	I20431442108	I20431442112
Aantal stuks	8	12
Ringsleutels	1/4x5/16 · 5/16x3/8 - 7/16x1/2 · 9/16x5/8 · 19/32x11/16 · 3/4x25/32 - 1 3/16x7/8 · 1 5/16x1	1/4x5/16 · 5/16x3/8 - 3/8x7/16 · 7/16x1/2 · 9/16x5/8 · 19/32x11/16 - 3/4x25/32 · 13/16x7/8 - 15/16x1 · 1 1/16x1 1/4 · 1 1/8x1 5/16 · 1 3/16x1 5/16
Prijs	€ 67,90	€ 134,00

TENGOOLS



Set van 8 dubbele ringsleutels gaande van 6 tot 22mm. Geleverd in een rolltas.

Order nr.	151640109
Orig. nr.	6308MM
Ringsleutels	mm 6x7 · 8x9 · 10x11 · 12x13 · 14x15 · 16x17 · 18x19 · 20x22
Aantal stuks	8
Prijs	€ 52,50

TENGOOLS



Set van 5 platte extra lange dubbele ringsleutels, van 8 tot 24 mm.

Kenmerken:

- Verschillende maten aan beide uiteinden.
- Satijn afwerking.

Geleverd op een muurrek.

Order nr.	186220109
Orig. nr.	WRFLS05
Maten	mm 8x10 · 11x13 · 12x14 · 17x19 · 22x24
Prijs	€ 119,00

TENGOOLS



Set van 11 dubbele ringsleutels gaande van 6 tot 32mm. TTX-tray.

Order nr.	68910157
Orig. nr.	TTX6311
Aantal stuks	11
Ringsleutels	mm 6x7 · 8x9 · 10x11 · 12x13 · 14x15 · 16x17 - 18x19 · 20x22 · 21x23 · 24x27 · 30x32
Afmetingen (l x b x h)	mm 560 x 110 x 40
Prijs	€ 91,50

TENGOOLS



Compacte dubbele ringsleutel.

Kenmerken:

- Model Rigger Jigger.
- Maat 10x13mm.
- Lengte 120mm.
- Teng Tools chroom vanadium staal.
- Matverchroomd.

Order nr.	101660108
Orig. nr.	601013
Prijs	€ 6,50

TENGOOLS

AF / INCH



Dubbele ringsleutel.

Kenmerken:

- Uitvoering DIN 838.
- 12-kant ringkanten.
- Dubbele gebogen 15° hoek.
- Chroom vanadium staal.
- Matverchromd.
- Verschillende maten aan beide uiteinden.

Order nr.	Orig. nr.	Maat mm	Lengte mm	Prijs €
111960100	630607	6x7	168	5,80
111960209	630809	8x9	183	6,30
111960308	631011	10x11	198	7,20
111960407	631213	12x13	217	7,30
111960506	631415	14x15	239	8,20
111960605	631617	16x17	260	8,50
111960704	631819	18x19	292	10,50
111960803	632022	20x22	318	12,50
111960902	632123	21x23	326	13,90
111961009	632427	24x27	329	16,50
111961108	633032	30x32	362	19,90

IZELTAS

AF / INCH



Halve maansleutels. (Startersleutels).

Kenmerken:

- Chroom vanadium staal.
- Matverchromd.
- Verschillende maten aan beide uiteinden.
- De ringkant heeft een hoekstand van 15°.

Order nr.	Orig. nr.	Maat mm	Lengte mm	Maat inch	Prijs €
705301113	I20530441113	11x13	150		21,50
705301315	I20530441315	13x15	185		25,50
705301317	I20530441317	13x17	185		25,50
705301417	I20530441417	14x17	185		28,50
705301517	I20530441517	15x17	185		28,50
705301922	I20530441922	19x22	230		32,50
705311112	I20531441112		150	7/16x1/2	28,50
705311416	I20531441416		185	9/16x5/8	34,90

TENGOOLS



Kenmerken:

- Platte, dubbele ringsleutel.
- Satijn afwerking.
- **Verschillende maten aan beide uiteinden.**

Order nr.	Orig. nr.	Maat mm	Lengte mm	Prijs €
151610102	630810FL	8x10	265	18,50
151610151	631113FL	12x14	328	23,50
151610201	631214FL	12x14	328	23,50
151610300	631719FL	17x19	407	29,90
151610409	632224FL	22x24	430	38,90
151610250	631618FL	16x18	408	29,90

IZELTAS



Dubbele ringsleutel.

Kenmerken:

- Uitvoering DIN 838.
- 12-kant ringkanten.
- Dubbele gebogen 15° hoek.
- Chroom vanadium staal.
- Matverchromd.
- Verschillende maten aan beide uiteinden.

Order nr.	Orig. nr.	Maat mm	Lengte mm	Maat inch	Prijs €
704302528	I20430442528	25x28	350,5		23,50
704303236	I20430443236	32x36	401		28,50
704303641	I20430443641	36x41	438,5		51,50
704304146	I20430444146	41x46	486		70,90
704304650	I20430444650	46x50	536		97,50
704316080	I20431440608		176	1/4x5/16	6,90
704319011	I20431440911		206	3/8x7/16	7,60
704311112	I20431441112		220,5	7/16x1/2	8,10
704311214	I20431441214		220,5	1/2x9/16	8,80
704311415	I20431441415		236	9/16x19/32	10,50
704311416	I20431441416		236	9/16x5/8	10,90
704311517	I20431441517		250,5	19/32x11/16	11,90
704311920	I20431441920		271	3/4x25/32	13,90
704312122	I20431442122		310,5	13/16x7/8	16,90
704312325	I20431442325		331	15/16x1	25,50
704312631	I20431442631		371	1 1/6x1 1/4	29,50
704312833	I20431442833		371	1 1/8x1 5/16	31,50
704313033	I20431443033		371	1 3/16x1 5/16	31,50

TENGOOLS



7-delige open pijpringsleutelset.

Kenmerken:

- Speciaal ontworpen om pijp- en slangkoppelingen te openen en aan te spannen.
- Ideaal voor beperkte ruimtes zoals hydraulische toepassingen.
- De ring ratel is eenvoudig te openen.
- 12-kant.

Order nr.	186780102				
Orig. nr.	TTXQRS07				
Maat	mm	13	14	16	22 24 27 32
Prijs	€	214,00			

TOOLS

TENGOOLS



Open pijpringsleutel. Speciaal ontworpen voor het los- en vastdraaien van pijp- en slangkoppelingen. Perfect voor kleine ruimtes zoals hydraulische inrichtingen. De ratel gaat eenvoudig en ingenieus open voor een gemakkelijke toegang tot de moer in de koppeling. 12-kant.

Order nr.	Orig. nr.	Maat mm	L mm	D mm	H1 mm	H2 mm	Prijs €
186790101	600813	13	141	27,5	7,2	8	25,50
186790200	600814	14	191	35,7	10	9	30,90
186790309	600816	16	191	35,7	10	9	30,90
186790317	600817	17	191	35,7	10	9	30,90
186790325	600819	19	191	35,7	10	9	31,90
186790408	600822	22	233	40,7	13	12	37,90
186790507	600824	24	235	43,2	13	12	43,50
186790606	600827	27	325	54,2	14,1	14,4	58,90
186790655	600830	30	325	56,4	15,9	14,4	58,90
186790705	600832	32	325	58,5	15,9	14,4	63,50

TENGOOLS



Dubbele ratel-ringsleutels.

Kenmerken:

- RORS-model.
- Teng Tools chroom vanadium staal.
- Matverchroomd.
- Verschillende maten aan beide uiteinden.
- Met hendel voor wijziging van draairichting.
- De ringkant heeft een hoekstand van 25°.

Order nr.	Orig. nr.	Maat mm	Lengte mm	Ringkant hoogte mm	Prijs €
116710104	680608	6x8	112	8	7,10
116710203	680709	7x9	133	8,4	8,90
116710302	681013	10x13	163	10,2	11,50
116710401	681214	12x14	172	10,2	11,50
116710500	681719	17x19	203	11	13,50
116710609	682122	21x22	235	11,4	14,40

TENGOOLS



Dubbele open-ringsleutels.

Kenmerken:

- Teng Tools chroom vanadium staal.
- Matverchroomd.
- Verschillende maten aan beide uiteinden.

Order nr.	Orig. nr.	Maat mm	Lengte mm	Maat inch	Hoogte mm	Prijs €
105840102	641011	10x11	152,4		7,9	5,40
105840201	641213	12x13	178,6		10,0	6,10
105840227	641314	13x14	178,6		10,0	7,90
105840243	641617	16x17	196,0		11,6	9,20
105840268	641922	19x22	207,7		13,8	10,90
105840300	661416		158,8	7/16 x 1/2	11,9	6,50

TENGOOLS

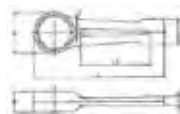

Slagringsleutels.

Kenmerken:

- Chroom vanadium staal.
- Zwart verchroomd.

Order nr.	Orig. nr.	Maat mm	Lengte mm	Prijs €
160750105	903024	24	162	18,90
160750303	903030	30	190	24,00
160750402	903032	32	190	26,20
160750501	903036	36	205	29,70
160750600	903038	38	229	35,00
160750709	903041	41	240	36,60
160750808	903046	46	240	47,60
160750907	903050	50	255	50,30
160751004	903055	55	266	58,30
160751103	903060	60	280	65,90
160751202	903065	65	298	80,10
160751301	903070	70	330	109,40
160751400	903075	75	330	111,00
160751509	903080	80	335	237,20
160751608	903085	85	355	275,00
160751707	903090	90	395	338,10
160751806	903095	95	395	364,40
160751905	903100	100	420	427,50

TENGOOLS



Set van 6 dubbele ratel-ringsleutels 12-kant gaande van 6 tot 22mm. TC-tray.

Order nr.	116700105
Orig. nr.	TTRORS
Aantal stuks	6
Ringsleutels	6x8 · 7x9 · 10x13 · 12x14 · 17x19 · 21x22
Afmetingen (l x b x h)	mm 265 x 142 x 50
Prijs	€ 47,90

TENGOOLS

NEW



Dubbele ratelsleutel met verschillende 12-kant maten aan elk einde.

Kenmerken:

- Chrome vanadium.
- Omkeerbare actie.
- Satijn afwerking.

Order nr.	231410309	231410101	231410200
Orig. nr.	60050811RX	60051215RX	60051619RX
Omschrijving	mm 8x9 · 10x11	12x13 · 14x15	16x17 · 18x19
L	mm 150	190	230
D1	mm 19,2	25,5	31,7
D2	mm 22	28	34
H	mm 13,5	18,4	20,8
Prijs	€ 25,10	27,60	31,90

TENGOOLS

Set van 3 dubbele ratelsleutels met verschillende 12-kant maten aan elk einde.

Kenmerken:

- Omkeerbare actie
- Chroom vanadium
- Satijn afwerking

Bevat:

- 60050811RX
- 60051215RX
- 60051619RX



NEW

Geleverd in een handig etui voor bevestiging aan een riem

Order nr.	231411000		
Orig. nr.	6503RX		
Omschrijving	mm	8x9+10x11, 12x13+14x15, 16x17+18x19	
Prijs	€	65,90	

Steeksleutels

TENGOOLS



Set Steeksleutel gaande van ofwel 6mm tot 22mm, ofwel 6mm tot 32mm naargelang de set.

Kenmerken:

- DIN3110.
- Chroom vanadium staal.

Geleverd in een kartonnen doos.

Order nr.	185810108		185810207	
Orig. nr.	6208		6211	
Aantal stuks	8		11	
Steeksleutels	mm	6x7 - 8x9 - 10x11 - 12x13 - 14x15 - 16x17 - 18x19 - 20x22	6x7 - 8x9 - 10x11 - 12x13 - 14x15 - 16x17 - 18x19 - 20x22 - 21x23 - 24x27 - 30x32	
Prijs	€	28,90		54,50

IZELTAS



AF / INCH

Set steeksleutels gaande van ofwel 1/4" tot 1", ofwel 1/4" tot 1 5/16" naargelang de set. Geleverd in een kartonnen doos.

Order nr.	701611150		701611170	
Orig. nr.	IZ0161442108		IZ0161442112	
Aantal stuks	8		12	
Steeksleutels	inch	1/4x5/16 - 5/16x3/8 - 7/16x1/2 - 9/16x5/8 - 19/32x11/16 - 3/4x25/32 - 13/16x7/8 - 15/16x1	1/4x5/16 - 5/16x3/8 - 3/8x7/16 - 7/16x1/2 - 1/2x9/16 - 9/16x5/8 - 19/32x11/16 - 3/4x25/32 - 13/16x7/8 - 15/16x1 - 1 1/8x1 5/16	
Prijs	€	34,90		61,90

TENGOOLS



Set van 11 steeksleutels gaande van 6 tot 32mm.

Kenmerken:

- Chroom vanadium staal.
- DIN3110/ISO 3318.

Geleverd in kunststof rolltas.

Order nr.	151650108		
Orig. nr.	6211MM		
Aantal stuks	11		
Steeksleutels	mm	6x7 - 8x9 - 10x11 - 12x13 - 14x15 - 16x17 - 18x19 - 20x22 - 21x23 - 24x27 - 30x32	
Prijs	€	76,90	

TENGOOLS



Set van 8 dubbele steeksleutels gaande van 6 tot 22mm.

Kenmerken:

- Chroom vanadium staal.
- TC-tray.

Order nr.	03900107		
Orig. nr.	TT6208		
Steeksleutels	mm	6x7 - 8x9 - 10x11 - 12x13 - 14x15 - 16x17 - 18x19 - 20x22	
Afmetingen (l x b x h)	mm	265 x 142 x 50	
Prijs	€	30,90	

TENGOOLS



Steeksleutels.

Kenmerken:

- Uitvoering DIN 3110-ISO 3318.
- Chroom vanadium staal.
- Matverchroomd.
- Verschillende maten aan beide uiteinden.
- Hellingshoek 15°.

Order nr.	Orig. nr.	Maat mm	Lengte mm	Prijs €
101700102	620607	6x7	123	3,30
101700201	620809	8x9	140	3,30
101700300	621011	10x11	156	4,10
101700409	621213	12x13	172	5,00
101700508	621415	14x15	189	5,50
101700607	621617	16x17	204	6,10
101700706	621819	18x19	221	6,80
101700805	622022	20x22	237	8,60
101700904	622123	21x23	247	9,70
101701001	622427	24x27	263	12,50
101701100	623032	30x32	298	16,50



Steeksleutels.

Kenmerken:

- Uitvoering DIN 3110 -ISO 3318.
- Chroom vanadium staal.
- Matverchromd.
- Verschillende maten aan beide uiteinden.
- Hellingshoek 15°.

Order nr.	Orig. nr.	Maat mm	Lengte mm	Prijs €
701303641	I20130443641	36x41	360	33,90
701304146	I20130444146	41x46	400	57,90
701304650	I20130444650	46x50	450	64,50



Steeksleutel.

Kenmerken:

- Uitvoering DIN 3110 -ISO 3318.
- Chroom vanadium staal.
- Matverchromd.
- Verschillende maten aan beide uiteinden.
- Hellingshoek sleutel 15°.

Eenheid van verpakking: 10 stuks t.e.m. 18x19mm en 11/8"x15/16"; 5 stuks vanaf 19x21mm.

Order nr.	Orig. nr.	Lengte mm	Maat inch	Prijs €
701611020	I20161440809	107,5	5/16x 3/8	3,50
701611030	I20161440811	121	5/16 x 7/16	3,70
701611040	I20161440911	121	3/8x 7/16	3,60
701611050	I20161441112	135	7/16 x 1/2	4,00
701611060	I20161441214	148	1/2x 9/16	4,80
701611070	I20161441416	156	9/16 x 5/8	5,60
701611080	I20161441417	168	9/16 x 11/16	5,20
701611090	I20161441517	168	19/32 x 11/16	6,40
701611100	I20161441619	168	5/8 x 3/4	7,10
701611110	I20161441920	185	3/4 x 25/32	8,30
701611120	I20161441921	185	3/4 x 7/8	9,60
701611130	I20161442021	185	25/32 x 13/16	7,90
701611180	I20161442122	206	13/16 x 7/8	9,60
701611190	I20161442325	220	15/16 x 1	10,90
701611200	I20161442328	235,5	15/16 x 1-1/8	9,50
701611210	I20161442628	53,2	1-1/16 x 1-1/8	14,90
701611220	I20161442631	235,5	11/16 x 1,4	14,90
701611230	I20161442833	250	1-1/8 x 1-5/16	15,90



Steekslagsleutel.

Kenmerken:

- Chroom vanadium staal.
- Zwart verchromd.

Order nr.	Orig. nr.	Maat mm	Lengte mm	Prijs €
160740106	902024	24	178	18,90
160740205	902027	27	180	18,90
160740304	902030	30	190	23,50
160740403	902032	32	190	24,60
160740502	902036	36	214	30,80
160740601	902038	38	215	35,40
160740700	902041	41	233	36,60
160740809	902046	46	252	48,70
160740908	902050	50	275	54,90
160741005	902055	55	295	67,50
160741104	902060	60	315	83,50
160741203	902065	65	340	103,70
160741302	902070	70	370	130,60
160741401	902075	75	370	131,80
160741500	902080	80	397	277,30
160741609	902085	85	397	312,90
160741708	902090	90	444	364,40
160741807	902095	95	444	429,80
160741906	902100	100	488	515,70



Sleutelhouder.

Kenmerken:

- Vervaardigd uit metaal.
- Universeel model geschikt voor 12 sleutels.
- Perfect te bevestigen aan de muur.

Order nr.	709000044
Orig. nr.	I28001316012
Prijs €	17,50

Flexringsleutels

TENGOOLS



Dubbele flex-ringsleutels 12-kant.

Kenmerken:

- Teng Tools chroom vanadium staal.
- Matverchroomd.
- Verschillende maten aan beide uiteinden.

Order nr.	Orig. nr.	Maat mm	Maat inch	Lengte mm	Prijs €
72920200	650809	8x9		192	12,90
72920309	651011	10x11		200	13,90
72920358	651013	10x13		213	14,90
72920408	651213	12x13		218	14,90
72920507	651415	14x15		238	17,90
72920606	651617	16x17		264	19,50
72920705	651819	18x19		285	21,90
72921000	611214		3/8x7/16	200	14,90
72921109	611618		1/2x9/16	218	16,50
72921208	612022		5/8x11/16	264	21,50

TENGOOLS



Set van 6 dubbele flex-ringsleutels 12-kant gaande van 8 tot 19mm.

Kenmerken:

- Verschillende maten aan beide kanten.
- TC-tray.

Order nr.	73000101				
Orig. nr.	TT6506				
Aantal stuks	6				
Sleutels	mm	8x9 · 10x11 · 12x13 · 14x15 · 16x17 · 18x19			
Prijs	€	68,90			

TENGOOLS



Bi-flex sleutel. Met 1/4" hex-kant voor bitsen en 1/4" vierkant voor 1/4" doppen.

Kenmerken:

- Teng Tools chroom vanadium staal.
- Matverchroomd.

Geregistreerd product.

Order nr.	15580103	
Orig. nr.	691406	
Lengte	mm	200
Prijs	€	15,50

TENGOOLS



Set van 6 dubbele flex-ringsleutels 12-kant.

Kenmerken:

- Gaande van 8 tot 19mm.
- Geleverd met een wandrek voor montage op een muur of wandpaneel.

Order nr.	128230109	
Orig. nr.	WRDF06	
Kniesleutels	mm	8x9 · 10x11 · 12x13 · 14x15 · 16x17 · 18x19
Prijs	€	81,90

Opsteeksleutels

TENGOOLS



Flexibel handvat met ringratel-kop adaptor 12-kant.

Kenmerken:

- Teng Tools chroom vanadium staal.
- Matverchroomd.

Order nr.	118300102		
Orig. nr.	600010RI		
Lengte	mm	239	
Prijs	€	43,30	

TENGOOLS



Set van 8 opsteek-steeksleutels met 3/8" vierkant aansluiting gaande van 10 tot 19mm. Geleverd op een metalen rail met dopclips.

Order nr.	111990107		
Orig. nr.	M3808MM		
Maat	mm	10 · 11 · 12 · 13 · 16 · 17 · 18 · 19	
Aantal stuks	8		
Prijs	€	69,20	

TENGOOLS



Opsteek-steeksleutels met 3/8" vierkant aansluiting.

Kenmerken:

- Teng Tools chroom vanadium staal.
- Matverchroomd.

Order nr.	Orig. nr.	Maat mm	Maat inch	Lengte mm	Prijs €
112010103	M386510	10		32	10,10
112010202	M386511	11		34	10,10
112010301	M386512	12		36	11,70
112010400	M386513	13		37	10,20
112010509	M386514	14		40	10,60
112010608	M386515	15		41	10,80
112010707	M386516	16		41	12,90
112010806	M386517	17		45,5	11,90
112010905	M386518	18		45,5	12,30
112011002	M386519	19		45,5	13,20
112012000	M386112		3/8	30	8,60
112012208	M386116		1/2	36	8,90

Doorduwdoppen

TENGOOLS



Ratel voor doorduw doppen.

Kenmerken:

- Interne hex 19mm aansluiting.
- Links-rechts verstelling dmv een hendel op de ratel.

Order nr.	144120102		
Orig. nr.	M800010		
Lengte	mm	220	
Interne Hex aansluiting	mm	19	
Prijs	€	28,90	

TENGOOLS



Doorduw doppen 32mm 6-kant.

Kenmerken:

- Externe hex aansluiting 19mm.
- Chroom Vanadium.

De doppen zijn bedoeld voor gebruik met een lang-doorgaande draadstang.

Order nr.	Orig. nr.	Maat mm	Prijs €
144110103	M800510-C	10	7,30
144110202	M800511-C	11	7,30
144110301	M800512-C	12	7,50
144110400	M800513-C	13	6,80
144110509	M800514-C	14	7,90
144110608	M800515-C	15	8,50
144110707	M800516-C	16	9,60
144110905	M800518-C	18	10,20
144111002	M800519-C	19	10,20

TENGOOLS



Verlengstuk voor doorduw doppen. Te gebruiken samen met de doorduw-ratel M800010 en doorduw doppen M8005.

Order nr.	144130101		
Orig. nr.	M800023-C		
Aansluiting	inch	3/8	
Externe Hex aansluiting	mm	19	
Lengte	mm	75	
Prijs	€	11,80	

Montagesleutels



Montage ringsleutel.

Kenmerken:

- Gesmeed staal.
- Zwart gefosfateerd.

Order nr.	Orig. nr.	Maat	Lengte	Breedte ring	Hoogte ring	Prijs
		mm	mm	mm	mm	€
721401700	ASHRNKP17	17	320	26	9	13,90
721401900	ASHRNKP19	19	320	30	10	16,90
721402200	ASHRNKP22	22	335	34	12	16,50
721402400	ASHRNKP24	24	355	38	12	19,90
721402700	ASHRNKP27	27	370	42	14	22,50
721402900	ASHRNKP29	29	380	43	14	25,90
721403000	ASHRNKP30	30	390	46	14	29,50
721403200	ASHRNKP32	32	405	50	15	31,50
721403600	ASHRNKP36	36	440	56	16	38,90
721404100	ASHRNKP41	41	475	64	18	45,90



Montage ratel-pin sleutels.

Kenmerken:

- Gesmeed staal.
- Zwart gefosfateerd.

Order nr.	Orig. nr.	Maat	Breedte ring	Hoogte ring	Prijs
		mm	mm	mm	€
721391013	ASHRNKC1013	10x13	36	27	37,90
721391719	ASHRNKC1719	17x19	48	39	40,90
721391922	ASHRNKC1922	19x22	51	48	46,90
721392224	ASHRNKC2224	22x24	57	50	60,50
721392430	ASHRNKC2430	24x30	67	57	76,90
721392730	ASHRNKC2730	27x30	67	57	81,50
721393236	ASHRNKC3236	32x36	67	57	99,90

Haakpinsleutels



Set. TC-tray.

Bestaande uit:

- 3 haakpinsleutels met 3 pin adaptors
- 2 extra pinnen van 6 en 8mm.

Order nr.	102120102	
Orig. nr.	TTHP08	
Haakpinsleutels voor diameter	mm	19 - 50, 30 - 75, 50 - 120
Pin adapters met pin diameter	mm	4 - 5 - 6
Extra pinnen diameter	mm	6 - 8
Prijs	€	80,90



Haakpinsleutels DIN 1804.

Kenmerken:

- Verstelbaar met vaste haak.
- Teng Tools chroom vanadium staal.
- Matverchroomd.

Order nr.	Orig. nr.	Voor diameter	Lengte	Prijs
		mm	mm	€
112020102	HP101	19-50	145	18,50
112020201	HP102	32-75	178	27,90
112020300	HP103	50-120	247	35,50



Haakpinsleutels DIN 1816. Met vervangbare pin.

Kenmerken:

- Teng Tools chroom vanadium staal.
- Matverchroomd.

Order nr.	Orig. nr.	Voor diameter	Lengte	Pin diameter	Prijs
		mm	mm	mm	€
112030101	HP2014	19-50	145	4	24,50
112030200	HP2015	19-50	145	5	24,50
112030309	HP2025	32-75	178	5	32,90
112030408	HP2026	32-75	178	6	32,90
112030507	HP2036	50-120	247	6	38,50
112030606	HP2038	50-120	247	8	38,50



Accessoires. Pin voor Haakpsleutel met pen.

Vorkomt as- en borgmoerbeschadiging. Opening in het handvat voor gemakkelijke opslag.

Order nr.	Orig. nr.	Prijs
		€
801200600	HP2014-P	2,50
801200601	HP2015-P	3,00
801200603	HP2026-P	3,60
801200604	HP2036-P	3,60
801200605	HP2038-P	4,80

TOOLS

Schroefsleutels

TENGTOLS



Schroefsleutels.

Kenmerken:

- Teng Tools chroom vanadium staal.
- Zwart-gefosfateerd.
- Met maat-aanduiding aan de sleutelkant.

Order nr.	Orig. nr.	Capaciteit mm	Lengte mm	Prijs €
105870059	4001	17	100	14,50
105870109	4002	24	150	15,50
105870208	4003	28	200	18,90
105870307	4004	33	250	23,90
105870406	4005	38	300	29,90
105870505	4006	50	375	59,90
105870604	4007	60	450	92,50
105870703	4008	70	600	203,00

TENGTOLS



Industriële schroefsleutels.

Kenmerken:

- Chroom vanadium.
- Twee componenten handvat.
- Met schaalverdeling.
- Gefosfateerde afwerking.
- Dankzij de 15° gebogen bek kan de sleutel in beperkte ruimtes gebruikt worden met een draaiing van 30°.

Order nr.	Orig. nr.	Capaciteit mm	Lengte mm	Prijs €
178180105	4002IQ	24	157	17,50
178180204	4003IQ	28	206	20,90
178180303	4004IQ	33	255	26,90
178180402	4005IQ	38	305	32,50
178180501	4006IQ	50	380	67,90

TENGTOLS



Schroefsleutel met extra grote opening

Kenmerken:

- Cr. V. staal
- Hoek 15°
- Volgens standaarden ISO 6787, ASME B.107.8, BS6333, DIN3117, JIS B4604

Order nr.	Orig. nr.	Capaciteit mm	Lengte mm	Prijs €
199650102	4003J	32	202	28,50

TENGTOLS



Compacte en handige schroefsleutels - met groot bereik.

Kenmerken:

- Voorzien van een schaalverdeling.
- Met het nieuwe soft-+GRIP handvat voor een perfecte grip in de hand.

Order nr.	Orig. nr.	Lengte mm	Maximum opening mm	H mm	W mm	Prijs €
160380051	4002WT	172	34	30,0	63,5	24,50
160380101	4003WT	221	38	34,1	72,1	27,90
160380200	4004WT	274.6	50	41.0	92.1	36,50
160380309	4005WT	316.5	60	55.7	110.5	56,90

TENGTOLS



4-delige schroefsleutelset. Met schaalverdeling. TC-tray.

Order nr.	Orig. nr.	Capaciteit mm	Lengte mm	Prijs €
166730101	TTADJ04	24 - 28 - 33 - 38	150 - 200 (2x) - 250	70,90

Buizentangen

TENGTOLS



Buizentangen.

Kenmerken:

- Robuust aluminium uitvoering.
- Licht gewicht.

Order nr.	Orig. nr.	Lengte mm	Capaciteit mm	Maximum pijpdiameter inch	Prijs €
151810108	PW12A	300	39	19/16	30,50
151810207	PW14A	350	47	17/8	34,90
151810306	PW18A	450	63	2 1/2	48,90
151810405	PW24A	600	76	3	70,90
151810504	PW36A	900	127	5	167,00

IZELTAS



Buizen tang. Zweeds model.

Kenmerken:

- Tangbekken onder 85° hoek.
- Inductief nageharde bekken.
- Chroom vanadium staal.
- Rood gepoederlakt.

Order nr.	Orig. nr.	Lengte mm	Capaciteit mm	Prijs €
722011000	I22201240010	325	40	47,50
722011500	I22201240015	430	60	68,90
722012000	I22201240020	585	70	102,00
722013000	I22201240030	690	100	147,00

Allensleutels

TENGOOLS



28-delige allensleutelset MM, AF en TX. Geleverd in 3 handige sets.

Order nr.	128250107	
Orig. nr.	THT28	
Maat	inch	5/64 - 3/32 - 1/8 - 5/32 - 3/16 - 7/32 - 1/4 - 5/16 (1479AF) - 3/8
Maat	mm	1,5 - 2 - 2,5 - 3 - 4 - 5 - 6 - 8 - 10 (1479mm)
Maat TX		8 - 9 - 10 - 15 - 20 - 25 - 27 - 30 - 40 (1479TX)
Allensleutel met ball-point	mm	7
Afmetingen (l x b x h)	mm	265 x 142 x 50
Prijs	€	41,90

TENGOOLS



Set van 10 allensleutels gaande van 1,5 tot 10mm of 1/16" tot 3/8".

Kenmerken:

- Chroom vanadium staal.
- Zwart gefosfateerd.

Geleverd met een ringhouder.

Order nr.	105820104	105820203
Orig. nr.	1425	1424
Aantal sleutels	10	10
Sleutels	mm	1/16 - 5/64 - 3/32 - 1/8 - 5/32 - 3/16 - 6 - 7 - 8 - 10
		- 7/32 - 1/4 - 5/16 - 3/8
Prijs	€	7,10
		6,60

TENGOOLS



Set van 7 allensleutels met bolkop gaande van 2,5 tot 10mm of 1/8" tot 3/8".

Kenmerken:

- Chroom vanadium staal.
- Zwart gefosfateerd.

Geleverd in een handige kunststof houder.

Order nr.	109550103	109550202
Orig. nr.	1475	1474
Maat	mm	1/8 - 5/32 - 3/16 - 7/32 - 1/4 - 5/16 - 3/8
Aantal stuks	7	7
Sleutels	mm	2,5 - 3 - 4 - 5 - 6 - 8 - 10
Sleutels	inch	1/8 - 5/32 - 3/16 - 7/32 - 1/4 - 5/16 - 3/8
Prijs	€	13,90
		13,90

TENGOOLS



Set van 9 allensleutels met bolkop gaande van 1,5 tot 10mm of 5/64" tot 3/8".

Kenmerken:

- Chroom vanadium staal.
- Zwart gefosfateerd.

Geleverd in een handige samenvouwbare kunststof houder.

Order nr.	112260104	112260203
Orig. nr.	1479MM	1479AF
Maat	mm	1,5 - 2 - 2,5 - 3 - 4 - 5 - 6 - 8 - 10
Maat	inch	5/64 - 3/32 - 1/8 - 5/32 - 3/16 - 7/32 - 1/4 - 5/16 - 3/8
Aantal stuks	9	9
Prijs	€	19,50
		19,50

TENGOOLS



NEW

XXL

Set van 9 **extra lange** Allensleutels uit chroom vanadium staal. Maat op elke sleutel gemarkeerd. Geleverd in een kunststof

Order nr.	231740101	
Orig. nr.	1479MMRL	
Maat	mm	1,5-2,5-3-4-5-6-8-10
Aantal stuks	9	
Prijs	€	14,30

TOOLS

Cluna



XXL

Set van 9 extra-lange allensleutels. Maten van 2,5 tot 10 mm.

Kenmerken:

- Bolkop aan het lange uiteinde.
- Stalen-klemring om de allenbout vast te houden.

Deze bolkop-uitvoering geeft u de mogelijkheid om onder een hoek van 30° te werken.

Geleverd in een kunststof houder.

Order nr.	205150105		
Orig. nr.	205150105		
Aantal stuks	9		
Sleutels	mm	1,5 · 2 · 2,5 · 3 · 4 · 5 · 6 · 8 · 10	
Prijs	€	72,90	

Cluna



XXL

CrMo

14 allensleutels in setvorm.

Bestaande uit:

- 7 extra-lange allensleutels van 3 tot 14 mm
- 7 allensleutels van 1,5 tot 6 mm in boekvorm.

Kenmerken:

- Hoogwaardige professionele kwaliteit.
- Chroom molybdeen.
- Zwart gefosfateerd.

Made in Japan.

Order nr.	205630106		
Orig. nr.	205630106		
Aantal stuks	14		
Sleutels extra lang	mm	3 · 4 · 5 · 6 · 8 · 10 · 14	
Sleutels in boekvorm	mm	1,5 · 2 · 2,5 · 3 · 4 · 5 · 6	
Prijs	€	65,90	

TENGOOLS

NEW



Allensleutelsets in boekvorm.
Chroom vanadium staal.

Order nr.	Orig. nr.	Maat		Aantal sleutels	Prijs
		mm	inch		
231810102	1471MM	1,5-2,5-3-4-5-6		7	7,00
231810201	1471MMA	2,5-3-4-5-6-8-10		7	10,50
231810409	1471AF		1/16-5/64-3/32 1/8-5/32-3/16-7/32	7	7,00
231810508	1471AFA		1/8-5/32-3/16-1/4-5/16-3/8	6	10,30

TENGOOLS



7-delige allensleutelset in boekvorm gaande van 1,5 tot 6 mm of 1/16" tot 7/32".

Kenmerken:

- Chroom vanadium staal.
- Zwart gefosfateerd.
- In alu houder.

Order nr.	151470101	151470200	231810300
Orig. nr.	1476NMM	1476NAF	1476NMM1
Maat	mm	1,5 · 2 · 2,5 · 3 · 4 · 5 · 6	2,5-3-4-5-6-8-10
Maat	inch	1/16 · 5/64 · 3/32 · 1/8 · 5/32 · 3/16 · 7/32	
Aantal stuks	7	7	7
Prijs	€	11,90	11,70

TENGOOLS



Set van 8 sleutels in boekvorm plat, hex en TX.

Kenmerken:

- Chroom vanadium staal.
- Zwart gefosfateerd.

Order nr.	162670103		
Orig. nr.	1477NX		
Aantal sleutels	8		
Hex sleutel	mm	4 · 5 · 6	
TX sleutel	25 · 30		
PH sleutel	1		
Platte sleutel	mm	5,5	
PZ sleutel	2		
Prijs	€	20,90	

TENGOOLS



Fietsleutelset 11 delig.

Kenmerken:

- Chroom, nikel afwerking.
- In aluminium behuizing.

Order nr.	162640106		
Orig. nr.	1473		
Individuele accessoires	PH 2, TX25 Plat 1.0x5.5, Hex 2.0, 2.5, 3.0, 4.0, 5.0, 6.0	mm Bandenlichter Ketting tool	
Prijs	€	19,50	

TENGOOLS



L-vormige allensleutel.

Kenmerken:

- Chroom vanadium staal.
- Zwart gefosfateerd.

Order nr.	Orig. nr.	Maat		Lengte	Lengte	Prijs
		mm	inch	korte arm	lange arm	
116560103	3105007	0,7		8	35	0,50
116560202	3105009	0,9		10	38	0,40
116560301	3105013	1,3		12	41	0,40
116560400	3105015	1,5		14	45	0,40
116560509	310502	2		16	50	0,40
116560608	3105025	2,5		18	56	0,40
116560707	310503	3		20	63	0,40
116560806	310504	4		25	70	0,70
116560905	3105045	4,5		26	75	0,80
116561002	310505	5		28	80	1,00
116561101	3105055	5,5		30	85	1,00
116561200	310506	6		32	90	1,00
116561309	310507	7		34	95	1,30
116561408	310508	8		36	100	1,50
116561507	310509	9		38	106	1,70
116561606	310510	10		40	112	2,20
116561705	310512	12		45	125	4,30
116561804	310514	14		56	140	6,30
116561903	310517	17		63	160	9,60
116562000	310519	19		70	180	14,90
116562109	310522	22		80	200	13,80
116562208	310527	27		100	250	22,40
116562307	310532	32		125	315	44,00
116562406	310536	36		140	355	68,30
116570102	310102		1/16	14	44	0,40
116570201	3101025		5/64	15	48	0,40
116570300	310103		3/32	17	51	0,40
116570409	3101035		7/64	18	54	0,40
116570508	310104		1/8	19	57	0,40
116570607	3101045		9/64	20	60	0,40
116570706	310105		5/32	21	64	0,70
116570805	310106		3/16	24	70	0,80
116570904	310107		7/32	26	76	0,90
116571001	310108		1/4	28	83	1,10
116571100	310110		5/16	32	95	1,30
116571209	310112		3/8	35	108	1,90
116571308	310114		7/16	38	121	3,70
116571407	310116		1/2	41	133	4,90

TENGOOLS



XL

L-vormige allensleutel, **lange** uitvoering.

Kenmerken:

- Chroom vanadium staal.
- Zwart gefosfateerd.
- Met bolkop aan het lange uiteinde.

Deze bolkop-uitvoering geeft u de mogelijkheid onder een hoek van 30° te werken.

Order nr.	Orig. nr.	Maat		Lengte	Lengte	Prijs
		mm	inch	korte arm	lange arm	
122690100	3105015BL	1,5		14	77	1,90
122690209	310502BL	2		16	83	1,90
122690308	3105025BL	2,5		18	90	1,90
122690407	310503BL	3		20	98	2,00
122690506	310504BL	4		24	106	2,20
122690605	310505BL	5		28	118	2,50
122690704	310506BL	6		32	136	2,80
122690753	310507BL	7		34	147	3,40
122690803	310508BL	8		36	154	3,80
122690902	310510BL	10		40	172	5,20
177660107	3101025BL	2,0	5/64	15	82	1,40
177660206	310103BL	2,4	3/32	17	88	1,60
177660305	310104BL	3,2	1/8	19	96	1,70
177660404	310105BL	4,0	5/32	21	105	1,80
177660503	310106BL	4,8	3/16	24	114	1,90
177660602	310107BL	5,6	7/32	26	124	2,10
177660701	310108BL	6,4	1/4	28	135	2,30
177660800	310110BL	8,0	5/16	32	151	3,00
177660909	310112BL	9,5	3/8	35	170	3,80

TENGOOLS



NEW

XXL

Extra lange Allensleutel. Chroom vanadium staal. Maat op elke sleutel gemarkeerd.

Order nr.	Orig. nr.	Maat	Lengte	Lengte	Prijs
			korte arm	lange arm	
231730102	3205015	1,5	14	90	0,50
231730201	320502	2	16	100	0,50
231730300	3205025	2,5	18	112	0,80
231730409	320503	3	20	126	0,90
231730508	320504	4	25	140	1,10
231730607	320505	5	28	160	1,30
231730706	320506	6	32	180	1,60
231730805	320508	8	36	200	2,40
231730904	320510	10	40	224	3,70

TENGOOLS



NEW

CrMo

9 delige Allensleutelset met bolkop.

Kenmerken:

- Chroom molybdenum staal
- Maat op elke sleutel gemarkeerd
- Met bolkop aan het uiteinde van de lange been, om te kunnen draaien tot een hoek van 30°
- Geleverd in een opvouwbare kunststof etui

Order nr.	231760109	231770108
Orig. nr.	1499MM	1499AF
Maat	mm 1,5-2,2-3-4-5-6-8-10	5/64-3/32-1/8-5/32-3/16-7/32-1/4-5/16-3/8
Maat	inch	
Aantal stuks	9	9
Prijs	€ 20,50	20,50

TENGOOLS



NEW

CrMo

Allensleutels met bolkop.

Kenmerken:

- Chroom molybdenum staal
- Maat op de sleutel gemarkeerd
- Met bolkop aan het uiteinde van de lange been, om te kunnen draaien tot een hoek van 30°

Order nr.	Orig. nr.	Maat	Maat	Lengte korte arm	Lengte lange arm	Prijs
		mm	inch	mm	mm	€
231750100	3905015BL	1,5		14	77	1,80
231750209	390502BL	2		16	83	1,80
231750308	3905025BL			18	90	2,00
231750407	390503BL	3		20	98	2,30
231750506	390504BL	4		25	106	2,40
231750605	390505BL	5		28	118	2,70
231750704	390506BL	6		32	137	3,00
231750803	390508BL	8		36	156	3,90
231750902	390510BL	10		40	170	5,40
231790106	3901025BL		5/64	15	82	1,80
231790205	390103BL		3/32	17	88	2,00
231790304	390104BL		1/8	19	96	2,40
231790403	390105BL		5/32	21	105	2,40
231790502	390106BL		3/16	24	114	2,60
231790601	390107BL		7/32	26	124	2,80
231790700	390108BL		1/4	28	135	3,00
231790809	390110BL		5/16	32	151	3,80
231790908	390112BL		3/8	35	170	4,90

TENGOOLS



Set van 7 allensleutels met T-hendel gaande van 2.5 tot 8mm.

Kenmerken:

- Met bolkop aan de lange kant van de sleutel.
- TC-tray.

Order nr.	68930106
Orig. nr.	TTHX7
Aantal stuks	7
Sleutels	mm 2,5 - 3 - 4 - 5 - 6 - 7 - 8
Afmetingen (l x b x h)	mm 265 x 142 x 50
Prijs	€ 32,50

TENGOOLS



Set van 7 allensleutels met T-hendel gaande van 3/32" tot 5/16".

Kenmerken:

- Met bolkop aan de lange kant van de sleutel.
- TC-tray.

Order nr.	68930205
Orig. nr.	TTHX7AF
Aantal stuks	7
Maat	inch 3/32 - 1/8 - 5/32 - 3/16 - 7/32 - 1/4 - 5/16
Afmetingen (l x b x h)	mm 265 x 142 x 50
Prijs	€ 32,90

TENGOOLS



Set van 7 allensleutels met T-hendel. MM of AF.

Kenmerken:

- Met bolkop aan de lange kant van de sleutel, voor een 30° draaiing.

Geleverd op een wandrek. Voor montage op een muur of wandpaneel.

Order nr.	128260106	128260205
Orig. nr.	WRHEX07	WRHEX07AF
Aantal stuks	7	7
Sleutels	mm 2,5 - 3 - 4 - 5 - 6 - 7 - 8	
Sleutels	inch	3/32 - 1/8 - 5/32 - 3/16 - 7/32 - 1/4 - 5/16
Prijs	€ 36,90	35,50

TENGOOLS



L-vormige allensleutel met T-handvat.

Kenmerken:

- Chroom vanadium staal.
- Zwart gefosfateerd.
- Met bolkop aan het lange uiteinde.

Deze bolkop-uitvoering geeft u de mogelijkheid onder een hoek van 30° te werken.

Order nr.	Orig. nr.	Maat	Maat	Lengte korte arm	Lengte lange arm	Prijs
		mm	inch	mm	mm	€
101790053	510502	2		12	100	5,40
101790103	5105025	2,5		12	100	5,70
101790202	510503	3		12	100	5,70
101790301	510504	4		12	100	5,90
101790400	510505	5		15	150	6,90
101790509	510506	6		15	150	7,40
101790608	510507	7		15	150	8,90
101790707	510508	8		18	190	8,70
101790806	510510	10		20	200	13,90
101790905	510512	12		20	200	15,90
101792000	510103		3/32	12	100	5,50
101792109	510104		1/8	12	100	5,70
101792208	510105		5/32	12	100	6,10
101792307	510106		3/16	15	150	6,60
101792406	510107		7/32	15	150	7,40
101792505	510108		1/4	15	150	8,90
101792604	510110		5/16	18	190	9,10

Torxsleutels

TENGOOLS



Set van 9 L-vormige TX-sleutels. Gaande van TX8 tot TX40.

Kenmerken:

- chroom vanadium staal.
- Zwart gefosfateerd.

Geleverd in een handige opvouwbare kunststof houder. 1479TX1 is met bolkop.

Order nr.	116600107	161610100
Orig. nr.	1479TX	1479TX1
Aantal stuks	9	9
Sleutels TX	8 - 9 - 10 - 15 - 20 - 25 - 27 - 30 - 40	8 - 9 - 10 - 15 - 20 - 25 - 27 - 30 - 40
Prijs	€ 23,50	29,50

TENGOOLS



Set van 8 TX-sleutels in boekvorm. Gaande van TX9 tot TX40.

Kenmerken:

- Chroom vanadium staal.
- Zwart gefosfateerd.
- In alu houder.

1476NTX1 is met bolkop.

Order nr.	151480100	162650105
Orig. nr.	1476NTX	1476NTX1
Aantal stuks	8	8
Sleutels TX	9 - 10 - 15 - 20 - 25 - 27 - 30 - 40	9 - 10 - 15 - 20 - 25 - 27 - 30 - 40
Prijs	€ 16,90	25,90

TENGOOLS



Set van 7 TX-sleutels. Gaande van TX8 tot TX40.

Kenmerken:

- Chroom vanadium staal.
- Zwart gefosfateerd.

Geleverd met een ringhouder.

Order nr.	105830103
Orig. nr.	1487
Aantal stuks	7
Sleutels TX	10 - 15 - 20 - 25 - 27 - 30 - 40
Prijs	€ 13,50

TENGOOLS



TX L-sleutels.

Kenmerken:

- Chroom vanadium staal.
- Zwart gefosfateerd.
- Beide kanten gefreesd.

Order nr.	Orig. nr.	Lengte mm	Maat TX	Prijs €
172830101	320008	16x80	8	2,50
172830200	320009	16x83	9	2,50
172830309	320010	17x86	10	2,60
172830408	320015	18x90	15	2,80
172830507	320020	19x95	20	2,90
172830606	320025	20x10	25	3,20
172830705	320027	22x105	27	3,40
172830804	320030	24x114	30	3,70
172830903	320040	26x124	40	4,00
172831000	320045	29x133	45	4,80
172831109	320050	32x152	50	5,50

TENGOOLS



L-vormige Torx-ballpoint sleutel.

Kenmerken:

- Chroom vanadium staal.
- Zwart gefosfateerd.
- Met balkop aan het lange uiteinde.

Deze balkop-uitvoering geeft u de mogelijkheid onder een hoek van 20° te werken.



Order nr.	Orig. nr.	Lengte mm	Maat TX	Prijs €
166980102	3200BL TX8	16x80	8	3,10
166980201	3200BL TX9	16x83	9	3,10
166980300	3200BL TX10	17x86	10	3,10
166980409	3200BL TX15	18x90	15	3,10
166980508	3200BL TX20	19x95	20	3,20
166980607	3200BL TX25	20x100	25	3,20
166980706	3200BL TX27	22x105	27	3,30
166980805	3200BL TX30	24x114	30	4,10
166980904	3200BL TX40	26x124	40	3,60
166981001	3200BL TX45	29x133	45	4,60
166981100	3200BL TX50	32x152	50	4,90

TENGOOLS



NEW

CrMo

9 delige Torx sleutelset.

Kenmerken:

- Chroom molybdenum staal
- Maat op elke sleutel gemarkeerd
- Met balkop aan het uiteinde van de lange been, om te kunnen draaien tot een hoek van 20°
- Geleverd in een opvouwbare kunststof etui

Order nr.	231780107
Orig. nr.	1499TX
Aantal stuks	9
Maat TX	8-9-10-15-20-25-27-30-40
Prijs	€ 33,30

TENGOOLS



NEW

CrMo

8 delige Torx sleutelset in boekvorm.

Kenmerken:

- Chroom molybdenum staal
- Maat op elke sleutel gemarkeerd
- Met TX balkop aan het uiteinde van de lange been, om te kunnen draaien tot een hoek van 20°

Order nr.	231810607
Orig. nr.	1476NTX2
Maat TX	9-10-15-20-25-27-30-40
Prijs	€ 17,70

TENGOOLS



NEW

CrMo

Torxsleutels met balkop.

Kenmerken:

- Chroom molybdenum staal
- Maat op de sleutel gemarkeerd
- Met balkop aan het uiteinde van de lange been, om te kunnen draaien tot een hoek van 20°

Order nr.	Orig. nr.	Maat TX	Lengte korte arm mm	Lengte lange arm mm	Prijs €
231800103	390908BL	8	16	80	4,10
231800202	390909BL	9	16	83	4,10
231800301	390910BL	10	17	86	4,20
231800400	390915BL	15	18	90	4,20
231800509	390920BL	20	19	95	4,30
231800608	390925BL	25	20	100	4,30
231800707	390927BL	27	22	105	4,40
231800806	390930BL	30	24	114	4,50
231800905	390940BL	40	26	124	4,80

TENGOOLS



Set van 7 sluetels TX/TPX met T-hendel. TC-tray.

Kenmerken:

- Gaande van TX-TPX10 tot TX-TPX40.
- Met TPX aan de korte kant van de sluetel.

Order nr.	68920107		
Orig. nr.	TTX7		
Aantal stuks	7		
Sluetels TX	10 · 15 · 20 · 25 · 27 · 30 · 40		
Afmetingen (l x b x h)	mm	265 x 142 x 50	
Prijs	€	31,90	

TENGOOLS



Set van 7 sluetels TX/TPX met T-hendel.

Kenmerken:

- Gaande van TX10 tot TX40.
- Met TPX aan de korte kant van de sluetel.

Geleverd met een wandrek voor montage op een muur of wandpaneel.



Order nr.	128270105		
Orig. nr.	WRTX07		
Sluetels	TX-TPX	10 · 15 · 20 · 25 · 27 · 30 · 40	
Prijs	€	29,90	

TENGOOLS



L-vormige TX-TPX sluetel met T-handvat.

Kenmerken:

- Chroom vanadium staal.
- Zwart gefosfateerd.
- Met TPX-maten aan de korte kant van de sluetel.

Order nr.	Orig. nr.	Lengte mm	Maat TX/TPX	Prijs €
101800050	520009	12x100	9	5,10
101800100	520010	12x100	10	5,10
101800209	520015	12x100	15	5,10
101800308	520020	12x100	20	5,10
101800407	520025	15x150	25	5,80
101800506	520027	15x150	27	5,90
101800605	520030	15x150	30	6,50
101800704	520040	18x190	40	7,40
101800803	520045	20x200	45	7,70
101800902	520050	20x200	50	10,00
101801009	520055	20x200	55	12,50

Dopschroevendraaiers

TENGOOLS



Set van 9 Mega Drive schroevendraaiers op dop 6-kant gaande van 5 tot 13mm.

Kenmerken:

- Met een ergonomisch zwart-rood twee componenten handvat.
- TTX-tray.

Order nr.	114590102		
Orig. nr.	TTXMDN		
Maten	mm	5 · 5,5 · 6 · 7 · 8 · 10 · 11 · 12 · 13	
Prijs	€	67,50	

TENGOOLS



Mega Drive schroevendraaiers op dop 6-kant.

Kenmerken:

- Ergonomisch zwart-rood twee componenten handvat.

Order nr.	Orig. nr.	Maat mm	Lengte schacht mm	Lengte handvat mm	Prijs €
112680103	MDN405	5	125	120	9,80
112680202	MDN4055	5,5	125	120	9,90
112680301	MDN406	6	125	120	9,80
112680400	MDN407	7	125	120	10,90
112680509	MDN408	8	125	120	10,30
112680608	MDN410	10	125	120	10,50
112680707	MDN411	11	125	120	10,90
112680806	MDN412	12	125	120	11,70
112680905	MDN413	13	125	120	11,70

TENGOOLS



Sluetel met T-handvat met lange dop 6-kant.

Kenmerken:

- Teng Tools chroom vanadium staal.
- Matverchroomd.
- Ergonomisch zwart-rood twee componenten handvat.
- Lengte 288mm.

Order nr.	Orig. nr.	Maat mm	Prijs €
132180100	MDNT405	5	10,50
132180209	MDNT4055	5,5	10,40
132180308	MDNT406	6	10,40
132180407	MDNT407	7	10,90
132180506	MDNT408	8	11,70
132180605	MDNT409	9	12,20
132180704	MDNT410	10	12,80
132180803	MDNT411	11	12,80
132180902	MDNT412	12	14,00
132181009	MDNT413	13	14,00
132181108	MDNT414	14	16,20

SCHROEVENDRAAIERS

De schachten van de Teng Tools schroevendraaiers zijn gemaakt van TT-MV-PLUS materiaal, deze geven een 20 tot 30% hogere torsie dan normaal chroom vanadium staal.

TT-MV-PLUS is een speciaal molybdenum materiaal dat een 56 Rockwell harding heeft. Onafhankelijke testen tonen aan dat de Teng Tools schroevendraaiers tot de beste klasse horen. Dit komt onder andere door de hogere torsie en het moment van het breken.

- De zeskant schacht op de langere maten heeft het voordeel dat men er een steeksleutel of schroef sleutel op kan zetten voor nog meer torsie en kracht.
- Leverbaar in diverse soorten en maten, de tips zijn voorzien van een gefosfateerde beschermlaag.
- Ronde en elips gevormde handgrepen voor een perfect aandraaimoment.
- De schroevendraaiers hebben een ophangoog die tevens ook de mogelijkheid geeft om hem als T-greep te gebruiken.
- De Megadrive schroevendraaiers zijn verkrijgbaar met PH, PZ, Torx TX, Torx TPX, Sleufkop en Robinson kop.
- Ook mini(horloge/telefoon) schroevendraaiers en slagschroevendraaiers (MDT serie) zitten in het assortiment. Deze hebben een 6-kant schacht om aan te spannen met behulp van een sleutel. Alleen leverbaar met sleufkop en PH kop.
- De Megadrive schroevendraaiers zijn los verkrijgbaar, in sets en in de Teng Tools tool trays.



LIKE CLOCKWORK ACCORDING TO TENG



ANNA, Maintenance Engineer

Production stops made for a bad day. You want the manufacturing process to flow like it should. To get that, you need a perfectly tuned workstation. For some, things organised perfectly might seem boring, but when it comes to get things to run like clockwork, it's vital. Welcome to our world!

Get organised™



Schroevendraaiers

TENGOOLS



53-delige Super Mega Drive Set.

Bestaande uit:

- 19 schroevendraaiers plat, PH en PZ
- 1 bitsratel
- 33 bitsen

Kenmerken:

- L.25mm.
- Ergonomisch zwart-rood twee componenten handvat.

Geleverd in een handige afsluitbare kunstof koffer.

Order nr.	144310109
Orig. nr.	MD9053N
Schroevendraaiers Plat	mm 10x200 - 8x150 - 6,5x150 - 6,5x100 - 5,5x150 - 5,5x75 - 4x100 - 3x100 - 3x75 - 6x38 (stubby)
Bitsen PZ	0
Aantal stuks	53
Bitschroevendraaier met bitsen Plat	mm 1,2x5 - 1,4x7
Schroevendraaiers PH	1x75 - 2x100 - 2x38 - 3x150
Schroevendraaiers PZ	0x75 - 1x75 - 2x100 - 2x38 - 3x150
Bitschroevendraaier met bitsen PH	1 - 2
Bitschroevendraaier met bitsen PZ	1 - 2
Bitsen TX	6 - 7 - 8 - 9 - 10 - 15 (x2) - 20 (x2) - 27 - 30 - 40
Bitsen TPX	20 - 25 - 30
Bitsen SQ	1 - 2 - 3
Bitsen Hex	mm 2 - 3 - 4 - 5 - 6 - 8
Prijs	€ 96,50

TENGOOLS



Set van 10 schroevendraaiers Plat, PZ en PH.

Kenmerken:

- Met een ergonomisch zwart-rood twee componenten handvat.

Geleverd in een kunstof afsluitbare koffer.

Order nr.	185880101
Orig. nr.	MD910N
Schroevendraaiers Plat	mm 3,0x100 - 5,5x75 - 5,5x150 - 6,5x150
Schroevendraaiers PH	mm 0x75 - 1x75 - 2x100
Schroevendraaiers PZ	mm 1x75 - 2x100
Schroevendraaiers Plat 1000 volt	mm 3,0x100
Prijs	€ 40,90

TENGOOLS



Set van 6 schroevendraaiers plat, PZ en PH.

Kenmerken:

- Ergonomisch zwart-rood twee componenten handvat.

Geleverd in een kunstof tray.

Order nr.	178200101
Orig. nr.	MD906N
Schroevendraaiers Plat	mm 0,6x3,5x75 - 1,0x5,5-150
Schroevendraaiers PH	mm 1x75 - 2x100
Schroevendraaiers PZ	mm 1x75 - 2x100
Prijs	€ 22,90

TENGOOLS



Set van 6 schroevendraaiers TX.

Kenmerken:

- Ergonomisch zwart-rood twee componenten handvat.

Geleverd in een kunstof tray.

Order nr.	178200200		
Orig. nr.	MD906N1		
Schroevendraaiers TX	mm	10x100 - 15x100 - 20x100 - 25x100 - 30x100 - 40x100	
Prijs	€	25,90	

TENGOOLS



Set van 6 schroevendraaiers TX en PZ.

Kenmerken:

- Ergonomisch zwart-rood twee componenten handvat.

Geleverd in een kunstof tray.

Order nr.	185890100		
Orig. nr.	MD906N2		
Schroevendraaiers PZ	mm	1x75 - 2x100	
Schroevendraaiers TX	mm	10 - 15 - 20 - 25	
Prijs	€	21,50	

TENGOOLS



Set van 6 Mega Drive schroevendraaiers plat en PH.

Kenmerken:

- Ergonomisch zwart-rood twee componenten handvat.

Geleverd in een handige kunstof koffer. Ook verkrijgbaar in display.

Order nr.	185900107		
Orig. nr.	MD906N3		
Schroevendraaiers Plat	mm	0,5x3,75mm - 1x5,5,75mm - 1,2x6,5-100mm	
Schroevendraaiers PH	mm	0x75 - 1x75 - 2x100	
Prijs	€	19,90	

TENGOOLS



Set van 6 schroevendraaiers Plat en PZ.

Kenmerken:

- Ergonomisch zwart-rood twee componenten handvat.

Geleverd in een kunstof tray.

Order nr.	185910106		
Orig. nr.	MD906N4		
Schroevendraaiers Plat	mm	3.0x75 - 4.0x100 - 5.5x75 - 6.5x100	
Schroevendraaiers PZ	mm	1x75 - 2x100	
Prijs	€	19,90	

TENGOOLS



Set van 12 schroevendraaiers plat, PH en PZ.

Kenmerken:

- Ergonomisch zwart-rood twee componenten handvat.

Geleverd in een kunstof tray.

Order nr.	178210100		
Orig. nr.	MD912N		
Schroevendraaiers Plat	mm	0,5x2,5x75 - 0,6x3,5x100 - 0,8x4,0x150 - 1,0x5,5x150 - 1,2x6,5x150 - 1,6x10x200	
Schroevendraaiers PH	mm	0(x75) - 1(x75) - 2(x100) - 2(x200)	
Schroevendraaiers PZ	(mm)	1(x75) - 2(x100)	
Prijs	€	42,50	

TENGOOLS



Set van 12 schroevendraaiers Plat, PH, PZ en TX. Drie 1000V geïsoleerde schroevendraaiers.

Kenmerken:

- Ergonomisch zwart-rood twee componenten handvat.

Geleverd in een kunstof tray.

Order nr.	178210209		
Orig. nr.	MD912N1		
Schroevendraaiers Plat	mm	0,5x3,0x75 - 0,6x3,5-100 - 1,0x5,5x150	
Schroevendraaiers PH	mm	1(x75) - 2(x100)	
Schroevendraaiers TX	mm		
Schroevendraaiers PZ	(mm)	2(x100)	
Schroevendraaiers geïsoleerd PH	(mm)	1(x80)	
Schroevendraaiers geïsoleerd Plat	mm	0,4x2,5x75 - 0,5x3x100	
Prijs	€	41,50	

TENGOOLS



Set van 10 Mega Drive schroevendraaiers plat, Ph en Pz.

Kenmerken:

- Ergonomisch zwart-rood twee componenten handvat.

Geleverd met een wandrek voor montage op een muur of wandpaneel.

Order nr.	174510107
Orig. nr.	WRMD10N
Schroevendraaiers Plat	mm 0,5x3,0x100 - 1,0x5,5x75 - 1,0x5,5x150 - 1,2x6,5x150 - 1,2x8,0x150
Schroevendraaiers PH	0x75 - 1x75 - 2x100
Schroevendraaiers PZ	1x75 - 1x100
Prijs	€ 49,50

TENGOOLS



Set van 14 schroevendraaiers plat, PH en PZ in Teng TTD tray.

Kenmerken:

- Met een ergonomisch zwart-rood twee componenten handvat.

Order nr.	174370106
Orig. nr.	TTD914N
Schroevendraaiers Plat	mm 0,5x3x75 - 0,6x3,5x100 - 1,0x5,5x75 - 1,2x6,5x38 - 1,0x5,5x125 - 1,2x6,5x100
Schroevendraaiers PH	mm 0(x75) - 1(x75) - 2(x38) - 2(x100)
Schroevendraaiers PZ	(mm) 0(x75) - 1(x75) - 2(x38) - 2(x100)
Afmetingen (l x b x h)	mm 265 x 142 x 50
Prijs	€ 53,50

TENGOOLS



Set van 7 schroevendraaiers plat, PH en PZ. TT-MV PLUS staal.

Kenmerken:

- Ergonomisch twee componenten handvat met ophanggat.
- TC tray.

Order nr.	174400101
Orig. nr.	TT917N
Schroevendraaiers Plat	mm 0,5x3x75 - 1x5,5x75 - 0,2x6,5x100
Schroevendraaiers PH	mm 0x75 - 1x75 - 2x75
Schroevendraaiers PZ	mm 2x100
Prijs	€ 27,90

TENGOOLS



5-delige schroevendraaierset plat en PH waarvan 2 stubby. TTX-tray.

Order nr.	174500108
Orig. nr.	TTX918N
Schroevendraaiers Plat	mm 1,2x6,5x38 - 0,5x3x100 - 1,2x6,5x100 - 1,6x10x200 - 1,0x5,5x150 - 1,2x8x150
Schroevendraaiers PH	mm 2x38 - 3x150
Prijs	€ 45,50

TENGOOLS



Set van 12 schroevendraaiers TX in Teng TTD tray.

Kenmerken:

- Met een ergonomisch zwart-rood twee componenten handvat.

Order nr.	174380105
Orig. nr.	TTD912TXN
Schroevendraaiers TX	mm 6(x75) - 7(x75) - 8(x75) - 9(x75) - 10(x100) - 15(x100) - 20(x100) - 25(x100) - 27(x100) - 30(x100) - 40(x100) - 45(x100)
Afmetingen (l x b x h)	mm 265 x 142 x 50
Prijs	€ 52,50

TENGOOLS



Set van 7 TX/TPX schroevendraaiers.

Kenmerken:

- TT-MV PLUS staal.
- Ergonomisch twee componenten handvat met ophanggat.
- TC tray.

Order nr.	174410100
Orig. nr.	TT917TXN
Schroevendraaiers TX	mm 8(x75) - 9(x75)
Schroevendraaiers TPX	(mm) 10(x100) - 15(x100) - 20(x100) - 25(x100) - 30(x100)
Afmetingen (l x b x h)	mm 265 x 142 x 50
Prijs	€ 27,50

TENGOOLS

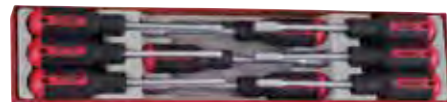

Set van 9 Mega Drive schroevendraaiers op dop 6-kant gaande van 5 tot 13mm.

Kenmerken:

- Met een ergonomisch zwart-rood twee componenten handvat.
- TTX-tray.

Order nr.	114590102
Orig. nr.	TTXMDN
Maten	mm 5 - 5,5 - 6 - 7 - 8 - 10 - 11 - 12 - 13
Prijs	€ 67,50



TENGOOLS



Schroevendraaier met TT-MV PLUS stalen schacht.

Kenmerken:

- Zwarte tip.
- De punten tot 0,8 mm zijn parallel, de grotere zijn uitlopend.
- Ergonomisch twee-componenten handvat met ophanggat.

Order nr.	Orig. nr.	Lengte schacht	Lengte handvat	Schacht	Maat plat	Handvat type	Type	Prijs
		mm	mm		mm			€
177760105	MD914N	50	96	Rond	0.4x2.5	B	plat	3,80
177760204	MD915N	75	96	Rond	0.4x2.5	B	plat	3,80
177760303	MD915N1	200	96	Rond	0.5x2.5	B	plat	4,90
177760402	MD920N	75	96	Rond	0.5x3.0	B	plat	4,20
177760501	MD920N1	100	96	Rond	0.5x3.0	B	plat	4,60
177760600	MD916N	75	96	Rond	0.6x3.5	B	plat	4,20
177760709	MD916N1	100	96	Rond	0.6x3.5	B	plat	4,60
177760808	MD916N2	150	96	Rond	0.6x3.5	B	plat	5,00
177760907	MD917N	100	96	Rond	0.8x4.0	B	plat	4,60
177761004	MD917N1	400	96	Rond	0.8x4.0	B	plat	7,10
177761103	MD917N2	150	96	Rond	0.8x4.0	B	plat	5,10
177761152	MD922N	75	108	Rond	1.5x5.5	C	plat	5,80
177761202	MD923N	150	108	Rond	1.0x5.5	C	plat	6,20
177761301	MD923N1	200	108	Rond	1.0x5.5	C	plat	6,90
177761400	MD928N	38	58	rond	1,2x6,5	A	plat	5,20
177761509	MD928N1	100	116	Rond	1.2x6.5	D	plat	7,10
177761608	MD928N2	150	116	Rond	1.2x6.5	D	plat	7,60
177761707	MD928N3	200	116	Rond	1.2x6.5	D	plat	8,30
177761558	MD928N4	100	108	Rond	1.2x6.5	C	plat	6,90
177761657	MD928N5	150	108	Rond	1.2x6.5	C	plat	7,40
177761756	MD928N6	200	108	Rond	1.2x6.5	C	plat	8,30
177762259	MD928N7	400	108	Rond	1.2x6.5	C	plat	11,70
177761806	MD930N	200	125	Rond	1.6x10	E	plat	12,20
177761905	MD931N	125	108	Hex	1.0x5.5	C	plat	6,90
177762002	MD932N	100	116	Hex	1.2x6.5	D	plat	7,30
177762101	MD932N1	150	116	Hex	1.2x6.5	D	plat	7,90
177762200	MD932N2	400	116	Hex	1.2x6.5	D	plat	18,90
177762309	MD934N	150	125	Hex	1.2x8.0	E	plat	10,20
177762408	MD935N	200	125	Hex	1.6x10.0	E	plat	12,80

TENGOOLS



Schroevendraaier met ronde of zeskant schacht uit TT-MV PLUS staal. Zwarte tip. Ergonomisch twee-componenten handvat met ophanggat.

Order nr.	Orig. nr.	Lengte schacht	Lengte handvat	Schacht	Maat PH	Handvat type	Type	Prijs
		mm	mm					€
177770104	MD940N	75	96	Rond		B	PH	4,20
177770203	MD940N1	300	96	Rond	0	B	PH	6,20
177770401	MD947N1	75	108	Rond	1	C	PH	5,70
177770500	MD947N2	150	108	Rond	1	C	PH	6,20
177770708	MD948N1	100	116	Rond	2	D	PH	7,10
177770807	MD948N2	200	116	Rond	2	D	PH	8,30
177770906	MD948N3	400	116	Rond	2	D	PH	11,70
177770757	MD948N4	100	108	Rond	2	C	PH	6,90
177770856	MD948N5	200	108	Rond	2	C	PH	8,00
177770955	MD948N6	400	108	Rond	2	C	PH	11,70
177770831	MD948N8	300	108	Rond	2	C	PH	9,70
177771003	MD949N	150	125	Rond	3	E	PH	9,90
177771102	MD950N	200	125	Rond	4	E	PH	12,20
177771201	MD952N	100	116	Hex	2	D	PH	7,50
177771300	MD952N1	400	116	Hex	2	D	PH	18,90
177771409	MD953N	150	125	Hex	3	E	PH	10,20
177771508	MD954N	200	125	Hex	4	E	PH	12,80

TENGOOLS



Schroevendraaier.

Kenmerken:

- Met ronde of zeskant schacht uit TT-MV PLUS staal.
- Zwarte tip.
- Ergonomisch twee-componenten handvat met ophanggat.

Order nr.	Orig. nr.	Lengte schacht	Lengte handvat	Maat PZ	Schacht	Handvat type	Type	Prijs
		mm	mm					€
177780103	MD960N	75	96	0	Rond	B	PZ	4,20
177780202	MD961N	75	108	1	Rond	C	PZ	5,70
177780301	MD961N1	250	108	1	Rond	C	PZ	7,30
177780509	MD962N	100	116	2	Rond	D	PZ	7,10
177780608	MD962N1	150	116	2	Rond	D	PZ	7,50
177780707	MD962N2	100	116	2	Hex	D	PZ	7,30
177780459	MD962N4	100	108	2	Rond	C	PZ	7,00
177780467	MD962N4A	200	108	2	Rond	C	PZ	8,00
177780483	MD962N4C	300	108	2	Rond	C	PZ	9,70
177780491	MD962N4D	400	108	2	Rond	C	PZ	11,70
177780475	MD962N5	150	108	3	Rond	C	PZ	7,40
177780905	MD963N	150	125	3	Hex	E	PZ	10,20
177781002	MD964N	200	125	4	Hex	E	PZ	9,70

TENGOOLS



Schroevendraaier met TPX tip.

Kenmerken:

- Ronde schacht uit TT-MV PLUS staal.
- Zwarte tip.
- Ergonomisch twee-componenten handvat met ophanggat.

Order nr.	Orig. nr.	Lengte schacht mm	Lengte handvat mm	Maat TX	Handvat type	Type	Prijs €
177790102	MD906TN	75	96	6	B	TX	4,70
177790201	MD907TN	75	96	7	B	TX	4,70
177790300	MD908TN	75	96	8	B	TX	4,70
177790409	MD909TN	75	96	9	B	TX	4,70
177790508	MD910TN	100	108	10	C	TX	6,00
177790607	MD915TN	100	108	15	C	TX	6,00
177790706	MD920TN	100	108	20	C	TX	6,00
177790805	MD925TN	100	116	25	D	TX	7,40
177790904	MD927TN	100	116	27	D	TX	7,40
177791001	MD930TN	100	116	30	D	TX	7,40
177791100	MD940TN	100	116	40	D	TX	7,40
177791209	MD945TN	125	125	45	E	TX	10,40

TOOLS

TENGOOLS



Schroevendraaier voor TPX veiligheidsschroeven.

Kenmerken:

- Ronde schacht uit TT-MV PLUS staal.
- Zwarte tip.
- Ergonomisch twee-componenten handvat met ophanggat.

Order nr.	Orig. nr.	Lengte schacht mm	Lengte handvat mm	Handvat type	Maat TPX	Type	Prijs €
177800109	MD610TPN	100	108	C	10	TPX	6,40
177800208	MD615TPN	100	108	C	15	TPX	6,40
177800307	MD620TPN	100	108	C	20	TPX	6,40
177800406	MD625TPN	100	116	D	25	TPX	7,70
177800505	MD627TPN	100	116	D	27	TPX	7,70
177800604	MD630TPN	100	116	D	30	TPX	6,80
177800703	MD640TPN	100	120	D	40	TPX	7,90

TENGOOLS



Schroevendraaier.

Kenmerken:

- Ronde schacht uit TT-MV PLUS staal.
- Zwarte tip.
- Ergonomisch twee-componenten handvat met ophanggat.

Order nr.	Orig. nr.	Lengte schacht mm	Lengte handvat mm	Schacht intern mm	Hex mm	Handvat type	Type	Prijs €
177810108	MD7020HN	100	96	Rond	2	B	Hex	4,10
177810207	MD7025HN	100	96	Rond	2,5	B	Hex	4,10
177810306	MD7030HN	100	96	Rond	3	B	Hex	4,20

TENGOOLS



Schroevendraaier.

Kenmerken:

- Zeskant tip met balpen Allen voor een draaiing tot een hoek van 30°.
- Ronde schacht uit TT-MV PLUS staal.
- Zwarte tip.
- Ergonomisch twee-componenten handvat met ophanggat.

Order nr.	Orig. nr.	Lengte schacht mm	Lengte handvat mm	Schacht mm	Maat Hex mm	Handvat type	Type	Prijs €
177820107	MD7020HBN	100	96	Rond	2	B	Hex	4,20
177820206	MD7025HBN	100	96	Rond	2,5	B	Hex	4,20
177820305	MD7030HBN	150	96	Rond	3	B	Hex	4,80
177820404	MD7040HBN	150	108	Rond	4	C	Hex	5,20
177820503	MD7050HBN	150	116	Rond	5	D	Hex	6,20
177820602	MD7060HBN	150	116	Rond	6	D	Hex	8,30
177820701	MD7080HBN	150	125	Rond	8	E	Hex	11,20

TENGOOLS



Schroevendraaier voor vierkante koppen zoals Robertson type.

Kenmerken:

- Met een ronde schacht uit TT-MV PLUS staal.
- Zwarte tip.
- Ergonomisch twee-componenten handvat met ophanggat.

Order nr.	Orig. nr.	Lengte schacht mm	Lengte handvat mm	Maat Rob	Handvat type	Type	Prijs €
177830106	MD801N	100	116	1	D	Rob	7,00
177830205	MD802N	100	116	2	D	Rob	7,00
177830304	MD803N	100	116	3	D	Rob	7,00

TENGOOLS



Set van 5 schroevendraaiers met doorgaande schacht uit TT-MV PLUS staal.

Kenmerken:

- Ergonomisch twee-componenten handvat.

Geleverd met een wandrek voor opknoping op een paneel of muur.

Order nr.	185970100	
Orig. nr.	WRMDT05N	
MDT932N plat	mm	1,2x6,5x100
MDT934N plat	mm	1,2x8x150
MDT935N plat	mm	1,6x10x200
MDT952N PH	mm	2x100
MDT953N PH	mm	3x150
Prijs	€	32,90

TENGOOLS



Slagschroevendraaier.

Kenmerken:

- Een TT-MV PLUS stalen doorlopende schacht E
- Een stalen dop op handvat.
- Zeskant schacht (laat het gebruik van een sleutel toe om deze goed vast te houden)
- Ergonomisch twee-componenten handvat met ophanggat.

Order nr.	Orig. nr.	Lengte schacht mm	Lengte handvat mm	Scha- cht plat mm	Maat plat mm	Hand- vat type	Type	Prijs €
177840105	MDT932N	100	116	Hex	1.2x6.5	D	plat	8,10
177840204	MDT934N	150	125	Hex	1.2x8	E	plat	11,70
177840303	MDT935N	200	125	Hex	1.6x10	E	plat	13,30

TENGOOLS



Slagschroevendraaier.

Kenmerken:

- Een TT-MV PLUS stalen doorlopende schacht.
- Een stalen dop op handvat.
- De zeskant schacht laat het gebruik van een sleutel toe om deze goed vast te houden.
- Ergonomisch twee-componenten handvat met ophanggat.

Order nr.	177840402	177840501
Orig. nr.	MDT952N	MDT953N
Lengte schacht	mm	100
Lengte handvat	mm	116
Schacht		Hex
Handvat type		D
Type		PH
Prijs	€	8,10
		11,70

TENGOOLS



5-delige set power-thru schroevendraaierset plat en PH met zeskant schacht en slagdop. TTX-tray.

Order nr.	174490102	
Orig. nr.	TTXMDTN	
Schroevendraaiers Plat	mm	1,2x6,5x100 - 1,2x8,0x150 - 1,6x10x200
Schroevendraaiers PH	mm	2x100 - 3x150
Afmetingen (l x b x h)	mm	560 x 110 x 40
Prijs	€	37,50

TENGOOLS



16-delige set bestaande uit 12 mini-schroevendraaiers Plat, Ph en Tx en 4 mini-tangen. TC-tray.

Order nr.	104450101	
Orig. nr.	TTM116	
Schroevendraaiers Plat	mm	2,0x40 - 2,4x40 - 3,0x40
Schroevendraaiers PH	mm	00(x40) - 0(x40)
Schroevendraaiers TX	mm	
Tang kopknip	mm	114
Zijknijplang	mm	125
Lange bektang	mm	125
Prijs	€	61,50

TENGOOLS



Set van 6 mini-schroevendraaiers Plat en PH. TT-MV staal. Zwarte tip. Geleverd met een rekje voor wandmontage.

Order nr.	68940105	
Orig. nr.	MDM706	
Schroevendraaiers Plat	mm	2x40 - 2,4x40 - 3x40
Schroevendraaiers PH		00 - 0 - 1
Prijs	€	16,50

TENGOOLS



Set van 6 mini-schroevendraaiers. TT-MV staal. Zwarte tip. Geleverd met een rekje voor wandmontage.

Order nr.	102150109	
Orig. nr.	MDM706TX	
Schroevendraaiers TX		6 - 7 - 8 - 9 - 10 - 15
Prijs	€	16,90

TENGOOLS



Individuele mini-schroevendraaiers voor MDM706 en MDM706TX.

Order nr.	Orig. nr.	Plat mm	Maat PH	Maat Hex mm	Maat TX	Prijs €
68940139	MDM711			2		4,20
68940162	MDM712			2,5		4,20
68940204	MDM713	2				4,20
68940303	MDM714	2,4				4,20
68940402	MDM715	3				4,20
68940501	MDM716		00			4,20
68940600	MDM717		0			4,20
68940709	MDM718		1			4,20
102151008	MDM806				6	4,20
102151107	MDM807				7	4,20
102151206	MDM808				8	4,20
102151305	MDM809				9	4,20
102151404	MDM810				10	4,20
102151503	MDM815				15	4,20

TOOLS

TENGOOLS

NEW



Schroevendraaier met schacht in TT-MV PLUS Staal met clip

Order nr.	199680307
Orig. nr.	MDMC702N
Plat mm	3
Maat PH	1
Aantal stuks	2
Prijs €	10,20

TENGOOLS

NEW



Schroevendraaier met schacht in TT-MV PLUS Staal

Order nr.	199680208
Orig. nr.	MDMC715N
Maat PH	1
Prijs €	5,00

TENGOOLS

NEW



Schroevendraaier met schacht in TT-MV PLUS Staal

Order nr.	199680109
Orig. nr.	MDMC718N
Plat mm	3
Prijs €	5,00

TENGOOLS



Flexibele schroevendraaier met 1/4" aansluiting voor doppen.

Order nr.	199910308
Orig. nr.	MD514N
Aansluiting	inch 1/4
Prijs €	10,60

TENGOOLS



Schroevendraaier "Stubby" voor PZ sleufkop. Ronde schacht uit TT-MV PLUS staal. Zwarte tip. Ergonomisch twee-componenten handvat met ophanggat.

Order nr.	177780400	177780806
Orig. nr.	MD961N2	MD962N3
Lengte schacht	mm 38	38
Lengte handvat	mm 58	58
Tip	PZ1	PZ2
Prijs €	5,50	5,20

TENGOOLS



Schroevendraaier "Stubby" voor PH sleufkop. Ronde schacht uit TT-MV PLUS staal. Zwarte tip. Ergonomisch twee-componenten handvat met ophanggat. DIN 5260.

Order nr.	177770302	177770609
Orig. nr.	MD947N	MD948N
Lengte schacht	mm 38	38
Lengte handvat	mm 58	58
Tip	PH1	PH2
Prijs €	5,20	5,20

TENGOOLS



Compacte bitsen schroevendraaier voor 1/4" bitsen, met magneet die zowel de bits als de schroef vasthoudt. Twee componenten handvat met ophanggat.

Order nr.	185840105
Orig. nr.	MDBH
Prijs €	6,30

TENGOOLS



Compacte bitsen schroevendraaier met 8 bitsen 1/4 hex, L=25 mm.

Order nr.	185920105
Orig. nr.	MD908N
Bitsen plat	mm 6.5 - 8.0
Bitsen PH	1 - 2
Bitsen PZ	1 - 2
Bitsen Hex	mm 4 - 5
Prijs €	8,50

TENGOOLS



Schroevendraaier met 1/4"-opnamedop. Met ingebouwde magneet die zowel de bits als de schroef vasthoudt. Kunststof handvat met opbergruimte voor bitsen. Geleverd met 6 bitsen: 2 Platte, 2 Phillips en 2 Pozidriv.

Order nr.	72570104 †	
Orig. nr.	MD907	
Lengte schacht	mm	100
Lengte handvat	mm	120
Bitsen	Plat 1,2x5mm - Plat 1,4x7mm - PH1 - PH2 - PZ1 - PZ2	
Prijs	€	14,40

TENGOOLS



Schroevendraaier met 1/4"-opnamedop. Met ingebouwde magneet die zowel de bits als de schroef vasthoudt. Kunststof handvat met opbergruimte voor bitsen. Geleverd met 6 torx bitsen.

Order nr.	101910107 †	
Orig. nr.	MD907TX	
Lengte schacht	mm	100
Lengte handvat	mm	120
Bitsen TX	10 - 15 - 20 - 25 - 27 - 30	
Prijs	€	16,20

TENGOOLS



Stubby bitsratel schroevendraaier voor 1/4" bitsen. Met magneet dat zowel de bits als de schroef vasthoudt. Twee-componentenhandvat. Incl. 6 bits en adaptor, opgeborgen in het handvat.

Order nr.	186550109 †	
Orig. nr.	MDR908S	
Bitsen plat	mm	5,7
Bitsen PH	1-2	
Bitsen PZ	1-2	
Adaptor	1/4"	
Aansluiting	inch	1/4"
Prijs	€	15,50

TENGOOLS



Bitsenratel voor 1/4" bitsen, met magneet voor het vasthouden van de bits en de schroef. Twee componenten handvat met ophanggat. Inclusief 6 bitsen en een adaptor opgeslagen in het handvat.

Order nr.	186560108 †	
Orig. nr.	MDR908	
Bitsen plat	mm	5,7
Bitsen PH	1-2	
Bitsen PZ	1-2	
Adaptor	1/4"	
Aansluiting	inch	1/4"
Prijs	€	15,50

TENGOOLS



Set. TC-tray.

Bestaande uit:

- 11 lange dubbelzijdige bitsen Plat, PH en PZ
- een ergonomisch zwart-rood twee componenten handvat

Order nr.	128650108 †	
Orig. nr.	TTMD12D	
Schacht PH	1x2 - 1x6,5	
Schacht Plat	mm	4,0x5,5
Schacht PZ	1x2	
Schacht TX	10x15 - 20x25 - 30x40	
Maat Hex	mm	3x3 met bolkop, 4x4 met bolkop, 5x5 met bolkop, 6x6 met bolkop
Prijs	€	32,50

TENGOOLS



Wisselstukken voor de set TTMD12D.

Order nr.	Orig. nr.	Omschrijving	Prijs €
128650207 †	MD901	handvat	7,80
128650306 †	PHH0102	lange bits PH1xPH2	5,30
128650405 †	FTF4055	lange bits 4,0x5,5	5,00
128650603 †	PZZ0102	lange bits PZ1xPZ2	5,30
128650702 †	TXX1015	lange bits TX10xTX15	5,00
128650801 †	TXX2025	lange bits TX20xTX25	5,00
128650900 †	TXX3040	lange bits TX30xTX40	5,00
128651007 †	HBH0303	lange bits (hex)-3x3mm bolkop	7,30
128651106 †	HBH0404	lange bits (hex)-4x4mm bolkop	7,30
128651205 †	HDH0505	lange bits (hex)-5x5mm bolkop	7,30
128651304 †	HBH0606	lange bits (hex)-6x6mm bolkop	7,30
128650504 †	PHF0365	lange bits PH3x6,5mm plat	5,30

TENGOOLS



Momentschroevendraaier met accessoires in set.

Bestaande uit:

- 1 momentschroevendraaier 1/4" Cap 1-5Nm
- 1 bitshouder 1/4" - 1/4" hex

Order nr.	122060106	
Orig. nr.	1492SD	
Bereik ISO	Nm	1-5
Doppen	inch	hex 1/4
Nauwkeurigheid	mm	+/-6%
Prijs	€	65,50

TENGOOLS



Momentschroevendraaier voor precisie aanspannen van moeren en bouten. Met 1/4" vierkante aansluiting en een adaptor voor 1/4" zeskante bitsen.

Geschikt voor o.a. fijne mechanica, elektronica,... Geleverd met een 1/4" T-handvat.

Order nr.	172300105	
Orig. nr.	1492SDA	
Bereik ISO	Nm	2-8
Bereik	lbs.in	20-70
Lengte	mm	160
Doppen	inch	hex 1/4
Nauwkeurigheid	mm	+/-6%
Prijs	€	70,50

TENGOOLS



NEW

Bitshouder en bitsen. Twee componenten handvat met ruimte voor 7 dubbele bitsen 32 mm.

Order nr.	231600107	
Orig. nr.	MDR915	
Bitsen	plat 4mm, plat 6mm, PH0 x PH3, PH1 x PH2, PZO x PZ3, PZ1 x PZ2, TX10 x TX15, TX20 x TX25	
Prijs	€	22,20

TENGOOLS



39-delige set.

Bestaande uit:

- 1 moment schroevendraaier 1/4"
- 1 verlengstuk L. 100mm
- 1 bitshouder 1/4"
- 36 verschillende bits.

Nauwkeurigheid +/- 6%.

Order nr.	122500101	
Orig. nr.	TTSD39	
Bitsen	Plat 0,5x3mm - Plat 0,6x4,5mm - Plat 0,8x5,5mm - Plat 1,2x6,5mm - PH0 - PH1 - PH2 - PH3 - PZO - PZ1 - PZ2 - PZ3 - TX8 - TX9 - TX10 - TX15 - TX20 - TX25 - TX27 - TX30 - TX40 - TPX10 - TPX15 - TPX20 - TPX30 - TPX40 - Rob 0 - Rob 1 - Rob 2 - Rob 3 - PH GR 2(2) - Hex 2mm - Hex 3mm - Hex 4mm - Hex 5mm - Hex 6mm	
Momentschroevendraaier 1/4"-Hex voor	Nm	1-5
Prijs	€	91,50

TOOLS



3 in 1. Electronica microset 47 dlg.

Kenmerken:

- Ideaal voor alle vakmannen voor elektronica, fabricage van juwelen en optica.
- Bestaat uit 3 kleine sets met elk een handvat.

Order nr.	801000090	
Orig. nr.	PB47	
Aantal stuks	47	
Bitsen plat	mm	0,6 - 0,8 - 1,0 - 1,2 - 1,4 - 1,5(x2) - 1,6 - 1,7 - 1,8 - 2,0(x3) - 2,2 - 2,5(x2) - 3,0 - 4,0
Bitsen PH	000 - 00 - 0 - 1,0 - 1,5 - 2,0(x2) - 2,5	
Bitsen TX	5(x2) - 6(x2) - 7(x2) - 8(x2) - 9(x2) - 10(x2) - 15 - 20	
Bitsen Triangle	3,0	
Bitsen Y	3,5	
Bitsen Star	1,6	
Bitsen SP	2	
Prijs	€	34,90

Schroevendraaiers 1000V

TENGTOOLS



Set van 6 platte en PH schroevendraaiers. Schacht bedekt met 2 lagen in verschillende kleuren. Met geïsoleerde handgreep en schacht. Conform EN 60900 voor werk onder voltage tot 1000V (door gekwalificeerde elektriciërs). Geleverd in een kunstof tray.

Order nr.	178200309
Orig. nr.	MDV906N
Schroevendraaiers Plat	mm 0,4x2,5x75 - 0,5x3,0x100 - 0,8x4,0x100 - 1,0x5,5x125
Schroevendraaiers PH	mm 1(x80) - 2(x100)
Prijs	€ 22,90

TENGTOOLS



Set van 7 1000V-schroevendraaiers plat, PZ en PH in Teng TC tray.

Bestaande uit:

- 3 platte schroevendraaiers
- 3 PH Schroevendraaiers
- 1 PZ schroevendraaier.

Kenmerken:

- Met geïsoleerde handgreep en schacht.
- TC-tray.

Order nr.	178710109
Orig. nr.	TTV907N
Schroevendraaiers Plat	mm 2,5x75 - 4x100 - 5,5x125
Schroevendraaiers PH	mm 0(x60) - 1(x80) - 2(x100)
Schroevendraaiers PZ	(mm) 2(x100)
Afmetingen (l x b x h)	mm 265 x 142 x 50
Prijs	€ 29,50

TENGTOOLS

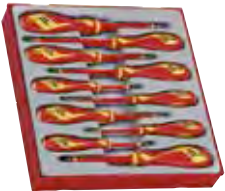

Set van 10 schroevendraaiers 1000-V plat, PH en PZ in TTD tray.

Order nr.	174390104
Orig. nr.	TTDV910N
Schroevendraaiers Plat	mm 0,4x2,5x75 - 0,5x3,0x100 - 0,8x4,0x100 - 1,0x5,5x125
Schroevendraaiers PH	0 - 1 - 2
Schroevendraaiers PZ	0 - 1 - 2
Afmetingen (l x b x h)	mm 265 x 142 x 50
Prijs	€ 41,50

TENGTOOLS

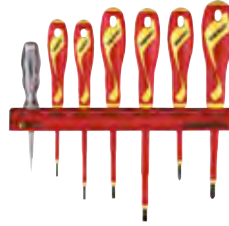

Schroevendraaiersset 7dlg 1000V op muurrek.

Order nr.	174520205
Orig. nr.	WRMDV07N
Schroevendraaiers Plat	mm 0,4x2,5x75mm, 0,5x3,0x100mm, 0,8x4,0x100mm, 1,0x5,5x125mm
Schroevendraaiers PH	mm PH1x80mm, PH2x100mm
Voltage tester	100V-250V
Prijs	€ 27,90

TENGTOOLS



Schroevendraaiersset 5dlg 1000V op muurrek.

Order nr.	174520106
Orig. nr.	WRMDV05N
Maat PH	0x75 - 1x75
Maat PZ	1x75
Schroevendraaiers Plat	mm 0,5x3,0x100 - 1,0x5,5x75
Prijs	€ 29,90

TENGTOOLS



Geïsoleerde schroevendraaier. Zwarte tip. Met ophanggat.

Order nr.	Orig. nr.	Maat plat mm	Lengte schacht mm	Lengte handvat mm	Handvat type	Prijs €
177870102	MDV820N	0,4x2,5	75	175		5,60
177870201	MDV822N	0,5x3,0	100	96	B	5,60
177870250	MDV823N	0,6x3,5	100			5,50
177870300	MDV824N	0,8x4,0	100	108	C	6,60
177870409	MDV826N	1,0x5,5	125	108	C	7,60
177870508	MDV828N	1,2x6,5	150	116	D	9,60

TENGTOOLS



Geïsoleerde schroevendraaier. Zwarte tip. Ergonomisch twee-componenten handvat met ophanggat.

Order nr.	Orig. nr.	Lengte schacht mm	Lengte handvat mm	Handvat type	Maat PH	Prijs €
177880101	MDV840N	60	96	B	0	5,60
177880200	MDV842N	80	108	C	1	7,10
177880309	MDV844N	100	225	D	2	9,20
177880408	MDV846N	150	290	E	3	12,20

TENGOOLS



Geïsoleerde schroevendraaier. Zwarte tip. Ergonomisch twee-componenten handvat met ophanggat.

Order nr.	Orig. nr.	Lengte schacht mm	Lengte handvat mm	Maat PZ	Handvat type	Prijs €
177890100	MDV860N	60	96	0	B	6,40
177890209	MDV862N	80	108	1	C	7,10
177890308	MDV864N	100	116	2	D	9,20
177890407	MDV866N	150	125	3	E	13,30

TENGOOLS



NEW

Geïsoleerde schroevendraaier voor vierkante koppen zoals Robertson type. Schacht bedekt met 2 lagen in verschillende kleuren. Met geïsoleerde handgreep en schacht. Conform EN 60900 voor werk onder voltage tot 1000 V.

Order nr.	186590105
Orig. nr.	MDV802N
Lengte schacht mm	100
Maat Rob	2
Handvat type	D
Handvat lengte mm	116
Prijs €	8,10

TENGOOLS



NEW

Geïsoleerde schroevendraaier voor plus-min schroeven (Phillips/plat of Pozidriv/plat). Schacht bedekt met 2 lagen in verschillende kleuren. Met geïsoleerde handgreep en schacht. Conform EN 60900 voor werk onder voltage tot 1000 V.

Order nr.	186590204	186590303
Orig. nr.	MDV844NF	MDV864NF
Lengte schacht mm	100	100
Handvat type	D	D
Handvat lengte mm	116	116
Maat	plat/PH2	plat/PZ2
Prijs €	8,90	8,90

TENGOOLS



Geïsoleerde spanningstester voor 100-250V.

Order nr.	186610101
Orig. nr.	MDV9855
Lengte schacht mm	70
Lengte handvat mm	75
Prijs €	5,00

Bitsen

TENGOOLS



Bitset 1/4" met magnetische bitshouder. Verpakt in een typische mini-Tengbox.

Order nr.	102610102	102630100
Orig. nr.	BBX07A	BBX07TXA
Aantal stuks	7	7
Bitsen 1/4" plat mm	1,0x5,5 - 1,2x6,5	
Bitsen 1/4" PH	1 - 2	
Bitsen 1/4" PZ	1 - 2	
Bitsen 1/4" TX		10 - 15 - 20 - 25 - 30 - 40
Prijs €	10,80	11,70

TENGOOLS



Set van 27 van de meeste gebruikte bitsen. L.25mm 1/4" met bitshouder. Verpakt in een typische mini-Tengbox.

Order nr.	172390106
Orig. nr.	TM028
Aantal stuks	28
Bitsen 1/4" plat mm	0,6x4 - 0,8x5,5 - 1x6,5
Bitsen 1/4" PH	1 - 2 - 3
Bitsen 1/4" PZ	1 - 2 - 3
Bitsen 1/4" TX	10 - 15 - 20 - 25 - 30 - 40
Bitsen 1/4" Rob	1 - 2 - 3
Bitsen 1/4" Hex mm	4 - 5 - 6
Bitsen 1/4" GR	2 (x2)
Bitsen 1/4" TPX	20 - 25 - 30
Adaptor Hex 1/4" inch	1/4
Prijs €	15,50

TENGOOLS



29-delige mini bitsset 1/4". Bestaande uit 1 mini-handratel 1/4", 1 bitshouder en 27 bitsen. Geleverd in een kunststof doos met klikslot.

Order nr.	167360106
Orig. nr.	TM029
Aantal stuks	29
Bitsen plat mm	4,5 - 5,5 - 6,5
Bitsen PH	1 - 2 - 3
Bitsen PZ	1 - 2 - 3
Bitsen TX	10 - 15 - 20 - 25 - 30 - 40
Bitsen TPX	20 - 25 - 30
Bitsen Rob	1 - 2 - 3
Bitsen Hex mm	4 - 5 - 6
Bitsen GR	2 (x2)
Accessoires 1/4" aansluiting	bitshouder 50mm - bitsratel 8mm - hex adaptor M/F
Prijs €	28,50

TENGOOLS



Set van 7 lange bitsen. L.120mm 1/4" plat, PH en TX en een bitshandvat. Bitsen zijn 2-zijdig bruikbaar. Geleverd in een handige mini-Teng box.

Order nr.	172280109
Orig. nr.	TM708
Schroevendraaiers	Plat 2,0mm x PH00 - Plat 3,0mm x PH0 - Plat 4,0mm x PH1 - PZ0xPZ1 - TX5xTX7 - TX6xTX8 - TX9xTX10
Prijs	€ 16,50

TENGOOLS

Individuele accessoires uit de set TM708.

Order nr.	Orig. nr.	Omschrijving	Prijs €
118120203	MDM700	Handvat	4,20
118120302	2912512	combi-schacht 0,3x2,0 - PH00	3,80
118120401	2912513	combi-schacht 0,4x3,0 - PH0	3,80
118120500	2912514	combi-schacht 0,5x4,0 - PH1	3,80
118120609	2912520	combi-schacht PZ0-PZ1	3,80
118120708	2912535	combi-schacht TX5 - TX7	3,80
118120807	2912537	combi-schacht TX6 - TX8	3,80
118120906	2912539	combi-schacht TX9 - TX10	3,80

TENGOOLS



74 delige set. TC-tray.

Bevat:

- Ratel bit schroevendraaier
- 6" flexibel verlengstuk
- 4" verlengstuk
- 1/4" M x 1/4" hex adaptor
- koppel adaptor
- 69 bitsen

Order nr.	144030103
Orig. nr.	TTMD74
Bitsen 1/4" Hex aansluiting 25mm plat	mm 0,6x3,5 - 0,6x4,5 - 0,8x4 - 0,8x5,5 - 1x5,5 - 1,2x5 - 1,2x6,5 - 1,4x7 - 1,6x8
Bitsen 1/4" Hex aansluiting 25mm PH	1 (x4) - 2(x7) - 3
Bitsen 1/4" Hex aansluiting 25mm PZ	1 (x4) - 2(x7) - 3
Bitsen 1/4" Hex aansluiting 25mm TX	6 - 7 - 8 - 9 - 10 - 15 - 20 (x3) - 25 (x3) - 27 - 30 - 40
Bitsen 1/4" Hex aansluiting 25mm TPX	10 - 15 - 20 (x2) - 25 (x2) - 27 - 30 - 40
Bitsen 1/4" Hex aansluiting 25mm Hex	mm 2 - 3 - 4 - 5 - 6 - 8
Bitsen 1/4" Hex aansluiting 25mm SQ	1 - 2 - 3
Bitsen 1/4" Hex aansluiting 25mm GR	2 (x3)
Prijs	€ 37,50

TENGOOLS



Flexibel verlengstuk uit TTMD74

Order nr.	144030301
Orig. nr.	TTMD74-2
Aansluiting	inch 1/4
Lengte	mm 150
Prijs	€ 3,00

TENGOOLS



Ratel bit schroevendraaier 1/4".
64 delige set in een TC tray met
afneembaar deksel.

Bevat:

- Ratel bit schroevendraaier met plooibaar handvat
- 11 doppen 1/4"
- 52 bitsen

Order nr.	237720107
Orig. nr.	TTMDRT64
Aantal stuks	64
Bitsen 1/4" plat	mm 0,6x3,5-0,6x4,5-0,8x4,0-0,8x5,0-0,8x5,5- 1,0x5,5-1,2x6,5-1,2x7,0-1,6x8,0
Bitsen 1/4" PH	PH1x4-PH2x4-PH3x2
Bitsen 1/4" PZ	PZ1-PZ2x3-PZ3x2
Bitsen 1/4" TX	TX6-TX7-TX8-TX9-TX10-TX15-TX20x3-TX25x3- TX27-TX30-TX40
Bitsen 1/4" Rob	S1-S2S3
Bitsen 1/4" Hex	hex2-hex3-hex4x3-hex5-hex6-hex8
Doppen 1/4"	mm 4-5-5,5-6-7-8-9-10-11-12-13
Adapter	inch 1/4
Prijs	€ 40,80

TENGOOLS



Schroevendraaier voor slangklemmen. Met flexibele schacht voor een goede toegankelijkheid. Met omwisselbare dop van 6 en 7mm. Totale lengte 275mm.

Order nr.	199910100
Orig. nr.	MD503N
Capaciteit	mm 6-7
Lengte	mm 275
Prijs	€ 13,30

TENGOOLS



Schroevendraaier voor slangklemmen. Totale lengte 275mm.

Kenmerken:

- Met flexibele schacht voor een goede toegankelijkheid.
- Met dop van 7mm.

Order nr.	199910209
Orig. nr.	MD503NA
Capaciteit	mm 7
Lengte	mm 275
Prijs	€ 10,30

TENGOOLS



Schroevendraaier voor slangklemmen. Totale lengte 275mm.

Kenmerken:

- Met flexibele schacht voor een goede toegankelijkheid.
- Met dop van 8mm.

Order nr.	199640103
Orig. nr.	MD503ND
Capaciteit	mm 8
Lengte	mm 275
Prijs	€ 10,50

Schroevendraaiers & bitsen

TENGOOLS



Bi-ervangdop 6 en 7mm voor MD503.

Order nr.	61180207
Orig. nr.	MD503RK
Prijs	€ 1,30

TENGOOLS



Mini bitsratel 1/4" L.90mm met aan de andere sleutelzijde een 8mm ringopname.

Kenmerken:

- Chroom-vanadium.
- Verchromde uitvoering.

Order nr.	118340108
Orig. nr.	1400B
Lengte	mm 90
Prijs	€ 24,00

TENGOOLS



Schroevendraaier met 1/4"-opnamedop, met ingebouwde magneet die zowel de bits als de schroef vasthoudt. Zeskant chroom vanadium schacht. Kunststof handvat met ophang-opening.

Order nr.	100240100
Orig. nr.	MD900
Lengte schacht	mm 100
Lengte handvat	mm 120
Prijs	€ 10,40

TENGOOLS



Bitshouder met snelspanbitshouder. Met 1/4" hex-aansluiting. Lengte 50mm.

Order nr.	106170103
Orig. nr.	ACC50CBH01
Prijs	€ 10,20

TENGOOLS



Bitshouder met verzonken magneet. Met 1/4" hex-aansluiting.

Order nr.	106160104	106160203
Orig. nr.	ACC50MBH01	ACC70MBH01
Lengte	mm 50	70
Prijs	€ 4,00	5,20

TENGOOLS



Adaptor met 1/4" hex en vierkant aansluitingen. Voor gebruik met standaard slagdoppen ed. Voor gebruik met machines met 1/4" hex-aandrijving. Lengte 50mm.

Order nr.	Orig. nr.	Aansluiting inch	Prijs €
106180102	ACCSDA1414	1/4	7,40
106180201	ACCSDA1438	3/8	11,90
106180300	ACCSDA1412	1/2	15,10

TENGOOLS



Magnetische bitshouder met verzonken magneet met hex-aansluiting. Voor gebruik in elektrische boormachines. Lengte 45mm.

Order nr.	Orig. nr.	Maat inch	Maat mm	Type	Prijs €
111730107	NS45108M	1/4		magnetisch	2,80
111730305	NS45506M		6	magnetisch	2,80
111730503	NS4508M		8	magnetisch	3,20
111730354	NS4507M		7	magnetisch	3,00
111730602	NS4508R		8	ring	3,00

TENGOOLS



Bits. Plat type. L.25 of 70mm met 1/4" Hex-aandrijving. VE = verpakkingseenheid

Order nr.	Orig. nr.	Maat PH	Type	Lengte mm	Maat plat mm	VE	Prijs/VE €
106041007	FL2506A10		plat	25	0,6x3,5	10	5,10
106040108	FL2506A03		plat	25	0,6x3,5	3	2,60
106040207	FL2506B03		plat	25	0,6x4,5	3	2,60
106040306	FL2508A03		plat	25	0,6x4,5	3	2,60
106040405	FL2508B03		plat	25	0,8x5,5	3	2,60
106040504	FL2510A03		plat	25	1,0x5,5	3	2,60
106040702	FL2516A03		plat	25	1,6x8,0	3	3,70
106041403	FL2510A10		plat	25	1,0x5,5	10	5,10
106041601	FL2516A10		plat	25	1,6x8,0	10	8,30
106041106	FL2506B10		plat	25	0,6x4,5	10	5,10
106041205	FL2508A10		plat	25	0,8x4	10	5,10
106040603	FL2512A03		plat	25	1,2x6,5	3	2,60
106051006	FL7006A02		plat	70	0,6x3,5	2	3,70
106051204	FL7008B02		plat	70	0,8x5,5	2	3,70
106050107	FL5006A03		plat	-	0,6x3,5	3	3,70
106050206	FL5008A03		plat	-	0,8x4,0	3	3,70
106050305	FL5008B03		plat	-	0,8x5,5	3	3,70
106050404	FL5010A03		plat	-	1,0x5,5	3	3,70
106050503	FL5012A03		plat	-	1,2x6,5	3	3,70
106051105	FL7008A02		plat	-	0,8x4,0	2	3,70
106051303	FL7010A02		plat	-	1,0x5,5	2	3,70
106280100	GR25002010	2	PH	25		10	10,70
106281009	GR25002100	2	PH	25		100	40,70

TENGOOLS



Bits. Phillips type. L.25mm met 1/4" Hex-aandrijving. VE = verpakkingseenheid.

Order nr.	Orig. nr.	Maat PH	Type	VE	Prijs/VE €
106060106	PH2500103	1	PH	3	3,10
106060403	PH2500110	1	PH	10	6,10
106060205	PH2500203	2	PH	3	3,20
106060502	PH2500210	2	PH	10	6,10
106060304	PH2500303	3	PH	3	3,10
106060601	PH2500310	3	PH	10	6,10

TENGOOLS



Bits. Hex type. L.25mm. Beschikt over 1/4" Hex-aandrijving. VE = verpakkingseenheid.

Order nr.	Orig. nr.	Type	Maat Hex mm	VE	Prijs/VE €
106100100	HEX2500203	Hex	2	3	2,60
106100209	HEX2500303	Hex	3	3	2,60
106100308	HEX2500403	Hex	4	3	2,60
106100407	HEX2500503	Hex	5	3	2,60
106100506	HEX2500603	Hex	6	3	2,60
106100605	HEX2500803	Hex	8	3	3,30

TENGOOLS



Lange bits. Phillips type. L.50mm met 1/4" Hex-aandrijving. VE = verpakkingseenheid.

Order nr.	Orig. nr.	Maat PH	Type	VE	Prijs/VE €
106070105	PH5000103	1	PH	3	4,40
106070204	PH5000203	2	PH	3	4,40
106070303	PH5000303	3	PH	3	4,40

TENGOOLS



Extra-lange bits. Phillips type. L.70mm met 1/4" Hex-aandrijving. VE = verpakkingseenheid.

Order nr.	Orig. nr.	Maat PH	Type	VE	Prijs/VE €
106070402	PH7000102	1	PH	2	4,40
106070501	PH7000202	2	PH	2	4,40

TENGOOLS



Bits. Pozidriv type. L.25mm met 1/4" Hex-aandrijving. VE = verpakkingseenheid.

Order nr.	Orig. nr.	Type	Lengte mm	Maat PZ	VE	Prijs/VE €
106080104	PZ2500103	PZ	25	1	3	3,10
106081003	PZ2500110	PZ	25	1	10	6,10
106080203	PZ2500203	PZ	25	2	3	3,20
106081102	PZ2500210	PZ	25	2	10	6,40
106080302	PZ2500303	PZ	25	3	3	3,10
106081201	PZ2500310	PZ	25	3	10	6,10

TENGOOLS



Lange bits. Pozidriv type. L.50mm met 1/4" Hex-aandrijving. VE = verpakkingseenheid.

Order nr.	Orig. nr.	Type	Maat PZ	VE	Prijs/VE €
106090103	PZ5000103	PZ	1	3	4,40
106090202	PZ5000203	PZ	2	3	4,40
106090301	PZ5000303	PZ	3	3	4,40

TENGOOLS



Extra-lange bits. Pozidriv type. L.70mm met 1/4" Hex-aandrijving. VE = verpakkingseenheid.

Order nr.	Orig. nr.	Type	Maat PZ	VE	Prijs/VE €
106090400	PZ7000102	PZ	1	2	4,40
106090509	PZ7000202	PZ	2	2	4,40

TENGOOLS



Bits. Hex type. L.40mm met ofwel 10mm Hex ofwel 12mm Hex-aandrijving.

Order nr.	Orig. nr.	Type	Maat Hex mm	Aansluiting Hex mm	Prijs €
101860104	210705	Hex	5	10	2,20
101860203	210706	Hex	6	10	2,20
101860302	210707	Hex	7	10	2,20
101860401	210708	Hex	8	10	2,20
101860500	210709	Hex	9	10	2,20
101860609	210710	Hex	10	10	2,20
101860708	210712	Hex	12	12	2,50
101860807	210714	Hex	14	12	3,30
101860906	210717	Hex	17	12	4,80
101861003	210719	Hex	19	12	5,70

TENGOOLS



Lange bits. Hex type. L.75mm met ofwel 10mm Hex ofwel 12mm Hex-aandrijving.

Order nr.	Orig. nr.	Type	Maat Hex mm	Aansluiting Hex mm	Prijs €
101880102	210805	Hex	5	10	3,30
101880201	210806	Hex	6	10	3,30
101880300	210807	Hex	7	10	3,30
101880409	210808	Hex	8	10	3,30
101880508	210809	Hex	9	10	3,30
101880607	210810	Hex	10	10	3,30
101880706	210812	Hex	12	12	3,50
101880805	210814	Hex	14	12	5,50
101880904	210817	Hex	17	12	7,80
101881001	210819	Hex	19	12	9,20

TENGOOLS



Lange bits. Hex type. L.50mm met 1/4" Hex-aandrijving. VE = verpakkingseenheid.

Order nr.	Orig. nr.	Type	Maat Hex mm	VE	Prijs/VE €
106110109	HEX5000403	Hex	4	3	3,70
106110208	HEX5000503	Hex	5	3	3,70
106110307	HEX5000603	Hex	6	3	3,70
106110406	HEX5000803	Hex	8	3	5,90

TENGOOLS



Bits. TX type. L.25mm met 1/4" Hex-aandrijving. VE = verpakkingseenheid.

Order nr.	Orig. nr.	Type	Maat TX	VE	Prijs/VE €
106120108	TX2500603	TX	6	3	3,30
106120207	TX2500703	TX	7	3	3,30
106120306	TX2500803	TX	8	3	3,30
106120405	TX2500903	TX	9	3	3,30
106120504	TX2501003	TX	10	3	3,30
106120603	TX2501503	TX	15	3	3,30
106120702	TX2502003	TX	20	3	3,30
106120801	TX2502503	TX	25	3	3,30
106120900	TX2502703	TX	27	3	3,30
106121007	TX2503003	TX	30	3	3,30
106121106	TX2504003	TX	40	3	3,30
106122005	TX2500610	TX	6	10	6,60
106122104	TX2500710	TX	7	10	6,60
106122203	TX2500810	TX	8	10	6,60
106122302	TX2500910	TX	9	10	6,60
106122401	TX2501010	TX	10	10	6,60
106122500	TX2501510	TX	15	10	6,60
106122807	TX2502710	TX	27	10	6,60

TENGOOLS



Bits. TX type. L.25mm met 1/4" Hex-aandrijving. VE = verpakkingseenheid.

Order nr.	Orig. nr.	Type	Maat TX	VE	Prijs/VE €
109690107	TX2501501B	TX	15	100	55,70
109690206	TX2502001B	TX	20	100	55,70
109690305	TX2502501B	TX	25	100	55,70
109690404	TX2503001B	TX	30	100	55,70
109690503	TX2504001B	TX	40	100	55,70

TENGTOLS



Lange bits. TX type. L.70mm met 1/4" Hex-aandrijving.

Order nr.	Orig. nr.	Type	Lengte mm	Maat TX	VE	Prijs/VE €
106130107	TX500803	TX	50	8	3	4,40
106130206	TX5001003	TX	50	10	3	4,40
106130305	TX5001503	TX	50	15	3	4,40
106130404	TX5002003	TX	50	20	3	4,40
106130503	TX5002503	TX	50	25	3	4,40
106130602	TX5002703	TX	50	27	3	4,40
106130701	TX5003003	TX	50	30	3	4,40
106130800	TX7001002	TX	50	10	2	4,40
106130909	TX7001502	TX	70	15	2	7,10
106131006	TX7002002	TX	70	20	2	7,10
106131105	TX7002502	TX	70	25	2	7,10

TENGTOLS



Bits. TX type. L.40mm met ofwel 10mm Hex ofwel 12mm Hex-aandrijving.

Order nr.	Orig. nr.	Type	Maat TX	Aansluiting Hex	Prijs €
101870103	220720	TX	20	10	2,20
101870202	220725	TX	25	10	2,20
101870301	220727	TX	27	10	2,20
101870400	220730	TX	30	10	2,30
101870509	220740	TX	40	10	2,30
101870608	220745	TX	45	10	2,30
101870707	220750	TX	50	10	2,20
101870806	220755	TX	55	10	2,20
101870905	220760		60	12	2,60
101871002	220770	TX	70	12	3,70

TENGTOLS



Lange bits. TX type. L.75mm met ofwel 10mm Hex ofwel 12mm Hex-aandrijving.

Order nr.	Orig. nr.	Type	Maat TX	Aansluiting Hex	Prijs €
101890101	220820	TX	20	10	3,30
101890200	220825	TX	25	10	3,30
101890309	220827	TX	27	10	3,30
101890408	220830	TX	30	10	3,30
101890507	220840	TX	40	10	3,50
101890606	220845	TX	45	10	3,30
101890705	220850	TX	50	10	3,30
101890804	220855	TX	55	10	3,30
101890903	220860	TX	60	12	3,70
101891000	220870	TX	70	12	5,90

TENGTOLS



Bits. Rob - vierkant type. L.25mm met 1/4" Hex-aandrijving. VE = verpakkingseenheid.

Order nr.	Orig. nr.	Type	Maat Rob	VE	Prijs/VE €
106150105	ROB2500103	ROB	1	3	3,30
106150204	ROB2500203	ROB	2	3	3,30
106150303	ROB2500303	ROB	3	3	3,30

TENGTOLS



Bits. TPX type. L.25mm met 1/4" Hex-aandrijving. VE = verpakkingseenheid.

Order nr.	Orig. nr.	Type	Maat TPX	VE	Prijs/VE €
106140106	TPX2501003	TPX	10	3	4,10
106140205	TPX2501503	TPX	15	3	4,10
106140304	TPX2502003	TPX	20	3	4,10
106140403	TPX2502503	TPX	25	3	4,10
106140502	TPX2502703	TPX	27	3	4,10
106140601	TPX2503003	TPX	30	3	4,10
106140700	TPX2504003	TPX	40	3	4,10
106141005	TPX2501010	TPX	10	10	9,30
106141104	TPX2501510	TPX	15	10	9,30
106141203	TPX2502010	TPX	20	10	9,30
106141401	TPX2502710	TPX	27	10	9,30
106141500	TPX2503010	TPX	30	10	9,30
106141609	TPX2504010	TPX	40	10	9,30

TENGTOLS



NEW

6 delige schroevendraaiersset TX met T-hendel. Geleverd met houder voor wandmontage.

Order nr.	237730106				
Orig. nr.	MDM706TXT				
Schroevendraaiers TX	mm	TX6-TX7-TX8-TX9-TX10-TX15			
Prijs	€	12,60			

TENGTOLS



NEW

Aparte TX schroevendraaiers van de set MDM706TXT. Met T-hendel.

Order nr.	Orig. nr.	Maat	Prijs €
237740105	MDM806T	TX6	3,70
237740204	MDM807T	TX7	3,70
237740303	MDM808T	TX8	3,70
237740402	MDM809T	TX9	3,70
237740501	MDM810T	TX10	3,70
237740600	MDM815T	TX15	3,70

TENGTOLS



NEW

Dubbele bitsen. 5 stuks.

Order nr.	Orig. nr.	Aantal stuks	Bitsen plat mm	Bitsen PH	Bitsen PZ	Bitsen TX	Lengte mm	Prijs €
231610106	FTF32406005	5	0,8x4-1,2x6				32	5,20
231610205	PHH32000305	5		PH0 - PH3			32	6,10
231610304	PHH32010205	5		PH1 - PH2			32	6,10
231610403	PZZ32000305	5			PZ0 - PZ3		32	6,10
231610502	PZZ32010205	5			PZ1 - PZ2		32	6,10
231610601	TXX32101505	5				TX10 - TX15	32	6,10
231610700	TXX32202505	5				TX20 - TX25	32	6,10

TOOLS

90°



Haakse boorhouder. Met deze boorhouder boort u in de kleinste hoekjes. Geleverd met een zelfspannende boormachine cap. 0-10mm. Boormachine zijde met 5/16" opname. Japans kwaliteitsproduct.

Order nr.	728540090	
Orig. nr.	PRO90	
Maximum koppel	Nm	53
Aansluiting boormachine	mm	8
Prijs	€	67,90

TOOLS



90°

LED

KORTE KOP



Haakse bitshouder. Met deze bitshouder bereikt u de meeste onmogelijke hoekjes. Voor alle gangbare bitsen met 1/4" hex-opname. Boormachine zijde eveneens 1/4" hex-opname. Japans kwaliteitsproduct.

Order nr.	728541017	
Orig. nr.	PRO75+LED	
Maximum koppel	Nm	75
Prijs	€	84,90

TOOLS



90°

KORTE KOP



Haakse bitshouder. Met deze bitshouder bereikt u de meeste onmogelijke hoekjes. Voor alle gangbare bitsen met 1/4" hex-opname. Boormachine zijde eveneens 1/4" hex-opname. Japans kwaliteitsproduct.

Order nr.	728541001	
Orig. nr.	PRO75	
Maximum koppel	Nm	75
Prijs	€	69,90

TOOLS



180°

VERSTELBAAR



Haakse bitshouder. Met deze bitshouder bereikt u de meeste onmogelijke hoekjes. Voor alle gangbare bitsen met 1/4" hex-opname. Boormachine zijde eveneens 1/4" hex-opname. Japans kwaliteitsproduct.

Order nr.	728540100	
Orig. nr.	PRO75F	
Maximum koppel	Nm	75
Prijs	€	77,90

TOOLS

MOMENTSLEUTELS

Teng Tools biedt een uitgebreide serie momentsleutels voor de professionele markt zowel in de automotive als ook in de industriële sector. Als toevoeging aan het bestaande range met moment-sleutels, schroevendraaiers en krachtvermeerderaars, verbetert en breidt Teng Tools constant het aanbod van aandrijfmomentproducten uit.

Precieze kracht

Met de Teng Tools geijkte momentsleutels span je makkelijk moeren of bouten met een bepaalde kracht aan. De kleinere draaimoersleutels hebben een kleiner en preciezer krachtbereik (1-5 Nm). Grote momentsleutels hebben een hoog en groot krachtbereik (200-100 Nm), en zijn ideaal voor het grovere werk. De momentsleutels van Teng Tools hebben een nauwkeurigheid van +/- 4%. Om die accuratesse te behouden, is het aangeraden om je momentsleutel elk jaar te laten ijken of calibreren. Want precisie, daar gaat het om!

De aansluiting

De momentsleutels van Teng Tools zijn geschikt om bouten en moeren aan te draaien met aansluiting 1/4", 3/8", 1/2" en 3/4".

Rechtse of bi-directionele werking

Teng Tools beschikt ook over bi-directionele momentsleutels. Met deze momentsleutels kan zowel links als rechts aangedraaid worden tot de juiste moment bereikt is.



CLEAR FOR TAKE OFF ACCORDING TO TENG



RUBEN, Flight Engineer

When it comes to flying you don't want to gamble. You want perfectly tuned machinery. To get that, you need a perfectly tuned workshop. For some, things organised perfectly might seem boring, but when it comes to getting clear for take-off, it's vital. Welcome to our world!

Get organised™



Momentsleutels

TENGOOLS

TYPE STANDARD



Momentsleutel. Rechtse werking.

Kenmerken:

- Ratelfunctie, zodat de momentsleutel zowel voor aandraaien als finaal aanspannen kan worden gebruikt.
- Richting omkeerbaar door middel van een hendel, maar enkel rechtshandig voor instellen moment.
- Hoekinstelling-schaal voor na het aanspannen.
- Aanduiding in Nm en Lbs.
- Vergrendelbare instelling.
- Nauwkeurigheid van +/- 4%.
- Gesatineerde afwerking met rode coating.
- Conform DIN3122.

Order nr.	Orig. nr.	Aansluiting inch	Bereik ISO Nm	Bereik lbs.in	Lengte mm	Prijs €
73190035	1492AGE	1/4	5-25	4-18	277	52,50
73190050	3892AGE-E1	3/8	5-25	4-18	277	57,50
73190076	3892AG-E3	3/8	19-110	14-81	368	65,90
73190191	1292AGEP	1/2	40-210	30-160	465	72,90
73190209	1292AGE-4	1/2	70-350	50-250	632	115,00
73190274	3492AGE-E	3/4	90-450	67-340	850	178,00
73190308	3492AGE-E1	3/4	140-700	100-500	1065	462,00
73190407	3492AGE-E2	3/4	140-980	100-700	1213	488,00

TENGOOLS

TYPE STANDARD



Momentsleutel. Bi-directionele werking.

Kenmerken:

- Geschikt voor linkse en rechtse werking dmv een push-through aandrijving.
- Ratelfunctie.
- Richting omkeerbaar dmv een hendel.
- Hoekinstelling-schaal voor na het aanspannen.
- Aanduiding in Nm en Lbs.
- Vergrendelbare instelling.
- Nauwkeurigheid van +/- 4%.
- Gesatineerde afwerking met rode coating.
- Conform DIN3122.

Order nr.	Orig. nr.	Aansluiting inch	Bereik ISO Nm	Bereik lbs.in	Lengte mm	Prijs €
73190175	1292AG-ER	1/2	40-200	30-160	465	72,90
73190258	1292AG-E4R	1/2	70-350	50-250	632	111,00
73190282	3492AG-ER	3/4	65-450	45-300	850	158,00

TENGOOLS

Q-TYPE MINI



Momentsleutel. Bi-directionele werking. Ideaal voor kleine ruimtes.

Kenmerken:

- Industriële kwaliteit voor de professioneel!
- Deze nieuwe lijn Teng Tools momentsleutels is speciaal gemaakt voor de professionele veeleisende gebruiker.
- Een laag eigengewicht en een 'slanke' uitvoering laat de gebruiker toe om deze momentsleutel te gebruiken in kleine beperkte ruimtes.
- Ratelfunctie, zodat de momentsleutel zowel voor aandraaien als finaal aanspannen kan worden gebruikt.
- Draaiknop in de ratelkop om de draairichting te wijzigen.
- Zeer eenvoudige instelling van het gewenste moment met vastzetfunctie op het handvatuiteinde.
- Quick release – eenvoudig verwijderen van de dopsleutel.
- Duidelijke maataanduiding in Nm en Lbs.
- Met analoge display
- Nauwkeurigheid van +/- 4% conform alle internationale industriële momentsleutel-standaards.
- Twee-richting werkend (klikt zowel in wijzer- als in niet-wijzer richting).
- Conform DIN3122.

Order nr.	Orig. nr.	Aansluiting inch	Bereik ISO Nm	Bereik lbs.in	Lengte mm	Prijs €
143870012	1492Q005	1/4	1-5	10-45	180	97,50
143870020	1492Q010	1/4	2-10	20-100	197	95,90
143870038	1492Q015	1/4	3-15	30-150	197	95,90
143870046	1492Q030	1/4	6-30	5-25	218	95,90
143870053	3892Q030	3/8	6-30	5-25	218	101,00

TENGOOLS

D-TYPE DIGITAL



Momentsleutel. Rechtse werking. Digitaal.

Kenmerken:







- Gemakkelijk in gebruik.
- Mogelijkheid tot 9 vast ingestelde momenten.
- De tolerantie (%) kan ingesteld worden door de gebruiker (van 0 tot 9%).
- Audiovisuele verwittiging wanneer het moment bereikt wordt: oranje licht vóór het bereiken van het moment, groen licht op het moment, rood licht over het moment.
- Met digitale display.
- Met heroproepbaar geheugen van de laatste 9 waarden.
- 3x standaard AA batterijen (niet meegeleverd).
- ISO 06789:2003.

Geleverd in een rode doos.

Geleverd met calibratie certificaat van fabriek.

Order nr.	Orig. nr.	Aansluiting inch	Bereik ISO Nm	Bereik lbs.in	Lengte mm	Prijs €
161810056	3892D100	3/8	10-100	7-75	457	263,00
161810106	1292D200	1/2	20-200	15-150	548	304,00

KIES UW MOMENTSLEUTEL

Order nr.	Orig. nr.	#	1 Nm	2 Nm	3 Nm	5 Nm	6 Nm	10 Nm	15 Nm	20 Nm	25 Nm	30 Nm	40 Nm	50 Nm	60 Nm	70 Nm	90 Nm	100 Nm	110 Nm	120 Nm	140 Nm	200 Nm	210 Nm	320 Nm	350 Nm	450 Nm	500 Nm	700 Nm	980 Nm	1000 Nm	
TYPE STANDARD			WERKING RECHTS																												
																															
73190035	1492AGE	1/4				5					25																				
73190050	3892AG-E1	3/8				5					25																				
73190076	3892AG-E3	3/8								20										110											
73190191	1292AG-EP	1/2											40											210							
73190209	1292AGE-4	1/2															70								350						
73190274	3492AG-E	3/4																90								450					
73190308	3492AG-E1	3/4																						140					700		
73190407	3492AG-E2	3/4																						140						980	
TYPE STANDARD			WERKING BI-DIRECTIONEEL																												
																															
73190175	1292AG-ER	1/2											40																		
73190258	1292AG-E4R	1/2															70														
73190282	3492AG-ER	3/4																90													
Q-TYPE MINI			WERKING BI-DIRECTIONEEL, VOOR KLEINE RUIMTES																												
																															
143870012	1492Q005	1/4	1			5																									
143870020	1492Q010	1/4		2																											
143870038	1492Q015	1/4			3																										
143870046	1492Q030	1/4				6																									
143870053	3892Q030	3/8				6																									
D-TYPE DIGITAL			DIGITAAL, WERKING RECHTS, 9 VAST INSTELBARE MOMENTEN, INSTELBARE TOLERANTIE 0-9%																												
																															
161810056	3892D100	3/8																													
161810106	1292D200	1/2																													
Q-TYPE ANALOG			WERKING BIDIRECTIONEEL, LAAG EIGENGEWICHT																												
																															
143870061	3892Q060	3/8																													
143870087	3892Q100	3/8																													
143870103	1292Q200	1/2																													
143870202	1292Q320	1/2																													
143870301	3492Q500	3/4																													
143870400	3492Q1000	3/4																													
																															
186260105	TQWC100	-																													
186260204	TQWC200	-																													
186260303	TQWC500	-																													

TOOLS

TENGOOLS



Q-TYPE ANALOG

Momentsleutel. Bi-directionele werking.

Kenmerken:

- Industriële kwaliteit voor de professioneel!
- Deze nieuwe lijn Teng Tools momentsleutels is speciaal gemaakt voor de professionele veeleisende gebruiker.
- Een laag eigengewicht en een 'slanke' uitvoering laat de gebruiker toe om deze momentsleutel te gebruiken in kleine beperkte ruimtes.
- Ratelfunctie zodat de momentsleutel zowel voor aandraaien als final aanspannen kan worden gebruikt.
- Draaiknop in de ratelkop om de draairichting te wijzigen.
- Zeer eenvoudige instelling van het gewenste moment met vastzetfunctie op het handvatuiteinde.
- Quick release – eenvoudig verwijderen van de dopsleutel.
- Duidelijke maataanduiding in Nm en Lbs.
- Met analoge display.
- Nauwkeurigheid van +/- 4% conform alle internationale industriële momentsleutel-standaards.
- Twee-richting werkend (klikt zowel in wijzer- als in niet-wijzer richting).
- Elke momentsleutel wordt geleverd met een individueel testcertificaat.
- Conform DIN3122.

Order nr.	Orig. nr.	Aansluiting inch	Bereik ISO Nm	Bereik lbs.in	Lengte mm	Prijs €
143870061	3892Q060	3/8	10-60	10-50	400	100,00
143870087	3892Q100	3/8	20-100	20-70	400	105,00
143870103	1292Q200	1/2	40-200	30-150	483	129,00
143870202	1292Q320	1/2	50-320	50-230	550	199,00
143870301	3492Q500	3/4	100-500	80-500	788	265,00
143870400	3492Q1000	3/4	200-1000	200-700	1250	589,00

TENGOOLS



Momentsleutel met accessoires in 22-delige set. TTX-tray.

Bestaande uit:

- 1 momentsleutel met rechtse werking en aansluiting 3/8".
- 10 opsteeksleutels.
- 8 bitsen TX.
- 1 bitshouder.
- 2 verlengstukken 3/8" L. 75 en 125mm.

Geleverd in een Teng tray geschikt voor elke Teng gereedschapskoffer of -wagen.

Order nr.	102110104					
Orig. nr.	TTX3892					
Aansluiting	inch	3/8				
Bitsen TX		8 · 10 · 15 · 20 · 25 · 27 · 30 · 40				
Verlengstukken 3/8"	mm	75 · 125				
Opsteeksleutels	mm	10 · 11 · 12 · 13 · 14 · 15 · 16 · 17 · 18 · 19				
Bereik	Nm	20-100				
Afmetingen (l x b x h)	mm	570 x 110 x 60				
Prijs	€	110,00				

TENGOOLS



5-delige set. TTX-tray.

Bestaande uit:

- 3 lange slagdoppen 1/2" van 17, 19 en 21mm
- 1 tang 240mm voor montage van balanceergewichten
- 1 momentsleutel 1/2".

Order nr.	122490105		
Orig. nr.	TTXW05		
Momentsleutel 1/2"	Nm	40-210Nm	
Pince d'équilibrage	mm	240	
Slagdoppen 1/2"	mm	17 · 19 · 21	
Afmetingen (l x b x h)	mm	570 x 110 x 40	
Prijs	€	102,00	

TENGOOLS



Set van 1 momentsleutel. Rechtse werking.

Kenmerken:

- Aansluiting 1/2".
- Kracht van 40-120 Nm.
- Richting omkeerbaar d.m.v. hendel maar enkel rechtshandig voor instellen moment.
- In een TTX Tray.

Order nr.	73190100		
Orig. nr.	TTX1292		
Aansluiting	inch	1/2	
Capaciteit	Nm	40-200	
Prijs	€	63,50	

TENGOOLS



Set. TTX-tray.

Bestaande uit:

- 1 momentsleutel 1/2" 40-210Nm
- 1 krachtvermeerderaar 1/2"-3/4" 1400Nm.

Order nr.	128220100		
Orig. nr.	TTXMP12		
Inkomende aansluiting	inch	1/2	
Krachtvermeerderaar	Nm	1400	
Momentsleutel 1/2"	Nm	40-200 (max. 200x3 met momentsleutel in deze set)	
Uitgaande aansluiting	inch	3/4	
Type gereedschap	momentsleutelset		
Prijs	€	331,00	

TENGOOLS



Gradencirkel momentsleutel. Voor de controle van bij het aandraaien van bouten/schroeven. Met statisch afleespunt. Aflezen mogelijk onder elke hoek dankzij dubbele hoekschaal. Afneembare magneet voor het aansluiten van 1/2" doppen.

Order nr.	231590100		
Orig. nr.	TQAG		
Aansluiting	inch	1/2	
Prijs	€	33,50	

TENGILOOLS



Momentsleutel. Bi-directionele werking.

Kenmerken:

- Met rechthoekige opname 9x12 of 14x18 mm.
- Eenvoudig afleesbare schaal in Nm en lbf.ft.
- Tolerantie 3%.
- Laag eigengewicht.
- Conform ISO 06789.

Geleverd in een rode plastic doos.

Geleverd met calibratie certificaat van fabriek.

Order nr.	Orig. nr.	Bereik ISO	Lengte mm	Aan-sluiting mm	Schaal lbf.ft	Torsie Nm	Prijs €
186260105	TQWC100	20-100	491	9x12	1,0		125,00
186260204	TQWC200	40-200	545	14x18	2,0		130,00
186260303	TQWC500	100-500	824	14x18	5,0		299,00

TENGILOOLS



Herstelkits voor herstelling van momentsleutels.

Order nr.	Orig. nr.	Aansluiting inch	Omschrijving	Prijs €
73191009	1492AGERK	1/4	repairkit voor 1492AG-E	15,00
143870657	1492Q005RK	1/4	repairkit voor 1492Q005	15,50
73191108	3892AGE1RK	3/8	repairkit voor 3892AG-E1	15,00
73191207	3892AGE3RK	3/8	repairkit voor 3892AG-E3	15,50
73191256	3892SPECRK	3/8	repairkit voor 3892-SPEC	16,30
143870756	3892Q030RK	3/8	repairkit voor 3892Q030	15,50
143870806	3892Q060RK	3/8	repairkit voor 3892Q060 en 3892Q100	11,60
73191405	1292AG4RK	1/2	repairkit voor 1292AG-E4	19,40
73191702	1292AG4RRK	1/2	repairkit voor 1292AG-E4R	26,70
73191306	1292AGERK	1/2	1292AG-ER / 1292AG-EP en 1292-SPEC	18,10
73191603	1292AGERRK	1/2	repairkit voor 1292AG-ER	18,90
143870905	1292Q200RK	1/2	repairkit voor 1292Q200 en 1292Q320	18,10
73191504	3492AG1RK	3/4	repairkit voor 3492AG-E1 en 3492AG-E2	62,30
73191801	3492AGERK	3/4	repairkit voor 3492AG-E	58,40
73191900	3492AGERRK	3/4	repairkit voor 3492AG-ER	77,40
143870954	3492Q500RK	3/4	repairkit voor 3492Q500	56,60

TENGILOOLS



Ratels voor momentsleutels. Met rechthoekige opname 9x12 of 14x18 mm. Geschikt voor TQWC 100 (opname 9x2) of TQWC 200-500 (opname 14x18).

Order nr.	Orig. nr.	Aansluiting inch	Aansluiting mm	Prijs €
186280103	3892CQ100R	3/8	9x12	16,90
186280202	1292CQ200R	1/2	14x18	18,90
186280301	3492CQ500R	3/4	14x18	65,90

TENGILOOLS



Opsteek-ringsleutels voor momentsleutels. Met rechthoekige aansluiting 9x12 of 14x18 mm.

Order nr.	Orig. nr.	Aansluiting mm	Maat mm	Prijs €
186310405	690710	9x12	10	12,90
186310504	690711	9x12	11	12,90
186310603	690712	9x12	12	12,90
186310702	690713	9x12	13	13,90
186310801	690714	9x12	14	13,90
186310900	690715	9x12	15	13,90
186311007	690716	9x12	16	13,90
186311106	690717	9x12	17	13,90
186311205	690718	9x12	18	14,50
186311304	690719	9x12	19	14,50
186311403	690813	14x18	13	14,50
186311502	690814	14x18	14	14,50
186311601	690815	14x18	15	14,50
186311700	690816	14x18	16	14,50
186311809	690817	14x18	17	14,90
186311908	690818	14x18	18	14,90
186312005	690819	14x18	19	15,50
186312104	690821	14x18	21	16,50
186312203	690822	14x18	22	16,50
186312302	690824	14x18	24	16,50
186312401	690826	14x18	26	16,90
186312500	690827	14x18	27	16,90
186312609	690829	14x18	29	16,90
186312708	690830	14x18	30	16,90
186312807	690832	14x18	32	16,90
186312906	690834	14x18	34	18,50
186313003	690836	14x18	36	18,50
186313102	690838	14x18	38	19,50
186313300	690841	14x18	41	22,50
186313409	690842	14x18	42	22,50
186313508	690844	14x18	44	25,90
186313607	690846	14x18	46	25,90

TENGTOLS



Vooraf ingestelde momentsleutelset. Voor o.a. messing koppelingen in airconditioners. Accuraatheid +/- 4%.

Order nr.	186380101		
Orig. nr.	ACD01		
Vooraf ingestelde koppel	Nm	18 - 42 - 55 - 65	
Maat steeksleutel	mm	17 - 22 - 26 - 29	
Prijs	€	214,00	

TENGTOLS



Opsteek-ringsleutels voor momentsleutels. Met rechthoekige aansluiting 9x12 of 14x18 mm.

Order nr.	Orig. nr.	Aansluiting mm	Maat mm	Prijs €
186300406	690510	9x12	10	12,90
186300505	690511	9x12	11	12,90
186300604	690512	9x12	12	12,90
186300703	690513	9x12	13	13,90
186300802	690514	9x12	14	13,90
186300901	690515	9x12	15	13,90
186301008	690516	9x12	16	13,90
186301107	690517	9x12	17	13,90
186301206	690518	9x12	18	13,90
186301305	690519	9x12	19	13,90
186301404	690613	14x18	13	14,50
186301503	690614	14x18	14	14,50
186301602	690615	14x18	15	14,50
186301701	690616	14x18	16	14,50
186301800	690617	14x18	17	14,50
186301909	690618	14x18	18	14,50
186302006	690619	14x18	19	14,50
186302105	690621	14x18	21	14,50
186302204	690622	14x18	22	14,50
186302303	690624	14x18	24	15,50
186302402	690626	14x18	26	15,50
186302501	690627	14x18	27	15,50
186302600	690629	14x18	29	14,90
186302709	690630	14x18	30	14,90
186302808	690632	14x18	32	15,50
186302907	690634	14x18	34	16,90
186303004	690636	14x18	36	16,90
186303103	690638	14x18	38	17,90
186303202	690640	14x18	40	17,90
186303301	690641	14x18	41	20,90
186303400	690642	14x18	42	20,90
186303509	690644	14x18	44	23,50
186303608	690646	14x18	46	23,50

TENGTOLS



TORQ02

TORQ03-04-05

Digitaal calibretoestel voor momentsleutels. Precisie is +1% van de gemeten waarde. Geleverd met calibratiecertificaat (klokgewijs).

Order nr.	Orig. nr.	Aansluiting inch	Bereik lbf.ft	Bereik Nm	Prijs €
186540209	TORQ02	1/4, 3/8	1.10-22.0	1.5-30	659,00
186540308	TORQ03	1/4, 3/8	5.5-110	7.5-150	659,00
186540407	TORQ04	3/8, 1/2	18-370	25-500	659,00
186540506	TORQ05	1/2, 3/4	36-740	50-1000	715,00

TENGTOLS

NEW



Digitale momentsleutel tester 10-400 Nm

Kenmerken:

- Robuust en eenvoudig in gebruik
- Nauwkeurigheid is 1% van de gemeten waarde
- Aanpasbare richtwaarde
- Tolerantie kan gekozen worden als 4% of 6% van de te meten waarde
- Diodes tonen of de testwaarden binnen de tolerantie valt
- Slaat het gemiddelde van de laatste 3 testwaardes op
- Geleverd met kalibratiecertificaat voor kloksgewijs gebruik.

Order nr.	199790106		
Orig. nr.	TORQ99E		
Bereik ISO	Nm	10-400	
Prijs	€	645,00	

TENGTTOOLS



Digitale momentsleutel tester 10-400 Nm met voet TORQS01 en printer TORP01E.

Kenmerken:

- Robuust en eenvoudig in gebruik
- Nauwkeurigheid is 1% van de gemeten waarde
- Aanpasbare richtwaarde
- Tolerantie kan gekozen worden als 4% of 6% van de te meten waarde
- Diodes tonen of de testwaarden binnen de tolerantie valt
- Met printer om een testrapport te printen met de laatste 3 gemeten waarden.
- Op stabiele voeten zodat de tester op werkhooft staat. Aanpasbare voeten voor meer stabiliteit op oneffen werkvloeren.
- Geleverd met kalibratiecertificaat voor kloksgewijs gebruik.

Order nr.	231620105
Orig. nr.	TORQ
Prijs	€ 1.359,00

TOOLS

TANGEN

Bij het ontwikkelen van het nieuw gamma tangen hebben we rekening gehouden met de Europese markt en de wensen van de eindgebruiker. Het materiaal en het design werden verbeterd. Het gamma werd eveneens gecompleteerd. De twee componenten handvaten geven niet enkel een goede grip; ze zien er ook fantastisch uit!

- Nieuw gelegeerd staal met CrMo voor een betere knipfunctie.
- Volledig gelijkvormig geslepen kopstuk.
- Nieuw dunner design volgens Europese stijl.
- Rubber/vinyl handvat in 1 kleur.
- Nieuw design voor de 2-componenten handvaten, in lijn met het nieuw Teng Tools design.
- Snijcapaciteit met lasermarkering aangeduid bij de kniplijn.





Get organised™



Tangen

TENGTOLS



Zijkniptang. Voor middelharde en harde draad. Zweeds model. Met vinyl-bekleed handvat.

Order nr.	Orig. nr.	Lengte	Capaciteit pianodraad	Capaciteit staaldraad	Capaciteit ijzerdraad	Capaciteit koperdraad	Prijs
		mm	mm	mm	mm	mm	€
74210154	MB441-5	135	1,5	1,8	2,3	4,0	13,50
74210105	MB441-6	155	1,6	2,0	2,5	4,0	14,90
74210147	MB442-5	140	1,6	2,0	4,0	4,0	16,50
74210170	MB442-6	160	2,0	2,5	2,5	4,0	14,90
74210196	MB442-7	180	2,0	2,5	4,0	4,2	19,90
74210204	MB442-8	200	2,5	4,0	4,0	4,2	15,90

TENGTOLS



Zijkniptang. Voor middelharde en harde draad. Zweeds model. Ergonomisch twee-componenten TPR-handvat.

Order nr.	109740100	109740209
Orig. nr.	MB441-5T	MB441-6T
Lengte	mm 135	155
Capaciteit pianodraad	mm 1,5	1,6
Capaciteit staaldraad	mm 1,8	2,0
Prijs	€ 14,90	16,90

TENGTOLS



Extra-zware zijkniptang. Voor harde staaldraad. Amerikaans model. Ergonomisch twee-componenten TPR-handvat.

Order nr.	109750109	109750208
Orig. nr.	MB442-6T	MB442-8T
Lengte	mm 160	200
Capaciteit pianodraad	mm 2	2,5
Capaciteit staaldraad	mm 2,5	3,0
Capaciteit ijzerdraad	mm 3,8	4,0
Prijs	€ 17,50	19,90

TENGTOLS



Extra-zware zijkniptang met gebogen kop 15°. Voor harde staaldraad. Amerikaans model. Ergonomisch twee-componenten TPR-handvat.

Order nr.	109750307
Orig. nr.	MB442B-8T
Lengte	mm 200
Capaciteit pianodraad	mm 2,5
Capaciteit staaldraad	mm 3
Capaciteit ijzerdraad	mm 4,0
Prijs	€ 18,90

TENGTOLS



Zijkniptang met veer, voor staaldraad, ijzerdraad en koperdraad. Chroom molybdenum staal. Vinyl beklede handvatten. DIN 5749.

Order nr.	178390100
Orig. nr.	MB442-7S
Lengte	mm 180
Capaciteit pianodraad	mm 2,0
Capaciteit staaldraad	mm 2,5
Capaciteit ijzerdraad	mm 4,0
Capaciteit koperdraad	mm 4,2
Prijs	€ 23,50

TENGTOLS



Snijkniptang voor kunststof. Geschikt voor kunststof en zacht materiaal zoals lood en tin. Gepolijste afwerking. Met veer. Vinyl bekleed handvat.

Order nr.	177940103	177940202	177940301
Orig. nr.	MB541-5	MB541-6	MB541-7
Lengte	mm 125	150	180
Prijs	€ 20,50	21,90	26,90

TENGTOLS



Kabelniptang. Chroom molybdenum staal. Voor koperen en aluminium kabels. Twee snijposities. Kan met een hand gebruikt worden. Vinyl bekleed handvat.

Order nr.	116760059	116760158	116760208
Orig. nr.	MB444-6	MB444-8	MB444-10
Lengte	mm 160	200	250
Capaciteit koperdraad	mm ² 22	38	60
Prijs	€ 20,50	24,50	32,90

TENGOOLS



Kabelkniptang. Professionele kwaliteit. Met titanium gecoate scharnier. Voor koper en aluminiumkabels. Ergonomisch twee-componenten TPR-handvat.

Order nr.	109760108 ^T	
Orig. nr.	MB444-8T	
Lengte	mm	200
Capaciteit koperdraad	mm	38
Prijs	€	20,90

TENGOOLS



Extra zware kabelkniptang. Chroom molybdenum staal. Voor koperen en aluminium elektrische kabels. Kan met een hand gebruikt worden. Vinyl bekleed handvat.

Order nr.	116760307 ^T	
Orig. nr.	MB445-10	
Lengte	mm	250
Koperen draad	mm ²	60
Prijs	€	35,50

TENGOOLS



Kabelknipper. Matrijsgesmede. De chroom molybdenium staal bladen zijn gehard om kanten te knippen. Knipt koper en aluminium elektrische kabels tot 2AWG (14 mm²) diameter HRC 60-62.

Order nr.	144050101 ^T	
Orig. nr.	496	
Lengte	mm	250
Snijcapaciteit	mm	12
Maximum kabelgrootte	mm ²	14 (2AWG)
Prijs	€	20,90

TENGOOLS



Staaldradschaar met terugspringveer.

Order nr.	86970100 ^T	
Orig. nr.	498-7	
Lengte	mm	190
Capaciteit pianodraad	mm	2,5
Capaciteit staaldraad	mm	7
Capaciteit roestvrij staal	mm	4
Prijs	€	27,90

TENGOOLS



Moeniertang-betonijzertang. DIN ISO 9242. Inductief nageharde bekken. Chroom vanadium staal. Zwart gefosfateerd met vinyl-bekleed handvaten.

Order nr.	177960101 ^T	177960200 ^T	177960309 ^T
Orig. nr.	MB449-9	MB449-10	MB449-11
Lengte	mm	230	250
Capaciteit staaldraad	mm	1,8	2,0
Capaciteit ijzerdraad	mm	2,0	2,2
Capaciteit koperdraad	mm	3,4	3,8
Prijs	€	20,90	23,50
			24,50

TENGOOLS



Kopkniptang.

Order nr.	99960155 ^T	99960171 ^T
Orig. nr.	MB448-6	MB448-8
Lengte	mm	160
Capaciteit staaldraad	mm	1,6
Capaciteit ijzerdraad	mm	1,8
Capaciteit koperdraad	mm	3,4
Prijs	€	21,50
		26,90

TENGOOLS



Nijptang met snijhoek 85°.

Order nr.	185930104 ^T	185930203 ^T
Orig. nr.	MB489-7	MB489-8
Lengte	mm	180
Capaciteit in staal	mm	1,6
Capaciteit in ijzer	mm	2,0
Prijs	€	20,50
		24,50

TENGOOLS



Combinatietang. Met vinyl-bekleed handvat.

Order nr.	74190075 ^T	74190083 ^T
Orig. nr.	MB451-7	MB451-8
Lengte	mm	175
Capaciteit pianodraad	mm	1,8
Capaciteit staaldraad	mm	2
Prijs	€	15,50
		16,90

TENGOOLS



Zware combinatietang. Chroom molybdenum staal. Vinyl beklede handvatten. DIN 5746.

Order nr.	Orig. nr.	Lengte	Capaciteit pianodraad	Capaciteit staaldraad	Capaciteit ijzerdraad	Prijs
		mm	mm	mm	mm	€
74190026	MB452-6	160	1,6	1,8	3,4	16,50
74190059	MB452-7	180	1,8	2,0	3,8	17,50
74190109	MB452-8	200	2,0	2,2	4,0	18,90
74190307	MB452-9	225	2,0	2,2	4,0	25,90

TENGOOLS



Combinatietang. Ergonomisch twee-componenten TPR-handvat. DIN5746.

Order nr.	109770107	109770206	109770305
Orig. nr.	MB452-6T	MB452-7T	MB452-8T
Lengte	mm 160	mm 180	mm 200
Capaciteit pianodraad	mm 1,6	mm 1,8	mm 2
Capaciteit staaldraad	mm 1,8	mm 2,0	mm 2,2
Capaciteit ijzerdraad	mm 3,4	mm 3,8	mm 4,0
Prijs	€ 17,90	€ 19,90	€ 21,90

TENGOOLS



Lange rechte bektang. Met vinyl-bekleed handvat. MB463-8 met bek 45° gebogen. DIN5746.

Order nr.	Orig. nr.	Lengte mm	Neuslengte mm	Prijs €
74230038	MB461-5	140	50	14,90
74230053	MB461-6	160	55	12,90
74230103	MB461-8	200	65	15,90
74230152	MB463-5	140	50	16,50
74230178	MB463-6	160	55	18,50
74230202	MB463-8	200	65	16,90

TENGOOLS



Lange rechte bektang. Ergonomisch twee-componenten TPR-handvat. DIN5746.

Order nr.	109780106	109780205
Orig. nr.	MB461-6T	MB461-8T
Lengte	mm 150	mm 200
Neuslengte	mm 55	mm 65
Prijs	€ 16,50	€ 19,50

TENGOOLS



Lange gebogen bektang. Bek, 45° hoek. Ergonomisch twee-componenten TPR-handvat. DIN5746.

Order nr.	109790105
Orig. nr.	MB463-8T
Lengte	mm 200
Neuslengte	mm 65
Prijs	€ 19,90

TENGOOLS



Telefoontang. Chroom molybdenum staal. Gepolijste kop. Gekartelde gripoppervlak. Vinyl-bekleed handvat. DIN 5745.

Order nr.	116770158
Orig. nr.	MB464-6
Lengte	mm 165
Beklengte	mm 55
Prijs	€ 15,90

TENGOOLS



Telefoontang. Lang recht bekken. Chroom molybdenum staal. Gepolijste kop. Gekartelde gripoppervlak. Ergonomisch twee-componenten TPR-handvat. DIN 5745.

Order nr.	109800102
Orig. nr.	MB464-6T
Lengte	mm 165
Neuslengte	mm 55
Prijs	€ 14,90

TENGOOLS



Lange ronde bektang. Chroom molybdenum staal. Gepolijste afwerking. Met veer. Gladde tips. Vinyl bekleed handvat.

Order nr.	177950052
Orig. nr.	MB465-6
Lengte	mm 150
Beklengte	mm 45
Prijs	€ 16,50

TENGOOLS



Naald bektang. Staal met hoog koolstofgehalte. Handvatten met veer. Vinyl beklede handvatten.

Order nr.	177950201	177950300
Orig. nr.	MBM468	MBM469
Lengte mm	150	150
Neuslengte mm	40	35
Type	recht	gebogen
Prijs €	18,50	18,50

TENGOOLS



Ronde bektang geschikt voor electronica. Staal met hoog koolstofgehalte. Handvatten met veer. Vinyl beklede handvatten.

Order nr.	177950102
Orig. nr.	MBM467
Lengte mm	125
Neuslengte mm	18
Prijs €	18,50

TENGOOLS



Mini-tangen. Mini-zijkniptang. Mini-kopkniptang. Mini-lange rechte bektang. Mini-telefoon tang.

Order nr.	Orig. nr.	Lengte mm	Prijs €
99960106	MBM441	110	14,90
99960205	MBM449	110	14,90
99960304	MBM461	125	13,50
99960502	MBM464	125	12,90

TENGOOLS



Universele waterpomptang. DIN 8976 Type C. Met 7 verstelposities. Chroom vanadium staal. Met vinyl-beklede handvat.

Order nr.	74170051	74170101
Orig. nr.	MB481-7	MB481-10
Lengte mm	180	250
Capaciteit mm	3-25	45
Prijs €	16,90	19,50

TENGOOLS



Universele waterpomptang. DIN 8976 Type C. Met 7 verstelposities. Chroom vanadium staal. Ergonomisch twee-componenten TPR-handvat.

Order nr.	109420109	109420208
Orig. nr.	MB481-7T	MB481-10T
Lengte mm	180	250
Capaciteit mm	3-25	3-38
Prijs €	17,50	20,90

TENGOOLS



MB481-10TQ

MB481-10Q



Waterpomptang met handig kliksysteem. Chroom vanadium staal. Met vinyl-beklede handvat.

Order nr.	186230207	186230108
Orig. nr.	MB481-10TQ	MB481-10Q
Lengte mm	250	250
Capaciteit mm	3-38	3-38
Prijs €	29,50	28,50

TENGOOLS



Universele waterpomptang. DIN 8976 Type A. Zware-uitvoering. Met verstelbaar scharnier met groeven. Chroom vanadium staal. Met vinyl-beklede handvat.

Order nr.	105930051	105930077	105930101
Orig. nr.	MB410	MB412	MB416
Lengte mm	250	300	400
Capaciteit mm	45	60	90
Prijs €	17,50	27,50	42,90

TENGOOLS



Ontmanteltang. Met veer en vastzetschroef. Voor draad met capaciteit van 0,2 tot 4,5mm. Ergonomisch twee-componenten TPR-handvat.

Order nr.	08700106
Orig. nr.	MB499-7T
Lengte mm	155
Voor draaddiameter mm	0,2-4,5
Prijs €	17,90



Set van 4 Mega Bite tangen met kunststof zwart-rode handgrepen.

Bestaande uit:

- 1 waterpomptang 250mm
- 1 zijknijptang 150mm
- 1 lange bektang 200mm
- 1 combinatietang 175mm

Geleverd met een wandrek voor montage op een muur of wandpaneel.

Order nr.	128330107 ⓘ
Orig. nr.	WRMB04
Prijs	€ 61,50



Set van 8 tangen.

Bestaande uit:

- 2 waterpomptangen (175 en 200)
- 2 combinatietangen (150 en 200)
- 2 zijknijptangen (150 en 200)
- 2 platbektang (150 en 200).

Kenmerken:

- Chroom-molybdeen staal.
- Ergonomisch twee componenten handvat.
- TTD tray.

Order nr.	174360107 ⓘ
Orig. nr.	TTD44-T
Afmetingen (l x b x h)	mm 280 x 280 x 50
Prijs	€ 115,00



Set van 4 Mega Bite tangen.

Bestaande uit:

- 1 waterpomptang 250mm
- 1 zijknijptang 150mm
- 1 lange bektang 200mm
- 1 combinatietang 175mm

Kenmerken:

- Met zwart-rode vinyl-beklede anti-slip handvaten.
- TC-tray.

Order nr.	44280105 ⓘ
Orig. nr.	TT440
Zijknijptang	mm 150
Combinatie tangen	mm 175
Waterpomptangen	mm 250
Lange bektang	mm 200
Prijs	€ 57,90



Set van 4 Mega Bite tangen.

Bestaande uit:

- 1 waterpomptang 250mm
- 1 zijknijptang 150mm
- 1 lange bektang 200mm
- 1 combinatietang 175mm.

Kenmerken:

- Met een ergonomisch zwart-rood twee-componenten TPR-handvat.
- TC-tray.

Order nr.	109820101 ⓘ
Orig. nr.	TT440-T
Zijknijptang	mm 150
Combinatie tangen	mm 175
Lange bektang	mm 200
Waterpomptangen	mm 250
Afmetingen (l x b x h)	mm 265 x 142 x 50
Prijs	€ 58,50

Tangen 1000V

TENGOOLS



18-delige 1000V-set bestaande uit 13 schroevendraaiers en 5 tangen.

Order nr.	178700100	
Orig. nr.	TV18N	
Aantal stuks	18	
Combinatie tangen	mm	200
Platte bektangen	mm	200
Ontmanteltang	mm	180
Zijkniptang	mm	150-200
Platte schroevendraaiers	mm	2,5 - 3,0 - 4,0 - 5,5 - 6,5
Schroevendraaiers PH		0 - 1 - 2 - 3
Schroevendraaiers PZ		0 - 1 - 2 - 3
Prijs	€	189,00

TENGOOLS

Set van 4 geïsoleerde 1000V tangen klasse EN 60900.

**Bestaande uit:**

- 1 zijkniptang
- 1 lange bektang
- 1 kabelstriptang
- 1 combinatietang

Kenmerken:

- Geïsoleerde kunststof handgrepen.
- TC-tray.

Order nr.	117490102	
Orig. nr.	TTV440	
Zijkniptang	mm	150
Combinatie tangen	mm	175
Lange bektang	mm	200
Ontmanteltang	mm	175
Prijs	€	64,50

TENGOOLS



Set van 4 geïsoleerde tangen met twee componenten handvat, 2 zijkniptangen, combinatietang en lange neus tang.

Elke tang wordt individueel getest en goedgekeurd. Vervaardigd en getest volgens de norm IEC 60900 voor werken onder spanning tot 1000 volt.

Geleverd met wandrek.

Order nr.	174530105	
Orig. nr.	17453-0105	
Prijs	€	74,90

TENGOOLS



Zware zijkniptang 1000V - EN/DIN 60 900. Voor harde staaldraad. Amerikaans model. Ergonomisch twee-componenten TPR-handvat.

Order nr.	117580100	
Orig. nr.	MBV441-6	
Lengte	mm	150
Capaciteit pianodraad	mm	1,6
Prijs	€	19,90

TENGOOLS



Combinatietang 1000V - EN/DIN 60 900. Ergonomisch twee-componenten TPR-handvat.

Order nr.	117610105	117610204
Orig. nr.	MBV451-7	MBV451-8
Lengte	mm	175
Capaciteit pianodraad	mm	1,8
Prijs	€	23,90

TENGOOLS



Extra-zware zijkniptang 1000V. EN/DIN 60 900. Voor harde staaldraad. Amerikaans model. Ergonomisch twee-componenten TPR-handvat.

Order nr.	117590109	
Orig. nr.	MBV442-8	
Lengte	mm	200
Capaciteit pianodraad	mm	2,5
Prijs	€	26,90

TENGOOLS



Lange rechte bektang 1000V - EN/DIN 60 900. Ergonomisch twee-componenten TPR-handvat.

Order nr.	117620104	
Orig. nr.	MBV461-8	
Lengte	mm	200
Neuslengte	mm	65
Prijs	€	21,90

TENGOOLS



Ontmanteltang 1000V - EN/DIN 60 900. Met veer en vastzetschroef. Voor draad met capaciteit van 0.2 tot 4.5mm. Ergonomisch twee-componenten TPR-handvat.

Order nr.	117630103	
Orig. nr.	MBV499-7	
Lengte	mm	155
Voor draaddiameter	mm	0,2-4,5
Prijs	€	22,50

Circlipstangen

TENGOOLS



Set van 4 circlipstangen L.125mm. TC-tray.

Bestaande uit:

- 1 recht inwendig
- 1 recht uitwendig
- 1 gebogen inwendig
- 1 gebogen uitwendig model

Order nr.	112520101 ⓘ
Orig. nr.	TT474-5
Circlips tangen	mm Recht inwendig 10x25 - Gebogen inwendig 10x25 - Recht uitwendig 10x25 - Gebogen uitwendig 10x25
Prijs	€ 40,90

TENGOOLS



Set van 4 circlipstangen L.175mm. TC-tray.

Bestaande uit:

- 1 recht inwendig
- 1 recht uitwendig
- 1 gebogen inwendig
- 1 gebogen uitwendig model

Order nr.	04030102 ⓘ
Orig. nr.	TT474-7
Circlips tangen	mm recht inwendig 12x65mm - gebogen inwendig 12x65 - recht uitwendig 12x65mm - gebogen uitwendig 12x65mm
Prijs	€ 46,50

TENGOOLS



Rechte en gebogen circlipstangen voor inwendige circlipsen.

Order nr.	Orig. nr.	Lengte mm	Type mm	Voor circlips SgH mm	Prijs €
34960054 ⓘ	MB470-5	125	recht	10-25	12,90
34960104 ⓘ	MB470-7	175	recht	19-60	15,50
34960153 ⓘ	MB470-9	225	recht	40-100	22,50
34960179 ⓘ	MB471-5	125	gebogen	10-25	12,90
34960203 ⓘ	MB471-7	175	gebogen	19-60	14,90
34960302 ⓘ	MB471-9	225	gebogen	40-100	22,50

TENGOOLS



Set van 4 circlipstangen L.225mm. TTX-tray.

Bestaande uit:

- 1 recht inwendig
- 1 recht uitwendig
- 1 gebogen inwendig
- 1 gebogen uitwendig model

Order nr.	112700109 ⓘ
Orig. nr.	TTX474-9
Tangen circlips recht inwendig	mm 32x80
Tangen circlips gebogen inwendig	mm 32x80
Tangen circlips recht uitwendig	mm 32x80
Tangen circlips gebogen uitwendig	mm 32x80
Afmetingen (l x b x h)	mm 265 x 142 x 50
Prijs	€ 71,50

TENGOOLS



Rechte en gebogen circlipstangen voor uitwendige circlipsen.

Order nr.	Orig. nr.	Lengte mm	Type mm	Voor circlips SgH mm	Prijs €
35020056 ⓘ	MB472-5	125	recht	10-25	12,90
35020106 ⓘ	MB472-7	175	recht	10-40	14,90
35020155 ⓘ	MB472-9	225	recht	32-80	22,50
35020171 ⓘ	MB473-5	125	gebogen	10-25	12,90
35020205 ⓘ	MB473-7	175	gebogen	10-40	14,90
35020304 ⓘ	MB473-9	225	gebogen	32-80	22,50

TENGOOLS



Universele circlipstang met 4 verwisselbare koppen die 8 verschillende combinaties mogelijk maken. Zowel voor inwendige als uitwendige circlipsen. De tips zijn licht magnetisch. Met terugveer. Met vinyl-bekleed handvat.

Order nr.	74150103 ⓘ
Orig. nr.	480
Lengte	mm 150
Voor circlips	mm 10-50
Prijs	€ 14,90

Griptangen

TENGOOLS



Set van 5 griptangen. TC-tray.

Bestaande uit:

- 3 met ronde bek 100, 175 en 250mm
- 2 met lange bek 100 en 150mm

Order nr.	122480106 ⓘ		
Orig. nr.	TTVG05		
Klassieke griptangen	mm	100 - 175 - 250	
Griptangen lange dunne bekken	mm	100 - 150	
Prijs	€	50,90	

TENGOOLS



Set van 4 griptangen.

Bestaande uit:

- 1 C-bek 250mm (type 406)
- 1 platte bek 200mm (type 408)
- 1 gebogen bek 225mm (type 407)
- 1 lange bek type 160mm (type 404).

Geleverd in een PVC tray. PS-tray.

Order nr.	106230105 ⓘ		
Orig. nr.	TTSPSPG		
Prijs	€	55,50	

TENGOOLS



Set van 2 griptangen bestaande uit de klassieke griptang 401-10 en de griptang 404-6 met lang dun bekken. Beide met knipfunctie.

Order nr.	116780107 ⓘ		
Orig. nr.	402		
Prijs	€	26,90	

TENGOOLS



Klassieke griptang met gekartelde gebogen bekken. Met knipfunctie.

Order nr.	Orig. nr.	Lengte mm	Afmetingen mm	Prijs €
74250036 ⓘ	401-4	100	0-25	10,50
74250044 ⓘ	401-5	125	0-28	12,90
74250051 ⓘ	401-7	175	0-38	14,50
74250101 ⓘ	401-10	250	0-47	15,50
74250200 ⓘ	40112	300	0-50	21,50

TENGOOLS



Klassieke griptang met gekarteld plat bekken.

Order nr.	101920106 ⓘ		101920205 ⓘ	
Orig. nr.	401-10F		401-12F	
Lengte	mm	250	300	
Afmetingen	mm	0-45	0-52	
Prijs	€	17,50	21,50	

TENGOOLS



Griptang met lang dun bekken. Met knipfunctie.

Order nr.	74270059 ⓘ	74270109 ⓘ	74270208 ⓘ
Orig. nr.	404-4	404-6	404-9
Lengte	mm	100	160
Bekbreedte	mm	2	6
Beklengte	mm	35	35
Prijs	€	10,90	12,90
			14,90

TENGOOLS



Griptang lange bek. Met extra smalle kaken en pijpgrip. Zelfsluitend en éénhandsmechanisme voor eenvoudige bediening. De moer op de instelknop vergemakkelijkt herhalingstaken. Vernikkeld.

Order nr.	186640306 ⓘ		
Orig. nr.	404-6S		
Lengte	mm	160	
Bekbreedte	mm	6	
Beklengte	mm	35	
Prijs	€	11,90	

TENGOOLS



Griptang met C-vormige bekken.

Order nr.	101930105 ⓘ		
Orig. nr.	406		
Lengte	mm	250	
Diepte uitlading	mm	70	
Hoogte uitlading	mm	100	
Afmetingen	mm	0-80	
Prijs	€	22,90	

TENGOOLS



Griptang met C-vormig bekken. Met beweegbare bekentips.

Order nr.	186650107 ⓘ		
Orig. nr.	406-6P		
Lengte	mm	172	
Bekwijdte	mm	0-50	
Diepte uitlading	mm	40	
Hoogte uitlading	mm	60	
Prijs	€	16,50	

TENGOOLS



Griptang met C-vormige bekken.

Order nr.	186650206 ⓘ		
Orig. nr.	406-6		
Lengte	mm	172	
Bekbreedte	mm	0-50	
Diepte uitlading	mm	40	
Hoogte uitlading	mm	60	
Prijs	€	14,50	

TENGOOLS



Griptang met C-vormig bekken met beweegbare bekkentips.

Order nr.	128300100	
Orig. nr.	406P	
Lengte	mm	275
Bekbreedte	mm	80
Prijs	€	27,90

TENGOOLS



Griptang met C-vormig bekken . Zelfsluitend en éénhandsmechanisme voor eenvoudige bediening. De moer op de instelknop vergemakkelijkt herhalingstaken. Vernikkeld.

Order nr.	186650503	186650404
Orig. nr.	406S	406-6S
Lengte	mm	285
Bekbreedte	mm	0-80
Diepte uitlading	mm	70
Hoogte uitlading	mm	100
Prijs	€	20,90

TENGOOLS



Griptang met C-vormig bekken met beweegbare bekkentips. Zelfsluitend en éénhandsmechanisme voor eenvoudige bediening. De moer op de instelknop vergemakkelijkt herhalingstaken. Vernikkeld.

Order nr.	186650305	186650602
Orig. nr.	406-6SP	406SP
Lengte	mm	172
Bekbreedte	mm	0-50
Diepte uitlading	mm	40
Hoogte uitlading	mm	60
Prijs	€	16,50

TENGOOLS



Griptang met lange C-vormig bekken met beweegbare bekkentips.

Order nr.	128310109	
Orig. nr.	409P	
Lengte	mm	300
Bekbreedte	mm	65
Prijs	€	23,50

TENGOOLS



Griptang 88mm C-type. Met beweegbare bekkentips. Zelfsluitend en éénhandsmechanisme voor eenvoudige bediening. De moer op de instelknop vergemakkelijkt herhalingstaken. Vernikkeld.

Order nr.	186640207	
Orig. nr.	409SP	
Lengte	mm	300
Bekbreedte	mm	0-88
Prijs	€	24,90

TENGOOLS



Griptafelklemtang met bek met aanpasbare tip. Montage op de klemtafel gebeurt door vastzetten van de tang op de tafel door 2vb gleufbouten. (niet meegeleverd).

Order nr.	128320108	
Orig. nr.	410P	
Lengte	mm	230
Bekbreedte	mm	65
Prijs	€	27,90

TENGOOLS



Griptang met Tslot . Zelfsluitend en éénhandsmechanisme voor eenvoudige bediening. De moer op de instelknop vergemakkelijkt herhalingstaken. Vernikkeld.

Order nr.	186640108	
Orig. nr.	410SP	
Lengte	mm	230
Diepte uitlading	mm	4,0
Hoogte uitlading	mm	65
Prijs	€	27,90

TENGOOLS



Griptang voor de lasser. Met dubbele bekkem.

Order nr.	101940104	
Orig. nr.	407	
Lengte	mm	225
Almetingen	mm	0-65
Prijs	€	20,90

TENGOOLS



Griptang 270mm voor lassen cap. 90mm. Zelfsluitend en éénhandsmechanisme voor eenvoudige bediening. De moer op de instelknop vergemakkelijkt herhalingstaken. Vernikkeld.

Order nr.	186640405	
Orig. nr.	407AS	
Lengte	mm	270
Bekbreedte	mm	85
Diepte uitlading	mm	0-90
Prijs	€	24,90

TENGOOLS



Griptang met 2 stevige wijde platte bekken.

Order nr.	101950103	
Orig. nr.	408	
Lengte	mm	200
Bekwijde	mm	75
Almetingen	mm	0-42
Prijs	€	16,50

Spanvijzen

TENGOOLS



NEW

Eenhandsspanklem met snelspanaansluiting.

- De vaste klauw is omkeerbaar voor inwendige klemming
- Krachtige hendel om een grote klemkracht recht uit te oefenen
- Snel te verwijderen dankzij de ontgrendelknop
- 2 componenten kunststof handvat
- Spanstukken bekleed met kunststof plaatjes

Order nr.	Orig. nr.	Klemkracht	Klemwijdte	Diepte uitlading	Prijs
		N	mm	mm	€
231490103	CMQ150	1580	150	85	13,50
231490202	CMQ300	1580	300	85	15,50
231490301	CMQ450	1580	450	85	17,50
231490400	CMQ600	1580	600	85	19,90

TENGOOLS



NEW

Eenhandsspanklem met klemkracht 1780 N.

- Krachtige hendel om een grote klemkracht recht uit te oefenen
- De hendel aan het uiteinde zorgt voor een snelle en comfortabele klemming
- Snel te verwijderen dankzij de ontgrendelknop
- 2 componenten kunststof handvat
- Bekken met kunststof plaatjes om de oppervlakken te beschermen

Order nr.	Orig. nr.	Klemkracht	Klemwijdte	Diepte uitlading	Prijs
		N	mm	mm	€
231500109	CMQL150	1780	150	80	19,50
231500208	CMQL300	1780	300	80	21,50
231500307	CMQL450	1780	450	80	24,90

TENGOOLS



NEW

Spanvijz.

- Versterkte gietijzeren armen
- Hoge kwaliteit geprofileerde rail
- Drukplaat met 2 componenten kunststof handvat
- Spanstukken bekleed met kunststof bekleding.

Order nr.	Orig. nr.	Afmetingen rail	Klemwijdte	Diepte uitlading	Prijs
		mm	mm	mm	€
231440108	CMD12	20,5x5	120	60	10,90
231440207	CMD16	25x6	160	80	11,90
231440306	CMD20	27x7	200	100	17,90
231440405	CMD25	29x9	250	120	18,50
231440504	CMD30	29x9	300	120	21,90
231440603	CMD30A	32x10	300	140	25,90
231440702	CMD40	32x10	400	140	26,50
231440801	CMD40A	32x10	400	175	29,90
231440900	CMD50	29x9	500	120	22,90
231441106	CMD80	29x9	800	120	28,90

TENGOOLS



Spanvijz. Volledig in gehard staal. L-vorm in 1 stuk. Met 90° knikbare hendel.

Order nr.	Orig. nr.	Maat	Klemkracht	Merk	Afmetingen rail	Prijs
		mm	kg		mm	€
128370103	CMF16T	160x80	250	Teng tools	16,5x7,5	21,90
128370202	CMF20T	200x100	400	Teng tools	19,5x9,5	27,50
128370301	CMF25T	250x120	550	Teng tools	22x10,5	32,90
128370400	CMF30T	300x140	650	Teng tools	25,0x12,0	40,50
128370509	CMF35T	300x100	400	Teng tools	25,0x12,0	40,50
722184000	EHREG40C	400x175	700	Ehoma	25x12	57,50
722184010	EHREG40C	400x120	750	Ehoma	25x12	42,90
722186000	EHREG60C	600x175	700	Ehoma	25x12	60,50
722186010	EHREG60C	600x120	750	Ehoma	25x12	47,90

TENGOOLS



Spanvijz. Volledig in gehard staal. L-vorm in 1 stuk. Met T-vormige hendel.

Order nr.	Orig. nr.	Maat	Klemkracht	Afmetingen rail	Prijs
		mm	kg	mm	€
128360104	CMF16	160x80	250	16,5x7,5	17,90
128360203	CMF20	200x100	400	19,5x9,5	27,50
128360302	CMF25	250x120	550	22x10,5	29,50
128360401	CMF30	300x140	650	25x12	36,50
128360500	CMF35	300x120	750	25x12	36,50
722174000	EHG40CS	400x175	700	27x13	51,90
722175000	EHS50CS	500x120	750	27x13	49,90
722176000	EHG60CS	600x175	700	27x13	56,50

TENGOOLS



Spanvijz.

- L-vorm in een stuk
- Snelspanhendel voor krachtige en snelle klemming
- De ratel voorkomt overbelasting en weerstaat trillingen
- Ergonomische klem- en loslaathendel
- Trillingsbestendig

Order nr.	Orig. nr.	Max. klemkracht	Afmetingen rail	Klemwijdte	Diepte uitlading	Prijs
		N	mm	mm	mm	€
231450107	CMFQ20	3432	19,5x9,5	200	100	48,90
231450206	CMFQ25	3933	22x10,5	250	120	55,90
231450305	CMFQ30	4903	25x12	300	140	66,50
231450404	CMFQ40	3593	25x12	400	120	70,50

TOOLS

Kabelschoentangen

TOOLS



299-delig assortiment van de meest gangbare geïsoleerde kabelschoenen. DTC tray TTD02.

Order nr.	161800310
Orig. nr.	TTD02T299
Prijs	€ 25,90

TENGI



121-delige set. TC-tray.

Bestaande uit:

- 1 kabelschoentang CP50 voor geïsoleerde kabelschoentjes (rode, blauwe en gele)
- assortiment van 120 kabelschoentjes

Order nr.	110380102
Orig. nr.	TTCP121
Prijs	€ 25,90

TENGI



4-delige set. TC-tray.

Bestaande uit:

- 1 automatische kabelschoentang met 3 klauwen voor respectievelijk
- geïsoleerde 22-10 AWG
- niet-geïsoleerde 22-12 AWG
- niet-geïsoleerde 22-8 AWG kabelschoenen

Order nr.	122470107
Orig. nr.	TTCP04
Voor geïsoleerde kabelschoenen	mm 22-10 AWG (0,324 mm ² - 5,261 mm ²)
Voor niet geïsoleerde ADEN-ER-hulzen	mm 22-12 AWG (0,324 mm ² - 3,31 mm ²)
Voor niet-geïsoleerde kabelschoenen	mm 22-8 AWG (0,3 mm ² - 8 mm ²)
Prijs	€ 60,50

TOOLS



Set bestaande uit krimptang met een universele snelkoppeling met 6 verwisselbare klauwensets. Stalen tang met kwalitatieve krimpklaauwen in AISI 4140 materiaal. Gehard HRC 38-45. Beide handvaten van de tang zijn in een 2-component materiaal PP+TPR voor een aangename en goeie grip.

Order nr.	100071907
Orig. nr.	VES1907
Lengte krimptang	mm 220
Capaciteit geïsoleerde kabelschoenen	AWG 22-18 - 16-14 - 12-10
Capaciteit niet-geïsoleerde kabelschoenen	AWG 20-18 - 16-14 - 12-10 - 8
Capaciteit kleine ADEN-ER-hulzen	AWG 22-20-18-16-14-12
Capaciteit grote ADEN-ER-hulzen	AWG 10-8-6
Capaciteit coaxiale (BNC) koppelingen	mm 6,48-5,41-2,50-1,72-0,823
Prijs	€ 98,90

TOOLS



Universele ontmantel- en krimptang. Geschikt voor geïsoleerde en niet-geïsoleerde kabelschoentjes. Met knipfunctie. Met vinyl-bekleed handvat.

Order nr.	100071090
Orig. nr.	VES1090
Lengte	mm 225
Capaciteit	mm 0,5 - 0,75 - 1 - 1,5 - 2,5 - 4 - 6
Prijs	€ 11,50

TENGI



Universele ontmantel- en krimptang. Geschikt voor geïsoleerde en niet-geïsoleerde kabelschoentjes. Met knipfunctie. Met vinyl-bekleed handvat.

Order nr.	58340209	58340308
Orig. nr.	CP50	CP51
Voor geïsoleerde kabelschoenen	mm 0,75 - 6	0,75 - 6
Lengte	mm 225	225
Ontmantelrand voor geleidingsdraad	mm ² 0,75 - 1 - 1,5 - 2,5 - 4 - 6	0,75 - 1 - 1,5 - 2,5 - 4 - 6
Voor snijden van bouten	mm 2,5 - 3 - 3,5 - 4 - 5	2,5 - 3 - 3,5 - 4 - 5
Voor uiteinden	mm rood - blauw - geel	rood - blauw - geel
Voor niet-geïsoleerde kabelschoenen	mm	
Prijs	€ 18,50	17,90

TENGOOLS



Ontmanteltang. Voor snel en eenvoudig ontmantelen van kabels van 0,2 tot 6 mm². Sniijdt kabels tot 2 mm.

Order nr.	186240107 ⓘ	
Orig. nr.	CP55	
Voor kabels	mm ²	0,2 - 6
Lengte aanslag	mm	20
Prijs	€	24,90

TENGOOLS



Automatische krimptang met kabelstrip -en knipfunctie. Met terug-springveer en sluiithandel.

Order nr.	186820106 ⓘ	
Orig. nr.	CP53	
Lengte	mm	180
Capaciteit	AWG	20-8
Capaciteit knipfunctie CU/AL	mm	1.0
Capaciteit	mm	0.8 1 1.3 1.4 2 2.6 3.2
Prijs	€	18,50

TENGOOLS



Automatische krimptang voor geïsoleerde en niet-geïsoleerde kabelschoenen, 24-10 AWG. Kabelstrip en -knipfunctie met micro instelknop voor kabels, 30-8 AWG.

Order nr.	186680104 ⓘ	
Orig. nr.	CP60	
Voor geïsoleerde kabelschoenen	mm	0.5-6
Voor niet-geïsoleerde kabelschoenen	mm	0.5-6
Lengte	mm	210
Capaciteit	AWG	8-30
Capaciteit	mm ²	0.13-8
Capaciteit geïsoleerde kabelschoenen	AWG	10-24
Capaciteit niet-geïsoleerde kabelschoenen	AWG	10-24
Prijs	€	20,90

TENGOOLS



Precisie krimptang. Met krachtoverbrengingsmechanisme (30% minder kracht uit te oefenen). Comfortabel ergonomisch handvat.

Order nr.	186670105 ⓘ	
Orig. nr.	CP58	
Lengte	mm	250
Capaciteit	AWG	22-10
Capaciteit	mm ²	0.75-6.0
Prijs	€	32,90

TENGOOLS



Professionele automatische ontmantel- en krimptang. Geschikt voor geïsoleerde kabelschoenen van 1.5 tot 6mm en niet-geïsoleerde kabelschoenen van 1.5 tot 2.5mm.

Order nr.	128390101 ⓘ	
Orig. nr.	CP52	
Prijs	€	44,50

TOOLS



Easy stripper tang. 1 tang - 3 functies : kniptang, ontmanteltang en kabelschoenkrimptang. Met kunststof bekleed handvat.

Order nr.	100073500 ⓘ	
Orig. nr.	VES3500	
Lengte	mm	210
Prijs	€	19,50

TOOLS



Automatische kabelschoenkrimptang voor geïsoleerde kabelschoenen. Met kunststof bekleed handvat.

Order nr.	100072188 ⓘ	
Orig. nr.	VES1000	
Lengte	mm	245
Capaciteit	AWG	22-18 - 16-14 - 12-10
Capaciteit DIN	mm ²	0,5-1,0 - 1,5-2,5 - 4-6
Prijs	€	37,90

TOOLS



Automatische kabelschoenkrimpang voor niet-geïsoleerde kabelschoenen. Met kunststof bekleed handvat.

Order nr.	100071100		
Orig. nr.	VES1100		
Lengte	mm	260	
Capaciteit	AWG	20-18 - 16-14 - 12-10 - 8	
Capaciteit DIN	mm ²	1,5 - 2,5 - 6 - 10	
Prijs	€	39,50	

TOOLS



Automatische kabelschoenkrimpang voor geïsoleerde en niet-geïsoleerde ADENER-hulzen 12-22mm. Met kunststof bekleed handvat.

Order nr.	100071200		
Orig. nr.	VES1200		
Lengte	mm	200	
Capaciteit DIN	mm ²	0,5 - 0,75 - 1 - 1,5 - 2,5 - 4	
Capaciteit ADENER	AWG	22 - 20 - 18 - 16 - 14 - 12	
Prijs	€	46,50	

TOOLS



Automatische kabelschoenkrimpang voor geïsoleerde en niet-geïsoleerde ADENER-hulzen 6-10mm. Met kunststof bekleed handvat.

Order nr.	100071300		
Orig. nr.	VES1300		
Lengte	mm	200	
Capaciteit DIN	mm ²	6 - 10 - 16	
Capaciteit ADENER	AWG	10 - 8 - 6	
Prijs	€	51,50	

TOOLS



Automatische krimpang voor COAX-leidingen. Met kunststof bekleed handvat.

Order nr.	100071500		
Orig. nr.	VES1500		
Lengte	mm	240	
Capaciteit Hex		1,72 - 2,5 - 5,4 - 6,48 - 8,2	
Prijs	€	46,90	

TOOLS



Automatische krimpang voor D-SUB en V3.5 fiches. Stalen tang met kwalitatieve krimpklauwen in AISI 4140 materiaal. Gehard HRC 38-45. Beide handvaten van de tang zijn in een 2-component materie PP+TPR voor een aangename en goeie grip.

Order nr.	100071550		
Orig. nr.	VES1550		
Capaciteit	AWG	14 - 22 - 8	
Capaciteit DIN	mm ²	2,5 - 0,5 - 8-10	
Lengte krimpang	mm	220	
Prijs	€	46,90	

TOOLS



Automatische kabelschoenkrimpang voor niet-geïsoleerde en interlocking kabelschoenen. Met kunststof bekleed handvat.

Order nr.	100071600		
Orig. nr.	VES1600		
Lengte	mm	228	
Capaciteit	AWG	20-18 - 16-14 - 12-10	
Prijs	€	50,50	

TOOLS



Automatische krimpang voor 4 of 8-draads telefoon- en netwerkbekabeling. Met kunststof bekleed handvat.

Order nr.	100072004		
Orig. nr.	VES2004		
Soort kabel	telefoon type		
Aantal draden	4		
Prijs	€	18,50	

TOOLS



Kabelkrimpang voor netwerkkabels.

Order nr.	100072045		
Orig. nr.	VES2045		
Lengte	mm	205	
Capaciteit RJ		10 - 11 - 12 - 45	
Prijs	€	40,50	

TOOLS



Universele kabelstripper. Cap. 8-28mm. Smpel en onmisbaar.

Order nr.	109070828	
Orig. nr.	VES0828	
Lengte	mm	170
Capaciteit diameter	mm	8-28
Prijs	€	5,50

TOOLS



Kabelstriptang.

Order nr.	109070058	
Orig. nr.	VES0058	
Capaciteit	RG58/59/62/3C/4C	
Prijs	€	8,90

TOOLS



Kabelknijptang. Ratelsysteemmodel. Eenhandsbediening. Voor CU/AL kabels. Niet voor staal of stalen kabels.

Order nr.	100070024	
Orig. nr.	VES4024	
Lengte	mm	310
Capaciteit maximum	mm ²	240
Prijs	€	74,50

TOOLS



Mechanische krimpang voor CU-terminals. Met roterende krimpklauwen en no-full-closure mechanisme.

Order nr.	100073050	100073120
Orig. nr.	VES3050	VES3120
Lengte	mm	390
Capaciteit	mm ²	6-50
Prijs	€	41,50

TOOLS



Mechanische krimpang met krimpcapaciteit 6T voor CU-terminals tot 300mm². Geleverd met 11 drukstukken gaande van 16, 25, 35, 50, 70, 95, 120, 150, 185, 240 en 300mm.

Order nr.	100073300	
Orig. nr.	VES3300	
Capaciteit	mm	
Prijs	€	224,00

TOOLS



Hydraulische kabelknijptang. Guillotine systeem knipt perfect en eenvormig in vergelijking met een mechanische 'hakken'. Een 180° roterend kniphoofd vergemakkelijkt voor de gebruiker een eenvoudig positioneren bij het knippen.

Order nr.	100070050	
Orig. nr.	VES4050	
Lengte	mm	710
Capaciteit	mm ²	4
Capaciteit elektrische kabel (diameter)	mm ²	50
Capaciteit knijpfunctie CU/AL	mm ²	20
Capaciteit telefoonkabel (diameter)	mm ²	38
Prijs	€	411,00

Riveteertangen

TENGOOLS



Klassieke riveteertang voor blindklinknagels.

Kenmerken:

- Capaciteit: diam. 2,4 tot 4,8mm voor alle materialen.
- Stalen gestampt lichaam.

Geleverd met:

- 4 kopstukken 2,4, 3,2, 4,0 en 4,8mm.

Order nr.	116820101		
Orig. nr.	HR14		
Capaciteit blindklinknagels in aluminium	mm	2,4 - 3,2 - 4,0 - 4,8	
Lengte	mm	270	
Prijs	€	25,90	

TOOLS



Klassieke riveteertang voor blindklinknagels. Voor vakmannen.

Kenmerken:

- Capaciteit : diam. 2,4 tot 4,8mm.
- Aluminium lichaam met stalen handgreep met stalen onderdelen.

Geleverd met:

- 4 kopstukken 2,4, 3,2, 4,0 en 4,8mm.

Order nr.	727817020		
Orig. nr.	RITC711		
Capaciteit blindklinknagels in aluminium	mm	2,4 - 3,2 - 4,0 - 4,8	
Prijs	€	15,90	

TENGOOLS



Klassieke riveteertang voor blindklinknagels. Voor handwerk en industrie.

Geleverd met:

- 4 kopstukken voor 2,4, 3,2, 4,0 en 4,8mm.

Order nr.	69070100		
Orig. nr.	HR01		
Capaciteit blindklinknagels in aluminium	mm	2,4 - 3,2 - 4,0 - 4,8	
Lengte	mm	250	
Prijs	€	33,90	

TOOLS



Riveteertang met 360° draaibare kop voor blindklinknagels.

Kenmerken:

- Gebreveteerd model.
- Bereikt alle onbereikbare hoekjes.
- Capaciteit : diam. 2,4 tot 4,8mm voor alle materialen.

Geleverd met:

- 4 kopstukken 2,4, 3,2, 4,0 en 4,8mm.

Order nr.	727819010		
Orig. nr.	RITC901KN		
Capaciteit blindklinknagels in aluminium	mm	2,4 - 3,2 - 4,0 - 4,8	
Prijs	€	24,90	

TOOLS



COMPACT



Accordeon-type riveteertang voor blindklinknagels. Voor vakmannen.

Kenmerken:

- Het accordeon-systeem garandeert een soepele krachtoverbrenging.
- Aluminium lichaam met stalen handgreep met stalen onderdelen.
- Voor klinknagels van 3,2 - 4,0 - 4 - 8 - 6,4 mm voor alle materialen.

Order nr.	727815010
Orig. nr.	RITC501
Capaciteit blindklinknagels in aluminium	mm 3,2 - 4,0 - 4 - 8 - 6,4
Prijs	€ 46,50

TOOLS



360° **3 IN 1**



Combinatie riveteertang 3 in 1.

Geslacht voor:

- Voor blindklinknagels 2,4 tot 4,8mm,
- Voor blindklinkmoeren M4, M5 en M6
- Voor blindklinkbouts M4, M5 en M6.

Kenmerken:

- Met 360° draaibare kop.
- Gebreveteerd model.
- Bereikt alle onbereikbare hoekjes.

Geleverd in een handige kunststof opbergkoffer.

Order nr.	727819090
Orig. nr.	RITC909G
Capaciteit blindklinknagels in aluminium	mm 2,4 - 3,2 - 4,0 - 4,8
Capaciteit blindklinkmoeren in aluminium	M 4 - 5 - 6
Capaciteit blindklinkbouts in aluminium	M 4 - 5 - 6
Prijs	€ 44,90

TOOLS



2 IN 1



Combinatie riveteertang 2 in 1

Geslacht voor:

- Voor blindklinkmoeren M4, M5 en M6
- Voor blindklinkbouts M4, M5 en M6.

Geleverd in een handige kunststof opbergkoffer.

Order nr.	727817100
Orig. nr.	RITC920
Capaciteit blindklinkmoeren in aluminium	M 4 - 5 - 6
Capaciteit blindklinkbouts in aluminium	M 4 - 5 - 6
Prijs	€ 44,90

TOOLS



3 IN 1



Combinatie riveteertang 3 in 1

Geslacht voor:

- Voor blindklinknagels 3,2 tot 6,4mm
- Voor blindklinkmoeren M4, M5, M6, M8 en M10
- Voor blindklinkbouts M4, M5, M8 en M10.

Kenmerken:

- Extra zware uitvoering.
- De openklapbare hendels garanderen een perfecte krachtoverbrenging en eveneens een compacte opbergmogelijkheid eenmaal ingeklapt.
- Gebreveteerd model.

Geleverd in een handige kunststof opbergkoffer. Accessoires los leverbaar.

Order nr.	727819500
Orig. nr.	RITC950
Capaciteit blindklinknagels in aluminium	mm 3,2 - 4,0 - 4,8 - 6,4
Capaciteit blindklinkmoeren in aluminium	M 4 - 5 - 6 - 8 - 10 - 12
Capaciteit blindklinkbouts in aluminium	M 4 - 5 - 6 - 8
Prijs	€ 89,50

TOOLS



Combinatie riveteertang 3 in 1

- Voor klinknagels 3,2 tot 6,4mm
- Voor blindklinkmoeren M4, M5, M6, M8 en M10
- Voor blindklinkbouten M4, M5, M6 en M8
- Met 360° draaibare kop.
- Bereikt alle onbereikbare hoekjes.
- Gebreveteerd model.
- Extra zware uitvoering.
- Met 2 extra lange hendels voor een prima krachtoverbrenging.

Geleverd in een handige kunststof opbergkoffer.

Accessoires los leverbaar.

Order nr.	727819700		
Orig. nr.	RITC970		
Capaciteit blindklinknagels in aluminium	mm	3,2 - 4,0 - 4,8 - 6,4	
Capaciteit blindklinkmoeren in aluminium	M	4 - 5 - 6 - 8 - 10	
Capaciteit blindklinkbouten in aluminium	M	4 - 5 - 6 - 8	
Prijs	€	95,50	



Pneumatische riveteertang voor blindklinknagels.

- Basismodel.
- Cap. 2,4 tot 4,8mm.
- Een professioneel toestel voor seriematig werk.

Order nr.	727814800		
Orig. nr.	RITC480		
Capaciteit blindklinknagels in aluminium	mm	2,4 - 3,2 - 4,0 - 4,8	
Werkdruk	bar	5,5-7	
Consommation d'air/rivet	l	0,8	
Koers	mm	16	
Prijs	€	144,00	



Pneumatische riveteertang voor blindklinknagels.

Kenmerken:

- Cap. 3,2 tot 6,4mm
- Een professioneel toestel voor seriematig werk.

Order nr.	727816400		
Orig. nr.	RITC640		
Capaciteit blindklinknagels in aluminium	mm	3,2 - 4,0 - 4,8 - 6,4	
Werkdruk	bar	6-8	
Consommation d'air/rivet	l	0,9	
Koers	mm	19	
Met 360° draaiende kop		nee	
Prijs	€	183,00	



Pneumatische riveteertang voor blindklinknagels.

Kenmerken:

- Basismodel.
- Cap. 2,4 tot 4,8mm.
- Een professioneel toestel voor seriematig werk.
- Met 360° draaibare kop.

Order nr.	727814810		
Orig. nr.	RITC480S		
Capaciteit blindklinknagels in aluminium	mm	2,4 - 3,2 - 4,0 - 4,8	
Werkdruk	bar	6-8	
Consommation d'air/rivet	l	0,8	
Koers	mm	16	
Prijs	€	230,00	

Accessoires riveteertangen



Verzinkte blindklinkmoeren (BKM) voor universeel gebruik.

- Materiaalsterkte : 8.8.
- VE = verpakkingseenheid.
- Kunnen bevestigd worden met onze tangen uit het gamma NCG.

Order nr.	Orig. nr.	Type	Maat	Diameter mm	Boor mm	Plaatdikte mm	Prijs €
747801004	RIALU4MM	BKM	M4	5,9	6	0,5-3,0	20,50
747801005	RIALU5MM	BKM	M5	6,9	7	0,3-3,0	22,90
747801006	RIALU6MM	BKM	M6	8,9	9	0,3-3,0	25,90
747801008	RIALU8MM	BKM	M8	10,9	11	0,5-3,0	18,50
747801010	RIALU10MM	BKM	M10	11,9	12	0,5-3,0	22,90



Multigrip blindklinknagels Alu/st.

- Deze nagels hebben een breder klembereik, waardoor de voorbereiding minder exact dient te zijn.
- Een bijkomend voordeel van het breder klembereik is de betere afdichting.

Order nr.	Orig. nr.	Maat mm	VE	Prijs/VE €
747809320	RIBLU3210	3,2x10	200	9,60
747809408	RIBLU4008	4,0x8	200	10,90
747809410	RIBLU4010	4,0x10	200	11,90
747809412	RIBLU4012	4,0x12	200	7,30
747809481	RIBLU4810	4,8x10	200	8,00
747809482	RIBLU4812	4,8x12	200	8,50



Verzinkte stalen blindklinkbouten (BKB) voor universeel gebruik.

- Materiaalsterkte : 8.8.
- VE = verpakkingseenheid.
- Kunnen bevestigd worden met onze tangen uit het gamma NCG.

Order nr.	Orig. nr.	Type	Maat	Draadlengte mm	Boor mm	Plaatdikte mm	Prijs €
747802040	RIBKBM4	BKB	M4	15	5,5	0,5-2,0	22,90
747802050	RIBKBM5	BKB	M5	15	6,6	0,5-2,0	25,90
747802060	RIBKBM6	BKB	M6	20	7,8	0,5-2,5	27,50
747802080	RIBKBM8	BKB	M8	20	9,9	1,0-3,0	50,50

WISSELSTUKKEN RIVETEERTANGEN OP VYNCKIER.BIZ



Assortiment blinklinknagels, -moeren en/of -bouten in een handige navulbare kunststof koffer.

RISSET900

assortiment 900 multigrip blindklinknagels/900 rivets alu/st

- 200 st/pc 3,2x10mm
- 200 st/pc 4.0x8mm
- 200 st/pc 4.0x10mm
- 100 st/pc 4.0x12mm
- 100 st/pc 4.8x10mm
- 100 st/pc 4.8x12mm

RISSET400

assortiment 400 blindnietmoeren /400 rivets creux:

- 100 st/pc M4
- 100 st/pc M5
- 100 st/pc M6
- 50 st/pc M8
- 50 st/pc M10

RISSET500

assortiment 400 blindnietmoeren /400 rivets creux:

- 100 st/pc M4
- 100 st/pc M5
- 100 st/pc M6
- 50 st/pc M8
- 50 st/pc M10
- assortiment 100 blindnietbouten/100 rivets goujons alu:
- 25 st/pc M4
- 25 st/pc M5
- 25 st/pc M6
- 25 st/pc M8

Order nr.	747804001	747805001	747809001
Orig. nr.	RISSET400	RISSET500	RISSET900
Aantal blindklinknagels 3,2 x 10mm			200
Aantal blindklinknagels 4,0 x 8mm			200
Aantal blindklinknagels 4,0 x 10mm			200
Aantal blindklinknagels 4,0 x 12mm			100
Aantal blindklinknagels 4,8 x 10mm			100
Aantal blindklinknagels 4,8 x 12mm			100
Aantal blindklinkmoeren M4	100	100	
Aantal blindklinkmoeren M5	100	100	
Aantal blindklinkmoeren M6	100	100	
Aantal blindklinkmoeren M8	50	50	
Aantal blindklinkmoeren M10	50	50	
Aantal blindklinkbouten M4			25
Aantal blindklinkbouten M5			25
Aantal blindklinkbouten M6			25
Aantal blindklinkbouten M8			25
Prijs	€ 71,50	130,00	53,50

Poulietrekkers

TENGOOLS



4-delige set.

Bestaande uit:

- 1 combinatie-poulietrekker met 3 armen.

Kenmerken:

- Met de mogelijkheid om de poulietrekker zowel als 2-armig of als 3-armig toestel te gebruiken.
- Met omkeerbare armen voor intern en extern trekken.
- TC-tray.

Order nr.	03980109	
Orig. nr.	TT804	
Vastklemdiepte	mm	100
Vastklembreedte	mm	130
Prijs	€	39,50

IZELTAS



Poulietrekker. "Master" model. 2-armig model. Vervaardigd uit chroom vanadium staal. Verzinkt. Geharde armen. Inductie geharde spindel.

Order nr.	Orig. nr.	Capaciteit	Maximum diameter	Maximum hoogte	Prijs
		mm	mm	mm	€
770108010	IZ7010320810	08x10	80	100	68,90
770101210	IZ7010321210	12x10	120	100	74,90
770101615	IZ7010321615	16x15	160	150	121,00
770102015	IZ7010322015	20x15	200	150	132,00
770102520	IZ7010322520	25x20	250	200	281,00
770105220	IZ7010325220	52x20	520	200	615,00

IZELTAS



Stand voor type IZ 7010-poulietrekkers. Verkrijgbaar als lege stand of als gevulde stand.

Order nr.	770109999	770106105
Orig. nr.	IZ7010206105	IZ7010006105
Omschrijving	lege stand	gevulde stand
Prijs	€ 11,90	659,00

TENGOOLS

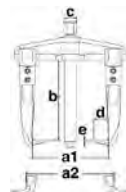

Poulietrekker. Klassiek Europees 2-armig model. Chroom vanadium staal. Inductiegeharte spindel. Matverchroomd. Zowel binnen- als buitentrekker.

Order nr.	Orig. nr.	Interne klemming (a1)	Externe klemming (a2)	Diepte klemming (b)	Schroefdraad spindel	Lengte spindel	Prijs
		mm	mm	mm		mm	€
143930105	SP1410	90	133	97	M14x1,5	140	53,90
143930204	SP1810	130	170	97	M14x1,5	140	55,90
143930303	SP2215	158	209	150	M20x2	210	90,90
143930402	SP2615	200	256	150	M20x2	210	104,00
143930501	SP3320	250	325	205	M26x2	220	180,00

TENGOOLS



5-delige set bestaande uit display gevuld met poulietrekkers in verschillende maten. De Poulietrekkers zijn regelbaar voor intern en extern trekken.

Order nr.	144740107	
Orig. nr.	DIS-SP05	
Poulietrekkers	SP1410 · SP1810 · SP2215 · SP2615 · SP3320	
Prijs	€	509,00

TENGOOLS



5-delige set bestaande uit display gevuld met poulietrekkers in verschillende maten. De Poulietrekkers zijn regelbaar voor intern en extern trekken met quick-action aanpassing.

Order nr.	178761003	
Orig. nr.	DIS-SP05Q	
Poulietrekkers	SP1410Q · SP1810Q · SP2215Q · SP2615Q · SP3320Q	
Prijs	€	455,00

TENGILOOS

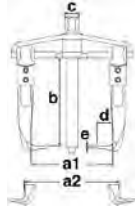

Poulietrekker. Klassiek Europees 2-armig model met Quick-action aanpassing. Chroom vanadium staal. Inductiegeharde spindel. Matverchroomd. Zowel binnen- als buitentrekker.

Order nr.	Orig. nr.	Interne klemming (a1)	Externe klemming (a2)	Diepte klemming (b)	Schroefdraad spindel	Lengte spindel	Prijs
		mm	mm	mm		mm	€
178760104	SP1410Q	90	133	97	M14x1,5	140	72,50
178760203	SP1810Q	130	170	97	M14x1,5	140	77,50
178760302	SP2215Q	158	209	150	M20x2	210	113,00
178760401	SP2615Q	200	256	150	M20x2	210	127,00
178760500	SP3320Q	250	325	205	M26x2	220	179,00

IZELTAS



Poulietrekker. Master model. 3-armig model. Vervaardigd uit chroom vanadium staal. Verzinkt. Geharde armen. Inductie geharde spindel.

Order nr.	770203720	770205220
Orig. nr.	IZ7020323720	IZ7020325220
Capaciteit	mm 37x20	52x20
Maximum diameter	mm 370	520
Maximum hoogte	mm 200	200
Prijs	€ 625,00	849,00

IZELTAS



Poulietrekker. "Battery" model. 2-armig. Met T-vormig hendel. Vervaardigd uit chroom vanadium staal. Verzinkt. Geharde armen. Inductie geharde spindel.

Order nr.	770506060	770508080
Orig. nr.	IZ7050320606	IZ7050320808
Breedte	mm 60	80
Hoogte	mm 60	80
Prijs	€ 29,90	31,90

IZELTAS



Poulietrekker. "Battery" model. 3-armig. Met T-vormig hendel. Vervaardigd uit chroom vanadium staal. Verzinkt. Geharde armen. Inductie geharde spindel.

Order nr.	Orig. nr.	Capaciteit	Maximum diameter	Maximum hoogte	Prijs
		mm	mm	mm	€
770604060	IZ7060320406	06x04	60	40	38,50
770606060	IZ7060320606	06x06	60	60	39,50
770608080	IZ7060320808	08x08	80	80	40,50

IZELTAS



Poulietrekker. Standaard model. 2-armig model. Vervaardigd uit chroom vanadium staal. Verzinkt. Geharde armen. Inductie geharde spindel.

Order nr.	Orig. nr.	Capaciteit	Maximum diameter	Maximum hoogte	Prijs
		mm	mm	mm	€
770308080	IZ7030320808	08x08	80	80	28,90
770301212	IZ7030321212	12x12	120	120	56,90
770301616	IZ7030321616	16x16	160	160	83,90

IZELTAS



Poulietrekker. Standaard model. 3-armig model. Vervaardigd uit chroom vanadium staal. Verzinkt. Geharde armen. Inductie geharde spindel.

Order nr.	770408080	770401212	770401616	770402320
Orig. nr.	IZ7040320808	IZ7040321212	IZ7040321616	IZ7040322320
Capaciteit	mm 08x08	12x12	16x16	23x20
Maximum diameter	mm 80	120	160	160
Maximum hoogte	mm 80	120	160	195
Prijs	€ 52,50	77,50	114,00	168,00

TOOLS

IZELTAS



Poulietrekker. S-vormig model. 2-armig. Vervaardigd uit chroom vanadium staal. Verzinkt. Geharde armen. Inductie geharde spindel.

Order nr.	770702013		
Orig. nr.	IZ7070322013		
Capaciteit	mm	20x13	
Maximum diameter	mm	200	
Maximum hoogte	mm	130	
Prijs	€	79,50	

IZELTAS



Poulietrekker. S-vormig model. 3-armig. Vervaardigd uit chroom vanadium staal. Verzinkt. Geharde armen. Inductie geharde spindel.

Order nr.	770802013		
Orig. nr.	IZ7080322013		
Capaciteit	mm	20x13	
Maximum diameter	mm	200	
Maximum hoogte	mm	130	
Prijs	€	108,00	

IZELTAS



Poulietrekker. Universeel model. 2-armig. Vervaardigd uit chroom vanadium staal. Verzinkt. Geharde armen. Inductie geharde spindel.

Order nr.	770902222		
Orig. nr.	IZ7090322222		
Capaciteit	mm	22x22	
Maximum diameter	mm	220	
Maximum hoogte	mm	220	
Prijs	€	94,50	

IZELTAS



Poulietrekker. Universeel model. 3-armig. Vervaardigd uit chroom vanadium staal. Verzinkt. Geharde armen. Inductie geharde spindel.

Order nr.	771002222		
Orig. nr.	IZ7100322222		
Capaciteit	mm	22x22	
Maximum diameter	mm	220	
Maximum hoogte	mm	220	
Prijs	€	123,00	

TENGTTOOLS



3-armige poulietrekker. Combi-model. Model met de mogelijk om ofwel met 2 ofwel met 3 armen te werken. chroom vanadium staal. Gesmeed en gehard. Inductiegeharde spindel.

Order nr.	131910101	128420106
Orig. nr.	SP11	SP22
Reikwijdte	mm 76-102	78-178
Maximum bereik	mm 89	137
Prijs	€ 52,90	99,90

TENGTTOOLS

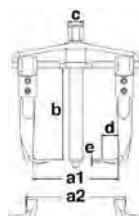

Poulietrekker. Klassiek Europees 3-armig model. Chroom vanadium staal. Inductiegeharde spindel. Matverchromd. Zowel binnen- als buitentrekker.

Order nr.	Orig. nr.	Interne klemming (a1) mm	Externe klemming (a2) mm	Diepte klemming (b) mm	Schroef-draad spindel	Lengte spindel mm	Prijs €
178770103	SP31410	90	133	97	M14x1,5	140	84,50
178770202	SP31810	130	170	97	M14x1,5	140	88,50
178770301	SP32215	160	211	150	M20x2	210	124,00
178770400	SP32615	205	261	150	M20x2	210	132,00
178770509	SP33320	252	327	205	M26x2	220	196,00

TENGTTOOLS

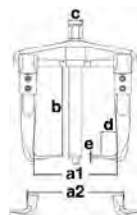

Poulietrekker. Klassiek Europees 3-armig model met quick-action aanpassing. Chroom vanadium staal. Inductiegeharde spindel. Matverchromd. Zowel binnen- als buitentrekker.

Order nr.	Orig. nr.	Interne klemming (a1) mm	Externe klemming (a2) mm	Diepte klemming (b) mm	Schroef-draad spindel	Lengte spindel mm	Prijs €
178780102	SP31410Q	90	133	97	M14x1,5	140	97,90
178780201	SP31810Q	130	170	97	M14x1,5	140	102,00
178780300	SP32215Q	160	211	150	M20x2	210	140,00
178780409	SP32615Q	205	261	150	M20x2	210	176,00
178780607	SP33320Q	252	327	205	M26x2	220	212,00

MEER ACCESSOIRES
OP VYNCKIER.BIZ

TENGOOLS



Poulietrekker met 3 armen, met speciaal systeem om met 2 of 3 armen te trekken.

Order nr.	237870100	237870209
Orig. nr.	SPA11	SPA22
Vastklemdiepte	mm 100	170
Vastklembreedte	mm 50-100	60-150
Prijs	€ 33,70	56,10

Wisselstukken poulietrekkers

IZELTAS



Koppelstuk voor verlengstukken voor poulietrekker IZ7010 types.

Order nr.	770102033	770103033	770104033
Orig. nr.	IZ7010322033	IZ7010323033	IZ7010324033
Voor	mm 8x10 10x12	16x15 20x15 25x20 35x20	37x20 52x20 65x20
Capaciteit	mm 08x08	12x12	16x16
Prijs	€ 23,50	26,90	57,90

IZELTAS



Koppelstukken voor poulietrekker IZ7010 types.

Order nr.	Orig. nr.	Voor mm	Prijs €
770108033	IZ7010600833	8x10 10x12	8,70
770101633	IZ7010601633	16x15 20x15 25x20 35x20	14,50
770102533	IZ7010602533	37x20 52x20 65x20	26,90

IZELTAS



Vervangarmen voor poulietrekker IZ7010 types.

Order nr.	Orig. nr.	Voor mm	Prijs €
770108022	IZ7010600822	8x10 10x12	17,50
770101622	IZ7010601622	16x15 20x15 25x20 35x20	29,90
770102522	IZ7010602522	37x20 52x20 65x20	50,50

IZELTAS



Vervangspindel voor poulietrekker IZ7010 types.

Order nr.	Orig. nr.	Maat	Voor mm	Prijs €
770108440	IZ7010100844	M14X1.5	8x10 - 12x10	15,90
770101644	IZ7010101644	M20X2.0	16x15 - 20x15	28,50
770102544	IZ7010102544	M27X2.0	25x20	50,50
770103544	IZ7010103544	M33X2.0	35x20 - 37x20	65,90
770105244	IZ7010105244	M39X2.0	52x20	66,90

IZELTAS



Vervangarmen voor poulietrekkers IZ7030 types.

Order nr.	Orig. nr.	Voor mm	Prijs €
770308022	IZ7030600822	08x08	12,90
770301222	IZ7030601222	12x12	13,90
770301622	IZ7030601622	16x16	23,50
770302333	IZ7030602332	23x20	31,90

IZELTAS



Vervangspindel voor poulietrekkers IZ7030 types.

Order nr.	Orig. nr.	Maat	Voor mm	Prijs €
770308044	IZ7030100844	M12X1.5	08x08	12,90
770301244	IZ7030101244	M14X1.5	12x12	18,50
770301644	IZ7030101644	M18X2	16x16	20,50
770302344	IZ7030102344	M22X2	23x20	28,90

IZELTAS



Vervangarmen voor poulietrekkers IZ7050 en IZ7060 types.

Order nr.	Orig. nr.	Voor mm	Prijs €
770504022	IZ7050600422	06x04	7,40
770506022	IZ7050600622	06x06	9,10
770508022	IZ7050600822	08x08	9,10

IZELTAS



Vervangspindel voor poulietrekkers IZ7050 en IZ7060 types.

Order nr.	Orig. nr.	Voor mm	Prijs €
770504044	IZ7050100444	06x04	9,10
770506044	IZ7050100644	06x06	9,10
770508044	IZ7050100844	08x08	11,90

TOOLS



TENG TOOLS

ALL THE TOOLS YOU NEED

Get organised™



**IN THE SHOP
ALL GUARANTEED!**



Aambeelden

unicraft



Aambeeld uit gelegeerd staal.

Kenmerken:

- Met ronde hoorn en hoekige hoorn
- Voet gegoten uit 1 stuk
- Gehard en geslepen bovenvlak
- Met vierkant gat en rond gat voor aambeeldgereedschap

Order nr.	716351025	716351050	716351100
	E	E	E
Orig. nr.	6351025	6351050	6351100
Oppervlak geslepen vlak (zonder hoorn)	mm 142x110	175x130	228x169
Lengte hoekige hoorn	mm 170	200	260
Lengte ronde hoorn	mm 150	199	259
Diameter rond gat	mm 18	18	23
Afmetingen vierkant gat	mm 17x17	20x20	26x26
Afmetingen voet (l x b)	mm 175x145	210x165	273x214
Gewicht	kg 25,00	50,00	100,00
Afmetingen (l x b x h)	mm 462 x 145	574 x 165	747 x 214
		x 150	x 195
Prijs	€ 149,00	315,00	669,00

TOOLS



Aambeeld.

- In niet-gehard gietstaal met geslepen bovenvlak.
- Afmetingen werkvlak 310 mm x 113 mm.
- Met 1 hoorn.
- Lengte hoorn 180 mm.

Order nr.	724557575
Orig. nr.	GR75AB
Gewicht	kg 75,00
Prijs	€ 263,00

Beitels

TENGTTOOLS



Speciaal staal verchroomd. Platte beitel. Inductiegehard.

Order nr.	117020909	117021006	117021105
Orig. nr.	CC150F	CC200F	CC250F
Maat	mm 19	25	25
Omschrijving	platte beitel	platte beitel	platte beitel
Prijs	€ 8,20	13,50	16,50

IZELTAS



Platte beitel DIN 6453. Speciaal staal. Verchroomd.

Order nr.	755002000	755002500	755003000
Orig. nr.	I25500400200	I25500400250	I25500400300
Breedte top	mm 26	29	29
Prijs	€ 7,60	10,50	11,90

IZELTAS



Metaalbeitel DIN6453. Speciaal staal. Verchroomd. Met veiligheidshandvat.

Order nr.	755009250	755009300
Orig. nr.	I25500470250	I25500470300
Breedte top	mm 29	29
Prijs	€ 19,50	20,50

TENGTTOOLS



NEW

4 delige houtbeitelset.

Kenmerken:

- Met transparante lak coating voor bescherming tegen corrosie
- Schokbestendig soft grip handvat
- Elk blad voorzien van een kunststof beschermhoes

Order nr.	231861303
Orig. nr.	WCS04L
Maat	mm 6-12-18-25
Prijs	€ 31,00

TENGTTOOLS



NEW

4 delige houtbeitelset.

Kenmerken:

- Met transparante lak coating voor bescherming tegen corrosie
- Schokbestendig soft grip handvat
- Elk blad voorzien van een kunststof beschermhoes

Order nr.	231861402
Orig. nr.	WCS04S
Maat	mm 10-16-18-20
Prijs	€ 31,00

TENGOOLS



NEW

5 delige set centerpunten en beitel uit gehard speciaal staal. Cilindrisch. Met schokbestendige kop en achthoekige schacht. Geleverd in een kunststof houder.

Order nr.	237860101		
Orig. nr.	PCX05		
Centerpunten	mm	3x150 - 4x150- 2x 5x150	
Platte beitel	mm	18x150	
Prijs	€	18,80	

TENGOOLS



NEW

7 delige houtbeitelset op muurrek.

Kenmerken:

- Met transparante lak coating voor bescherming tegen corrosie
- Schokbestendig soft grip handvat
- Elk blad voorzien van een kunststof beschermhoes

Order nr.	231861501		
Orig. nr.	WRWC07		
Maat	mm	6-10-12-16-18-20-25	
Prijs	€	62,10	

TENGOOLS



NEW

9-delige beitel- en doorslagenset. TC-tray.

Bestaande uit:

- 2 beitels L. 150 en 200mm
- 6 doorslagen diam. 3 tot 8mm
- 1 centerpunt L. 150mm

Order nr.	69220101		
Orig. nr.	TIPC09		
Top diameter doorslagen	mm	3 - 4 - 5 - 6 - 7 - 8	
Breedte beitels	mm	19 - 25	
Punt diameter centerdoorslag	mm	5	
Afmetingen (l x b x h)	mm	270 x 143 x 50	
Prijs	€	41,90	

TENGOOLS



NEW

Houtbeitel.

Kenmerken:

- Met transparante lak coating voor bescherming tegen corrosie
- Schokbestendig soft grip handvat
- Blad voorzien van een kunststof beschermhoes

Order nr.	Orig. nr.	Breedte blad mm	Totale lengte mm	Prijs €
231860107	WCC06	6	275,6	12,10
231860206	WCC08	8	275,6	12,10
231860305	WCC10	10	275,6	12,10
231860404	WCC12	12	275,6	12,10
231860503	WCC14	14	275,6	12,10
231860602	WCC16	16	275,6	12,10
231860701	WCC18	18	275,6	12,40
231860800	WCC20	20	275,6	12,90
231860909	WCC22	22	275,6	13,00
231861006	WCC25	25	280,5	13,00
231861105	WCC32	32	290,5	14,30
231861204	WCC38	38	304,5	15,30

Doorslagen

TENGOOLS



Set van 6 doorslagen diam. 3 mm tot 8 mm. Speciaal staal. Inductiegehard. Verchroomd. Met speciaal geharde kop. Geleverd in handige kunststof houder.

Order nr.	69110104		
Orig. nr.	PPS06		
Lengte	mm	150	
Diameter top	mm	3 - 4 - 5 - 6 - 7 - 8	
Prijs	€	29,90	

TENGOOLS



Cilindrische doorslagen. Speciaal staal. Inductiegehard. Verchroomd. Met speciaal geharde kop.

Order nr.	Orig. nr.	Maat mm	Lengte mm	Prijs €
117020107	PP03	3	150	4,70
117020206	PP04	4	150	4,70
117020305	PP05	5	150	4,70
117020404	PP06	6	150	4,70
117020503	PP07	7	150	5,80
117020602	PP08	8	150	5,80

TENGOOLS



Centerpunt. Speciaal staal. Inductiegehard. Verchroomd. Met speciaal geharde kop.

Order nr.	117021204		
Orig. nr.	CP05		
Maat	mm	5	
Lengte	mm	150	
Prijs	€	5,50	

TENGOOLS



Automatisch centerpunt 135 mm met pocket clip.

Order nr.	122260102
Orig. nr.	SCP01
Lengte	mm 135
Prijs	€ 13,50

TENGOOLS



10-delig beitelen en doorslagenset.

Bestaat uit:

- Doorslagen 3,4,5,6,7,8, mm
- Koudbeitels 18x150, 25x200, 25x250
- Centerpunt 5 mm
- wandrek

Order nr.	199810102
Orig. nr.	WRPC10
Top diameter doorslagen	mm 3 - 4 - 5 - 6 - 7 - 8
Breedte beitels	mm 18 - 25
Punt diameter centerdoorslag	mm 5
Prijs	€ 53,90

Hamers

TENGOOLS



Bankhamer DIN 1040. Kunststof steel.

Order nr.	Orig. nr.	Lengte mm	Gewicht kg	Prijs €
117030106	HMEG300	300	0,42	12,90
117030205	HMEG500	320	0,65	15,50
117030304	HMEG800	350	0,80	19,50

TENGOOLS



Herstelkit: kunststof steel en wig voor HMEG.

Order nr.	Orig. nr.	Voor	Gewicht kg	Prijs €
117031005	HMEG300RK	HMEG300	0,10	10,40
117031104	HMEG500RK	HMEG500	0,13	12,90
117031203	HMEG800RK	HMEG800	0,15	13,70

TENGOOLS



Bolkophamer. Engels model. Steel in kunststof.

Order nr.	Orig. nr.	Gewicht kg	Prijs €
105880058	HMBP12	0,48	14,90
105880108	HMBP16	0,68	16,90
105880207	HMBP24	0,98	22,90
105880306	HMBP32	1,28	22,90

TENGOOLS



Herstelkit: steel + wig voor HMBP.

Order nr.	Orig. nr.	Voor	Gewicht kg	Prijs €
105881106	HMBP12RK	herstelkit: steel + wig voor HMBP12	0,11	11,60
105881205	HMBP16RK	herstelkit: steel + wig voor HMBP16	0,17	13,70
105881304	HMBP24RK	herstelkit: steel + wig voor HMBP24	0,20	16,80
105881403	HMBP32RK	herstelkit: steel + wig voor HMBP32	0,24	17,60



Bankhamer DIN 1040. IZ-type: steel in hickory.

Order nr.	709000029	709000032
Orig. nr.	IZ5800240200	IZ5800242000
Lengte	mm 300	400
Gewicht van de kop	g 200	2000
Gewicht	kg 0,26	2,10
Prijs	€ 12,90	46,50



Klauwhamer.

Kenmerken:

- Ronde baan en achthoekig kop
- Chroom, ovaal stalen handvat met grip uit geperforeerde rubber
- Ophanggat aan het uiteinde van het handvat, om de val van de hamer te voorkomen bij werken op hoogte

Order nr.	231840109	231840208	231840406
Orig. nr.	HMCH08A	HMCH13A	HMCH20A
Diameter baan	mm 21,6	27	30
Gewicht van de kop	g 227	368	567
Totale lengte	mm 290	335	340
Gewicht	kg 0,39	0,55	0,77
Prijs	€ 16,70	18,50	22,70



Klauwhamer.

Kenmerken:

- Ronde baan en achthoekig kop
- Chroom, ovaal stalen handvat met grip uit geperforeerde rubber
- Gesmeed kop met magnetische spijkerhouder
- Ophanggat aan het uiteinde van het handvat, om de val van de hamer te voorkomen bij werken op hoogte

Order nr.	231840505
Orig. nr.	HMCH16M
Diameter baan	mm 27,5
Gewicht van de kop	g 454
Totale lengte	mm 341
Gewicht	kg 0,68
Prijs	€ 23,10



Klauwhamer.

Kenmerken:

- Stalen hamer in een stuk gesmeed, met schokdempend handvat
- Gesmeed kop met magnetische spijkerhouder
- Ophanggat aan het uiteinde van het handvat, om de val van de hamer te voorkomen bij werken op hoogte

Order nr.	237920103
Orig. nr.	HMCHM16
Diameter baan	mm 29
Gewicht van de kop	g 454
Totale lengte	mm 333
Gewicht	kg 0,72
Prijs	€ 40,00



Klauwhamer.

Kenmerken:

- Koolstofvezel, voor 25% meer flexibiliteit dan glasvezel
- Ronde baan
- Ophanggat aan het uiteinde van het handvat, om de val van de hamer te voorkomen bij werken op hoogte

Order nr.	231850207
Orig. nr.	HMCHC16
Diameter baan	mm 28
Gewicht van de kop	g 454
Totale lengte	mm 327
Gewicht	kg 0,69
Prijs	€ 24,90



Klauwhamer. Chroom, ovaal stalen handvat bekleed met rubber.

Order nr.	116990201
Orig. nr.	HMCH16A
Lengte	mm 312
Gewicht	kg 0,70
Prijs	€ 18,90

TENGOOLS



Metselhamer.

Kenmerken:

- Ideaal voor het snijden van bakstenen, steen of metselwerk
- Ophanggat aan het uiteinde van het handvat, om de val van de hamer te voorkomen bij werken op hoogte

Order nr.	231850108 ⓘ	
Orig. nr.	HMBH16	
Diameter baan	mm	23
Gewicht van de kop	g	454
Totale lengte	mm	291
Gewicht	kg	0,73
Prijs	€	24,20

TENGOOLS



Mokerhamer uit carbon.

Ophanggat aan het uiteinde van het handvat, om de val van de hamer te voorkomen bij werken op hoogte.

Order nr.	231870106 ⓘ	
Orig. nr.	HMS1250	
Diameter baan	mm	43
Gewicht van de kop	g	1250
Totale lengte	mm	296
Gewicht	kg	1,61
Prijs	€	33,20

TENGOOLS



7-delige uitdeukset bestaande uit de 4 meeste gebruikte tassen en 3 plaatsslagerhamers, alle met een glasvezelsteel. Verpakt in een handige kunststof koffer.

Order nr.	754751001 ⓘ	
Orig. nr.	CAL51001AA	
Gewicht	kg	1,00
Prijs	€	28,90

TENGOOLS



5-delige hamerset. PS-tray.

Bestaande uit:

- 2 terugslagvrije hamers
- 3 plaatwerkhamers.

Geleverd in een PVC tray.

Order nr.	122440100 ⓘ	
Orig. nr.	TTPSAD	
Diameter kop van terugslagvrije hamers	mm	35 & 55
Plaatwerkhamer	met rechte pin, met ronde puntige kop, met vierkante kop	
Gewicht	kg	5,76
Prijs	€	105,00

TENGOOLS



Plaatslagershamer. Prima kwaliteit met hickory-houten handvat. Model met 1 ronde, rechte, platte kop en 1 rechte punt.

Order nr.	117900100 ⓘ	
Orig. nr.	HMBH01	
Lengte	mm	325
Gewicht	kg	0,43
Prijs	€	23,90

TENGOOLS



Plaatslagershamer. Prima kwaliteit met hickory-houten handvat. Model met 1 ronde, rechte, platte kop en 1 ronde punt kop.

Order nr.	117900209 ⓘ	
Orig. nr.	HMBH02	
Lengte	mm	325
Gewicht	kg	0,41
Prijs	€	23,90

TENGOOLS



Plaatshamer. Prima kwaliteit met hickory-houten handvat. Model met platte kop.

Order nr.	117900308		
Orig. nr.	HMBH03		
Lengte	mm	325	
Gewicht	kg	0,44	
Prijs	€	30,90	

TENGOOLS



Retourslagvrije hamer. De kop is gevuld met fijne staaldeeltjes om te verhinderen dat de hamer terugkaatst bij het slaan. Zwarte uitvoering.

Order nr.	Orig. nr.	Gewicht van de kop	Gewicht	Prijs
		g	kg	€
117870105	HMDH35	35	0,30	18,50
186360103	HMDH45	45	0,50	25,90
117870204	HMDH55	55	0,98	30,50
186360202	HMDH65	65	1,37	39,50

TENGOOLS



Hammer met nylon kop en rubber kop. Ronde, stalen steel met geperforeerd rubber handvat.

Order nr.	105810105		
Orig. nr.	HMSF		
Diameter kop	mm		
Gewicht	kg	0,67	
Prijs	€	25,50	

TENGOOLS



Set extra koppen voor HMSF.

Order nr.	105810204		
Orig. nr.	HMSFRK		
Gewicht	kg	0,04	
Prijs	€	9,40	

IZELTAS



Hamer volrubber kop. Ronde stalen steel met geperforeerd rubber handvat.

Order nr.	758704000		
Orig. nr.	IZ5870000400		
Gewicht van de kop	g	104	
Gewicht	kg	0,67	
Prijs	€	24,90	

Holpijpen

IZELTAS



Holpijpen DIN 7200. Chroom vanadium.

Order nr.	Orig. nr.	Maat	Lengte	Prijs
			mm	€
757003030	IZ5700240003	3	105	5,90
757004040	IZ5700240004	4	105	6,40
757005050	IZ5700240005	5	110	7,10
757006060	IZ5700240006	6	110	7,60
757007070	IZ5700240007	7	115	8,40
757008080	IZ5700240008	8	115	8,90
757009090	IZ5700240009	9	120	9,50
757001010	IZ5700240010	10	120	10,90
757001111	IZ5700240011	11	125	10,50
757001212	IZ5700240012	12	125	12,90
757001313	IZ5700240013	13	130	14,50
757001414	IZ5700240014	14	130	15,90
757001515	IZ5700240015	15	140	13,90
757001616	IZ5700240016	16	135	16,50
757001717	IZ5700240017	17	-	15,90
757001818	IZ5700240018	18	140	20,50
757001919	IZ5700240019	19	145	19,50
757002020	IZ5700240020	20	145	24,50
757002121	IZ5700240021	21	150	21,50
757002222	IZ5700240022	22	150	22,50
757002323	IZ5700240023	23	160	23,90
757002424	IZ5700240024	24	160	25,50
757002525	IZ5700240025	25	170	30,90
757002626	IZ5700240026	26	170	27,90
757002727	IZ5700240027	27	180	28,90
757002828	IZ5700240028	28	180	46,50

IZELTAS



Set holpijpen gaande van diameter 3 tot 14 mm.

Order nr.	757002110	757002112
Orig. nr.	IZ5700242110	IZ5700242112
Aantal stuks	10	12
Holpijpen	mm	3-12
		3-14
Prijs	€	71,90
		95,90

Koevoeten

TENGOOLS



Set van 3 priemen voorzien van een stevig handvat.

Kenmerken:

- Universeel toepasbaar.
- TTX-tray.

Order nr.	117860106
Orig. nr.	TTXPB3A
Lengte	mm 300 - 450 - 550
Prijs	€ 36,90

TENGOOLS



Extra zware priem - koevoet met zware chroom vanadium schacht en kunststof handvat. Met platte gespleten v-top. Lengte 300mm.

Order nr.	118110105
Orig. nr.	PB12A
Lengte	mm 300
Prijs	€ 9,90

TENGOOLS



Extra zware priem - koevoet met zware chroom vanadium schacht en kunststof handvat. Met gebogen platte top. Lengte 450mm.

Order nr.	118110204
Orig. nr.	PB18A
Lengte	mm 450
Prijs	€ 14,90

TENGOOLS



Extra zware priem - koevoet met zware chroom vanadium schacht en kunststof handvat. Met platte top. Lengte 550mm.

Order nr.	118110303
Orig. nr.	PB22A
Lengte	mm 550
Prijs	€ 17,50



Vierkante kop en achthoekige greep.

Order nr.	212240105	212240204
Orig. nr.	212240105	212240204
Lengte	mm 1200	1500
Prijs	€ 39,50	46,50

TENGOOLS



Set van 3 koevoeten. TTX-tray.

Kenmerken:

- Koevoeten van verschillende lengtes en met een ronde, spitse punt aan het ene eind en een vlakke ronde haak aan het andere einde.

Order nr.	100690106
Orig. nr.	TTXPB3
Lengte	mm 300 - 400 - 500
Prijs	€ 50,50

TENGOOLS



Koevoet met een ronde, spitse punt aan het ene eind en een vlakke ronde haak aan het andere einde. Speciaal gehard staal. Matverchromd.

Order nr.	116980103	116980202	116980301
Orig. nr.	PB12	PB16	PB20
Lengte	mm 300	400	500
Prijs	€ 14,50	19,50	31,90

TENGOOLS



Koevoet. Medium carbon steel. HRC 40 ±2°.

Order nr.	Orig. nr.	Lengte mm	Prijs €
151540101	AT20512	304	12,50
151540200	AT20516	406	19,90
151540309	AT20520	508	23,50
151540408	AT20524	609	32,50

IZELTAS



Koevoet plat model. Gehard en getemperd chroom vanadium staal. Matverchromd.

Order nr.	Orig. nr.	Lengte mm	Prijs €
763504000	IZ6350400400	400	14,90
763505000	IZ6350400500	500	19,50
763506000	IZ6350400600	600	22,90

IZELTAS



Koevoet plat model met gebogen top. Gehard en getemperd chroom vanadium staal. Matverchromd.

Order nr.	763606000 ⓘ	
Orig. nr.	IZ6360400600	
Lengte	mm	600
Prijs	€	24,90



Koevoet.

Order nr.	212140107 ⓘ	212140206 ⓘ
Orig. nr.	212140107	212140206
Lengte	mm	750
Diameter	mm	16
Prijs	€	14,90

Priemen

TENGTOLS



Set bestaande uit 4 haken en pinnen met een aluminium handvat. Zeer algemeen bruikbaar. Ook verkrijgbaar in display.

Order nr.	172260101 ⓘ	
Orig. nr.	TM149	
Prijs	€	12,50

TENGTOLS



4-delige set. TC-tray.

Bestaande uit:

- 1 schraper
- 1 priem
- 2 haken

Met een ergonomisch twee componenten handvat.

Order nr.	117690107 ⓘ	
Orig. nr.	TTSR04	
Prijs	€	25,50

TENGTOLS



Priem. Met rond-haakse top met chroom vanadium schacht. Zwart-grijs ergonomisch twee componenten handvat met ophangopening.

Order nr.	117690305 ⓘ	
Orig. nr.	MDH-S	
Lengte	mm	205
Prijs	€	6,40

TENGTOLS



Priem met rechte chroom vanadium schacht. Zwart-grijs ergonomisch twee componenten handvat met ophangopening. Leverbaar met ofwel ronde ofwel vierkant schacht.

Order nr.	63090104 ⓘ	63090203 ⓘ
Orig. nr.	MDA-R	MDA-SQ
Lengte	mm	220
Ontwerp schacht	rond	vierkant
Lengte schacht	mm	100
Prijs	€	5,90

TENGTOLS



Priem met 90° haakse top met chroom vanadium schacht. Zwart-grijs ergonomisch twee componenten handvat met ophangopening.

Order nr.	117690206 ⓘ	
Orig. nr.	MDHL	
Lengte	mm	245
Prijs	€	5,90

Schrapers

TENGTOLS



Schraper. Met rechte chroom vanadium schacht met 22mm brede platte bek. Zwart-grijs ergonomisch twee componenten handvat met ophangopening.

Order nr.	03130101 ⓘ	
Orig. nr.	MD-SCR	
Lengte	mm	295
Breedte	mm	22
Prijs	€	10,50

TOOLS

TENGTOLSMASTERS.COM

Actief in de autosport, motorsport, motorbootsport,...? Sleutel je vaak aan je wagen, motor, boot, ... om op elke wedstrijd tip-top in orde aan de start te komen? Dan weet je hoe belangrijk goede tools zijn. Dat weten wij ook, en daarom willen wij jouw team sponsoren. Maak keuze uit een selectie van 3 Teng Tools sponsor packs. Bovendien rusten we je team gratis uit met T-shirts, petjes, vlaggen, ...

Naast onze website tengtoolsmasters.com hebben we ook een Facebook-pagina (facebook.com/TengToolsMasters) met nieuws over onze producten, updates over de teams die we sponsoren en leuke wedstrijden met fantastische prijzen. 'Like' ons!





Beugelzagen

TENGTOLS



Zaaghouder in kunststof met anti-slip handvat. Voor 300mm zaagbladen. Kan gebruikt worden als sleutelgat-zaag.

Order nr.	118250109
Orig. nr.	704
Bladlengte	variabel
Prijs	€ 8,00

TENGTOLS



Metaal beugelzaag. L.300mm. In giet-aluminium frame. In het frame is een opbergruimte verwerkt voor een extra zaagblad. Grip-vriendelijk handvat. Geleverd met bi-metaal zaagblad.

Order nr.	74350109
Orig. nr.	701
Frame diepte	mm 390
Lengte zaagblad	mm 300
Almetingen frame	mm 25x12
Prijs	€ 22,50

TENGTOLS



Aluminium beugel met ergonomisch rubberen handgreep. HSS 24 tanden zaagblad. 45/90 graden snijhoek.

Order nr.	186910204
Orig. nr.	701N1
Bladlengte	mm 300
Maximum lengte	mm 395
Prijs	€ 27,90

TENGTOLS



Aluminium beugel met ergonomisch rubberen handgreep. HSS 24 tanden zaagblad. 45/90 graden snijhoek.

Order nr.	186910105
Orig. nr.	701N
Bladlengte	mm 300
Maximum lengte	mm 395
Prijs	€ 28,50

TENGTOLS



Bi-metaal vervangzaagbladen.

Order nr.	74350208
Orig. nr.	702
Lengte zaagblad	mm 300
Aantal	2
Prijs	€ 7,50

TENGTOLS



Junior beugelzaag voor hout, metaal, plastic, enz... Het blad kan worden vastgezet in 6 verschillende posities. Geleverd met 3 zaagbladen.

Order nr.	69360105
Orig. nr.	705
Frame diepte	mm 50
Accessoire	
Bladlengte	mm 150
Prijs	€ 8,80

TENGTOLS



Bi-metaal vervangzaagbladen.

Order nr.	69360204
Orig. nr.	705-5
Lengte zaagblad	mm 150
Aantal	5
Prijs	€ 4,00

TENGTOLS



Schrobzaag met vervangzaagblad voor hout en metaal. Het zaagblad kan vastgezet worden in 4 verschillende posities. Geleverd met 2 zaagbladen - 1 voor hout en 1 voor metaal.

Order nr.	20090106
Orig. nr.	703
Maximum lengte	mm 330
Prijs	€ 18,50

TENGTOLS



Zaagblad voor schrobzaag 703.

Order nr.	20090205	20090304
Orig. nr.	703-10	703-24
Toepassing	hout	metaal
Prijs	€ 5,30	5,30

Breekmessen

TENGOOLS



Set met 5 breekmessen en 35 vervangmessen. TC-tray.

Order nr.	174480103		
Orig. nr.	TTK40		
Afmetingen (l x b x h)	mm	270 x 143 x 50	
Prijs	€	41,90	

TENGOOLS



Universeel mes met intrekbaar mes. Geleverd met 2 mesjes.

Order nr.	105860100		
Orig. nr.	710		
Lengte	mm	160	
Prijs	€	5,70	

TENGOOLS



Universeel mes met intrekbaar mes. Gebruiksvriendelijke rubbergrip. Geleverd met 2 mesjes.

Order nr.	118260108		
Orig. nr.	710N		
Lengte	mm	180	
Prijs	€	10,90	

TENGOOLS



Alu mes - safe auto-return met 6 mesjes.

Order nr.	173220104		
Orig. nr.	711		
Lengte	mm	175	
Prijs	€	16,90	

TENGOOLS



Universeel mes - plooibaar met 3 mesjes.

Order nr.	173220203		
Orig. nr.	712		
Lengte	mm	178	
Prijs	€	18,50	

TENGOOLS



Alu mes - plooibaar mini model 10cm.

Order nr.	173220302		
Orig. nr.	PUKF		
Lengte	mm	98	
Prijs	€	7,10	

TENGOOLS



Breekmes. Met mesbreker en zakclip.

Order nr.	Orig. nr.	Totale lengte mm	Breedte mes mm	Materie	Prijs €
177710100	710A	130	9	metaal	3,40
177710407	710C	160	18	kunststof	3,40
177710209	710F	140	9	kunststof	3,30
177710308	710G	180	18	kunststof, met vastzetschroef	6,70
186880100	710H	125		kunststof	1,60

TENGOOLS



Vervangmessen voor schuifmes 710/710N/711.

Order nr.	105861108	105861207
Orig. nr.	710-10	710-100
Lengte	mm	60
Aantal stuks	10	100
Voor type	710/710N/711/712	710/710N/711/712
Prijs	€	3,90
		26,50

TENGOOLS



Vervangmessen voor schuifmes 710/710N/711.

Order nr.	186890109	186890208
Orig. nr.	710-10H	710-100H
Lengte	mm	50
Aantal stuks	10	100
Voor type	710/710N/711/712	710/710N/711/712
Prijs	€	8,00
		68,90

TENGOOLS



Vervangmessen voor schuifmes 710.

Order nr.	Orig. nr.	Breedte mes mm	Aantal stuks	Voor type	Prijs €
177711009	710A-10	9	10	710A	2,50
177711207	710A-100	9	100	710A/F	19,50
177711108	710F-10	18	10	710C/G	3,40
177711306	710F-100	18	100	710C/G	28,50
105860308	710U-10		10	PUKF	4,40

TENGOOLS



Handontbramer MINI. Met vervangbaar HSS mesje. Het mesblad past zich aan aan de vorm van het werkstuk. Voor buizen, randen, gaten.

Order nr.	173040205		
Orig. nr.	DET02		
Prijs	€	7,10	

TENGOOLS



Ontbraamtoestel met vervangbare HSS messen. Het mesblad past zich aan aan de vorm van het werkstuk. Voor buizen, randen, gaten. Geleverd met 2 messen

Order nr.	173040106
Orig. nr.	DET01
Prijs	€ 11,50

TENGOOLS



2 Extra messen voor DET01.

Order nr.	173041005
Orig. nr.	DET01RK
Prijs	€ 12,50

Boutenscharen

TENGOOLS



Boutenscharen. Geharde snijkanten (HRC55-60). Snijhoek 30°. Zelfcenterende instelling van de messen dankzij de centerbout. Robuuste uitvoering met 2 buisvormige hendels met rubber handgreep.

Order nr.	Orig. nr.	Lengte mm	Capaciteit mm	Capaciteit mm	Lengte inch	Prijs €
101900108	BC414	379	6 (HRC15)	6 (HRC15)	15	31,90
101900207	BC418	485	8 (HRC15)	8 (HRC15)	18	39,50
101900306	BC424	652	10 (HRC15)	10 (HRC15)	24	49,90
101900405	BC430	800	13 (HRC15)	13 (HRC15)	30	67,50
101900504	BC436	958	16 (HRC15)	16 (HRC15)	36	85,50

TENGOOLS



Wisselmessen voor BC-boutenscharen.

Order nr.	Orig. nr.	Lengte mm	Capaciteit mm	Prijs €
101901007	BC414J	379	6	29,30
101901106	BC418J	485	8	40,20
101901205	BC424J	800	10	48,00
101901304	BC430J	800	13	66,20
101901403	BC436J	958	16	87,80

Buizensnijders

TENGOOLS



Buizensnijderset 6-delig.

Bestaat uit:

- buitensnijders voor koper en bronzen buizen 10, 12, 15 en 22mm, 3-22mm
- Ontbraamtoestel

Order nr.	186400107
Orig. nr.	TTC06
Buizensnijder	mm 10 · 12 · 15 · 22
Verstelbare buizensnijder	mm 3-22
Prijs	€ 71,90

TENGOOLS



Buizensnijder voor koper en bronzen buizen. Ideaal voor gebruik in smalle plaatsen.

Order nr.	Orig. nr.	Voor buisdiameter mm	Prijs €
173070103	TFA10	10	14,90
173070202	TFA12	12	15,50
173070301	TFA15	15	16,50
173070400	TFA22	22	18,50

TENGOOLS



5 Extra messen voor TFA10-TFA12-TFA15-TFA22.

Order nr.	173071002
Orig. nr.	TFA0252RK
Prijs	€ 24,60

TENGOOLS



Buizensnijder voor koper en bronzen buizen. Met een dun snijwiel en 2 begeleidingswielen. Intrekbare ruimer.

Order nr.	105910103
Orig. nr.	TF30
Voor buisdiameter	mm 3-32
Prijs	€ 19,50

TENGOOLS



Buizensnijder voor koper en bronzen buizen. Een dun snijwiel en 2 begeleidingswielen. De snijder heeft een constante lengte en is ideaal voor kleine werkomgevingen.

Order nr.	107540106
Orig. nr.	TF22
Voor buisdiameter	mm 3-22
Prijs	€ 9,10

TENGOOLS



Extra snijwielen voor buizensnijder TF30 en TF22.

Order nr.	107540205
Orig. nr.	TF2230RK
Prijs	€ 4,90

TENGOOLS



PVC Buizenontbramer.

Order nr.	173240300
Orig. nr.	DBT41
Voor buisdiameter	mm 3-41
Prijs	€ 8,70

TENGOOLS



Alu Buizenontbramer.

Order nr.	173240102	173240201
Orig. nr.	DBT35	DBT54
Voor buisdiameter	mm 8-35	10-54
Prijs	€ 49,50	59,90

TENGOOLS



Alu buizensnijder voor koper en aluminium.

Order nr.	173250101
Orig. nr.	TF76
Voor buisdiameter	mm 6-76
Prijs	€ 70,90

TENGOOLS



5 extra messen voor TF76.

Order nr.	173251006
Orig. nr.	TF76RK
Prijs	€ 54,00

TENGOOLS



Buizensnijder voor pvc en zacht plastic.

Order nr.	173410101
Orig. nr.	TFP01
Voor maximum buisdiameter	mm 42
Prijs	€ 43,90

TENGOOLS



Extra mes voor TFP01.

Order nr.	173410200
Orig. nr.	TFP01RK
Prijs	€ 18,90

TENGOOLS



Buizensnijder voor pvc.

Order nr.	173410309
Orig. nr.	TFP02
Voor maximum buisdiameter	mm 42
Prijs	€ 44,90

TENGOOLS



Extra mes voor TFP02.

Order nr.	173410408
Orig. nr.	TFP02RK
Prijs	€ 21,50

TENGOOLS



Buizensnijder 19-83mm. Om dunwandige roestvrij staal, koper en PVC-buizen te snijden, tot een dikte van 1.5mm. Zelfsluitend en met éénhandsbediening. De instelmoer zorgt ervoor dat de buizensnijder gemakkelijk kan gebruikt worden voor herhalingsartikelen. 15 snijwielen.

Order nr.	186770103
Orig. nr.	TF300
Buizensnijder	mm 19-83
Prijs	€ 55,50

Kabelscharen

TENGTOLS



Kabelknipper. Matrijsgesmeed. De chroom molydenium staal bladen zijn gehard om kanten te knippen. Knijpt koper en aluminium elektrische kabels tot 2AWG (14 mm²) diameter HRC 60-62.

Order nr.	144050101	
Orig. nr.	496	
Lengte	mm	250
Snijcapaciteit	mm	12
Maximum kabelgrootte	mm ²	14 (2AWG)
Prijs	€	20,90

TOOLS

Plaatscharen

TENGTOLS



Knipset. TTD-tray.

Bestaande uit:

- 2 plaatscharen (recht/rechts (491) - recht/links (492))
- een breekmes (701N)
- een schaar (497)
- een extra-zware kabelknijptang (496 - 590mm)

Order nr.	144020104	
Orig. nr.	TTDCT05	
Prijs	€	71,90

TENGTOLS



Kabel knipper.

Order nr.	160390100	
Orig. nr.	495	
Gerold staal	mm	250
Roestvrij staal	mm	570
Ontwerp	rechts	
Prijs	€	19,50

TENGTOLS



490W



491W



492W

Plaatschaar. Snijranden van molybdeen staal, inductie gehard tot HRC 60-62. Voor maximaal 1,5 mm koudgewalst plaatstaal. Kunststof handgrepen. Met terugspringveer en vergrendeling met éénhandsbediening.

Order nr.	186710109	186710208	186710307
Orig. nr.	490W	491W	492W
Lengte	mm	248	250
Ontwerp	Recht	Recht/Rechts	Recht/links
Snijdikte metalen platen	mm	1,5	1,5
Snijcapaciteit roest-vrij plaatstaal	mm	0,9	0,9
Snijcapaciteit koper	mm	1,8	1,8
Snijcapaciteit koudgewalst plaatstaal	mm	1,5	1,5
Prijs	€	19,90	19,50

TENGTOLS



Metaalschaar. Schaar uit geprofileerd metaal met kunststof handgrepen. De hoek tussen het mes en de hendel laat toe dat de hand boven het materiaal blijft bij het snijden. Met veer en sluitingshendel. Model voor ofwel rechts ofwel links knippen.

Order nr.	74160300	74160409
Orig. nr.	493	494
Lengte	mm	250
Ontwerp	rechts	links
Snijcapaciteit in roestvrijstaal	mm	0,9
Snijcapaciteit plaatstaal	mm	1,5
Prijs	€	25,50

TENGOOLS



Metaalschaar. Schaar uit geperst profiel met kunststof handgrepen. De hoek tussen het mes en de hendel laat toe dat de hand boven het materiaal blijft bij het snijden. Met veer en sluitingshendel. Model voor recht en recht/links - recht/rechts knippen.

Order nr.	74160052	74160102	74160201
Orig. nr.	490	491	492
Lengte	mm 250	250	250
Ontwerp	recht	recht/rechts	recht/links
Snijcapaciteit roestvrij metaal	mm 0,9	0,9	0,9
Snijcapaciteit plaatstaal	mm 1.5	1.5	1.5
Prijs	€ 19,50	19,50	19,90

TENGOOLS

EXTRA KORT



494-7

491-7

493-7

Korte blichschaar uit gesmeed chroom-molybdeen staal. Gehard tot HRC 60-62. Samengestelde werking. Dankzij de hoek tussen de messen en het handgreep blijven de handen steeds boven het materiaal. Twee componenten handgreep. Met veer en vergrendelingshendel. Heel handig in gebruik.

Order nr.	74160011	74160029	74160037
Orig. nr.	494-7	491-7	493-7
Lengte	mm 185	190	185
Type	recht/links	recht	recht/rechts
Snijcapaciteit roestvrij plaatstaal	mm 0,9	0,9	0,9
Snijcapaciteit plaatstaal	mm 1.5	1.5	1.5
Prijs	€ 23,50	23,50	23,50

Scharen

TENGOOLS



Professionele schaar. Lengte 138mm. Blad in hoogwaardig roestvrij staal. Nylon handvat met 30% glasvezel.

Order nr.	144140100
Orig. nr.	497
Lengte	mm 138
Bladlengte	mm 42
Capaciteit zachte kabel	mm 22
Prijs	€ 24,50

TENGOOLS



Schaar. Roestvrij speciaal staal. Warm gesmeed. Matte afwerking. Voor het snijden van elektronische stukken, printplaten.

Order nr.	Orig. nr.	Lengte mm	Type punten	Prijs €
177920105	SR1160	160	scherp recht	18,90
177920204	SR1180	180	scherp recht	21,90
177920303	SR2180	180	afgerond recht	21,90
177920402	SR3160	160	scherp gebogen	20,50

TENGOOLS



Zelfsluitende tang. Speciaal roestvrij staal. Warm gesmeed. Matte afwerking. 3 stappen vergrendeling. Gegroefd.

Order nr.	Orig. nr.	Lengte mm	Type	Prijs €
177930104	SLP1160	160	recht	18,90
177930203	SLP2180	180	recht	20,90
177930302	SLP3160	160	gebogen	19,50
177930401	SLP3180	180	gebogen	22,50

TENGOOLS



Pincet. Roestvrij speciaal staal. Warm gesmeed. Matte afwerking.

Order nr.	Orig. nr.	Lengte mm	Type	Prijs €
177910205	TW1160	160	Recht, gegroefd	10,90
177910304	TW1180	180	Recht, gegroefd	11,90
177910403	TW2125	125	Gebogen, gegroefd	12,50
177910502	TW2160	160	Gebogen, glad	28,90
177910601	TW2180	170	Z-vorm, naaldpunten	28,90

Vijlen

TENGOOLS



Set van 5 handvijen L 250mm middelgrof.

Bestaat uit:

- 1 ronde handvijl
- 1 halfronde handvijl
- 1 vierkante handvijl
- 1 driehoek handvijl
- 1 platte handvijl

Geleverd met een wandrek voor montage op een muur of wandpaneel.

Order nr.	128660107 ⓘ
Orig. nr.	WRFL05
Prijs	€ 34,50

TENGOOLS



Set van 12 naaldvijen met de meeste courante modellen.

Kenmerken:

- TC-tray.
- Lengte 163mm.

Order nr.	128430105 ⓘ
Orig. nr.	TTNF12
Prijs	€ 26,90

TENGOOLS

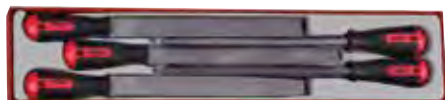

Set van 5 handvijen. TTX Tray. L. 250mm middelgrof.

Bestaande uit:

- 1 ronde
- 1 halfronde
- 1 vierkante
- 1 driehoek
- 1 platte handvijl.

Order nr.	128440104 ⓘ
Orig. nr.	TTXF05
Prijs	€ 42,90

TENGOOLS



Platte handvijl met twee vijlkanten, middel grof, lengte : 250 mm.

Order nr.	128400108 ⓘ
Orig. nr.	FLFT10
Prijs	€ 9,50

TENGOOLS



Platte handvijl met twee vijlkanten, middelgrof, lengte : 250 mm.

Order nr.	128490109 ⓘ
Orig. nr.	FLHF10
Prijs	€ 9,50

TENGOOLS



Handvijl met twee vijlkanten (rond en plat), middelgrof, lengte: 250 mm.

Order nr.	128520103 ⓘ
Orig. nr.	FLHR10
Prijs	€ 9,50

TENGOOLS



Ronde handvijl. Lengte 250 mm (middelgrof).

Order nr.	128530102 ⓘ
Orig. nr.	FLRD10
Prijs	€ 7,80

TENGOOLS



Vierkante handvijl. Lengte : 250 mm (middelgrof).

Order nr.	128540101 ⓘ
Orig. nr.	FLSQ10
Prijs	€ 8,10

TENGOOLS



Driehoekige handvijl, lengte: 250 mm (middelgrof).

Order nr.	128550100 ⓘ
Orig. nr.	FLTR10
Prijs	€ 8,40

TENGOOLS



Transfersticker Teng tools. Leverbaar in 3 verschillende afmetingen.

Order nr.	36513109	36513208	36513307
Orig. nr.	ST-R130	ST-R200	ST-R400
Formaat	13x8cm	20x12cm	40x24cm
Prijs	€ 2,90	7,40	12,50

TENGOOLS



Tengtools cap. Luxe uitvoering met prima borduring van het Tengtools ogen logo.

Order nr.	802000505
Orig. nr.	TTC
Prijs	€ 5,90

TENGOOLS



T-shirt Teng Tools.

Order nr.	800010770	800010780	800010790
Orig. nr.	TTT-REM	TTT-REL	TTT-REXL
Maat	M	L	XL
Prijs	€ 9,90	9,90	9,90

TENGOOLS



Balpen Teng Tools.

Order nr.	802000520
Orig. nr.	TTBP
Prijs	€ 1,10

TENGOOLS



Magnetische armband.

Order nr.	173200108
Orig. nr.	583M
Lengte	mm 340
Afmetingen (l x b x h)	mm 16 x 60 x 340
Prijs	€ 12,50

TENGOOLS



Sleutelhanger.

Order nr.	166680108
Orig. nr.	PKEY7
Prijs	€ 5,00

TENGOOLS



Muurvlag.

Order nr.	802000107
Orig. nr.	TTV
Afmetingen (l x b x h)	mm 2000 x 1500 x 0
Prijs	€ 35,00

TENGOOLS



Teng tools spandoek.

Order nr.	802000105
Orig. nr.	TTSP
Afmetingen (l x b x h)	mm 2000 x 800 x 0
Prijs	€ 49,90

TENGOOLS



Teng Tools sporttas, met prima borduring van het Tengtools ogen logo.

Order nr.	802000542
Orig. nr.	STT60
Afmetingen (l x b x h)	mm 50 x 30 x 30
Prijs	€ 29,90

TENGOOLS



Professionele 13-delige golfset. Met een volledige set van clubs. Sticks in glasvezel. Golfpack in een 'Typisch Teng' uitvoering. Stick-bescherming met teng-sokken. Set bevat 1 putter (90cm), 1 sandwedge (94cm), 1 pitchingwedge (94cm), 3 woods of drivers (nr 1: 117cm - nr 3: 114cm - nr 5: 112cm) en 7 irons (nr 3: 103cm - nr 4: 102cm - nr 5: 101cm - nr 6: 99cm - nr 7: 98cm - nr 8: 97cm - nr 9: 95cm).

Order nr.	36512309
Orig. nr.	TTGS
Omschrijving	Senior golfset
Prijs	€ 872,00

WORLD CHAMPION PSRX

Petter Solberg

Petter Solberg werd geboren in het Noorse dorpje Askim in 1974. Komend uit een familie van autoliefhebbers, was het duidelijk wat de missie van Petter in zijn leven zou worden. Petter begon zijn carrière in de rallycross in 1992. Drie jaar later ontdekte hij de "stage rallying". In 1998 werd hij de Noors Rally kampioen. Zijn eerste World Rally Championship titel kwam in 2003 met zijn Subaru Team. Tot op vandaag is Petter de enige piloot die Sebastien Loeb heeft verslagen over een volledig seizoen. Na een groot aantal overwinningen besloot Subaru eind 2008 te stoppen met rallysport. Solberg stelde zijn eigen team samen en ging door met rally. Sinds 2013 wordt Petter Solberg's RX Team ondersteund door Teng Tools.

Wereldkampioen

Einde 2015 werd Petter voor de derde keer wereldkampioen. Dat is twee keer op rij met zijn Teng Tools Team. In deze strijd weet Petter Solberg dat efficiëntie in de pit van groot belang is. Een tiende van een seconde kan het verschil maken tussen succes en falen. Snelle toegang tot betrouwbare instrumenten is van cruciaal belang op weg naar de overwinning. Teng Tools heeft het team hierbij geholpen.

Ondersteund door Teng Tools

Met het leveren van gereedschappen waardig aan een kampioen, heeft Teng Tools Petter Solberg begeleid naar zijn derde titel van Wereldkampioen. We weten dat je geen wereldkampioen wordt zonder hard te werken en zonder veel aandacht te besteden aan details. Kijk maar naar het technische team van Petter Solberg. Bij Teng Tools hebben we 30 jaar hard gewerkt om de beste en sterkste gereedschappen in de gereedschapskist te krijgen. Daarom zijn we trots dat het Petter Solberg Rallycross Team ons heeft gekozen als hun partner. Voor ons is dit het bewijs dat we producten van wereldklasse leveren. PSRX en Teng Tools: ' Een winnende combinatie!'

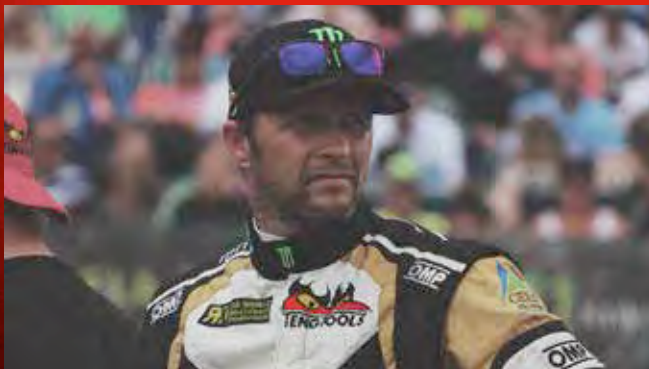



Get organised™



Automotive tools

TENGTOLS



Set van 3 speciale klemtangen voor het onbeschadigd samenklemsen van o.a. remleidingen.

Kenmerken:

- Lichte constructie.
- Toepasbaar voor de meest gangbare leidingen.
- TC-tray.

Order nr.	118420108		
Orig. nr.	TTHC03		
Aantal stuks	3		
Voor slang diameter	mm	10 · 15 · 30	
Prijs	€	27,50	

TENGTOLS



Speciaal ontworpen klemtangen met bekken die de samengeperste flexibel niet beschadigen. Lichtgewicht en gemaakt in product-neutraal materiaal. 3 maten toepasbaar voor de meest gangbare leidingen.

Order nr.	117730101	117730200	117730309
Orig. nr.	AT080	AT085	AT090
Voor slang diameter	mm	10	15
		15	30
Prijs	€	8,60	9,50
			12,90

TENGTOLS



Extra lange bektang L. 275 mm 45° gebogen. Voor diepe, moeilijk bereikbare plaatsjes. Hardheid lichaam HRC43-48. Hardheid tips HRC34.

Order nr.	144080108	144080207
Orig. nr.	AT096	AT097
Type	45° gebogen	45° gebogen
Prijs	€	17,50
		18,90

TENGTOLS



Draadvergrendeltang. Gebruikt om moeren te vergrendelen, sluitringen of dergelijke met behulp van draad. Zijknijptangen en een kleine kop voor een goede bereikbaarheid. De tang grijpt de draad en de achterste knop draait dan de draad rond. Zwart.

Order nr.	131490105	
Orig. nr.	AT605	
Prijs	€	36,90

TENGTOLS



Klepsteeldichttang met lange uiteinden om gemakkelijk klepsteeldichtingen te passen. Lengte 280mm.

Order nr.	118010107	118010206
Orig. nr.	AT025	AT030
Type	gebogen	recht
Prijs	€	28,50
		24,90

TENGTOLS



Schraper voor cilinderring groeven geleverd met vijf geharde mesjes voor verschillende cilinderring-wijdtes. Instelbaar naargelang de diameter. Gesatineerde afwerking.

Order nr.	118190107	
Orig. nr.	AT022	
Mesbreedtes	mm	2,0, 3,0, 4,0, 5,0, 5,5
Prijs	€	37,90

TENGTOLS



Montagepen voor het monteren en demonteren van ringen. Met veer-systeem en magnetisch einde voor het opnemen van verloren ringen.

Order nr.	118000108	
Orig. nr.	AT035	
Prijs	€	13,50

TENGTOLS



Multifunctionele tang met een verstelbare opening van 53 tot 118 mm. Chroom vanadium staal, geharde, vernikkelde en gesmede klauwen. Zelfsluitend met snelontkoppeling.

Order nr.	117780106	
Orig. nr.	409	
Aanpasbare hoogte	mm	53-118
Prijs	€	21,90

TENGTOLS



Filtersleutel voor het aan- en afschroeven van oliefilters tot diameter 230mm. Met chroom vanadium handvat.

Order nr.	112310305
Orig. nr.	9123
Opening	mm 160
Prijs	€ 30,50

TENGTOLS



Vervangband voor filtersleutel 9123.

Order nr.	112310404
Orig. nr.	9123RK
Prijs	€ 7,90

TENGTOLS



Filtersleutel voor het aan- en afschroeven van oliefilters tot diameter 130mm. Met nylon band en 1/2" vierkant aansluiting.

Order nr.	112310107
Orig. nr.	9110
Aansluiting	inch 1/2
Opening	mm 130
Prijs	€ 6,70

TENGTOLS



Nylon vervangband voor filtersleutel 9110.

Order nr.	112310156
Orig. nr.	9110RK
Prijs	€ 3,10

TENGTOLS



Filtersleutel voor het aan- en afschroeven van oliefilters tot diameter 120 of 150 mm. Met ketting en 1/2" vierkant aansluiting.

Order nr.	112310206
Orig. nr.	9120
Aansluiting	inch 1/2
Opening	mm 120
Prijs	€ 7,70

TENGTOLS



Vervangketting voor filtersleutel 9120.

Order nr.	112310255
Orig. nr.	9120RK
Prijs	€ 4,70

TENGTOLS



Tang voor brandstofkoppelingen. Geschikt voor brandstofkoppelingen voor de meeste wagens.

Order nr.	117890301
Orig. nr.	AT156
Prijs	€ 9,40

TENGTOLS



Hoeksleutel speciaal ontworpen voor het afstellen van schokdempers op motorfietsen.

Order nr.	132220104
Orig. nr.	HP301
Voor diameter	mm 65 - 70
Prijs	€ 7,10

TENGTOLS



5-delige extractorset met linkse spiraal. Voor extractie van gebroken schroeven en bouten. Geleverd in een plasticen doos.

Order nr.	116930108
Orig. nr.	SE05
Aantal stuks	5
Voor schroef	M6 - M20
Voor slagbit	mm 2,8, 3,5, 4,0, 6,35, 7,5
Prijs	€ 12,90

TOOLS



FIJNE SPOED

Set draaieindhalters "Out-you-Come" N°1-N°6.

Troeven:

- Hoog carbon staal
- **Nummers 1 tot 6**
- Met een bereik van M3 tot M24
- Spiraalvormig
- Fijne spoed
- Linkse draad
- Voor het verwijderen van bouten en schroeven

Tip: Iedereen heeft wel al eens verveeld gezeten met een doorgedraaide schroef of een afgebroken bout. Wat dan? Met de "Out-you-Come" draaieindhalters bieden wij hiervoor de oplossing. De schroef of bout wordt eerst precies op de geschikte diameter voor de draaieindhalter geboord. Vervolgens brengt u de uithaler in het gat en draait u tegen wijzerzin met behulp van een wringijzer, deze worden eveneens verkocht op onze website. De spiralen boren zich vervolgens een weg in de schroef of bout, door de linkse draad en de rechte draai beweging met het wringijzer, verwijdert u vervolgens de bout of schroef.

Order nr. 748529000 **M**

Orig. nr. DEU16

Prijs € **9,80**

TENGOOLS



Set van twee moersplijters. Gemakkelijk splijten van gebroken of geroeste moeren zonder het beschadigen van de bout of draad.

Order nr. 116950106 **T**

Orig. nr. NS02

Opening mm 5-20, 14-27

Voor noten M M2,5-12, 8-18

Prijs € **23,90**

TENGOOLS



Extractie-doppen met 6-kant aansluiting einde en 1/2"-aansluiting. Geschikt voor het verwijderen van blinde schroefdraad.

Order nr.	Orig. nr.	Capaciteit mm	Aansluiting inch	Prijs €
116960105 T	ST12506	6	1/2	14,50
116960204 T	ST12508	8	1/2	14,50
116960303 T	ST12510	10	1/2	15,10
116960402 T	ST12512	12	1/2	15,10

TENGOOLS



11-delige set. TC-tray.

Bestaande uit:

- 5 linkse tappen
- 4 moeren-extracteurs
- 2 moersplijters

Order nr. 69340107 **T**

Orig. nr. TTSN11

Linkse tappen inch 7/64 - 9/64 - 5/32 - 1/4 - 19/64

Extractors mm 6 - 8 - 10 - 12

Moersplijters mm 5-20, 14-27

Prijs € **60,90**

TENGOOLS



5-delige extractorset. Voor extractie van schroeven, bouten, tapeinden. Glad vierkant einde. HRC 50-52.

Order nr. 172270100 **T**

Orig. nr. TMSE05S

Voor boorgaten mm 3 - 4 - 5 - 7 - 9

Prijs € **18,90**

TENGOOLS



Aparte schroef extractors. Voor extractie van schroeven, bouten, tapeinden. Glad vierkant einde. Gehard tot HRC 50-52.

Order nr.	Orig. nr.	Voor boorgaten mm	Prijs €
151460102 T	SELO1S	3 (1/8")	3,20
151460201 T	SELO2S	4 (3/16")	3,50
151460300 T	SELO3S	5 (15/64")	5,00
151460409 T	SELO4S	7 (5/16")	5,80
151460508 T	SELO5S	9 (3/8")	6,50

TENGOOLS



Stanguittrekker voor het in- en uitdraaien van stangen. De stang wordt excentrisch geklemd door het aanspannen van het gekarteld wiel van de trekker. Aansluiting 1/2".

Order nr. 116970104 **T**

Orig. nr. 2300

Voor schroef diameter mm 5,5-19

Prijs € **24,90**

TENGOOLS



Speciale automotivе doppen. Chroom vanadium staal. Gesatineerd.

Order nr.	Orig. nr.	Aansluiting inch	Maat	Omschrijving	Prijs €
128670106	AT350	1/2"	29 mm	lambda-sonde	28,40
128670205	AT355	3/8"	22 mm	lambda-sonde	17,40
128680105	AT360	1/2"	27 mm	verstuivers van dieselmotoren	20,70
128690104	AT365	3/8"	7/8"	lambda-sonde	18,70
128700101	AT370	3/8"	1 1/16"	oliedrukregelaar	16,50
128710100	AT375	1/2"	7/8"	lambda-sonde	21,50
128720109	AT380	3/8"	7/8"	lambda-sonde	21,50

TENGOOLS



Buizenklemtang. Met een telescopische as in chroom die regelbaar is in 4 standen. Speciaal geschikt voor in moeilijk bereikbare plaatsen.

Order nr.	173030107	
Orig. nr.	BWT406	
Capaciteit	mm	32-48
Maximum lengte	mm	400
Prijs	€	21,50

TENGOOLS



Kettingsleutel - voor buizen.

Order nr.	173230103	
Orig. nr.	9124	
Capaciteit, buizen	inch	4
Prijs	€	35,90

TENGOOLS



16-delige universele olieserviceset. TC-tray.

Bestaande uit:

- 6 dubbele carterdoppen
- 2 bougiedoppen 3/8"
- 1 oliefiltersleutel
- 2 verlengstukken 3/8" L. 75 en 200mm
- 1 adaptor 1/2"-3/8"
- 1 dop 3/8" 21mm
- 1 telescopische inspectiespiegel met magneet
- een set voelermaten

Order nr.	03960101	
Orig. nr.	TTOS16	
Aantal stuks	16	
Maat carterdoppen	mm/ pouce	5/16x3/8 - 11x12 - 17x1/2 - 8x3/8 - 8x10 - 13x14
Bougiedoppen 3/8"	mm	16 - 21
Verlengstukken 3/8"	mm	75 - 250
Voelermaat, 21 bladen	mm	0,05 - 1,00
Prijs	€	58,50

TENGOOLS



Torsietaafset in TC-tray. Voor het vastzetten van wielmoeren.

Bevat:

- 4 torsiestaven variërend van 90-140 Nm
- 1 adaptor
- 3 slagdoppen voorzien van een kunststof beschermingshul voor gebruik bij o.a. alu-velgen.

Order nr.	172470403	
Orig. nr.	TTTS08	
Adaptor	inch	3/8 x 1/2
Verlengstukken	Nm	1/2" 90-110-120-140
Doppen 1/2"	mm	17-19-21
Prijs	€	76,50

TENGOOLS



Torsietaaf. Voor het vastzetten van wielmoeren met slagmoeraanzetters.

Order nr.	Orig. nr.	Voor moer Nm	Kant inch	Prijs €
172510109	923090	90	1/2	17,80
172510208	923110	110	1/2	17,80
172510307	923120	120	1/2	17,80
172510406	923140	140	1/2	17,80

TOOLS

Borstels

TOOLS



Handborstel met 1-rijige PPdraad en kunststof handgreep. Borstellengte 140mm. Totale lengte 245mm. Ook verkrijgbaar in display.

Order nr.	724581120	724581130
Orig. nr.	HA4628913008	HA462891D24
VE	1	24
Prijs/VE	€ 2,80	57,90

TOOLS



Handborstel met 4-rijige staaldraad en kunststof handgreep. Borstellengte 140mm. Totale lengte 245mm. Ook verkrijgbaar in display.

Order nr.	724581040	724581050
Orig. nr.	HA4521343008	HA452134D24
VE	1	24
Prijs/VE	€ 2,70	60,50

TOOLS



Handborstel met 4-rijige roestvrijstaal draad 0,30 mm en kunststof handgreep.

Kenmerken:

- Voor ontlasten, ontroesten, reinigen
- Borstellengte 100 mm
- Totale lengte 280 mm

Order nr.	724581075	724581070
Orig. nr.	HA4523348008	HA452334D24
VE	1	24
Prijs/VE	€ 5,00	92,90

TOOLS



Handborstel met 1-rijige roestvrijstaal draad en kunststof handgreep. Borstellengte 140mm. Totale lengte 245mm. Ook verkrijgbaar in display.

Order nr.	724581100	724581110
Orig. nr.	HA4623913008	HA462391D24
VE	1	24
Prijs/VE	€ 6,20	128,00

ILAWK



Nylon borstel op stift - op blister. Wielmodel.

Order nr.	724581230	
Orig. nr.	HA6002919009	
Diameter	mm	50
Asgat	mm	6
Toerental	tpm	4500
VE	1	
Min. bestelhoeveelheid	5	
Prijs/VE	€	4,10

ILAWK



Komborstel. Geharde staaldraad 0,50 mm - getordeerd. DIN 68 347.

Order nr.	724581310	
Orig. nr.	HA6081563008	
Diameter	mm	125
Toerental	tpm	6500
Hoogte borstel (T)	mm	24
Draad	M	14x2,00
Draadbundels	32	
VE	1	
Min. bestelhoeveelheid	5	
Prijs/VE	€	18,50

ILAWK



Rondborstels voor slijpmolens.

Troeven:

- Messing gecoate stalen draden

Geschikt voor:

- algemene werkzaamheden
- montage op slijpmolens

Geleverd met:

- flensringen 12.7mm, 15.887mm, 19.05mm, 22.225mm en 25.4mm.

Order nr.	Orig. nr.	Dia- meter	Diameter	As- gat	Voor Toerental	Prijs
		mm	mm	mm	tpm	€
724581180	HA5440623008	150 x 25	0.3	32	GU15 ME15	6000 8,60
724581185	HA5540623008	178 x 25	0.3	32	GU18	6000 0,00
724581190	HA5660623008	200 x 25	0.3	32	GU20 ME20	4500 10,50
724581195	HA5760623008	250 x 25	0.3	32	GU25	4000 13,50

ILAWK



Batterijklem-kuiser. Geleverd in blister. Lengte: 85mm.

Order nr.	724581140	
Orig. nr.	HA4931003108	
VE	1	
Min. bestelhoeveelheid	5	
Prijs/VE	€	2,80

Magneten & inspectiegereedschap

TENGOOLS

3-delige inspectieset met telescopische werktuigen. TC-tray.

Bestaande uit:

- 1 inspectiespiegel
- 1 vergrootglas
- 1 magneet

Alle 3 met een cliphouder/zakklem.

Order nr.	109460105	
Orig. nr.	TTTM03	
Diameter magneet	mm	12
Diameter vergrootglas/spiegel	mm	55
Gewicht	kg	0,22
Afmetingen (l x b x h)	mm	265 x 142 x 50
Prijs	€	37,50

TENGOOLS

8-delige inspectieset. TC-tray.

Bestaande uit:

- Telescopische pick-up werktuigen zoals 1 flexibele klauw en 1 telescopische pick up
- 1 inspectiespiegel
- 1 vergrootglas
- 1 LED lamp model 585

Geleverd met 2 batterijen.

Order nr.	144370103	
Orig. nr.	TTTM08	
Lengte flexibele pickup	mm	310
Lengte telescopische pickup	mm	160-480
Gewicht	kg	0,81
Afmetingen (l x b x h)	mm	265 x 142 x 50
Prijs	€	50,50

TENGOOLS

Telescopische controle-spiegel met een krachtige magneet en pen. Met pocket-clip. Ook verkrijgbaar in display.

Order nr.	35680107	
Orig. nr.	582MI	
Diameter magneet	mm	6
Diameter spiegel	mm	32
Lengte minimum/maximum	mm	230 - 570
Sets in display	-	
Gewicht	kg	0,04
Afmetingen (l x b x h)	mm	8 x 32 x 230
Prijs	€	16,50

TENGOOLS

Magnetische pick-up pen met schrijpen aan het andere uiteinde. Kan tot 540mm lengte worden uitgeschoven. Ideaal om metalen componenten op te pikken. Met pocket-clip. Ook verkrijgbaar in display.

Order nr.	04200101	801100166
Orig. nr.	585MP	5850MP
Diameter magneet	mm	6
Lengte minimum/maximum	mm	135 - 540
Sets in display	-	
Gewicht	kg	0,04
Afmetingen (l x b x h)	mm	13 x 13 x 135
Prijs	€	10,90
		9,20

TENGOOLS

581TMI. Telescopische spiegel met kogelkop en pocket-clip. Handvat in rode anti-slip materie.

Order nr.	112280102	
Orig. nr.	581TMI	
Lengte	mm	250 - 850
Diameter spiegel	mm	57
Gewicht	kg	0,08
Afmetingen (l x b x h)	mm	30 x 57 x 250
Prijs	€	15,50

TENGOOLS

581TMP. Telescopische pick-up magneet met pocket-clip. Handvat in rode anti-slip materie. Een prima lange magneet om magnetisch-metalen voorwerpen in moeilijk te bereiken plaatsen te bereiken.

Order nr.	112290101	
Orig. nr.	581TMP	
Diameter magneet	mm	12
Lengte ingetrokken-uitgetrokken	mm	180 - 850
Gewicht	kg	0,07
Afmetingen (l x b x h)	mm	20 x 19 x 180
Prijs	€	16,50

TENGOOLS



Telescopische magnetische pick-up met een krachtige magneet, neemt magnetische componenten op in moeilijk te bereiken plaatsen. Plastieken handvat.

Order nr.	116790106	
Orig. nr.	SD501	
Diameter magneet	mm	7
Lengte ingetrokken-uitgetrokken	mm	160 / 550
Gewicht	kg	0,03
Afmetingen (l x b x h)	mm	15 x 14 x 178
Prijs	€	6,20

TENGOOLS

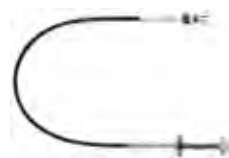

Flexibel pick up werktuig met klauw en magneet.

Order nr.	186660106	
Orig. nr.	AT135M	
Lengte	mm	600
Prijs	€	21,90

TENGOOLS



Flexibele klauw-pick up. Bestaat uit een flexibele draad met niet-magnetische tang, regelbaar vanaf het handvat. Voor het vasthouden en het opnemen van kleine voorwerpen zoals schroeven en bouten in moeilijk te bereiken plaatsen.

Order nr.	117760108	
Orig. nr.	AT135	
Lengte	mm	600
Aantal klauwgrepen		4
Gewicht	kg	0,08
Afmetingen (l x b x h)	mm	23 x 45 x 600
Prijs	€	12,50

TOOLS



Set van 4 lasmagneten waarvan 2 magneten 85x120mm en 2 magneten 100x160mm. Met 45, 90 en 135° hoek.

Order nr.	801105750	
Orig. nr.	MAGS4	
Breedte	mm	85x200 en 100x60
Magnetische draagkracht	kg	11 en 25
Gewicht	kg	1,80
Prijs	€	27,50

TENGOOLS



Magneet voor het vasthouden van plat of rond staal bij het lassen of monteren. Met 90° en 45° hoek. Niet geschikt om te gebruiken vlakbij het te verlassen gedeelte. Magnetisme kan de lasstroom beïnvloeden.

Order nr.	37300100	37300209
Orig. nr.	MH75	MH90
Breedte	mm	120
Hoogte	mm	82
Magnetische draagkracht	ca N	27
Gewicht	kg	0,30
Afmetingen (l x b x h)	mm	16 x 133 x 205
Prijs	€	8,20

TENGOOLS



Rail L. 457mm met 6 individuele magneten. Capaciteit van elke individuele magneet 450 gr. Kan bvb aan een gereedschapswagen worden bevestigd.

Order nr.	03450202	
Orig. nr.	TCMAG	
Gewicht	kg	0,60
Afmetingen (l x b x h)	mm	457 x 52 x 17
Prijs	€	32,40

TOOLS

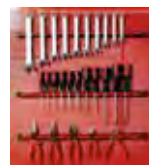

Multifunctionele magnetische rail om ijzeren en stalen gereedschappen op te hangen. Kan magnetisch bevestigd worden aan een metalen achterwand zoals een werkbank of perfopaneel.

Kenmerk:

- Capaciteit 2000 Gauss.

Order nr.	801106000	
Orig. nr.	MAG600	
Prijs	€	14,90



Magnetische rail met haak.

Perfect om uw stalen gereedschappen aan te hangen. Kan aan elke magnetische achtergrond worden bevestigd, alsook via 2 bevestigingshaken.

Kenmerk:

- Capaciteit 10kg per 3cm.

Order nr.	801105600 ⓘ	
Orig. nr.	MAG600A	
Lengte	mm	600
Gewicht	kg	1,60
Afmetingen (l x b x h)	mm	610 x 20 x 15
Prijs	€	14,90



PVC kom met een sterke magneet voor bevestiging aan gereedschapswagens, gereedschap paneel, ...

Order nr.	174610204 ⓘ	
Orig. nr.	580R	
Diameter	mm	150
Gewicht	kg	0,37
Afmetingen (l x b x h)	mm	160 x 150 x 130
Prijs	€	15,50



Roestvrijstalen schotel met 1 ronde magneet ingebouwd aan de onderkant. Deze onderkant is voorzien van een beschermende laag om schade aan bvb het wagenoppervlak te vermijden. Een prima werkinstrument om kleine zaken zoals schroeven, bouten, moeren e.d. samen te houden. Rond model diam. 150mm.

Order nr.	15610108 ⓘ	
Orig. nr.	580	
Diameter	mm	150
Gewicht	kg	0,38
Afmetingen (l x b x h)	mm	157 x 42 x 157
Prijs	€	12,90



Roestvrijstalen schotel met 2 ronde magneten ingebouwd aan de onderkant. Deze onderkant is voorzien van een beschermende laag om schade aan bvb het wagenoppervlak te vermijden. Een prima werkinstrument om kleine zaken zoals schroeven, bouten, moeren e.d. samen te houden. Kan ook omgekeerd en zijdelings worden gebruikt. Rechthoekig model 320x150mm.

Order nr.	118470103 ⓘ	
Orig. nr.	580A	
Gewicht	kg	0,87
Afmetingen (l x b x h)	mm	325 x 150 x 70
Prijs	€	27,50



Vierkante magnetische schotel 295x270mm.

Grote magnetische roestvrijstalen schotel met 4 magneten met kunststof bedekt om de lak van de wagen niet te beschadigen.

Order nr.	186870101 ⓘ	
Orig. nr.	580S	
Gewicht	kg	1,00
Afmetingen (l x b x h)	mm	295 x 270 x 42
Prijs	€	37,90



Magnetiseer en demagnetiseer gereedschap voor schroevendraaiertips.

Order nr.	60600103 ⓘ	
Orig. nr.	MR500	
Gewicht	kg	0,07
Afmetingen (l x b x h)	mm	60 x 30 x 20
Prijs	€	6,60

TOOLS

Gereedschapskoffers en wagens MW Tools



Veiligheidskoffer.

Kenmerken:

- Waterbestendig, schokbestendig en stofvrij.
- Lichaam in stevig PP.
- Mousse afdichting in het deksel.
- RVS scharnieren.
- Hoogwaardige afdichtingsring in het deksel tegen water en stof.

Voordelen:

- De opbergruimte van de koffer is opgevuld met vooruitgesneden mousse en biedt u de mogelijkheid om degewenste vorm uit te snijden.
- Koffer wordt luchtdicht afgesloten dankzij een speciale afsluitknop.
- Resistent aan temperaturen van -20 tot +80°C.
- Mogelijkheid tot afsluiten met hangslot (niet inbegrepen).

Order nr.	Orig. nr.	Maximum gewicht kg	Binnenafmetingen (l x b x h) mm	Ge-Afmetingen (l x b x h) kg	Prijs €	
758136531	SOP140		213x116x50	0,34	239 x 144 x 70	20,50
758136210	SOP210	10	186x123x75	0,65	210 x 170 x 90	27,90
758136532	SOP250		235x145x62	0,45	246 x 175 x 77	30,90
758136533	SOP300		241x188x184	1,70	300 x 248 x 212	87,90
758136330	SOP330	18	300x220x90	1,70	330 x 280 x 120	65,90
758136534	SOP420		382x269x158	2,50	420 x 327 x 186	112,00
758136430	SOP430	25	395x320x117	3,10	430 x 380 x 155	85,50
758136515	SOP500	32	485x355x170	4,30	515 x 415 x 200	148,00
758136535	SOP515		485x355x145	3,60	515 x 415 x 158	143,00



Veiligheidskoffer op wielen.

Kenmerken:

- Regenbestendig, schokbestendig en stofvrij.
- Lichaam in stevig PP.
- RVS scharnieren.
- Koffer wordt luchtdicht afgesloten dankzij een speciale afsluitknop.

Voordelen:

- De opbergruimte van de koffer is opgevuld met vooruitgesneden mousse en biedt u de mogelijkheid om de gewenste vorm uit te snijden.
- Hoogwaardige afdichtingsring in het deksel beschermt tegen water en stof.
- Resistent aan temperaturen van -20 tot +80°C.
- Mogelijkheid tot afsluiten met hangslot (niet inbegrepen).



Order nr.	Orig. nr.	Maximum gewicht kg	Binnenafmetingen (l x b x h) mm	Gewicht kg	Alfmetingen (l x b x h) mm	Prijs €
758136518	SOW410	32	430x170x345	4,30	475 x 190 x 410	160,00



Veiligheidskoffer op wielen.

Kenmerken:

- Regenbestendig, schokbestendig en stofvrij.
- Lichaam in stevig PP.
- RVS scharnieren.
- Koffer wordt luchtdicht afgesloten dankzij een speciale afsluitknop.

Voordelen:

- De opbergruimte van de koffer is opgevuld met vooruitgesneden mousse en biedt u de mogelijkheid om de gewenste vorm uit te snijden.
- Hoogwaardige afdichtingsring in het deksel beschermt tegen water en stof.
- Resistent aan temperaturen van -20 tot +80°C.
- Mogelijkheid tot afsluiten met hangslot (niet inbegrepen).



Order nr.	Orig. nr.	Maximum gewicht kg	Binnenafmetingen (l x b x h) mm	Gewicht kg	Alfmetingen (l x b x h) mm	Prijs €
758136522	SOW560	32	285x170x500	4,30	350 x 1900 x 560	160,00



Veiligheidskoffer op wielen.

Kenmerken:

- Regenbestendig, schokbestendig en stofvrij.
- Lichaam in stevig PP.
- RVS scharnieren.
- Koffer wordt luchtdicht afgesloten dankzij een speciale afsluitknop.

Voordelen:

- De opbergruimte van de koffer is opgevuld met vooruitgesneden mousse en biedt u de mogelijkheid om de gewenste vorm uit te snijden.
- Hoogwaardige afdichtingsring in het deksel beschermt tegen water en stof.
- Resistent aan temperaturen van -20 tot +80°C.
- Mogelijkheid tot afsluiten met hangslot (niet inbegrepen).



Order nr.	758136526 €		
Orig. nr.	SOW530		
Maximum gewicht	kg	40	
Binnenafmetingen (l x b x h)	mm	490x240x290	
Gewicht	kg	5,60	
Afmetingen (l x b x h)	mm	530 x 290 x 350	
Prijs	€	180,00	



Veiligheidskoffer op wielen.

Kenmerken:

- Regenbestendig, schokbestendig en stofvrij.
- Lichaam in stevig PP.
- RVS scharnieren.
- Mogelijkheid tot afsluiten met hangslot (niet inbegrepen).

Voordelen:

- De opbergruimte van de koffer is opgevuld met vooruitgesneden mousse en biedt u de mogelijkheid om de gewenste vorm uit te snijden.
- Hoogwaardige afdichtingsring in het deksel beschermt tegen water en stof.
- Koffer wordt luchtdicht afgesloten dankzij een speciale afsluitknop.
- Resistent aan temperaturen van -20 tot +80°C.

Order nr.	Orig. nr.	Binnenafmetingen (l x b x h) mm	Gewicht kg	Afmetingen (l x b x h) mm	Prijs €
758136527 €	SOW625	581x360x298	7,70	625 x 420 x 340	256,00
758136528 €	SOW975	912x370x135	8,00	975 x 430 x 168	250,00
758136529 €	SOW1133	1066x368x136	8,60	1133 x 422 x 155	276,00
758136530 €	SOW1346	1270x335x138	10,30	1346 x 394 x 165	312,00



5-delige stalen gereedschapskoffer L. 530mm.

Kenmerken:

- Dikte staalplaat 0.6mm.
- Afsluitbaar.
- Met hangslot (niet inbegrepen).

Order nr.	728600530 †		
Orig. nr.	TC530		
Gewicht	kg	5,10	
Afmetingen (l x b x h)	mm	530 x 200 x 200	
Prijs	€	31,50	



7-delige stalen gereedschapskoffer L. 530mm.

Kenmerken:

- Staalplaat 0.6mm.
- Met hangslot (niet inbegrepen).

Order nr.	112440203 †		
Orig. nr.	TC427		
Gewicht	kg	5,00	
Afmetingen (l x b x h)	mm	530 x 200 x 250	
Prijs	€	41,50	

TOOLS



Metalen materiaalcoffer met foam inleg. Hoogte 68mm.

Order nr.	856001580 €
Orig. nr.	MKF68
Afmetingen (l x b x h)	mm 443 x 355 x 68
Prijs	€ 34,50



Metalen opbergcoffer met 46 bakjes. Hoogte 100 mm.

Order nr.	856001583 €
Orig. nr.	MK100
Afmetingen (l x b x h)	mm 443 x 355 x 100
Prijs	€ 49,50



Metalen materiaalcoffer met 23 bakjes. Hoogte 68mm.

Order nr.	856001582 €	856001586 €
Orig. nr.	MK68	MK68-5
VE	1	5
Afmetingen (l x b x h)	mm 443 x 355 x 68	
Prijs/VE	€ 34,50	157,00



Metalen materiaalcoffer met 46 bakjes. Hoogte 135 mm.

Order nr.	856001585 €
Orig. nr.	MK135
Afmetingen (l x b x h)	mm 443 x 355 x 135
Prijs	€ 55,50

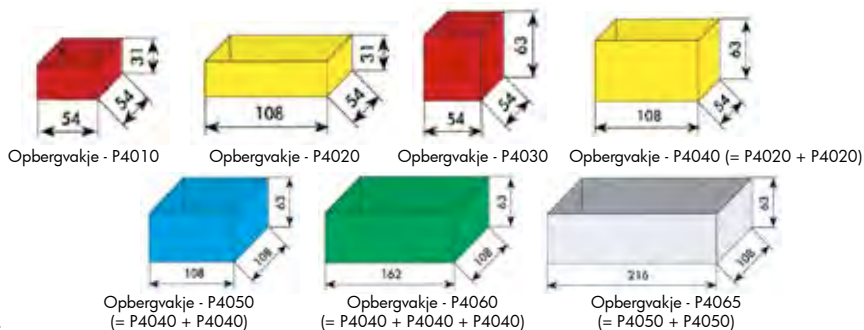

Kunststof opbergvakjes.

VE = verpakkingseenheid.

Order nr.	Orig. nr.	Omschrijving	Gewicht	VE	Afmetingen (l x b x h)	Prijs/VE
			kg		mm	€
815614011 €	P4010S	bakje 4010 enkel laag rood	1,00	60	54 x 31 x 54	27,90
815614021 €	P4020S	bakje 4020 dubbel laag geel	0,01	60	108 x 31 x 54	36,50
815614031 €	P4030S	bakje 4030 enkel hoog rood	0,02	60	54 x 63 x 54	41,50
815614041 €	P4040S	bakje 4040 dubbel hoog geel	0,03	60	108 x 63 x 54	65,50
815614051 €	P4050S	bakje 4050 dubbel hoog blauw	0,06	60	108 x 63 x 108	76,90
815614061 €	P4060S	bakje 4060 dubbel hoog groen	0,08	40	162 x 63 x 108	73,50
815614066 €	P4065S	bakje 4065 dubbel hoog grijs	0,10	30	216 x 63 x 108	88,90

TOOLS



Mobiele werktafel. Stevige gelaste stalen constructie.

Kenmerken:

- Zijdelingse duwbaar en met slot.
- 2 vaste wielen, 2 draaibare met rem.
- Hamerslag gelakt in grijs en rood.
- Capaciteit leggers 50kg.
- Ingelegd bovenblad in multiplex 40mm.

Order nr.	856001155 ⓘ		
Orig. nr.	DEW12060K2		
Aantal laden	0		
Aantal liggers	4		
Dikte multiplex plaat	mm	40	
Capaciteit legplanken	kg	50	
Capaciteit werkbank	kg	240	
Gewicht	kg	50,00	
Afmetingen (l x b x h)	mm	1200 x 600 x 950	
Prijs	€	367,00	

TOOLS



lade met ladeindeling en kast met 2 legborden

Mobiele werktafel. Stevige gelaste stalen constructie.

Kenmerken:

- Zijdelingse duwbaar en met slot.
- 2 vaste wielen, 2 draaibare met rem.
- Hamerslag gelakt in grijs en rood.
- Capaciteit leggers 50kg.
- Ingelegd bovenblad in multiplex 40mm

Geschikt voor:

- Met 3 lades, geschikt voor de Teng Tools TC Trays

Order nr.	856001140 ⓘ		
Orig. nr.	DEW12060L		
Aantal laden	3		
Afmetingen kleine lade	mm	38,3x57,4x9	
Afmetingen grote lade	mm	38,3x57,4x16,5	
Aantal liggers	2		
Dikte multiplex plaat	mm	40	
Capaciteit legplanken	kg	50	
Capaciteit werkbank	kg	240	
Capaciteit lades	kg	50	
Gewicht	kg	80,00	
Afmetingen (l x b x h)	mm	1200 x 600 x 950	
Prijs	€	429,00	

TOOLS



lade met ladeindeling

Mobiele werktafel. Stevige gelaste stalen constructie.

Kenmerken:

- Zijdelingse duwbaar en met slot.
- 2 vaste wielen, 2 draaibare met rem.
- Hamerslag gelakt in grijs en rood.
- Ingelegd bovenblad in multiplex 40mm.

Geschikt voor:

- Met 6 lades, geschikt voor de Teng Tools TC Trays.

Order nr.	856001145 ⓘ		
Orig. nr.	DEW12060L2		
Aantal laden	6		
Aantal liggers	0		
Dikte multiplex plaat	mm	40	
Capaciteit werkbank	kg	240	
Capaciteit lades	kg	50	
Gewicht	kg	92,00	
Afmetingen (l x b x h)	mm	1200 x 600 x 950	
Prijs	€	499,00	

TOOLS



Mobiele werktafel met 5 lades en 1 kast met ligger.

Kenmerken:

- Met 2 sloten, lades centrale sluiting
- Sterke gelaste stalen constructie
- 5 lades: 1 lade 998x71x525, 3 lades 452x81x536, 1 lade 452x81x536
- 2 vaste wielen Ø 125 mm, 2 draaibaar met rem
- Capaciteit lades 40 kg, 100% telescopische extensie, en gum stop
- Bovenblad in multiplex 25 mm, beuken fineer afwerking
- Met handvat

Order nr.	856001148 ⓘ		
Orig. nr.	DEW12060L5		
Aantal laden	5		
Maximum gewicht per lade	kg	40	
Aantal liggers	1		
Dikte multiplex plaat	mm	25	
Gewicht	kg	90,00	
Afmetingen (l x b x h)	mm	1200 x 605 x 920	
Prijs	€	539,00	

TOOLS



Robuuste gereedschapswagen met 7 rolgelagerde lades (5x75mm en 2x160mm)

Kenmerken:

- Afsluitbaar met sleutelslot
- 2 geperforeerde zijwanden (geschikt voor Modular haken)
- 2 zwenkwielen met rem en twee vaste wielen
- Rubber bovenmat
- Handvat
- Kleur: frame rood 3000, lades grijs 7001

Order nr.	856001106
Orig. nr.	GW107G
Aantal lades	7
Afmetingen middelgrote lade	mm 580x410x75 (x5)
Afmetingen grote lade	mm 580x410x160 (x2)
Gewicht	kg 60,00
Afmetingen (l x b x h)	mm 840 x 480 x 965
Prijs	€ 309,00



Robuuste gereedschapswagen. 7 rolgelagerde lades (5x75mm en 2x160mm)

Kenmerken:

- Afsluitbaar met sleutelslot
- 2 geperforeerde zijwanden (geschikt voor Modular haken)
- 2 zwenkwielen met rem en twee vaste wielen
- Rubber bovenmat
- Handvat
- Kleur: rood 3000

Order nr.	856001105
Orig. nr.	GW107R
Aantal lades	7
Afmetingen middelgrote lade	mm 580x410x75 (x5)
Afmetingen grote lade	mm 580x410x160 (x2)
Gewicht	kg 60,00
Afmetingen (l x b x h)	mm 840 x 480 x 965
Prijs	€ 309,00



NEW
LARGE

Robuuste gereedschapswagen met 7 rolgelagerde lades (5x75mm en 2x160mm)

Kenmerken:

- Afsluitbaar met sleutelslot
- 2 geperforeerde zijwanden (geschikt voor Modular haken)
- 2 zwenkwielen met rem en twee vaste wielen
- Rubber bovenmat
- Handvat
- Kleur: frame rood 3000, lades grijs 7001

Order nr.	856001103
Orig. nr.	GW207
Aantal lades	7
Afmetingen middelgrote lade	mm 770x410x75 (x5)
Afmetingen grote lade	mm 770x410x160 (x2)
Gewicht	kg 70,00
Afmetingen (l x b x h)	mm 940 x 480 x 950
Prijs	€ 409,00



Gereedschapswagen met zeer robuust frame. Met 15 afsluitbare rolgelagerde lades.

Kenmerken:

- 2 geperforeerde zijwanden (hierop passen Modular haken).
- 2 geremde wielen.
- Rubber bovenmat en handgreep.
- De lades zijn op maat gemaakt voor uw tool-trays.

Order nr.	856001117
Orig. nr.	GW115
Aantal lades	15
Afmetingen kleine lade	mm 580x410x72 (x2)
Afmetingen middelgrote lade	mm 580x410x150 (x2)
Afmetingen grote lade	mm 1240x410x72 (x1)
Maximum gewicht per lade	kg 50
Gewicht	kg 100,00
Afmetingen (l x b x h)	mm 1408 x 470 x 1050
Prijs	€ 695,00

TOOLS



Robuuste gereedschapskoffer met 4 rolgelagerde lades (4x75mm)

Kenmerken:

- Afsluitbaar met sleutelslot
- 2 geperforeerde zijwanden (geschikt voor Modular haken)
- Rubber bovenmat
- Kleur frame: rood 3000, Kleur lades: grijs 7001

Order nr.	856001104
Orig. nr.	GT104G
Aantal laden	4
Afmetingen middelgrote lade	mm 580x410x75 (x4)
Gewicht	kg 32,00
Prijs	€ 204,00

TOOLS



Werkplaatswagen met 3 plateaus.

Kenmerken:

- Met 2 vaste en 2 zwenkwielen met rem.

Order nr.	751503000
Orig. nr.	DERG003
Aantal lade	0
Maximum gewicht per lade	kg 45
Aantal liggers	3
Gewicht	kg 15,00
Afmetingen (l x b x h)	mm 900 x 450 x 900
Prijs	€ 98,50

Accessoires

TOOLS



Werkblad multiplex TT. Geschikt voor plaatsing op uw teng tools materiaal kar. Schokbestendige en stevige bescherming van uw bovenblad.

Order nr.	856001356	856001357
Orig. nr.	TTMP660	TTMP1340
Gewicht	kg 12,00	24,00
Afmetingen (l x b x h)	mm 660 x 453 x 30	1340 x 453 x 30
Prijs	€ 47,90	91,90

TOOLS



Geribde rubbermat op rol. Dikte 3mm. Gebruikt ter bescherming van vb. lades. Diverse toepassingsmogelijkheden. Op rol van 10m. Breedte 1,2m.

Order nr.	751988120
Orig. nr.	FRSRM1200
Gewicht	kg 1,00
Prijs	€ 107,00

TOOLS



Multifunctionele magnetische rail om ijzere en stalen gereedschappen op te hangen. Kan magnetisch bevestigd worden aan een metalen achterwand zoals een werkbank of perforatiepaneel.

Kenmerk:

- Capaciteit 2000 Gauss.

Order nr.	801106000
Orig. nr.	MAG600
Prijs	€ 14,90

TOOLS



Magnetische rail met haak.

Perfect om uw stalen gereedschappen aan te hangen. Kan aan elke magnetische achtergrond worden bevestigd, alsook via 2 bevestigingshaken.

Kenmerk:

- Capaciteit 10kg per 3cm.

Order nr.	801105600
Orig. nr.	MAG600A
Lengte	mm 600
Gewicht	kg 1,60
Afmetingen (l x b x h)	mm 610 x 20 x 15
Prijs	€ 14,90

TOOLS



Documenthouder voor GW-serie gereedschapskar

Order nr.	856001165
Orig. nr.	GWAWC
Voor type	GW
Gewicht	kg 1,00
Afmetingen (l x b x h)	mm 290 x 330 x 160
Prijs	€ 32,50

TOOLS



Papierrolhouder voor GW-serie gereedschapskar

Order nr.	856001166
Orig. nr.	GWAPH
Voor type	GW
Gewicht	kg 1,00
Afmetingen (l x b x h)	mm 333 x 150 x 250
Prijs	€ 32,50

TOOLS



Bakje voor GW-serie gereedschapskar

Order nr.	856001167
Orig. nr.	GWASB
Voor type	GW
Gewicht	kg 1,00
Afmetingen (l x b x h)	mm 290 x 330 x 160
Prijs	€ 8,50

Gereedschapssets MW Tools

91-DELIG



INDUSTRIAL QUALITY
CHROME VANADIUM STEEL

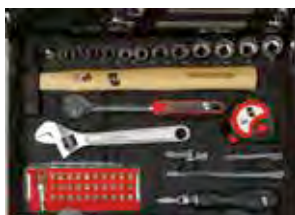

TOOLS

91-delige gereedschapskoffer voor de vakman met full chrome vanadium gereedschap.

Bestaande uit:

- 3 tangen
- 1 cutter
- basis-HSS borenset
- 1 mini-beugelzaag
- 4 plat/Pz schroevendraaiers
- 1 set ballpoint-allensleutels
- 7 steekringsleutels 8-17mm
- 1 ratel
- 11 doppen 3/8" van 9 tot 20mm
- 1 schroefleutel 200mm
- 1 bitshouder
- bits-ratelhandvat
- 31 bitsen 1/4"
- 1 bankhamer 300g
- 1 rolmeter 3.5m.

Verpakt in een stevige alu-koffer.

Order nr.		855006908
Orig. nr.		BTK91A
Aantal stuks		91
Allensleutels	mm	2,5 - 3 - 4 - 5 - 6 - 8 - 10
Bankhamer	g	300
Rolmeter		3,5m x 12mm
Kniekoppeling	mm	3/8" + adapt. 3/8"(F) - 1/4"(M)
Schroefleutels	mm	200 (8")
Tangen		langebektang 160mm, knijptang 160mm, platte bektang 180mm
Schroevendraaiers		Plat 6,5x100mm - Plat 5x75mm - PH1x75mm - PH2x100mm
Bitsen 1/4"		PH0 - PH1 - PH2 - PH3 - PH4 - PZ0 - PZ1 - PZ2 - PZ3 - PZ4 - T10 - T15 - T20 - T25 - T27 - T30 - Plat 3mm - Plat 4mm - Plat 4,5mm - Plat 5mm - Plat 5,5mm - Plat 6mm - Plat 7mm - H1,5 - H2 - H2,5 - H3 - H4 - H5 - H6
Bitshouder 1/4"	mm	60
Mini beugelzaag	mm	150
Doppen 3/8"	mm	9 - 10 - 11 - 12 - 13 - 14 - 16 - 17 - 18 - 19 - 20
Ratel 3/8" aantal tanden		45
Verlengstukken 3/8"	mm	75 - 150
Steekringsleutels		8 - 10 - 11 - 12 - 13 - 14 - 17
Borenset		HSS-Ti (2mm - 3mm - 4mm - 5mm - 6mm - 8mm) - beton (4mm - 5mm - 6mm - 8mm - 10mm) - hout (4mm - 5mm - 6mm - 8mm - 10mm)
Alu koffer	mm	365x265x120
Gewicht	kg	6,70
Prijs	€	139,00



TOOLS

99-delige toolset in 5 delige metalen koffer.

Deze set bevat doppen 1/2" 13-24mm + accessoires, magnetische bitshouder, 43-delige bitsset, steekringsleutels 6-22mm, 8 schroevendraaiers plat en PH, combinatietang, zijknijptang, waterpompang, griptang, beitset, hamer, handzaag, rolmeter en handlamp.

Bestaande uit:

- Doppen 1/2": 10 - 13 - 14 - 16 - 17 - 18 - 19 - 20 - 22 - 24 mm;
- Bougiedoppen 1/2": 16 - 21mm;
- Ratel 1/2": 72 tanden;
- Verlengstuk: 125 - 250 mm;
- Universele koppeling 1/2";
- Adaptor: 1/2" (F) - 3/8" (M);
- Steekringsleutels: 6 - 7 - 8 - 9 - 10 - 11 - 12 - 13 - 14 - 15 - 16 - 17 - 18 - 19 - 20 - 22 mm;
- Bitsset met handvat: plat 3(x2) - 4(x2) - 5(x2) - 6(x2) - 7(x2) mm, PH 0(x2) - 1(x2) - 2(x2) - 3(x2), PZ 0(x2) - 1(x2) - 2(x2) - 3(x2), TX 10 - 15 - 20 - 25 - 27 - 30, HEX 2 - 2.5 - 3 - 4 - 5 - 5.5 - 6, vierkant 0 - 1 - 2 - 3;
- Magnetische bitshouder: 1/4";
- Combinatietang: 7";
- Zijknijptang: 6";
- Griptang: 7";
- Waterpompang: 10";
- Schroevendraaiers: PH2x38 - PH0x75 - PH1x75 - PH2x100 - PL6.5x38 - PL3.0x75 - PL5.5x75 - PL6.5x100 mm;
- Beitset: pen 3mm, doorslag 8mm, drevel 6mm, ritsbeitel 5mm, koudbeitel 13mm;
- Hamer: 300g;
- Rolmeter: 3m;
- Handzaag: 10";
- Handlamp

Order nr.		855006919
Orig. nr.		BTK99A
Aantal stuks		99
Gewicht	kg	13,60
Afmetingen (l x b x h)	mm	460 x 260 x 200
Prijs	€	149,00



134-delige gereedschapskoffer voor de vakman met full chrome vanadium gereedschap.

Bestaande uit:

- 3 tangen 160/180mm
- 1 schaarantag
- 1 waterpomptang
- 1 schrijnwerkerstang
- 1 vijl L. 250mm
- 1 cutter
- 1 mini-beugelzaag
- 4 plat/Pz schroevendraaiers
- 1 mini-schroevendraaier/testlamp
- 1 set ballpoint-allensleutels
- 9 steekringsleutels 8-22mm
- 1 ratel en 13 doppen 1/4" van 4 tot 14mm
- 1 ratel en 13 doppen 1/2" van 10 tot 32mm met accessoires
- 1 schroefleutel 250mm
- 1 beitel- en doorslagset
- 1 bitshouder en 20 bitsen plat, Ph, Pz, Tx, hex
- 1 mini-bitshouder en 10 mini-bitsen
- 1 bankhamer 300g
- 1 rolmeter 5m
- combi-circlipstang
- Led-werklamp
- kabelschoenen en -tang
- waterpas L. 300mm
- schuifmaat L. 150mm

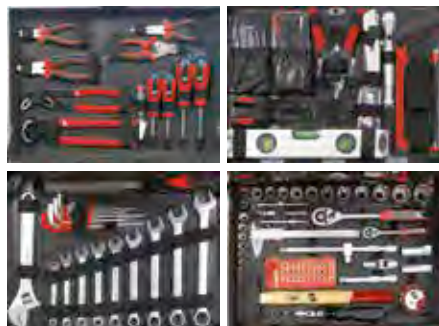

Verpakt in een stevige alu-koffer.

Order nr.	855006913	
Orig. nr.	BTK134A	
Aantal stuks	134	
Doppen 1/4"	mm	4 - 4,5 - 5 - 5,5 - 6 - 7 - 8 - 9 - 10 - 11 - 12 - 13 - 14
Doppen 1/2"	mm	10 - 13 - 14 - 16 - 17 - 18 - 19 - 20 - 22 - 24 - 27 - 30 - 32
T-baar 1/4"	1	
Verlengstukken 1/4"	mm	50 - 100
Verlengstukken 1/2"	mm	125 - 250
Allensleutels	mm	1,5 - 10
Steekringsleutels	mm	8 - 10 - 11 - 12 - 13 - 14 - 17 - 19 - 22
Rolmeter	5m x 3/4"	
Doppen 1/2" lang	mm	16 - 21
Ratel 1/4" aantal tanden	48	
Ratel 1/2"	48	
T-baar 1/2"	1	
Kniekoppeling	mm	1/4" - 1/2"
Schroefleutels	mm	250 (10")
Tangen	langebektang 160mm, kniptang 160mm, platte bektang 180mm, HD kniptang 180mm - waterpomptang 240mm	
Circlipstang	combitang met 4 klauwen	
Schrijnwerkerskniptang	mm	250 C-V (10")
Schroevendraaiers	Plat 6,5x100mm - Plat 5x75mm - PH1x75mm - PH2x100mm	
Bitsen 1/4"	PH1 - PH2 - PH3 - PH4 - PZ1 - PZ2 - PZ3 - PZ4 - T10 - T15 - T20 - T25 - T30 - T40 - Plat 5,5mm - Plat 6mm - Plat 8mm - H4 - H5 - H6	
Set d'embouts - type mini	Plat 1mm - Plat 1,5mm - Plat 2mm - Plat 2,5mm - Plat 3mm - Plat 3,5mm - Plat 4mm - PH0 - PH00 - PH000	
Bitshouder 1/4"	mm	60
Autotester	V	100 - 250
Aantal kabelschoenen	40	
Vijlen	halfmond	
Waterpas	mm	300
Werklamp	aluminium model met lamp	
Meetlat	mm	150
Beitelse	5 dlg. 4mm pen, 1 centerpunt, 1 doorslag 3mm, 1 beitel 5 en 12mm	
Bankhamer	mm	300
Mini beugelzaag	mm	150
Type koffer	koffer alu	
Gewicht	kg	13,00
Prijs	€	219,00



**INDUSTRIAL QUALITY
CHROME VANADIUM STEEL**

NEW 134-DELIG 16KG

134-delige gereedschapskoffer voor de vakman met full chrome vanadium gereedschap. In stevige Heavy Duty koffer.

HEAVY DUTY KOFFER

Bestaande uit:

- 3 tangen 160/180mm
- 1 schaarantag
- 1 waterpomptang
- 1 schrijnwerkerstang
- 1 vijl L. 250mm
- 1 cutter
- 1 mini-beugelzaag
- 4 plat/Pz schroevendraaiers
- 1 mini-schroevendraaier/testlamp
- 1 set ballpoint-allensleutels
- **9 ratelsteekringsleutels 8-22mm**
- 1 ratel en 13 doppen 1/4" van 4 tot 14mm
- 1 ratel en 13 doppen 1/2" van 10 tot 32mm met accessoires
- 1 schroefleutel 250mm
- 1 beitel- en doorslagenset
- 1 bitshouder en 20 bitsen plat, Ph, Pz, Tx, hex
- 1 mini-bitshouder en 10 mini-bitsen
- 1 bankhamer 300g
- 1 rolmeter 5m
- combi-circlipstang
- Led-werklamp
- kabelschoenen en -tang
- waterpas L. 300mm
- schuifmaat L. 150mm



TOOLS

Verpakt in een stevige koffer voor de professioneel.

Order nr.	855006925	
Orig. nr.	BTK141HD	
Aantal stuks	134	
Doppen 1/4"	mm	4 - 4,5 - 5 - 5,5 - 6 - 7 - 8 - 9 - 10 - 11 - 12 - 13 - 14
Doppen 1/2"	mm	10 - 13 - 14 - 16 - 17 - 18 - 19 - 20 - 22 - 24 - 27 - 30 - 32
T-baar 1/4"		1
Verlengstukken 1/4"	mm	50 - 100
Verlengstukken 1/2"	mm	125 - 250
Allensleutels	mm	1,5 - 10
Steekringsleutels	mm	8 - 10 - 11 - 12 - 13 - 14 - 17 - 19 - 22
Rolmeter		5m x 3/4"
Doppen 1/2" lang	mm	16 - 21
Ratel 1/4" aantal tanden		48
Ratel 1/2"		48
T-baar 1/2"		1
Kniekoppeling	mm	1/4" - 1/2"
Schroefleutels	mm	250 (10")
Tangen		langebektang 160mm, kniptang 160mm, platte bektang 180mm, HD kniptang 180mm - waterpomptang 240mm
Circlipstang		combitang met 4 klauwen
Schrijnwerkerskniptang	mm	250 Cr-V (10")
Schroevendraaiers		Plat 6,5x100mm - Plat 5x75mm - PH1x75mm - PH2x100mm
Bitsen 1/4"		PH1 - PH2 - PH3 - PH4 - PZ1 - PZ2 - PZ3 - PZ4 - T10 - T15 - T20 - T25 - T30 - T40 - Plat 5,5mm - Plat 6mm - Plat 8mm - H4 - H5 - H6
Set d'embouts - type mini		Plat 1mm - Plat 1,5mm - Plat 2mm - Plat 2,5mm - Plat 3mm - Plat 3,5mm - Plat 4mm - PH0 - PH00 - PH000
Bitshouder 1/4"	mm	60
Autotester	V	100 - 250
Aantal kabelschoenen		40
Vijlen		half rond
Waterpas	mm	300
Werklamp		aluminium model met lamp
Meetlat	mm	150
Beitelset		5 dlg. 4mm pen, 1 centerpunt, 1 doorslag 3mm, 1 beitel 5 en 12mm
Bankhamer	mm	300
Mini beugelzaag	mm	150
Type koffer		koffer alu
Gewicht	kg	16,00
Prijs	€	299,00

TOOLS

**INDUSTRIAL QUALITY
CHROME VANADIUM STEEL**



68-DELIG

68-delige gereedschapskoffer - type VDE 1000V - Chrome vanadium - voor de kwaliteitsbewuste elektricien.

Bestaande uit:

- 1 ratel en 13 doppen 1/4" van 4 tot 14mm
- 1 ratel en 9 doppen 1/2" van 10 tot 22mm en accessoires
- 1 set allensleutels 1.5-8mm
- 9 steekringsleutels 8 - 17mm
- 5 tangen VDE 1000V
- langebektang
- kniptang
- platte bektang
- waterpomptang
- ontmanteltang
- 6 precisieschroevendraaiers
- 6 schroevendraaiers VDE 1000V Ph en Plat
- 1 bankhamer 300gr
- 1 rolmeter 5m.

Opgeborgen in een stevige ABS koffer.

Order nr.	855006917
Orig. nr.	BTk68VA
Aantal stuks	68
Doppen 1/4"	4 - 4.5 - 5 - 5.5 - 6 - 7 - 8 - 9 - 10 - 11 - 12 - 13 - 14
Doppen 1/2"	10 - 13 - 14 - 16 - 17 - 18 - 19 - 20 - 22
T-baar 1/4"	1
T-baar 1/2"	50 - 100
Verlengstukken 1/4"	100
Verlengstukken 1/2"	125 - 250
Kniekoppeling	1/4" - 1/2"
Allensleutels	1,5 - 2 - 2,5 - 3 - 4 - 5 - 6 - 8
Steekringsleutels	8 - 9 - 10 - 11 - 12 - 13 - 14 - 16 - 17 langebektang 160mm - kniptang 160mm - platte bektang 160mm - waterpomptang 225mm - ontmanteltang 160mm
VDE-tangen 1000V	PH0x50mm - PH0x50mm - PH1x50mm - Plat 1,5x50mm - Plat 2x50mm - Plat 3x50mm
Precisieschroevendraaiers	Plat 2,5x75mm - Plat 4x100mm - Plat 5,5x125mm - PH0x60mm - PH1x80mm - PH2x100mm
VDE-schroevendraaiers 1000V	
Bankhamer	300 g
Rolmeter	5m x 3/4"
Type koffer	valise ABS
Gewicht	9,00 kg
Prijs	€ 199,00

TOOLS

**INDUSTRIAL QUALITY
CHROME VANADIUM STEEL**



NEW 176-DELIG



176-dlg dop- en dopbitsset 1/4" - 3/8" - 1/2". Chroom vanadium staal.

Bestaande uit:

- Doppen zeskant 1/2": 10-11-12-13-14-15-16-17-18-19-20-21-22-24-27-30-32mm; 3/8": 10-11-12-13-14-15-16-17-18-19mm, 1/4": 4-4.5-5-5.5-6-7-8-9-10-11-12-13-14mm
- Doppen diep 1/2": 16-18mm; 3/8": 10-11-12-13-14-15mm, 1/4": 4-5-6-7-8-9-10mm
- E-TX doppen 1/2": E20-24; 3/8": E10-11-12-14-16-18; 1/4": E4-5-6-7-8
- Ratels 1/2"-3/8"-1/4" 72 tanden
- Elleboogstuk 1/2"-3/8"-1/4"
- Verlengstukken 1/2": 125-250mm, 3/8": 125mm, 1/4": 50-100mm
- T-Hendel 1/2": 250mm, 1/4"
- Bougiedoppen 60mm(L) 1/2": 16-21mm, 3/8": 18mm
- Mini handratel 1/4"
- steekringsleutels: 8-9-10-11-12-13-14-15-16-17-18-19mm
- Adaptor met zeskant aansluiting 8mm 1/2" en 3/8"
- Torx sleutels: TX10-15-20-25-27-30-40-45-50
- Hex sleutels: 1.5-2.2-2.5-3-4-5-6-8-10mm
- Slagdoppen wiel 1/2" 17-19-21mm
- dopbitsen 1/4": PH0-1-2; PZ0-1-2; Plat4-5-5-6-5-7, Hex3-4-5-6
- TX8-9-10-15-20-25-27-30, TPX8-9-10-15-20-25-27-30; M8-10-12
- Bitsen 8mm(hex)x30mm(L): Hex7-8-10-12-14, PH3-4, PZ3-4, Plat8-10-12, TX40-45-50-55-60-70, TPX40-45-50-55-60-70

Order nr.	855006969
Orig. nr.	BT176
Gewicht	11,60 kg
Afmetingen (l x b x h)	540 x 215 x 375 mm
Prijs	€ 169,00

TOOLS

B.TOOL

**INDUSTRIAL QUALITY
CHROME VANADIUM STEEL**

NEW 216-DELIG



216-dlg dop- en dopbitsset 1/4" - 3/8" - 1/2". Chroom vanadium staal.

Bestaande uit:

- Doppen 1/2": 13-14-15-16-17-18-19-20-21-22-24-27-30-32mm, 3/8": 10-11-12-13-14-15-16-17-18-19mm, 1/4": 4-4.5-5-5.5-6-7-8-9-10-11-12-13-14mm
- Doppen diep 1/2": 16-17-18-19-22mm, 3/8": 10-11-12-13-14-15mm, 1/4": 4-5-6-7-8-9-10mm
- E-TX doppen 1/2": E20 - E22 - E24; 3/8": E10-E11-E12-E14-E16-E18, 1/4" E4-E5-E6-E7-E8
- Bougiedoppen 1/2" 16 - 21mm, 3/8" 18mm
- Elleboogstuk 1/2" - 3/8" - 1/4"
- Verlengstukken 1/2" 125-250mm - 3/8" 125mm - 1/4" 50-100mm
- Adaptor 1/2" M x 3/8" F
- Adaptor met zeskant aansluiting 8mm 1/2" en 3/8"
- Ratel 1/2" - 3/8" - 1/4" 24 tanden
- mini handratel 1/4"
- T-hendel 1/4"
- Magnetische bithouder en adapter 1/4"
- Dopbitsen 1/4" Hex : 3-4-5-6mm, Plat: 4-5-5-6-5-7mm, PH: 0-1-2, PZ: 0-1-2, TX: T8-T9-T10-T15-T20-T25-T27-T30, TPX:T8-T9-T10-T15-T20-T25-T27-T30
- Dopbitsen 1/2" TX70, Hex 14mm
- Bitsen 8mm(Hex) X 30mm(L):Hex: 7-8-10-12mm, Plat: 8-10-12mm, Spline: M10-12, PH: 2-3-4, PZ: 2-3-4, TX: T40-T45-T50-T55-T60, TPX: T40-T45-T50-T55-T60, Ribe: 10-11-12-13
- Bitsen 1/4" X 25mm(L): Hex : 2.2.5-3-4-5-6mm, Ribe: 5-6-7-8-9, TX T5-6-7-T7(Temper)-T10-15-20-25-27-30-40-45, Spline: 5-6-8mm, Tri-wing bits: 1-2-3-4, torq-set: 4-6-8-10, Clutch: 1-2-3, vierkant 0-1-2-3, Spanner: 6-8-10
- Hex sleutels: 1.27-1.5-2.2-5-3-4-5mm
- Steekringsleutels: 8-9-10-11-12-13-14-15-16-17-18-19mm

Order nr.	855006968 ⓘ	
Orig. nr.	BT216	
Gewicht	kg	11,25
Afmetingen (l x b x h)	mm	510 x 235 x 385
Prijs	€	119,00

TOOLS

TOOLS



108-DELIG

108-delige dop- en dopbitsset 1/4"-1/2". Verpakt in een kunststof koffer.

Bestaande uit:

- 21 korte en lange doppen 1/4" 4-14mm
- 24 korte en lange doppen 1/2" 10-32mm
- 18 dopbitsen 1/4" Hex, Plat, PH, PZ, TX
- 16 bitsen 5/16" Hex, PH, PZ, Plat, TX
- TX doppen 1/4" en 1/2"
- ratel 1/2" en 1/4" 48-tands
- accessoires 1/4" en 1/2"

Order nr.	855006916 ⓘ	
Orig. nr.	BT42108	
Gewicht	kg	6,80
Afmetingen (l x b x h)	mm	410 x 310 x 395
Prijs	€	69,90



397-DELIG



TOOLS

Order nr.	855006610	Order nr.	855006611
Orig. nr.	MWT397G	Orig. nr.	MWT397R
Aantal stuks	397	Aantal stuks	397
Gewicht	kg 76,00	Gewicht	kg 70,00
Prijs	€ 649,00	Prijs	€ 649,00

Gereedschapswagen met 7 laden en toolset 396 gereedschappen in PS-trays

Lade 1:

- Set doppen 1/4" : 4-14mm kort, 6-13mm lang, dopbitsen plat, PH, PZ, TPX, HEX 43 st.
- Set doppen 1/2" : 10-32mm 26 st.
- Bitsset met handvat 65 st.
- Precisie-schroevendraaierset 6 st.

Lade 2:

- Steeksleutels 6-32mm 11 st.
- Set Allen-sleutels Hex en Torx 17 st.
- Steekringsleutels 6-24mm 16st.

Lade 3:

- 8 geïsoleerde schroevendraaiers plat en PH
- Schroevendraaiers PH 0x75, 1x100, 2x125, 3x150 4 st.
- Schroefslutels 150, 250 mm 2st.
- Griptang 235 mm 1 st.

Lade 4:

- Set Allensleutels met T-hendel 2-2,5-3-4-5-6-7-8mm 8 st.
- Circlipstangenset 175mm 4 st.
- Waterpomptang 240mm 1 st.
- Plattebektang 200mm 1 st.
- Langebektang 180mm 1 st.
- Kniptang 180mm 1 st.

Lade 5:

- Hamer- en beitset 7 st.
- Kabelschoentang en kabelschoenen 161 st.
- Opbergvak met vakverdeling 1 st.

MWD43 MWD26 MWS65



Doppen 1/4" 4-14mm + 6-13mm long – bitsdoppen plat, Ph, Pz, Tpx, Hex – 43 st. + accessoires

Doppen 1/2" 10-32mm – 26 st. + accessoires

Bitsset 65st. met handvat - 6 precisieschroevendraaiers

MWS34 MWS11 MWS16



2 hex & 2 torx sets – 7 & 10 st.

Steekringsleutels 6-24mm 16st.

Steeksleutels 6-32mm 11 st.

MWSV8 MWS8 MWT3



Geïsoleerde schroevendraaierset plat & PH. 8-delig.

Schroevendraaiers TX 7 st.
TX10x100; TX15x100, TX20x100, TX25x100, TX27x100,
TX30x100, TX40x125mm

2 schroefsleutels 150-250mm
1 griptang 235mm

MWT8 MWC4 MWT4



Allensleutels met T-hendel 8st.
Hex 2-2.5-3-4-5-6-7-8mm

Circlepstangen 175mm 4 st.

Tangenset 4 st.
Waterpompplang 240mm
Platte tang 200mm
Langebektang 180mm
Kniptang 180mm

MWH7 MWT161 MWL8



Hamer- & beitset 7st.

Kabelschoentang & kabelschoenen 161 st.

Opbergvak met vakverdeling



TOOLS

Gereedschapswagen 441 dlg.

Lade 1:

- Doppen 1/4" 4-14 mm + 6-13 mm - Bitsdoppen plat, Ph, Pz, Tpx, Hex + accessoires
- Doppen 1/2" 10-32 mm + accessoires
- Bitsset 65 stuks met handvat en 6 precisieschroevendraaiers
- Kabelschoentang en kabelschoenen

Lade 2:

- TX schroevendraaiers: 10x100, 15x100, 20x100, 25x100, 27x100, 30x100, 40x125
- Schroevendraaiers plat: 3x75, 4x100, 5x125, 6x150, PH 0x75, 1x100, 2x125, 3x150
- Opbergvak met vakverdeling
- Geïsoleerde schroevendraaiersset plat en PH

Lade 3:

- 2 Allensleutelsets en 2 Torxsleutelsets
- Circlipstangen set 175 mm
- Waterpomptang 240 mm, platte tang 200 mm, langebektang 180 mm, kniptang 180 mm
- Torxset 8 sleutels met T-hendels

Lade 4:

- Allen sleutels met T-hendel: 2 - 2,5 - 3 - 4 - 5 - 6 - 7 - 8
- Steeksleutels 6-32 mm
- Set 2 schroefsluitels en 1 griptang
- 12 ratel- en steekringsleutels 8-22 mm



Lade 5:

- Hamer- en beitset
- Opbergvak met vakverdeling
- Snij- en meetset, 34 st.

Order nr.	855006612 ⓘ
Orig. nr.	MWT441G
Aantal stuks	441
Gewicht	kg 85,00
Prijs	€ 799,00

MWD43 MWD26 MWS65 MWT161



Doppen 1/4" 4-14mm + 6-13mm long – bitsdoppen plat, Ph, Pz, Tpx, Hex – 43 st. + accessoires

Doppen 1/2" 10-32mm – 26 st. + accessoires

Bitsset 65st. met handvat - 6 precisieschroevendraaiers

Kabelschoentang & kabelschoenen 161 st.

MWS7 MWS8 MWL8 MWSV8



Schroevendraaiers TX

7 st.

TX10x100; TX15x100, TX20x100, TX25x100, TX27x100, TX30x100, TX40x125mm

Schroevendraaiers plat & PH 8st.

Plat :3x75, 4x100, 5x125, 6x150; PZ #1x100, #2x125; PH #1x100, #2x125

Geïsoleerde schroevendraaierset plat & PH. 8-delig.

MWS34 MWC4 MWT4 MWTT8



2 hex & 2 torx sets – 7 & 10 st.

Allensleutels met T-hendel 8st.
Hex 2.2.5-3-4-5-6-7-8mm

Circlipstangen 175mm 4 st.

Tangset 4 st.
Waterpomptang 240mm
Platte tang 200mm
Langebektang 180mm
Kniptang 180mm

MWD43 MWD26 MWS65 MWT161



Allensleutels met T-hendel 8st.
Hex 2.2.5-3-4-5-6-7-8mm

Steekringsleutels 6-24mm 16st.

Steeksleutels 6-32mm 11 st.

2 schroefleutels 150-250mm
1 griptang 235mm

MWH7 MWL8 MWC34



Hamer- & beitelse 7st.

Snij- en meetset. 34-delig.



FOAM

444-DELIG



TOOLS

Order nr.	855006614	
Orig. nr.	MWT444FG	
Aantal stuks	443	
Gewicht	kg	79,00
Prijs	€	699,00

Order nr.	855006615	
Orig. nr.	MWT444FR	
Aantal stuks	443	
Gewicht	kg	80,00
Prijs	€	699,00

Gereedschapswagen met 7 laden en toolset 443 gereedschappen in EVA-trays

Lade 1:

- Set doppen 1/4" : 4-14mm kort, 6-13mm lang, dopbitsen plat, Ph, Pz, Tpx, Hex 43 st.
- Set doppen 1/2" : 10-32 mm 26 st.

Lade 2:

- Schroevendraaiers plat 3x75, 4x100, 5x125, 6x150 4 st.
- Schroevendraaiers PZ 1x100, 2x125 - PH 1x100, 2x125 4 st.
- Schroevendraaiers TX 10x100, 15x100, 20x100, 25x100, 27x100, 30x100, 40x125 7 st.
- Bitsset met handvat 65 st.

Lade 3:

- Set Allen-sleutels Hex en Torx 17 st.
- Ratelsteekringsleutels 8-22mm 12 st.
- Steeksleutels 6-32mm 11 st.



Lade 4:

- Schroefsleutels 150,250 mm 2 st.
- Griptang 235mm 1 st.
- Waterpomptang 240mm 1 st.
- Platte bektang 200mm 1 st.
- Lange bektang 180mm 1 st.
- Kniptang 180mm 1 st.
- Circlipstangen 175mm 4st.

Lade 5:

- Vijlenset 5st.
- Blindklinktang 2,4-4,8 mm
- Kabelschoentang + accessoires
- Assortiment kabelschoenen en rivetten.



Doppen 1/4" 4-14mm + 6-13mm long – bitsdoppen plat, Ph, Pz, Tpx, Hex – 43 st. + accessoires

Doppen 1/2" 10-32mm – 26 st. + accessoires



Schroevendraaiers plat & PH 8st.

- Plat :3x75, 4x100, 5x125, 6x150; PZ #1x100, #2x125; PH #1x100, #2x125

Schroevendraaiers TX 7 st.

- TX10x100; TX15x100, TX20x100, TX25x100, TX27x100, TX30x100, TX40x125mm

Bitsset 65st. met handvat en 6 precisieschroevendraaiers



Set Allen-sleutels Hex en Torx 17 st.

Ratelsteekringsleutels 8-22mm 12 st.

Steeksleutels 6-32mm 11 st.



2 schroefleutels 150-250mm

1 griptang

Tangenset 4st.

Waterpomptang 240mm

Platte tang 200mm

Langebektang 180mm

Kniptang 180mm

Circlipstangen 175 4st.



Vijlen 5st.

Blindklinktang 2.4-4.8mm

Kabelschoentang + ass.

Kabelschoenen & blindklinknagels

TOOLS



Gereedschapswagen met 7 laden, topbox met 4 laden en toolste 706 gereedschappen in EVA-trays.

Lade 1:

- Set doppen 1/4" : 4-14mm kort, 6-13mm lang, dopbitsen plat, Ph, Pz, Tpx, Hex 43 st.
- Set doppen 1/2" : 10-32 mm 26 st.

Lade 2:

- Schroevendraaiers plat 3x75, 4x100, 5x125, 6x150 4 st.
- Schroevendraaiers PZ 1x100, 2x125 - PH 1x100, 2x125 4 st.
- Schroevendraaiers TX 10x100, 15x100, 20x100, 25x100, 27x100, 30x100, 40x125 7 st.
- Bitsset met handvat 65 st.

Lade 3:

- Set Allen-sleutels Hex en Torx 17 st.
- Ratelsteekringsleutels 8-22mm 12 st.
- Steeksleutels 6-32mm 11 st.



Lade 4:

- Schroefsleutels 150,250 mm 2 st.
- Griptang 235mm 1 st.
- Waterpomptang 240mm 1 st.
- Platte bektang 200mm 1 st.
- Lange bektang 180mm 1 st.
- Kniptang 180mm 1 st.
- Circlipstangen 175mm 4st.

FOAM

706-DELIG

Lade 5:

- Vijlenset 5st.
- Blindklinktang 2,4-4,8 mm
- Kabelschoentang + accessoires
- Assortiment kabelschoenen en rivetten.

Lade 6:

- Set geïsoleerde schroevendraaiers plat, PH, PZ 8 pcs
- Set allensleutels met T-hendel 2-8mm 8 st.
- Set TX sleutels met T-hendel 9-40 8 st.

Lade 7:

- Precisie- bitsset
- momentsleutel 1/2" 40-200Nm
- Dopbitsen 1/2" L50mm : Hex 5-12 / M5-14 / TX 25-50
- Dopbitsen 1/2" L25mm : TX20-60 / HEX 7-19 / M5-14

Lade 8:

- Handzaag 300mm
- Hamer en nylonhamer
- Beitelset
- Cutters
- Rolmeter
- Schuifmaat 150mm
- Kraspen
- Meetlat 300 mm

Lade 9:

- Soldeerbout 60W + accessoires
- Zaklamp 80+10 lumen
- Multimeter
- Draaideinduithalers N°1-6
- Tappen M3-M12
- Boren 1-10mm



Order nr.	855006618
Orig. nr.	MWT700FG
Aantal stuks	706
Gewicht	130,00
Prijs	€ 1.299,00

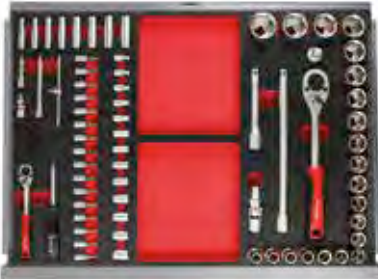

Doppen 1/4" 4-14mm
+ 6-13mm long -
bitsdoppen plat, Ph,
Pz, Tpx, Hex - 43 st. +
accessoires

Doppen 1/2"
10-32mm - 26 st. +
accessoires



Schroevendraaiers plat
& PH 8st. - Plat :3x75,
4x100, 5x125, 6x150;
PZ #1x100, #2x125;
PH #1x100, #2x125

Schroevendraaiers
TX 7 st. - TX10x100;
TX15x100,
TX20x100, TX25x100,
TX27x100, TX30x100,
TX40x125mm

Bitsset 65st. met
handvat en 6
precisieschroevendraaiers



Handzaag 300mm,
hamer & nylonhamer,
beitelset, cutters,
rolmeter, schuifmaat
150mm, kraspen,
meelfat 300mm



Set Allen-sleutels Hex en
Torx 17 st.

Ratelsteekringsleutels
8-22mm 12 st.

Steekleutels 6-32mm
11 st.



Soldeerbout 60W
+ accessoires, 250
lumen, pocket
lamp 80+10
lumen, multimeter,
draadeindhalters
N°1-6, tappen M3-
M12, boren 1-10mm



2 schroefleutels 150-
250mm
1 griptang
Tangenset 4st.
Waterpomptang
240mm
Platte tang 200mm
Langebektang 180mm
Knipptang 180mm
Circlipstangen 175 4st.



Schroevendraaiers
geisol.plat, PH, PZ
Allensleutels met
T-hendel 2-8mm 8st.
TX-sleutels met
T-hendel TX9-40 8st.



Vijlen 5st.
Blindklinktang 2.4-
4.8mm
Kabelschoentang + ass.

Kabelschoenen &
blindklinknagels



Precisiebitsset
Moment- sleutel 1/2"
40-200Nm
Dopbitsen 1/2"
L.50mm : Hex5-12/
M5-14/TX25-50
Dopbitsen 1/2"
L.25mm: TX20-60/
Hex7-19/M5-14

MEETINSTRUMENTEN

We leveren reeds bijna 100 jaar meetinstrumenten aan de industrie. Na verloop van tijd hebben we de behoeften en voorkeur van de klanten leren kennen. Onze producten zijn voortdurend ontwikkeld volgens de nieuwe productiemethoden en technologische vooruitgang.

Het merk Limit werd gecreëerd op basis van deze lange ervaring. Onze doelgroep heeft specifieke eisen voor precisie, kwaliteit, prijs en levertijd. We weten hoe op deze verzoeken te antwoorden. Met het merk Limit streven we ernaar om de Europese industrie een breed assortiment meetinstrumenten van hoge kwaliteit te bieden.

- Grote cijfers, goed leesbaar in alle omstandigheden.
- Display toont de correcte testklem en de positie van de draaiknop. Gemakkelijk te gebruiken en voorkomt fouten.
- Rubberen holster beschermt het apparaat tegen schokken en verlengt zijn levensduur.
- Handenvrij. Steunvoet aan de achterzijde, zeer handig als u met beide handen moet werken.
- Geleverd met handleiding gedrukt in uw taal en in zeer handig zakformaat.





Multimeters

Limit



Digitale multimeter met roterende functieknop voor manuele instelling.

Voor het meten van:

- DC/AC voltage
- DC stroom
- weerstand
- frequentie
- capaciteit
- temperatuur (afhankelijk van het type)

Eveneens diode test, continuïteitstest met zoemer, opslaan van gegevens en waarschuwing bij platte batterij.

Compleet geleverd met testsnoeren, temperatuursonde en handleiding. Zonder batterijen. Met holster en steunklep.

Order nr.	198650103	
Orig. nr.	LIMIT210	
AC Voltage	ACV	4-40-400-600 V
AC Voltage: resolutie/nauwkeurigheid	mV	1mV +/- 1.2% + 3mV
DC Voltage	DCV	4-40-600
DC Voltage: resolutie/nauwkeurigheid	mV	0.1 mV -4-40-300 V DCV
Batterij	V	1 x 3 (CR2032)
Capaciteit	F	4-40-400 nF-4-40-200µF
Capaciteit: resolutie/nauwkeurigheid	pF	0.001 nF/ +/- 4% + 3 pF
Frequentie	Hz	10-100 KHz
Frequentie: resolutie/nauwkeurigheid	Hz	0.01 Hz +/-0.5% +3
Maximum display		3999
Veiligheidsisolatie		CATII300V IEC61010
Weerstand	Ohm	400 Ohm-4-40-40KOhm-4-40 M Ohm
Weerstand: resolutie/nauwkeurigheid	Ohm	0.1 +/-1% + 20
Duty Cycle		0.1 - 99,9%
Frequentie: resolutie/nauwkeurigheid		+/- 0.5% + 3 digits
Batterij		1pc type CR2032
Gewicht	kg	0,19
Afmetingen (l x b x h)	mm	110 x 58 x 11
Prijs	€	34,90

Limit



Digitale multimeter met roterende functieknop voor manuele instelling.

Voor het meten van:

- DC/AC voltage
- DC stroom
- weerstand
- frequentie
- capaciteit
- temperatuur (afhankelijk van het type)
- diode test
- continuïteitstest met zoemer

Opslaan van gegevens.

Waarschuwing bij platte batterij.

Compleet geleverd met testsnoeren, temperatuursonde en handleiding. Zonder batterijen.

Order nr.	128600103	
Orig. nr.	LIMIT300	
AC Stroomsterkte	ACA	-
AC Stroomsterkte: resolutie/nauwkeurigheid	mA	-
AC Voltage	ACV	200-500V
AC Voltage: resolutie/nauwkeurigheid	mV	0,1mV/ +/-1,2% +10
DC Stroomsterkte	DCA	2000 µA-20-200 mA-10A
DC Stroomsterkte: resolutie/nauwkeurigheid	µA	0,1 µV/ +/-1% +2
DC Voltage	DCV	200-2000 mV-20-200-500 V
DC Voltage: resolutie/nauwkeurigheid	mV	0,1mV/ +/-1,2% +2
Batterij	V	1 x 9 V (6F22)
Capaciteit	F	-
Capaciteit: resolutie/nauwkeurigheid	pF	-
Dwell tachymeter: resolutie/nauwkeurigheid		-
Frequentie	Hz	-
Frequentie: resolutie/nauwkeurigheid	Hz	-
Maximum display		1999
Motor tachymeter: resolutie/nauwkeurigheid		-
Temperatuur	°C	-40 +1000
Temperatuur: resolutie/nauwkeurigheid	°C	1°C +/-1% +3
Veiligheidsisolatie		CATII300V/CATIII300V IEC61010
Weerstand	Ohm	200 Ohm-2-20-200 K Ohm-20 M Ohm
Weerstand: resolutie/nauwkeurigheid	Ohm	0,1 Ohm +/-0,8% +2
Duty Cycle		-
Gewicht	kg	0,16
Afmetingen (l x b x h)	mm	130 x 74 x 35
Prijs	€	40,50

Limit



Digitale multimeter met roterende functieknop voor manuele instelling.

Voor het meten van:

- DC/AC voltage
- DC stroom
- weerstand
- frequentie
- capaciteit
- temperatuur (afhankelijk van het type)

Eveneens diode test, continuïteitstest met zoemer, opslaan van gegevens en waarschuwing bij platte batterij.

Compleet geleverd met testsnoeren, temperatuursonde en handleiding. Zonder batterijen. Met holster en steunklep.

Order nr.	190180109	
Orig. nr.	LIMIT400	
AC Stroomsterkte	ACA	2200mA-20A
AC Stroomsterkte: resolutie/nauwkeurigheid	mA	1µA +/-1% +3
AC Voltage	ACV	220-200-750V
AC Voltage: resolutie/nauwkeurigheid	mV	1mV +/-0,8% +3
DC Stroomsterkte	DCA	2200mA-20A
DC Stroomsterkte: resolutie/nauwkeurigheid	µA	0,01 µA +/-0,8% +1
DC Voltage	DCV	400 mV-4-40-300 V
DC Voltage: resolutie/nauwkeurigheid	mV	100 µV +/-0,5% +1
Batterij	V	1x9V (6F22)
Capaciteit	F	2200 nF-20µF
Capaciteit: resolutie/nauwkeurigheid	pF	0,01nF +/-4% +3
Dwell tachymeter: resolutie/nauwkeurigheid	-	-
Frequentie	Hz	220KHz
Frequentie: resolutie/nauwkeurigheid	Hz	1 Hz +/-1,5% +5
Maximum display	-	1999
Motor tachymeter: resolutie/nauwkeurigheid	-	-
Temperatuur	°C	-40 +1000
Temperatuur: resolutie/nauwkeurigheid	°C	1°C +/-4% +4
Veiligheidsisolatie	CATIII600V/CATII1000V IEC 61010	
Weerstand	Ohm	200 Ohm-220 K Ohm-220 M Ohm
Weerstand: resolutie/nauwkeurigheid	Ohm	0,1 Ohm +/-0,8% +1
Duty Cycle	-	-
Gewicht	kg	0,54
Afmetingen (l x b x h)	mm	172 x 83 x 38
Prijs	€	61,90

Limit



Digitale multimeter met roterende functieknop voor manuele instelling.

Voor het meten van:

- DC/AC voltage
- DC stroom
- weerstand
- frequentie
- capaciteit
- temperatuur (afhankelijk van het type)

Eveneens diode test, continuïteitstest met zoemer, opslaan van gegevens en waarschuwing bij platte batterij.

Compleet geleverd met testsnoeren, temperatuursonde en handleiding, zonder batterijen. Met holster en steunklep.

Order nr.	128580107	
Orig. nr.	LIMIT500A	
AC Stroomsterkte	ACA	-
AC Stroomsterkte: resolutie/nauwkeurigheid	mA	-
AC Voltage	ACV	220-200-750V
AC Voltage: resolutie/nauwkeurigheid	mV	1mV +/-0,8% +5
DC Stroomsterkte	DCA	200 mA-10A
DC Stroomsterkte: resolutie/nauwkeurigheid	µA	0,1 µA +/-0,8% +5
DC Voltage	DCV	200 mV-220-200-1000 V
DC Voltage: resolutie/nauwkeurigheid	mV	0,1mV +/-0,5% +5
Batterij	V	1 x 9 V (6F22)
Capaciteit	F	-
Capaciteit: resolutie/nauwkeurigheid	pF	-
Dwell tachymeter: resolutie/nauwkeurigheid	-	0,1° +/-3% +5
Frequentie	Hz	-
Frequentie: resolutie/nauwkeurigheid	Hz	-
Maximum display	-	1999
Motor tachymeter: resolutie/nauwkeurigheid	-	10rpm +/-3% +5
Temperatuur	°C	-
Temperatuur: resolutie/nauwkeurigheid	°C	1°C +/-1% +3
Veiligheidsisolatie	CATIII1000V/CATII600V IEC 61010	
Weerstand	Ohm	200 Ohm-220-200 K Ohm-220 M Ohm
Weerstand: resolutie/nauwkeurigheid	Ohm	0,1 Ohm +/-0,8% +1
Duty Cycle	-	-
Gewicht	kg	0,38
Afmetingen (l x b x h)	mm	179 x 88 x 39
Prijs	€	83,50

TOOLS

Limit



Digitale multimeter met roterende functiekноп voor manuele instelling.

Voor het meten van:

- DC/AC voltage
- DC stroom
- weerstand
- frequentie
- capaciteit
- temperatuur (afhankelijk van het type)

Eveneens diode test, continuïteitstest met zoemer, opslaan van gegevens en waarschuwing bij platte batterij.

Compleet geleverd met testsnoeren, temperatuursonde en handleiding. Zonder batterijen. Met holster en steunklep.

Order nr.	128590106	
Orig. nr.	LIMIT500	
AC Stroomsterkte	ACA	2:200mA-10A
AC Stroomsterkte: resolutie/nauwkeurigheid	mA	1µA +/-1% +3
AC Voltage	ACV	2:20-200-1000V
AC Voltage: resolutie/nauwkeurigheid	mV	1mV +/-0,8% +3
DC Stroomsterkte	DCA	2:200mA-10A
DC Stroomsterkte: resolutie/nauwkeurigheid	µA	0,01 µA +/-0,8% +1
DC Voltage	DCV	200 mV-2:20-200-1000 V
DC Voltage: resolutie/nauwkeurigheid	mV	0,1 mV +/-0,5% +1
Batterij	V	1x9V (6F22)
Capaciteit	F	2:200 nF-100µF
Capaciteit: resolutie/nauwkeurigheid	pF	1pF +/-4% +3
Dwell tachymeter: resolutie/nauwkeurigheid	-	-
Frequentie	Hz	2:20KHz
Frequentie: resolutie/nauwkeurigheid	Hz	1 Hz +/-1,5% +5
Maximum display	-	1999
Motor tachymeter: resolutie/nauwkeurigheid	-	-
Temperatuur	°C	-40 +1000
Temperatuur: resolutie/nauwkeurigheid	°C	1°C +/-1% +3
Veiligheidsisolatie	CATIII 1000V/CATII 600V IEC 61010	
Weerstand	Ohm	200 Ohm-2:20-200 K Ohm-2:20 M Ohm
Weerstand: resolutie/nauwkeurigheid	Ohm	0,1 Ohm +/-0,8% +1
Duty Cycle	-	-
Gewicht	kg	0,38
Afmetingen (l x b x h)	mm	179 x 88 x 39
Prijs	€	92,90

Limit



Digitale multimeter met roterende functiekноп voor manuele instelling.

Voor het meten van:

- DC/AC voltage
- DC stroom
- weerstand
- frequentie
- capaciteit
- temperatuur (afhankelijk van het type)

Eveneens diode test, continuïteitstest met zoemer, opslaan van gegevens en waarschuwing bij platte batterij.

Compleet geleverd met testsnoeren, temperatuursonde en handleiding, zonder batterijen. Met holster en steunklep.

Met RMS functie voor metingen van niet-lineaire signalen. Connecteerbaar met pc. Geleverd met pc kabel en software.

Order nr.	153220108	
Orig. nr.	LIMIT610	
AC Stroomsterkte	ACA	600-6000 µA-60-600 mA-6-10A
AC Stroomsterkte: resolutie/nauwkeurigheid	mA	0,1 µA +/-1,2% +5
AC Voltage	ACV	6-60-600-750V
AC Voltage: resolutie/nauwkeurigheid	mV	0,01mV +/-1% +5
DC Stroomsterkte	DCA	600-6000 µA-60-600mA-6-10A
DC Stroomsterkte: resolutie/nauwkeurigheid	µA	0,1 µA +/-1% +3
DC Voltage	DCV	60-600 mV-6-60-600-1000 V
DC Voltage: resolutie/nauwkeurigheid	mV	0,1mV +/-1,0% +3
Batterij	V	1 x 9V (6F22)
Capaciteit	F	40-400 nF-4-40-400-4000 µF
Capaciteit: resolutie/nauwkeurigheid	pF	0,01 nF +/-3% +5
Dwell tachymeter: resolutie/nauwkeurigheid	-	-
Frequentie	Hz	10Hz-10MHz
Frequentie: resolutie/nauwkeurigheid	Hz	0,001 Hz +/-0,1% +4
Maximum display	-	6000
Motor tachymeter: resolutie/nauwkeurigheid	-	-
Temperatuur	°C	-
Temperatuur: resolutie/nauwkeurigheid	°C	-
Veiligheidsisolatie	CATIII 1000V/CATIV 600V, IEC 61010	
Weerstand	Ohm	600 Ohm-6-60-600 K Ohm-6-60 M Ohm
Weerstand: resolutie/nauwkeurigheid	Ohm	0,10 Ohm +/-1,2% +2
Duty Cycle	-	-
Gewicht	kg	0,30
Afmetingen (l x b x h)	mm	177 x 85 x 40
Prijs	€	143,00

Limit



Extra testkabels voor multimeters.
CATIII 600V

Order nr.	128600202	
Orig. nr.	TCAB100	
Omschrijving	extra test snoeren	
Gewicht	kg	0,06
Afmetingen (l x b x h)	mm	208 x 75 x 30
Prijs	€	8,40

Limit



Kabel voeler type K -50 - +260°C.
Lengte kabel 900mm.

Order nr.	128600301	
Orig. nr.	LIM300SENS	
Omschrijving	kabel voeler type K -50 - +260°C, lengte kabel 900mm	
Gewicht	kg	1,00
Prijs	€	9,80

Limit



Extra universele aansluiting voor verschillende doeleinden, onder andere als accessoire voor multimeters.

Order nr.	128590205	
Orig. nr.	LIM500AANSL	
Omschrijving	extra universele aansluiting voor verschillende doeleinden	
Gewicht	kg	0,26
Afmetingen (l x b x h)	mm	208 x 75 x 30
Prijs	€	10,90

Limit



Opberggas voor multimeters van Limit.
Voor Limit 500, 500A, 610.

Order nr.	198660102	
Orig. nr.	L500SB	
Gewicht	kg	0,20
Afmetingen (l x b x h)	mm	180 x 120 x 40
Prijs	€	19,50

Limit



Testkabel CAT3 1000V 10A.

Order nr.	200580108	
Lengte kabel	mm	1300
Veiligheidsklasse		CAT III 1000V
Ampère	A	10
Gewicht	kg	0,14
Prijs	€	13,50

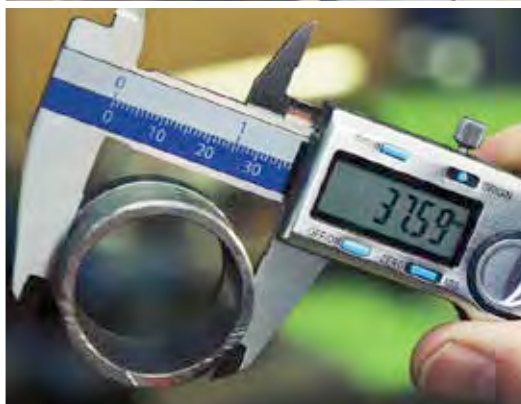

TOOLS

Limit



Digitale multi- en ampèremeter met klem.

Weergave van:

- stroom AC
- AC/DC spanning
- weerstand
- doorgang (met zoemer)
- diode
- capaciteit
- frequentie

Voorzien van datahold, laag-batterij waarschuwing.

Geleverd met testsnoeren, draagtas en handleiding. Zonder batterijen.

Order nr.	128560109	
Orig. nr.	U20	
AC Stroomsterkte	mA	220-200-400A
AC Stroomsterkte: resolutie/nauwkeurigheid	Ohm	0,1 mA/ +/-4% +5
AC Voltage	ACV	220-200-600V
AC Voltage: resolutie/nauwkeurigheid	mV	1mV/ +/-1,2%+5
DC Stroomsterkte	DCA	-
DC Stroomsterkte: resolutie/nauwkeurigheid	µA	-
DC Voltage	DCV	200 mV/220-600V
DC Voltage: resolutie/nauwkeurigheid	mV	100mV/ +/-0,8% +1
Batterij	V	2 x 1,5 V (LR06)
Frequentie	Hz	-
Maximum display	1999	
Veiligheidsisolatie	CATII600V/CATIII300V IEC61010-	
Weerstand	Ohm	200 Ohm-220-200 K Ohm 220 M Ohm
Duty Cycle	-	
Weerstand: resolutie/nauwkeurigheid	F	0,1 Ohm/ +/-1% +2
Frequentie: resolutie/nauwkeurigheid	-	
Gewicht	kg	0,26
Afmetingen (l x b x h)	mm	208 x 75 x 30
Prijs	€	54,90

Limit



Digitale multi- en ampèremeter met klem.

Weergave van:

- AC/DC stroom
- AC/DC spanning
- weerstand
- doorgang (met zoemer)
- diode
- capaciteit
- frequentie

Voorzien van datahold, laag-batterij waarschuwing.

Geleverd met testsnoeren, draagtas en handleiding. Zonder batterijen.

Order nr.	144870102	
Orig. nr.	U21	
AC Stroomsterkte	mA	40-400A
AC Stroomsterkte: resolutie/nauwkeurigheid	Ohm	0,01A / +/-2,5% + 5
AC Voltage	ACV	4-40-400-600V
AC Voltage: resolutie/nauwkeurigheid	mV	1mV / +/-1% + 5
DC Stroomsterkte	DCA	40-400A
DC Stroomsterkte: resolutie/nauwkeurigheid	µA	0,01A / +/-2% + 3
DC Voltage	DCV	400mV-4-40-400-600V
DC Voltage: resolutie/nauwkeurigheid	mV	0,1mV / +/-0,8% + 1
Batterij	V	9V (6F22)
Frequentie	Hz	10Hz-1MHz
Maximum display	3999	
Veiligheidsisolatie	CATII600V/CATIII300V IEC61010	
Weerstand	Ohm	400 Ohm-4-40-400K Ohm-4 40M Ohm
Duty Cycle	0,1% - 99,9%	
Weerstand: resolutie/nauwkeurigheid	F	0,1 Ohm / +/-1% + 2
Frequentie: resolutie/nauwkeurigheid	0,001Hz / +/-0,1% + 3	
Gewicht	kg	0,20
Afmetingen (l x b x h)	mm	210 x 76 x 30
Prijs	€	89,90

Limit



Digitale multi- en ampèremeter met klem.

Weergave van:

- AC/DC stroom
- AC/DC spanning
- weerstand
- doorgang (met zoemer)
- diode
- capaciteit
- frequentie

Dit model heeft een zeer hoge meetnauwkeurigheid dankzij de RMS-meting (voor AC stroom). Voorzien van datahold, laag-batterij waarschuwing.

Geleverd met testsnoeren, draagtas en handleiding. Zonder batterijen.

Order nr.	144860103		
Orig. nr.		LI23	
AC Stroomsterkte	mA	66-1000A	
AC Stroomsterkte: resolutie/nauwkeurigheid	Ohm	0,01A / +/-2% + 8	
AC Voltage	ACV	6,6-66-600V	
AC Voltage: resolutie/nauwkeurigheid	mV	1mV / +/-1,2% + 5	
DC Stroomsterkte	DCA	66-1000A	
DC Stroomsterkte: resolutie/nauwkeurigheid	µA	0,01A / +/-1,5% + 8	
DC Voltage	DCV	6,6-66-600V	
DC Voltage: resolutie/nauwkeurigheid	mV	0,1mV / +/-0,8% + 1	
Batterij	V	9V (6F22)	
Frequentie	Hz	660Hz-6,6-66-660KHz-6,6-66MHz	
Maximum display		6666	
Veiligheidsisolatie		CATII600V/CATIII300V IEC61010	
Weerstand	Ohm	660 Ohm-46,6-66-600K Ohm-6,6-66M Ohm	
Duty Cycle		0,1% - 99,9%	
Weerstand: resolutie/nauwkeurigheid	F	0,1 Ohm / +/-1,2% + 2	
Frequentie: resolutie/nauwkeurigheid		0,1Hz / +/-0,1% + 3	
Gewicht	kg	0,53	
Afmetingen (l x b x h)	mm	285 x 105 x 45	
Prijs	€	185,00	

Spanningstesters

Limit



Spanningsdetector. Detecteert of er al of niet spanning (AC) aanwezig is. Geen contact vereist. LED lamp en zoemgeluid (afzetbaar) in geval van contact. Automatische of manuele off. Continue batterij-controle van de LED. Geleverd met handleiding, zonder batterijen. Veiligheidsisolatie: CAT IV 1000V.

Order nr.	145010104		
Orig. nr.		LI100	
Spanning	AC	90-1000	
Batterij	V	2x 1,5 AAA	
Gewicht	kg	0,09	
Afmetingen (l x b x h)	mm	18 x 150 x 0	
Prijs	€	19,90	

Limit



Spanningstesters tot 690V.

Kenmerken:

- Met aanduiding van draaiveldrichting en onderscheid tussen fase en neutre.
- Test de werking van een aardlekschakelaar.
- Weergave van AC/DC spanning en doorgang (met buzzer).
- Aanduiding DC polariteit met + / -.
- Automatische on/off.
- Veiligheidsisolatie CAT IV 600 V, IEC 61010.
- Beschermingsgraad IP65.

Limit 110.

- Aanduiding voltage met LED-lampjes in 7 niveaus : 12-24-50-120-230-400-690V.

Limit 112.

- Aanduiding van het reële voltage op een display en eveneens via de LED-lampjes in 7 niveaus (cfr. Limit 110).

Geleverd met:

- Batterijen
- Testsnoerbescherming
- Handleiding

Order nr.	144890100	144890209
Orig. nr.	LI110	LI112
Display	Nee	Ja vanaf 24V
LED lampen	✓	✓
Spanning DC/AC	12-690	12-690
Gewicht	kg 0,33	0,33
Afmetingen (l x b x h)	mm 260 x 56 x 20	260 x 56 x 20
Prijs	€ 49,90	57,90

TOOLS

Lamp testers

TENGI TOOLS



Testlamp. Gemaakt in messing. Met naaldpunt voor doorprikken van de isolatie. Met kabel en pocketclip.

Order nr.	26460105	
Orig. nr.		9850
Lengte	mm	120
Lengte kabel	mm	520
Lengte naaldpunt	mm	10
Voor voltage	V	6-24
Gewicht	kg	0,04
Afmetingen (l x b x h)	mm	18 x 70 x 220
Prijs	€	6,70

Refratometers

Limite

NEW



Refractometer.

Manuele refractometer om het vriespunt van koelvloeistof, reinigingsvloeistof en accuzuur (om de conditie van de batterij te bepalen) te testen. Meet zowel ethyleen als propyleenglycol. De refractometer is een optisch instrument dat de concentratie van een vloeistof meet door zijn brekingsindex. Open het luik en plaats 2-3 druppels vloeistof op het prisma. Richt het voorste deel van de refractometer naar een lichtbron, pas de focus aan met het oculair, en lees dan de waarde. Eenvoudig te kalibreren en aan te passen.

Order nr.	233830108	
Ethylene glycol	°C	-50..0
Propylene glycol	°C	-50..0
Reinigings temperatuur	°C	-40..0
Batterij vloeistof	sg	1100-1400
Resolutie	°C	5
Nauwkeurigheid	°C	+5
Gewicht	kg	0,50
Prijs	€	66,90

Inspectieapparatuur

Limite



Inspectiespiegel. Verstelbare telescopische arm. Met extra magneet voor het terugvinden van onderdelen op moeilijk bereikbare plaatsen. De spiegel kan in verschillende posities geplaatst worden. Vernikkeld. Met pocket clip.

Order nr.	53070108	
Orig. nr.		INSP69-45
Diameter spiegel	mm	35
Lengte	mm	200 - 685
Lengte met magneet	mm	150 - 625
Prijs	€	31,50

Limite



Inspectiecamera. Met Pc connectie. Met led verlichting. Waterproof camera kop en flexibele arm (IP 67). Zelfdragende flexibele arm. Geleverd met magneet, haak, Pc Kabel, software. Te gebruiken in combinatie met een PC.

Order nr.	167770106	
Orig. nr.		IC90
Lengte camera arm en kop	m	0,9
Diameter camerakop	mm	14
Arm diameter	mm	9
Focus	mm	60 - ∞
Zichthoek	°	54
Pixels		640x480
Lengte USB kabel	m	2
Prijs	€	97,50

Limite



Inspectie video camera met 2,4" LCD monitor. Voor inspectie en het oplossen van problemen in muren, elektrische kasten, motoren, enz. Gemakkelijke inspectie in donkere en onbereikbare ruimtes. Geïntegreerde LED verlichting in camerakop. Het beeld kan op de monitor getoond worden. De camera en flexibele arm zijn zelfdragend en waterdicht IP67.

Accessoires zoals spiegel, haak en magneet vergemakkelijken het opvangen van gevallen voorwerpen. Geleverd met spiegel, haak en magneet. Batterijen (4x1,5V AA) en SD-kaart niet inbegrepen.

Order nr.	190120105	
Orig. nr.		IC24
Diameter camerakop	mm	9
Zichthoek	°	50
Pixels		640x480
Werktemperatuur	°C	-10... +50
Monitor		2,4" LCD
Lengte arm en camerakop	mm	900
Water -en stofbestendig	IP	67
Prijs	€	139,00

Limit



Inspectiecamera met **afneembare draadloze monitor**. Tot 10 meter vrije afstand vereenvoudigt de inspectie vooral in smalle en ontoegankelijke ruimten en wanneer u een inspectie wilt verrichten voor een lange periode. Voor de inspectie en het oplossen van problemen binnen muren, machines, elektrische kasten, riolering, enz. Het beeld kan met 180° gedraaid worden op de monitor. Waterdichte camerakop en slang. Accessoires: spiegel, haakje en magneet inbegrepen.

Order nr.	174270108 M	
Orig. nr.		DVS24
Diameter camerakop	mm	17
Zichthoek	°	50
Pixels		640x480
Batterijen		4 x 1,5V AA
Lengte arm en kop	m	0,9
LED	inch	2,4
Batterij monitor		Li batterij (herlaadbaar)
Diameter cameraarm	mm	8
Werktemperatuur	°C	-10 - +50
Prijs	€	259,00

Limit



Accessoires voor inspectiecamera's 174270108 en 190110106.

Order nr.	Orig. nr.	Omschrijving	Prijs €
174270405 M	ICH58	camerakop 5,8 mm voor inspectie camera, met slanglengte 0,9m	99,50
174270207 M	INSPT	Verlengstuk slang 2 m, aan te sluiten op camerakop van 9 mm en op de slang van 0,9 m, voor een totale lengte van 2,9 m	88,90
174270306 M	INSPH9	camerakop - 9 mm met slang lengte 0,9 m	93,50

Limit



Inspectie camera met 3,5" LCD kleurenscherm en **opname functie**. Afneembare monitor met draadloze camera-eenheid aansluiting tot 10 m. De beelden kunnen opgeslagen worden op een SD-kaart, om later op de monitor of op een PC of TV-scherm bekeken te worden. De afneembare monitor vergemakkelijkt inspectie, vooral in gesloten en moeilijk bereikbare ruimtes, en voor een lange periode. Geschikt voor inspectie en het oplossen van problemen in muren, elektrische kasten, motoren, enz. Geïntegreerde LED-verlichting in de camerakop met instelbare helderheid. De camera en de flexibele arm zijn zelfdragend en water- en stofbestendig IP67. De accessoires zoals spiegel, haak en magneet vergemakkelijken het opvangen van gevallen voorwerpen. Geleverd met 2G geheugenkaart, USB-kabel en TV-aansluitingskabel, kleurenmonitor, haak en magneet. Batterijen niet inbegrepen (4x1,5V AA).

Order nr.	190110106 M	
Orig. nr.		IC35
Zichthoek	°	50
Pixels		640x480
Werktemperatuur	°C	-10... +50
Monitor		3,5" LCD
Lengte arm en camerakop	mm	900
Prijs	€	319,00

Limit



Werkplaatsloep. Transparante acrylbuis aan de basis zorgt voor een goede verlichting.

Order nr.	53360103 M	53360202 M
Orig. nr.	LOP1960	LOP1966
Vergroting	x 5	10
Diameter focus	mm 29	29
Prijs	€ 26,50	40,90

Limit



Werkplaatsloep. Met geïntegreerd licht. Transparante acrylbuis aan de basis. Zonder batterijen geleverd (batterij 2x LR14).

Order nr.	53370102 M	
Orig. nr.		LIGHTLUPE1966
Focus	mm	29
Vergroting	x	10
Prijs	€	67,90

TOOLS

Limit



Vergrootglas met schaalverdeling lengte, hoek, radius en licht. ring voor het instellen van de focus. Geleverd zonder batterij (batterij 1x4LR44).

Order nr.	167800200 ^M		
Orig. nr.	LOP10A		
Vergroting	x	10	
Diameter focus	mm	30	
Schaal	mm	25	
Prijs	€	78,90	

Limit



Loep. Met schaalverdeling lengte. Ring voor het instellen van de focus. Transparante acrylbuis voor een goede verlichting.

Order nr.	17100108 ^M		
Orig. nr.	SCALELUPE		
Vergroting	x	10	
Diameter focus	mm	28	
Schaal	mm	20	
Prijs	€	153,00	

Limit



Meetlens met schaal en LED verlichting. Ring voor scherpstellen.

Order nr.	167800101 ^M		
Orig. nr.	LOP10B		
Vergroting	x	10	
Diameter focus	mm	30	
Schaal	mm	25	
Batterijen	1x6V 4LR44		
Prijs	€	77,50	

Limit



Loep. Met schaalverdeling. 5 veranderlijke schalen. Lengte, diepte, dikte en draad schalen. Nauwkeurigheid 0,1 mm (nauwkeurigheid dikte 0,01 mm). Ring voor focus. Transparante acrylbuis aan de basis zorgt voor een goede verlichting. Geleverd in een plastic koffer.

Order nr.	53380101 ^M		
Orig. nr.	SCALUPE2004		
Vergroting	x	10	
Diameter focus	mm	25	
Prijs	€	202,00	

Limit



Mini microscoop. Met schakelverdeling en led verlichting. Ring voor het instellen geleverd of zonder batterij v.d. focus. (batterij 3xSR44). Roterende schaalverdeling 360°.

Order nr.	167810100 ^M		
Orig. nr.	MSC20		
Vergroting	x	20	
Diameter focus	mm	6	
Schaal	mm	6	
Prijs	€	159,00	

TENGOOLS



587. Vergrootglas met handgreep of op magnetische voet. Geleverd zonder batterijen.

Order nr.	172850109 ^T	172850208 ^T
Orig. nr.	587H	587S
Type	hand	stand
Uitvergroting x	3	3
Glas diameter	mm 100	100
LED wattage	W 1,3	1,3
Batterijen	AAA/2	AAA/2
Lichtsterkte	lumen 72	72
Prijs	€ 53,50	72,90

TENGOOLS



581TMI. Telescopische spiegel met kogelkop en pocket-clip. Handvat in rode anti-slip materie.

Order nr.	112280102 ^T		
Orig. nr.	581TMI		
Lengte	mm	250 - 850	
Diameter spiegel	mm	57	
Gewicht	kg	0,08	
Afmetingen (l x b x h)	mm	30 x 57 x 250	
Prijs	€	15,50	

TENGOOLS



Telescopisch vergrootglas met kogelkop en pocket-clip. Handvat in rode anti-slip materie.

Order nr.	112270103 ^T		
Orig. nr.	581TMG		
Maximum lengte	mm	250 - 850	
Diameter vergrootglas	mm	55	
Vergroting	x	3	
Gewicht	kg	0,08	
Afmetingen (l x b x h)	mm	20 x 60 x 250	
Prijs	€	13,90	

Afstandsmeters





Laser afstandsmeter. Snel, betrouwbaar en nauwkeurig meten.

Kenmerken:

- De rode laserpunt toont precies het te meten doel aan.
- Het slimme display toont de volgende stap in multi-step metingen, de gekozen functie en de laatste drie metingen.
- Berekenen van oppervlakte en ruimte.
- Pythagoras-functie voor het meten van hoogte van op een afstand.
- Optellen en aftrekken.
- Min, max en bijhouder resultaten.
- Geheugen voor 20 metingen. mm/inch omstelbaar.
- Verlichte display. Automatisch uit.
- Conform norm EN61326-1 EMC, EN60825-1 Laser veiligheid.

Compleet geleverd met een zachte tas en handleiding. Geleverd zonder batterij.

Order nr.		178610051 
Orig. nr.		L1045
Meetbereik	m	0,2-45
Nauwkeurigheid	mm	±2
Batterijen		2x AA
Beschermingsklasse	IP	40
Werktemperatuur	°C	0 ... +40
Opslagtemperatuur	°C	-10 ... +60
Geheugens (aantal)		10
Gewicht	kg	0,10
Afmetingen (l x b x h)	mm	110 x 48 x 25
Prijs	€	114,00



Meetwiel. Meten van lange afstanden (wegenwerken). Met rem en staander. Plooibaar, met draagzak.

Order nr.		174280107 
Orig. nr.		MEASWH
Meetbereik	m	10.000
Aflezing	dm	1
Nauwkeurigheid	mm/m	+/- 0,5
Gewicht inclusief zak	kg	2,5
Prijs	€	103,00



Stevig en schokbestendig ontwerp, geschikt voor gebruik buiten en vallen van 1 m.

Geschikt om langere afstanden betrouwbaar en snel te meten. De display toont de meting in verschillende stappen, de gekozen functie en de laatste 4 metingen. Berekent oppervlakte, totale muuroppervlakte en volume. Hoogte berekening door de stelling van Pythagoras, waar de horizontale meting automatisch wordt opgeslagen. Optellen en aftrekken. Continue meting. Functie minimum en maximum. Vooraf ingestelde lengtemeting met signaal. Geheugenfunctie. Verstelbaar referentiepunt vanaf de voorkant of de hoek. Omschakelbaar tussen meter, voet en duim. Display verlichting. Automatisch uitschakelen. Geleverd met zachte draagtas, batterijen en handleiding.

Vervaardigd volgens normen EN61326-1 EMC, EN60825-1.

Order nr.		178610200 
Orig. nr.		L1070
Meetbereik	m	0.270
Nauwkeurigheid	mm	+/- 2
Geheugencapaciteit		20
Werktemperatuur	°C	-10...+40
Opslagtemperatuur	°C	-20...+60
Stof- en waterdicht	IP	54
Batterij		2 pc type AAA
Capaciteit batterij	Ah	5000
Gewicht	kg	0,18
Afmetingen (l x b x h)	mm	126 x 54 x 29
Prijs	€	159,00

Kruislijnlasers

Limit

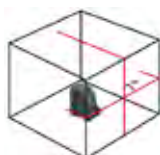

Kruislijnlaser. 1 horizontale en 1 verticale lijn.

Kenmerken:

- De verticale lijn bereikt 115 graden boven de laser
- Zelfnivellerend of niet (schuine lijnen) verticaal en/of horizontaal lijnen
- Vergrendeling voor transport
- 2 laserdiodes klasse 2M, 15 mw 635 nm

Geschikt voor:

- Kan gebruikt worden in openlucht of in sterk verlichte ruimtes met een aparte laser detector (detector 178620209 niet inbegrepen)

Voordelen:

- Compact, gemakkelijk mee te nemen

Geleverd met:

- Multifunctionele beugel
- Zachte tas
- Richtplaat
- Handleiding

Geleverd zonder batterijen (3xAA).

Order nr.		178620100 ^M
Orig. nr.		L1001HV
Aansluiting statief	inch	1/4"
Meetbereik	m	20-35 i.f.v. verlichting ruimte
Nauwkeurigheid	mm	±3mm/10m
Beschermingsklasse	IP	54
Werktemperatuur	°C	-10 ... +50
Nivelleerbereik		±3°
Werkingsijd	u	10
Gewicht	kg	0,40
Afmetingen (l x b x h)	mm	90 x 90 x 65
Prijs	€	149,00

Limit

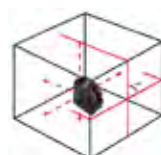

Gecombineerde kruislijn- en puntlaser. 1 horizontale en 1 verticale lijn en 5 punten.

Kenmerken:

- Zeer scherpe en duidelijke laserlijnen
- De verticale lijn bereikt 115 graden boven de laser
- Zelfnivellerend. Waarschuwing (audio en visueel) wanneer nivellering niet gelukt is
- Lijnen en punten kunnen apart of samen gebruikt worden
- Vergrendeling voor transport
- 2x15 mw, 635 nm laser voor lijnen, 1x10 mw, 635 nm voor punten

Geschikt voor:

- Kan gebruikt worden in openlucht of in sterk verlichte ruimtes met een aparte laserdetector (niet inbegrepen)

Geleverd met:

- Multifunctionele beugel (voor muur of statief)
- Richtplaat
- Zachte tas
- Handleiding

Order nr.		178631008 ^M
Orig. nr.		L1002HVP
Aansluiting		1/4" - 5/8"
Batterijen		3xAA
Beschermingsklasse	IP	54
Werktemperatuur	°C	-10... +50
Nauwkeurigheid lijn	mm	±3mm/10m
Nauwkeurigheid punten	mm	±4mm/10m
Nivelleerbereik		±3°
Werkingsijd	u	7
Gewicht	kg	1,10
Afmetingen (l x b x h)	mm	120 x 110 x 65
Prijs	€	368,00

Limit



Kruislijnlaser met 1 horizontale 360° lijn en 2 verticale lijnen.

Kenmerken:

- 1 horizontale lijn 360°
- 2 verticale lijnen die kruisen op het dak
- De lijnen kunnen samen of apart ingeschakeld worden
- zelf-nivellerend met magnetische demping
- Mechanische vergrendeling van het pendulum dient zowel als hoofdschakelaar als voor transportbeveiliging
- Knipperende lijnen en zoemer tonen aan wanneer de helling buiten zelf-nivellerend bereik is
- Zelf-nivellering kan uitgeschakeld worden om een hellend vlak te tonen.
- Kan buiten en in heldere ruimtes gebruikt worden met afzonderlijke laser detector (niet inbegrepen)
- Batterij adaptor (niet inbegrepen) kan de batterijen vervangen.
- 4 klasse 2M laser diodes 10mW 635N

Geleverd met

- Adaptor voor tripod/wandbevestiging
- Reflectorende plaat
- Soft bag
- Batterijen
- Handleiding

Order nr.	230860108	
Orig. nr.	L1003HV	
Batterijen	3x 1,5V type AA	
Bedrijfstijd	h	6
Werktemperatuur	°C	-5 +45
Stof- en waterdicht	IP	54
Horizontaalstellende nauwkeurigheid op 5m	°	1,5 mm
Laserklasse	2M	
Lasertype	10 mW - 635 nm	
Nivelleerbereik	+ 4°	
Aansluiting	inch	1/4
Gewicht	kg	0,27
Afmetingen (l x b x h)	mm	110 x 70 x 115
Prijs	€	299,00

Limit



Kruislijnlaser. 1 horizontale en 4 verticale lijnen en een neerwaartse stip.

Kenmerken

- Goed zichtbare lijnen
- Zelfnivellerend
- Keuzeschakelaar voor aparte lijnen of meerdere lijnen
- Vergrendeling voor transport
- Geïntegreerd statief voor 360° rotatie
- Fijninstelling schroeven voor draaibeweging en hoogteverstelling van de voeten

Geschikt voor:

- Kan gebruikt worden in openlucht of in sterk verlichte ruimtes met een aparte laser detector (detector 178620209 niet inbegrepen)
- Kan enkel met statief 181120106 gebruikt worden

Geleverd met

- Draagtas
- Richtplaat
- Handleiding

Geleverd zonder batterij (4xAA)

Order nr.	178640108	
Orig. nr.	L1004HV	
Beschermingsklasse	IP	54
Werktemperatuur	°C	-10 ... + 50
Nauwkeurigheid lijn	mm	±2mm/10m
Nivelleerbereik	±3°	
Werkingsstijd	u	7
Gewicht	kg	0,98
Afmetingen (l x b x h)	mm	110 x 130 x 190
Prijs	€	399,00

Limit



Roterende laser met automatische horizontale en verticale zelfnivellering.

Kenmerken:

- Verstelbare scanhoek.
- Zichtbare laserstraal.
- Mogelijk tot manuele helling.
- TILT functie, waarbij het instrument handmatig herstart moet worden als deze gekanteld werd.
- Laser detector met een dubbel indicator venster, display verlichting, verstelbare toon en verstelbare nauwkeurigheidsgraad.
- De afstandbediening stelt de helling, roteesnelheid, scanhoek en scanpositie in.
- Het instrument kan gekalibreerd worden volgens de aanwijzingen van de handleiding.
- Laserdiode klasse 2M, 1mw 635nm.

Geleverd met

- Harde plastic koffer
- Laserdetector met klemhouder
- Afstandbediening
- Muurbeugel
- Richtplaat
- Oplaadbare batterij met lader
- Handleiding

Order nr.	198640104	
Orig. nr.	L1210HV	
Bereik afstandsbediening	m	30
Draaisnelheid	rpm	0-300-600
Werktemperatuur	°C	-10...+40
Stof- en waterdicht	IP	54
Werktemperatuur	°C	-10...+40
Inclinatie sensor meetbereik	°	5
Nauwkeurigheid horizontaal	mm	+/- 1.1 mm per 10 m
Nauwkeurigheid verticaal	mm	+/- 1.5 mm per 10 m
Radius meetbereik	m	200
Werkingsstijd	u	24
Gewicht	kg	2,50
Afmetingen (l x b x h)	mm	130 x 210 x 175
Prijs	€	649,00

Limit



Stevige roterende laservoor horizontale metingen.

Kenmerken:

- Zichtbare laserstraal.
- Gemotoriseerde automatische nivellering met elektronische sensoren.
- Mogelijkheid tot manuele helling.
- TILT functie, waarbij het instrument handmatig herstart moet worden als deze gekanteld werd.
- Laserdetector met een dubbel indicator venster, display verlichting, verstelbare toon en hoge nauwkeurigheid.
- Het instrument kan gekalibreerd worden volgens de aanwijzingen in de handleiding. Laser diodes klasse 2m, 1 mw 635 nm

Geschikt voor:

- Vooral geschikt voor buitenshuis gebruik.

Geleverd met:

- Harde plastic koffer
- Laserdetector met vastbardklem
- Oplaadbare batterij met lader
- Extra batterijhouder voor losse batterijen
- Handleiding

Order nr.	178660106	
Orig. nr.	L1300H	
Nauwkeurigheid	mm	±0,7mm/10m
Beschermingsklasse	IP	66
Draaisnelheid	rpm	600
Werktemperatuur	°C	-10 ... +50
Nivelleerbereik		±5°
Radius meetbereik	m	200
Werkingsstijd	u	18
Gewicht	kg	2,50
Afmetingen (l x b x h)	mm	166 x 166 x 222
Prijs	€	999,00

Limit



Laser detector. 35m. Te gebruiken wanneer rode laserpunt niet voldoende zichtbaar. Toepasbaar voor L1002HVP en L1004HV.

Order nr.	178620209	
Orig. nr.	L1001R	
Gewicht	kg	1,00
Afmetingen (l x b x h)	mm	20 x 10 x 10
Prijs	€	83,50

Limit



Statief-aluminium. Geschikt voor diverse automatische waterpassen en laser instrumenten met schroefdraad bevestiging 5/8".

Order nr.	178680104	
Orig. nr.	TRIPOD	
Maximum hoogte	m	1,65
Gewicht	kg	3,60
Afmetingen (l x b x h)	mm	600 x 40 x 40
Prijs	€	69,90

Limit



Stevig aluminium statief. Wormwiel as voor nauwkeurige hoogtevastelling. Geschikt voor alle soorten automatische waterpassen en laser instrumenten met schroefdraad bevestiging 5/8".

Order nr.	178690103	
Orig. nr.	ROTSTAND	
Hoogtevastelling	mm	300
Maximum hoogte	m	2,30
Gewicht	kg	7,50
Afmetingen (l x b x h)	mm	1000 x 30 x 40
Prijs	€	173,00

Limit



Aluminium statief voor Lasers. Eenvoudig te dragen, vouwen en ontvouwen. Wormwiel as voor nauwkeurige hoogtevastelling. 5/8" aansluiting. Ook geschikt voor Limit 1004 HV.

Order nr.	181120106	
Orig. nr.	ALUSTAND	
Lengte geplooid	mm	600
Verstelbare hoogte	mm	300
Gewicht	kg	1,80
Prijs	€	42,90

Limit



Laser adapter met vrouwelijke 5/8" aansluiting en mannelijke 1/4" aansluiting. De adapter maakt het mogelijk om een statief met 5/8" connector te gebruiken. Aansluiting op laser met 1/4" schroefdraad.

Order nr.	181120205	
Inwendig	5/8"	
Uitwendig	1/4"	
Gewicht	kg	0,24
Prijs	€	17,50

Limit



Laserpoot om op de grond te plaatsen, of tussen vloer en plafond zonder voet te bevestigen, om plaats te sparen in kleine ruimtes.

Kenmerken:

- Geschikt voor binnenshuis gebruik, voor kruislasers of roterende lasers zoals bijvoorbeeld Limit 1210.
- Het legbord kan op de gewenste hoogte vergrendeld worden langs de gehele lengte van de staaf, die uit 5 delen bestaat, samen op de gewenste lengte geschroefd.
- Gemakkelijk transport en montage.
- Basis met veer.
- Vervaardigd uit aluminium.
- Geleverd in een koffer.

Order nr.	200570109	
Orig. nr.	LASRD	
Aansluiting statief	inch	5/8
Maximum hoogte	m	3,5
Gewicht	kg	2,97
Prijs	€	89,50

Limit



Telescopische aluminium meetstaaf. E lezing op voorkant en mm lezing op achterzijde. Elke sectie wordt automatisch vergrendeld na volledig uitbreiding. Lengte 5m.

Order nr.	178670105	
Orig. nr.	LEVRODS	
Gewicht	kg	1,00
Afmetingen (l x b x h)	mm	10 x 10 x 1000
Prijs	€	45,90

TOOLS

Tachometers

Limit



Digitale tachometer. Geschikt voor foto-meten en voor contact-meten. Meetafstand voor foto-meten: 50-150mm. Het geheugen houdt de laatst gemeten waarde, minimum waarde en maximum waarde bij. Geleverd zonder batterijen.

Order nr.	132370107 ^M	
Orig. nr.	R2000	
Batterij	4x 1,5V LR06	
Bereik: contact	m/min	0,05-2000
Bereik: foto	rpm	2,5-100000
Gewicht	kg	0,35
Afmetingen (l x b x h)	mm	124 x 35 x 20
Prijs	€	170,00

Limit



Accessoires voor R2000.

Order nr.	132370206 ^M	132370305 ^M
Orig. nr.	R2000TA	R2000ACC
Omschrijving	reflecterende tape 5x350 mm	3 meetpunten
Gewicht	kg	0,01
Prijs	€	9,80
		13,50

Limit



Tachometer Limit 2200.

Digitale tachometer/teller met optische contactloze aflezing. Richt de laser spot op een reflecterende tape of andere contrasterende oppervlakte van het roterende voorwerp en lees het toerental. Afwisselend het aantal getelde items tijdens een metingperiode.

De gemeten waarde kan vergrendeld worden en het apparaat geeft de min.-max. waarden en de gemiddelde waarde. Geleverd met reflecterende tape, batterij en handleiding.

Extra reflecterende tape 5x350 mm 13237-0206.

Order nr.	198620106 ^M	
Orig. nr.	L2200	
Afstandbereik	mm	50-200
Batterij	4pcs. 1.5V AA	
Bereik: contact	m/min	10-99999
Nauwkeurigheid	0.05% + 2 digits	
Batterij	V	1.5
Gewicht	kg	0,10
Afmetingen (l x b x h)	mm	184 x 56 x 34
Prijs	€	129,00

Vibrometers

Limit



Vibrometer Limit 4800. Voor de controle van machines, elektrische en pneumatische werktuigen. Het meten van vibraties is een middel om ergonomische letsels te voorkomen, en om het onderhoud van machines te voorzien. Gemakkelijk te gebruiken: bevestig de sensor op de machine, druk op de knop, en lees de aangeduide waarde. Geleverd met sensor en handleiding.

Order nr.	190370106 ^M	
Orig. nr.	L4800	
Afmetingen	mm	160 x 68 x 30
Diameter sensor	mm	25
Minimum aflezing	1	
Snelheid	mm/s	0 - 200
Verplaatsing	µm	2000
Versnelling	m/s ²	0 - 199
Gewicht	kg	0,20
Afmetingen (l x b x h)	mm	160 x 68 x 30
Prijs	€	535,00

Geluidsmeters

Limit



Digitale geluidsmeter - 2 verschillende metingen: A-meting: gebruikt voor omgevingsmetingen en beantwoordt aan het menselijk oor. C-meting: voor het analyseren van het geluid van machines, motoren... Een snelle meting wordt gebruikt voor kort lawaai, trage metingen worden gebruikt voor langdurige geluiden. Meetperiode van 10 sec. tot 24u. 30 Geheugengroepen. Kan op een PC aangesloten worden. Max. waarde functie, alarmfunctie wanneer een bepaalde waarde overschreven wordt. Automatisch en manueel on/off. Ingebouwde kalibratiesignaal 94dB. Standaard IEC 651 type 2, ANSI 1,4 type 2. Geleverd zonder batterijen.

Order nr.	151520103 ^M	
Orig. nr.	L17000	
Meetbereik	dB	30-130
Aflezing	dB	0,1
Nauwkeurigheid	dB	+/- 1
Meettijd snel	ms	125
Meettijd traag	sec	1
Tijd periodes	10 sec - 1 min - 5 min - 10 min - 15 min - 30 min - 1h - 8h - 24h	
Geheugengroepen	30	
Frequentie bereik	Hz	20-12500
Gewicht	kg	0,75
Afmetingen (l x b x h)	mm	236 x 63 x 26
Prijs	€	133,00

Limit



Accessoires voor Limit 7000.

Order nr.	151520202 ^M	151520301 ^M	151520400 ^M
Orig. nr.	LIM7000SOF	LIM7000CA	LIM7000
Omschrijving	Kabel + software voor pc (connectie RS-232)	Calibreertestel 94 + 114 dB	AC adaptor 230V
Gewicht	kg	0,05	0,38
Prijs	€	90,90	288,00
			8,70

Hardheidsmeters

Limit



Deze digitale hardheidsmeter meet de hardheid van zachte materialen zoals rubber, neoprene, silicone, vinyl enz. Een veerbediende-pin wordt tegen het materiaal gedrukt en de Shore A waarde verschijnt op de display. Het te meten werkstuk moet vlak zijn en de voet van de tester loodrecht op het werkstuk. Minimum diameter van het werkstuk is 12mm met eveneens 12mm afstand van het uiteinde van het meetstuk. Calibrering kan uitgaan van een teststuk. Een gemiddelde hardheid kan worden bepaald na 2 à 9 metingen. Automatische shut-off na 1 minuut. Toestel conform volgende standaards : DIN 53505, ISO 868, ASTM D 2240. Geleverd zonder batterijen.

Order nr.	144850104		
Orig. nr.	LIM40		
Batterij	V	1,5	(4 pcs LR03 AAA)
Bereik	Shore A	0-100	
Minimum dikte materiaal	mm	6	
Nauwkeurigheid	%	+/-1	
Vochtigheidsgraad	%	0-80	
Werktemperatuur	°C	0-50	
Gewicht	kg	0,17	
Afmetingen (l x b x h)	mm	150 x 50 x 30	
Prijs	€	389,00	

Limit



Draagbare Leeb hardheidsmeter voor de meest voorkomende metalen, staal, roestvrij staal, gietijzer, aluminium, messing, brons en koper.

Specificaties:

- Meten van Rockwell B en C, Vickers en Brinell hardheid
- De aparte voeler maakt het meten van grote voorwerpen en in kleine ruimtes mogelijk
- Gemakkelijk te gebruiken: Selecteer de meetrichting, de materiaalkode, en de schaal. Houd de voeler stevig tegen het voorwerp om het veermechanisme los te maken, en lees de waarde

Order nr.	230450108		
Orig. nr.	LIM4300		
Meetbereik Brinell	HB	80-647	
Meetbereik Rockwell	HRB	38-100	
Meetbereik Rockwell	HRC	20-68	
Meetbereik Vickers	HV	80-940	
Probe diameter	mm	20	
Gewicht	kg	3,82	
Afmetingen (l x b x h)	mm	120 x 60 x 28	
Prijs	€	749,00	

Thermometers

Limit



Infrarood thermometer voor het meten van buitentemperatuur zonder contact. Gecombineerd met een lamp aan de tegenovergestelde kant. Automatische shut-off na 15 seconden. Richt het apparaat naar een voorwerp en druk vervolgens op het knopje. Lees de temperatuur op de display. Geleverd zonder batterijen.

Order nr.	131560104		
Orig. nr.	LITH80		
Batterij	5x SR44/LR1154		
Meetbereik	°C	-33 - +110	
Nauwkeurigheid	+/-2,5°C alternatief +/-2,5°C		
Type	80		
Resolutie	°C	0,2	
Gewicht	kg	0,16	
Prijs	€	77,90	

Limit



Infrarood afstandsthermometer voor het meten van de meeste oppervlaktes. Automatisch shut-off na 6 seconden. Laser straal met on/off knop. Verstelbaar tussen °C en °F. Verlichte display. Limit 92en93: met USB datatransfer fiche en kabel. Waarschuwing bij bijna-lege batterij. Geleverd zonder batterijen.

Order nr.	230460107	153180104	153190103	153190202
Orig. nr.	L90	L91	L92	L93
Batterij	1 x 9V 6F22	1 x 9V 6F22	1 x 9V 6F22	1 x 9V 6F22
Emissiviteit	0,10 - 1,00	vast 0,95%	0,10 - 1,00	0,10 - 1,00
Meetop- pervlakte/ afstand	1:12	1:10	1:12	1:30
Nauwkeurig- heid	2°C of 2%	2°C of 2%	1,8°C of 1,8%	1,8°C of 1,8%
Opslagtem- peratuur	°C -20 - +65	-20 - +65	-20 - +65	-20 - +65
Temperatuur	°C -20 - +400	-18 - +380	-18 - +550	-32 - +1050
Werktemper- atuur	°C 0-50	0-50	0-50	0-50
Resolutie	°C 0,1	0,1	0,1	0,1
Gewicht	kg 0,22	0,08	0,52	0,52
Prijs	€ 95,50	109,00	189,00	449,00

TOOLS



Digitale thermometer. Geschikt om oppervlaktes, gas en vloeistof te meten. Twee inputs om te werken met 2 voelers tegelijkertijd. Er kunnen tot 99 metingen opgeslagen worden. Met display die max-min-gemiddelde en waardeverschil tussen de 2 voelers weergeeft. Met verlichte display. Verstelbaar tussen °C en °F. Waarschuwing bij lege batterij. Geschikt voor voelers type K, J en E. Geleverd met voeler type K max 260°C, pc kabel met software en handleiding. Geleverd zonder batterijen.

Order nr.	153210109	
Orig. nr.	L60	
Batterij	1 x 9V 6F22	
Opslagtemperatuur	°C	-40 - +60
Werktemperatuur	°C	-10 - +50
Resolutie	°C	0,1
Gewicht	kg	0,45
Afmetingen (l x b x h)	mm	175 x 8 x 30
Prijs	€	152,00



Accessoires voor thermometer Limit 60.

Order nr.	153210208	153210307
Orig. nr.	LIM60AIRFLU	LIM60SURF
Omschrijving	voeler voor lucht en vloeistof type K -50 - +600°C, lengte voeler 180mm, lengte kabel 1000mm	voeler voor oppervlakte type K -50 - +500°C, lengte voeler 125mm, lengte kabel 1000mm
Gewicht	kg	1,00
Prijs	€	70,90



Infrarood afstandthermometer met camera. Meet ook de omgevingstemperatuur, vochtigheid en berekent het dauwpunt. Een thermokoppel sensor type K kan aangesloten worden, om bijvoorbeeld een ander oppervlak of in een andere omgeving, of om de emissiefactor te controleren/aan te passen. Zeer enge IR-straal, 1:50, maakt de metingen heel betrouwbaar, zelfs bij kleine meetvlakken. Twee laserpunten markeren de meeteindpunten. De 2,7" LCD kleurmonitor toont het meetbereik, het meetpunt, en alle meetgegevens. Slaat max.-min. en gemiddelde op. Zowel stilstaande als bewegende beelden kunnen worden opgeslagen en daarna op het scherm afgespeeld of op een PC gedownload. Geen software nodig. Een USB kabel verbindt de thermische camera rechtstreeks met uw PC. Ingebouwde oplaadbare batterij. Geleverd met geheugenkaart 2G, USB kabel, batterijlader en handleiding. De sensor type K is niet inbegrepen.

Order nr.	190380105	
Orig. nr.	L96	
Afmetingen	mm	210 x 150 x 86
Bereik IR	°C	-40... +1000
Bereik type K	°C	-40 - +1000
Dauwpunt	°C	0... 50
Emissiviteit		0,10-1,00
Herhaalbaarheid	30 - 1000 °C	+/-0,5%
Minimum aflezing meetpunt-afstand	mm	2
Nauwkeurigheid (0 - 1370 °C)	°C	+/-0,5% +1,5°C
Omgevingstemperatuur	°C	0... 50
Vochtigheid	RH%	0... 100
Gewicht	kg	0,52
Prijs	€	489,00

Vochtmeters



Vochtmetervoor hout.

Eenvoudig in gebruik. Ideaal voor aannemers, inspectie, houtbewerkers, ...

Kenmerken:

- Meetbereik 5-42%.
- Er kunnen 7 meetwaarden geselecteerd worden, afhankelijk van het type hout.
- Wanneer de sondes in hout gedruwd worden, wordt de waarde onmiddellijk weergegeven.
- De beschermkap dient ook ter calibratie.
- Schakelt automatisch uit na 30 seconden.

Order nr.	233840107	
Orig. nr.	LIM6100	
Batterij	V	9V type 6F22
Meetbereik (hout)	%	5-42
Nauwkeurigheid	%	+2 (28%) + 5 (>28%)
Resolutie	%	1
Werktemperatuur	°C	(<80% RH) 0-40
Gewicht	kg	0,50
Prijs	€	32,50

Weegschalen



Weegschaal met wijzerplaat en analoge display.

Kenmerken:

- Roesvrij stalen weegplaat en omkasting.
- Grote en gemakkelijke te lezen schaal met veiligheidsglas.
- Nulpunt instelling tot ongeveer 5 % van de capaciteit.

Geschikt voor:

- Magazijnen, burelen en bedrijven, etc..

Order nr.	28000107	28000305	28000404
Orig. nr.	LKC38	LKC430	LKC450
Capaciteit	kg 8	30	50
Gradatie	g 20	100	200
Afmetingen weegplaat	mm 196x310	255x310	270x350
Gewicht	kg 3,00	6,50	11,00
Prijs	€ 206,00	352,00	352,00



Precisie weegschaal. Compact tafelmodel met digitaal display met grote en gemakkelijk te lezen cijfers.

Functies:

- On/off.
- Tarreren
- Tellen.
- Weegeenheden.

Kenmerken:

- RVS weegplaat met beschermend deksel.
- LEM705 touch display achtergrond verlichting.
- Batterij gevoed 2x1.5V type AAA (incl.).
- LEM710 met batterijen netadapter 230V.

Order nr.	Orig. nr.	Capaciteit	Gradatie	Nauwkeurigheid	Afmetingen weegplaat	Gewicht	Prijs
		kg	g	g	mm	kg	€
168900108	LEM705	0,50	0,1	0,1	60x60	1,20	79,90
168900207	LEM710	10	1	1	170x180	1,44	236,00
168900116	LEM712	1,2	0,1	0,1	180x170	1,95	241,00
168900124	LEM725	2,5	0,5	0,2	180x170	1,94	241,00
168900132	LEM750	5	1	0,5	180x170	1,96	241,00



Elektronische pakjes weegschalen met digitale display.

Kenmerken:

- Display en RVS weegplaat afzonderlijk.
- De weegschaal kan vrijstaand worden gebruikt of bevestigd aan een muur of op een voet.
- Duidelijk onder hoek gezette display met 25mm hoge digits met achtergrond verlichting.
- Nulfunctie, weeg unit, tarra, netto/bruto.
- Oplaadbare batterij (werkzaam 80 uur) of netstroom gevoed.

Order nr.	Orig. nr.	Capaciteit	Gradatie	Nauwkeurigheid	Afmetingen weegplaat	Gewicht	Prijs
		kg	g	g	mm	kg	€
109290031	LE230	30	10	10	315x325	38,00	345,00
109290056	LE260	60	20	20	315x325	38,00	345,00
109290072	LE2150	150	50	50	315x325	38,00	356,00
109290098	LE3150	150	50	50	450x350	68,00	472,00
109290197	LE4300	300	100	100	600x600	124,00	669,00

TOOLS



Hangweegschaal voor verschillende toepassingen.

Kenmerken:

- LKC-serie : analoog met acrilat beschermglas, vijs voor nul positie (tarra).
- CLH4-serie : electronisch met 14mm grote digits en sneltoets voor tarra positie, haak en oog in staal, totale lengte 342 mm, batterijen inclusief (2x1.5V).

Order nr.	Orig. nr.	Capaciteit	Gradatie	Gewicht	Prijs
		kg	g	kg	€
27970102	LKC0825	25	100	1,20	148,00
27970300	LKC0850	50	200	1,30	148,00
27970409	LKC08100	100	500	1,30	148,00
27970557	LKC230	200	500	3,80	635,00
27970607	LKC11	250	1000	3,30	287,00
27970615	CLH430	30	20	0,50	218,00
27970623	CLH460	60	50	0,50	218,00
27970706	CLH4150	150	100	0,50	218,00
27970805	CLH4300	300	200	0,50	218,00

Meetsets

TENGTOOLS



5-delige meetset. TC-tray.

Bestaande uit:

- digitale schuifmaat 150 mm
- micrometer 0-25 mm
- winkelhaak 150x100 mm
- stalen maatlat 150 mm
- kraspen 135 mm.

Geleverd zonder batterijen (1x SR44).

Order nr.	167500206 ⓘ	
Orig. nr.	TTCM05D	
Aantal stuks	5	
Digitale schuifmaat	mm	0-150
Micrometers	mm	0-25
Winkelhaak	mm	150x100
Maatlat	mm	150
Kraspen	mm	135
Afmetingen (l x b x h)	mm	265 x 142 x 50
Prijs	€	111,00

Limit



Meetset 6 delig in pvc opbergkoffer.

Bevat:

- Digitale schuifmaat 150 mm
- Multimeter Limit 300
- Digitale gradenboog / Waterpas
- Schroefdraadmeter metrisch/UNC
- Kraspen
- Voelermaat met 13 bladen van 0,05 tot 1,0 mm

Order nr.	230590101 ⓘ	
Orig. nr.	LMSET06	
Aantal stuks	6	
Digitale schuifmaat, meetbereik	mm	150
Prijs	€	123,00

Schuifmaten

Limit



Klassieke schuifmaat in messing.

Kenmerken:

- Lengte 100 mm
- mm en inch graduatie
- Nonius 0,1 mm
- Buitenkant van de bekken kan worden gebruikt voor binnenmeting

Order nr.	26540203 ⓘ	
Orig. nr.	CALMES100	
Meetlengte	mm	100
Lengte bek	mm	19
Prijs	€	11,90

Limit



Klassieke schuifmaat in roestvrij staal. Lengte 100mm. DIN 862.

Kenmerken:

- Gehard en geslepen.
- Met vastzetschroef, topspitsen en dieptemeter.
- Matverchroomde schaal en nonius.
- MM graduatie.
- Nonius 0,05mm.
- Geleverd in een praktisch opbergzakje.

Order nr.	60060100 ⓘ	
Orig. nr.	CALA100	
Meetlengte	mm	100
Lengte bek	mm	27
Prijs	€	57,90

Limit



Klassieke schuifmaat in werkplaatsstaal. Meetlengte 150-200mm. DIN 862.

Kenmerken:

- Gehard en geslepen.
- Met momentverstelling.
- Met topspitsen en dieptemeter.
- Matverchroomde schaal en nonius.
- MM en inch graduatie.
- Nonius 0,05mm.
- Geleverd in een praktisch opbergzakje

Order nr.	119090108 ^M	69509010 ^M
Orig. nr.	CALB150	CALB200
Meetlengte	mm 0-150	0-200
Lengte bek	mm 40	40
Prijs	€ 15,90	32,90

Limit



Klassieke schuifmaat in roestvrij staal. Lengte 150mm. DIN 862. Monobloc uitvoering.

Kenmerken:

- Gehard en geslepen.
- Met momentverstelling.
- Met topspitsen en dieptemeter.
- Matverchroomde schaal en nonius.
- MM en inch graduatie.
- Nonius 0,05mm.

Order nr.	26700302 ^M
Orig. nr.	CALMON150
Meetlengte	mm 150
Lengte bek	mm 40
Prijs	€ 25,90

Limit



Schuifmaat met meetsklok in roestvrijstaal. DIN 862.

Kenmerken:

- Gehard en geslepen.
- Met topspitsen en dieptemeter mm graduatie.
- Matverchroomde schaal en nonius.
- Geleverd in een kunststof opbergdoos.

Order nr.	52700309 ^M	52709200 ^M	52709300 ^M
Orig. nr.	CALD150	CALD20	CALD300
Meetlengte	mm 150	200	300
Lengte bek	mm 40	50	60
Aflezing	mm 0,02	0,01	0,01
Prijs	€ 63,50	83,50	135,00

Limit



Klassieke schuifmaat in roestvrij staal voor linkshandigen. DIN 862. CALL150 MO: met momentverstelling. CALL150 VZ: met vastzetschroef.

Kenmerken:

- Gehard en geslepen.
- Met topspitsen en dieptemeter.
- Matverchroomde schaal en nonius.
- MM en inch graduatie.
- Nonius 0,05mm.
- Geleverd in opbergzakje.

Order nr.	102369150 ^M	102360104 ^M
Orig. nr.	CALL150MO	CALL150VZ
Meetlengte	mm 150	150
Lengte bek	mm 40	40
Type	met momentverstelling	met vastzetschroef
Prijs	€ 42,90	47,90

Limit



Klassieke schuifmaat in roestvrij staal. Meetlengte 300mm. DIN 862.

Kenmerken:

- Met momentverstelling en vastzetschroef.
- Gehard en geslepen.
- Met topspitsen en dieptemeter.
- Matverchroomde schaal en nonius.
- MM en inch graduatie.
- Nonius 0,05mm.

Order nr.	152380101 ^M
Orig. nr.	CALD300A
Meetlengte	mm 300
Lengte onderste bek	mm 125
Lengte bovenste bek	mm 56
Prijs	€ 228,00

Limit



Klassieke schuifmaat in roestvrij staal. DIN 862.

Kenmerken:

- Met momentverstelling en vastzetschroef.
- Gehard en geslepen.
- Met topspitsen en dieptemeter.
- Matverchroomde schaal en nonius.
- MM en inch graduatie.
- Nonius 0,05mm.

Order nr.	26700708 ^M
Orig. nr.	CAL300
Meetlengte	mm 300
Lengte bek	mm 60
Prijs	€ 72,90

TOOLS

Limit



Schuifmaat in roestvrij staal voor het meten van remtrommels. DIN 862.

Kenmerken:

- Met vastzetschroef.
- Gehard en geslepen.
- Matverchroomde schaal en nonius.
- Dubbele mm schaalverdeling voor binnen- en buitenmeting.
- Aflezing 0,1 en 0,05mm.

Order nr.	109090050	109090100	109090209
Orig. nr.	CALDR340	CALDR50	CALDR60
Meetlengte	mm 40-340	50-500	50-600
Lengte bek	mm 105	150	200
Prijs	€ 222,00	358,00	488,00

Limit



Schuifmaat voor remschijven in roestvrij staal. DIN 862.

Kenmerken:

- Met fijninstelling en vastzetschroef.
- Gehard en geslepen.
- Matverchroomde schaal en nonius.
- Aflezing 0,1 mm.

Order nr.	109100107
Orig. nr.	CALDI60
Meetlengte	mm 0-60
Lengte bek	mm 85
Prijs	€ 84,90

Limit



Digitale schuifmaat voor remschijven. Roestvrij gehard staal.

Kenmerken:

- "Hold" functie om de waarde te onthouden wanneer de schuifmaat wordt verwijderd na het meten.
- Nulpunt op elk ogenblik mogelijk.
- Mm en inch graduatie.
- Batterij type V13GSV37 8SR 44.

Order nr.	139490106
Orig. nr.	SPD75RT
Meetlengte	mm 75
Lengte bek	mm 92
Hoogte cijfers	mm 11
Aflezing	mm 0,01
Prijs	€ 119,00

TOOLS

NEW



Remschijf diktemeter 0-45 mm precisie 0,25mm.

Order nr.	724561028
Orig. nr.	RD45
Meetlengte	mm 0-45
Nauwkeurigheid	mm 0.25
Prijs	€ 35,50

Limit



Drie- en vijfpuntsschuifmaat. Voor het meten van 3- en 5-zijdig gereedschap.

Kenmerken:

- In roestvrij staal.
- Met vastzetschroef.
- Gehard en geslepen.
- Matverchroomde schaal en nonius.
- MM en inch graduatie.
- Nonius 0,05mm.

Order nr.	23940109	23949900
Orig. nr.	CAL3PT	CAL5PT
Meetbereik diameter	mm 4-45	2-40
Type	3 puntsschuifmaat	5 puntsschuifmaat
Prijs	€ 113,00	96,90

Limit



Schuifmaat in roestvrij staal. Voor binnenmaatname met dubbele meetpunten. DIN 862.

Kenmerken:

- Met fijninstelling en vastzetschroef.
- Gehard en geslepen.
- Matverchroomde schaal en nonius.
- Aflezing 0,1 mm.

Order nr.	128170107
Orig. nr.	CALIID150
Meetlengte	mm 9-150
Lengte onderste bek	mm 74
Lengte bovenste bek	mm 35
Prijs	€ 144,00



Klassieke schuifmaat in roestvrij staal. Met gepunte bekken voor binnenmeting. Met fijnafstelling en vastzetschroef.

Kenmerken:

- Met bovenspitsen.
- Gehard en geslepen.
- Matverchromde schaal en nonius.
- Nonius 0,05mm + 1/128".

Geleverd:

- In een houten opbergdoos.

Order nr.	Orig. nr.	Meet- lengte	Lengte bek	Nauw- keurig- heid	D	E	B	F	Prijs
		mm	mm	mm	mm	mm	mm	mm	€
68762006	M CALI2060	200	60	0,05	20	5	40	12	87,50
68762508	M CALI25080	250	80	0,05	20	5	40	12	119,00
68763009	M CALI3090	300	90	0,05	20	5	40	12	133,00
68763010	M CALI30100	300	100	0,05	20	5	40	12	173,00
68763015	M CALI30150	300	150	0,05	20	5	40	12	287,00
68764010	M CALI40100	400	100	0,06	24	10	56	18	239,00
68764012	M CALI40125	400	125	0,06	24	10	56	18	282,00
68764015	M CALI40150	400	150	0,06	24	10	67	18	283,00
68764020	M CALI40200	400	200	0,06	24	10	18	18	355,00
68765015	M CALI50150	500	150	0,06	31	10	67	24	341,00
68765020	M CALI50200	500	200	0,07	31	10	67	24	401,00
68765025	M CALI50250	500	250	0,07	31	10	67	24	449,00
68766015	M CALI60150	600	150	0,07	31	10	67	24	390,00
68766020	M CALI60200	600	200	0,07	31	10	67	24	449,00
68766030	M CALI60300	600	300	0,12	31	10	67	24	645,00
68768015	M CALI80150	800	150	0,07	31	10	67	24	635,00
68768020	M CALI80200	800	200	0,07	31	10	67	24	699,00
68768030	M CALI80300	800	300	0,16	31	10	67	24	929,00
68768040	M CALI80400	800	400	0,16	31	10	67	24	1.119,00
68761015	M CALI10150	1000	150	0,10	31	10	67	24	599,00
68761020	M CALI10200	1000	200	0,10	31	10	67	24	839,00
68761030	M CALI10300	1000	300	0,14	31	10	67	24	1.135,00
68761220	M CALI12020	1200	200	0,14	42	10	80	24	1.075,00
68761230	M CALI12030	1200	300	0,14	42	10	80	24	1.499,00
68761520	M CALI15020	1500	200	0,20	42	10	80	24	1.525,00
68761530	M CALI15030	1500	300	0,20	42	10	80	24	1.729,00
68762020	M CALI20200	2000	200	0,30	42	10	80	24	1.909,00
68763020	M CALI30200	3000	200	0,30	50	10	80	24	3.895,00



Klassieke schuifmaat in roestvrij staal. Met gepunte bekken voor binnenmeting. Zonder bovenspitsen.

Kenmerken:

- Met fijnafstelling en vastzetschroef.
- Gehard en geslepen.
- Matverchromde schaal en nonius.
- Nonius 0,05mm + 1/128".

Geleverd:

- In een houten opbergdoos.

Order nr.	Orig. nr.	Meet- lengte	Lengte bek	Nauw- keurig- heid	D	E	F	Prijs
		mm	mm	mm	mm	mm	mm	€
23052006	M CAL2060	200	60	0,05	20	5	12	68,50
23052508	M CAL25080	250	80	0,05	20	5	12	94,50
23050057	M CAL3090	300	90	0,05	20	5	12	99,50
23053010	M CAL30100	300	100	0,05	20	5	12	110,00
23053015	M CAL30150	300	150	0,05	20	5	12	230,00
23054010	M CAL40100	400	100	0,06	24	10	18	188,00
23054012	M CAL40125	400	125	0,06	24	10	18	231,00
23054015	M CAL40150	400	150	0,07	24	10	18	251,00
23050206	M CAL50150	500	150	0,07	31	10	24	255,00
23055020	M CAL50200	500	200	0,07	31	10	24	308,00
23055025	M CAL50250	500	250	0,08	31	10	24	373,00
23056015	M CAL60150	600	150	0,08	31	10	24	304,00
23056020	M CAL60200	600	200	0,10	31	10	24	373,00
23056030	M CAL60300	600	300	0,16	31	10	24	509,00
23050404	M CAL80150	800	150	0,10	31	10	24	437,00
23058020	M CAL80200	800	200	0,10	31	10	24	525,00
23058030	M CAL80300	800	300	0,14	31	10	24	769,00
23058040	M CAL80400	800	400	0,20	31	10	24	995,00
23055003	M CAL10150	1000	150	0,12	31	10	24	575,00
23051020	M CAL10200	1000	200	0,12	31	10	24	679,00
23051030	M CAL10300	1000	300	0,16	31	10	24	885,00
23051050	M CAL10500	1000	500	0,24	31	10	24	1.339,00
23051220	M CAL12020	1200	200	0,14	42	10	24	875,00
23051230	M CAL12030	1200	300	0,14	42	10	24	1.245,00
23051520	M CAL15020	1500	200	0,16	42	10	24	1.119,00
23051530	M CAL15030	1500	300	0,16	42	10	24	1.525,00
23052020	M CAL20200	2000	200	0,22	42	10	24	1.519,00
23052030	M CAL20300	2000	300	0,30	42	10	24	1.895,00
23053020	M CAL30200	3000	200	0,30	42	10	24	3.225,00

TOOLS

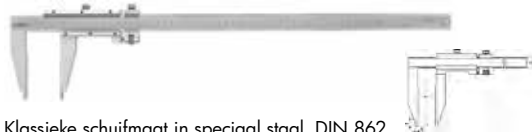

Klassieke schuifmaat in speciaal staal. DIN 862.

Kenmerken:

- Met fijnafstelling en vastzetschroef.
- Gehard en geslepen.
- Matverchromde schaal en nonius.
- Nonius 0,05mm.

Geleverd:

- In een houten opbergdoos.

Order nr.	Orig. nr.	Meet- lengte mm	Lengte bek mm	D mm	E mm	F mm	Prijs €
23045009	CALG5090	500	90	25	5	12	113,00
23045015	CALG50150	500	150	25	5	12	171,00
23040108	CALG50100	500	100	-	-	-	153,00
23040207	CALG80125	800	125	-	-	-	415,00
23041012	CALG10120	1000	120	-	-	-	333,00
23040306	CALG10125	1000	125	-	-	-	429,00
23041015	CALG10150	1000	150	32	10	18	429,00
23040405	CALG150150	1500	150	-	-	-	699,00
23041520	CALG15020	1500	200	48	15	18	735,00
23042020	CALG2020	2000	200	48	15	20	1.119,00



BESTSELLER



Digitale schuifmaat in roestvrij staal. DIN863

Kenmerken:

- mm/inch omstelbaar.
- Reset knop.
- Automatisch uit.
- Batterij 3V type CR2032.

Order nr.	190140103	190140202	190140301
Orig. nr.	CAD150N	CAD200N	CAD300N
Meetlengte	mm 150	200	300
Lengte bek	mm 40	40	40
Hoogte cijfers	mm 8	8	8
Resolutie	mm 0,01	0,01	0,01
Prijs	€ 40,90	60,50	103,00



Digitale schuifmaat in roestvrij staal. Lengte 150 mm. Met extra-grote display en anti-slip duimgreep. DIN 862.

Kenmerken:

- Gehard en geslepen.
- Met topspitsen en dieptemeter.
- On/off switch. Schakelt automatisch uit.
- Aflezing 0,01mm - 0,0005". Mm/inch omstelbaar.

Geleverd:

- In een kunststof opbergdoos
- Zonder batterijen (batterij 1x SR44).

Order nr.	132330101
Orig. nr.	SPD150B
Meetlengte	mm 150
Lengte bek	mm 40
Hoogte cijfers	mm 11
Schaalverdeling	mm 0,01
Prijs	€ 67,50



Digitale schuifmaat met grote display. DIN 862.

Kenmerken:

- Schakelen tussen mm en inch
- auto OFF
- Batterij 3V type CR2025

Order nr.	Orig. nr.	Meetlengte mm	Lengte bek mm	Hoogte cijfers mm	Resolutie mm
233810100	CAD150LN	150	40	14	0,01
233810209	CAD200LN	200	50	14	0,01
233810308	CAD300LN	300	60	14	0,01



Digitale schuifmaat in roestvrij staal. DIN863.

Kenmerken:

- Absolute functie (nulpunt en tijdelijk relatief nulpunt).
- Het originele nulpunt blijft in geheugen na uitschakelen.
- Batterij 3V - CR1632.
- Geleverd in een doos.

Order nr.	174230102
Orig. nr.	CALD150
Lengte bekken	mm 40
Hoogte cijfers	mm 8
Meetbereik	mm 0 - 150
Aflezing	mm 0,01
Prijs	€ 79,90

Limit



Digitale schuifmaat triple reading in roestvrij staal. DIN 863. Lengte 150mm.

Kenmerken:

- Gehard en geslepen.
- Met topspitsen en dieptemeter.
- Automatische switch off.
- Aflezing 0,01mm/0,0005"/1/128". Mm/inch/Inch breuk instelbaar.

Geleverd:

- In een kunststof opbergdoos.
- Zonder batterijen (batterij 1x SR44).

Order nr.	144550100	144550209
Orig. nr.	SPD150C	CADTR200
Meellengte	mm 150	200
Lengte bekken	mm 40	40
Prijs	€ 75,50	€ 67,90

Limit



Digitale schuifmaat in roestvrij staal. Lengte 150mm. DIN 862.

Kenmerken:

- Water- en olie bestendig (IP67).
- Gehard en geslepen.
- Met topspitsen en dieptemeter.
- On/off switch.
- Aflezing 0,01mm - 0,0005". Mm/inch omstelbaar.

Geleverd:

- In een kunststof opbergdoos
- Zonder batterijen (batterij 1x SR44)

Order nr.	122560105
Orig. nr.	SPD150
Meellengte	mm 150
Lengte bek	mm 40
Prijs	€ 194,00

Limit



Digitale schuifmaat in roestvrij staal. DIN 862. Lengte 500 tot 1500mm (1500mm zonder schaal).

Kenmerken:

- Gehard en geslepen.
- Zonder topspitsen.
- On/off switch.
- Aflezing 0,01mm - 0,0005". Mm/inch omstelbaar.

Geleverd:

- In een houten opbergdoos.
- Zonder batterijen (batterij 1x SR44).

Order nr.	Orig. nr.	Meellengte mm	Lengte bek mm	Prijs €
22890107	CALDI500	500	100	230,00
22890156	CALDI600	600	300	619,00
22890172	CALDI800	800	200	599,00
22890206	CALDI1000	1000	150	799,00
22899150	CALDI1500	1500	200	1.235,00

Limit



Digitale schuifmaat in roestvrij staal. Model voor linkshandigen. DIN 862. Lengte 150mm.

Kenmerken:

- Gehard en geslepen.
- Met topspitsen en dieptemeter.
- On/off switch.
- Aflezing 0,01mm - 0,0005". Mm/inch omstelbaar.

Geleverd:

- In een kunststof opbergdoos.
- Zonder batterijen (batterij 1x SR44).

Order nr.	123000152
Orig. nr.	CALDI150L
Meellengte	mm 150
Lengte bek	mm 40
Prijs	€ 96,90

Limit

Vervangbatterijen 1,50V voor digitale meetinstrumenten.



Kenmerken:

- Type AG13-V357-SR44.
- Diam. 11,5 x 5,2mm.

Order nr.	22899000
Orig. nr.	BATTLR44
Prijs	€ 6,60

Limit

Vervangbatterijen 3,0V voor digitale meetinstrumenten.



Kenmerken:

- Type 2032.
- Diam. 19,8 x 3,0mm.

Order nr.	109600304
Orig. nr.	BATT2032
Prijs	€ 5,00

TOOLS

Dieptemeters

Limit



Klassieke dieptemeter in roestvrijstaal. DIN 862. Gehard en geslepen meetpunt en meetbasis. Matverchroomde schaal in mm en nonius. Nonius 0,05mm. Geleverd in een opbergzakje.

Order nr.	Orig. nr.	Dieptemeting mm	Lengte basis mm	Prijs €
26430108	DEPA150	0-150	100	41,90
26430207	DEPA200	0-200	100	51,50
26430405	DEPA300	0-300	100	65,50
26430504	DEPA500	0-500	150	166,00

Limit



Dieptemeter in roestvrijstaal. DIN 862. Met omkeerbare schaal voor meten met haak of punt. Gehard en geslepen meetpunt en meetbasis. Matverchroomde schaal in mm en nonius. Nonius 0,05mm. Geleverd in een opbergzakje.

Order nr.	22550107	
Orig. nr.	DEPB300	
Afmetingen	mm	16x10
Dieptemeting	mm	0-300
Lengte basis	mm	150
Prijs	€	116,00

Limit



Dieptemeter in roestvrijstaal. DIN 862. Met omkeerbare schaal. Gehard en geslepen meetpunt en meetbasis. Matverchroomde schaal in mm en nonius. Nonius 0,05mm. Geleverd in een houten koffer.

Order nr.	26450106	26450205
Orig. nr.	DEPREV80	DEPREV200
Dieptemeting	mm 0-80	0-200
Lengte basis	mm 50	100
Prijs	€ 40,90	53,50

Limit



Digitale dieptemeter in roestvrijstaal. DIN 862. Gehard en geslepen. On/off switch. Aflezing 0,01mm - 0,0005". Mm/inch omstelbaar. Geleverd zonder batterijen (batterij 1x SR44).

Order nr.	21460605	21469300
Orig. nr.	DM200	DEPDIG300
Dieptemeting	mm 0-200	0-300
Lengte basis	mm 100	100
Prijs	€ 92,50	138,00

Limit



Dieptemeter met vervangbare staven met stappen van 25 mm. Lezing 0,01 mm. Zeer leesbare matverchroomde houder en gegradueerde drum. Geslepen meetvlakken basis. Met sliplknop. Koffer met instelsleutel. DIN 863.

Order nr.	73250102	
Orig. nr.	DPMC100	
Dieptemeting	mm	0-100
Lengte basis	mm	63
Diameter vervangstaaf	mm	4,5
Prijs	€	111,00

Limit



Dieptestop-voet passend op de meeste schuifmaten

Order nr.	73120107	
Orig. nr.	DEPSTOP72	
Diepte gleuf	mm	4
Breedte gleuf	mm	16,5
Lengte stop	mm	75
Prijs	€	18,50

Limit



Digitale dieptemeter. Te gebruiken bij vb. het meten van autobanden. Geleverd zonder batterijen (batterij 1x SR44).

Order nr.	132360108	
Orig. nr.	TYRETHREAD	
Dieptemeting	mm	0-25
Afmetingen meettip	mm	5x4
Afmetingen stop	mm	55x6
Prijs	€	55,50

Limit



Dieptemeter. De beweging van de meetstaaf wordt via een tandwiel naar de klok overgemaakt. Dit verzekert een hoge nauwkeurigheid. Aflezing 0,01mm. Meetstaven afzonderlijk beschikbaar en verlengt het diepteinterval van 10mm tot max 120mm.

Order nr.	26510107	
Orig. nr.	DEPDGAU	
Dieptemeting	mm	10
Diameter klok	mm	58
Prijs	€	352,00

Limit



Meestaven voor dieptemeter 26510107.

Order nr.	Orig. nr.	Lengte mm	Prijs €
26510131 ^M	MTBA10	10	12,50
26510164 ^M	MTBA20	20	12,50
26510206 ^M	MTBA30	30	12,50
26510305 ^M	MTBA60	60	12,50
26510404 ^M	MTBA90	90	12,50

Micrometers

Limit



Micrometer in roestvrijstaal. DIN863. Nonius 0,01mm. Gehard en geslepen meetvlakken. Matverchromde schaal in mm. Gesmede klem. Harde as 6,5mm. Met slijpknop en vergrendeling.

Order nr.	Orig. nr.	Meetbereik mm	Nauwkeurigheid mm	Prijs €
95380101 ^M	MICA25	0-25	+/- 0,004	40,50
95380200 ^M	MICA50	25-50	+/- 0,004	40,90
95380309 ^M	MICA75	50-75	+/- 0,005	42,50
95380408 ^M	MICA100	75-100	+/- 0,005	50,50

Limit



Micrometer in roestvrijstaal. DIN863/1. Geëmailleerde stalen beugel. Nonius 0,01mm. Gehard en geslepen meetvlakken. Matverchromde schaal. Harde as 6,5mm. Met slijpknop en vergrendeling.

Order nr.	Orig. nr.	Meetbereik mm	Nauwkeurigheid mm	Prijs €
95420105 ^M	MICAL125	100-125	+/- 0,006	55,50
95420204 ^M	MICAL150	125-150	+/- 0,006	65,50
95420303 ^M	MICAL175	150-175	+/- 0,007	73,90
95420402 ^M	MICAL200	175-200	+/- 0,007	81,50

OPTIMUM
BESCHRIJVING TOEGANG



Buitenmicrometers.

Kenmerken:

- 6-delige set van 0 tot 150mm.
- Aflezing 0,01mm
- Matverchromde schaalverdeling.
- Meetspil diam. 6,35mm.
- Meetvlakken van hardmetaal.
- Beugel met handbescherming.
- Meettrommel diam. 17mm.
- Met ratelinrichting.
- Spilspeed 0,5mm.
- Vanaf 25mm meetbereik met instellingsmaat.
- Inclusief houten kist.
- Nauwkeurigheid conform DIN 863/1.

Order nr.	713385101 ^M		
Orig. nr.	OPBM06		
Meetbereik	mm	0-150	
Aantal micrometers	6		
Micrometers	mm	0-25, 25-50, 50-75, 75-100, 100-125, 125-150	
Prijs	€	312,00	

Limit



Micrometer met teller in roestvrijstaal. DIN863. Lezing op 0,01mm. Nonius 0,001mm. Gehard en geslepen meetvlakken. Matverchromde schaal. Gesmede klem. Harde as 6,5mm. Met slijpknop en vergrendeling.

Order nr.	87499101 ^M	87499102 ^M	87499103 ^M
Orig. nr.	MICXT50	MICXT75	MICXT100
Meetbereik	mm 25-50	50-75	75-100
Nauwkeurigheid	mm +/- 0,0004	+/- 0,0005	+/- 0,0005
Prijs	€ 72,90	80,90	94,50

Limit



Micrometer met digitale aflezing. DIN 863. Absolute en toenemende meting. Gehard en geslepen. On/off switch. Aflezing 0,001mm - 0,0005". Mm/inch omstelbaar. Met slijpknop en vergrendeling. Geleverd zonder batterijen (batterij 1xSR44).

Order nr.	132680109 ^M		
Orig. nr.	MICDIGA25		
Meetbereik	mm	0-25	
Nauwkeurigheid	mm	+/- 0,004	
Prijs	€	214,00	

TOOLS

Limit



Micrometer met digitale aflezing. IP54. DIN863. Lezing 0,001mm. Absolute en toenemende meting. Gehard en geslepen. On/off switch. Mm/inch omstelbaar. Met tolerantiefunctie; knipperend symbool wanneer de waarde onder de tolerantie ligt. Geleverd zonder batterijen (batterij 1x SR44).

Order nr.	Orig. nr.	Meetbereik	Nauwkeurigheid	Prijs
		mm	mm	€
96640107	MICAD25	0-25	+/- 0,004	177,00
96640206	MICAD50	25-50	+/- 0,004	201,00
96640305	MICAD75	50-75	+/- 0,005	235,00
96640404	MICAD100	75-100	+/- 0,005	262,00

Limit



Micrometerset met 2 meetstukken. Hardmetalen meetvlakken. Lezing 0,001 mm. Diam. meetvlakken 8mm. Spoed 0,5 mm met ratelsysteem. Geëmailleerde stalen beugel en matverchroomde schaal. Digitale aflezing. DIN 863. Geleverd zonder batterijen (batterij 1x SR44).

Order nr.	96760103
Orig. nr.	MICAD150
Meetbereik	mm 0-150
Nauwkeurigheid	mm +/- 0,006
Prijs	€ 239,00

Limit



Micrometerset met verwisselbare meetstaven. Hardmetalen meetvlakken. Lezing 0,01 mm. Diameter meetvlakken 8 mm. Spoed 0,5 mm met ratelsysteem. Geëmailleerde stalen beugel en matverchroomde schaal. DIN 863.

Order nr.	95440103	95440202
Orig. nr.	MMS20150	MMS215030
Meetbereik	mm 0-150	150-300
Nauwkeurigheid	mm 0,006	0,006
Meetstukken	mm 25 - 50 - 75 - 100 - 125	150 - 175 - 200 - 225 - 275
Prijs	€ 195,00	239,00

Limit



Micrometerset met 2 meetstukken. Hardmetalen meetvlakken. Lezing 0,01 mm. Diam. meetvlakken 8mm. Spoed 0,5mm met ratelsysteem. Geëmailleerde stalen beugel en matverchroomde schaal. DIN 863.

Order nr.	Orig. nr.	Meetbereik	Nauwkeurig-Meetstukken	Prijs
		mm	heid mm mm	€
95450102	MMS2L3040	300-400	0,011 325 en 375	213,00
95450201	MMS2L4050	400 - 500	0,013 425 en 475	239,00
95450300	MMS2L5060	500 - 600	0,015 525 - 575	285,00
95450409	MMS2L6070	600 - 700	0,016 625 en 675	339,00
95450508	MMS2L7080	700 - 800	0,018 725 en 775	434,00
95450607	MMS2L8090	800 - 900	0,020 825 - 875	499,00
95450706	MMS2L90100	900 - 1000	0,020 925 - 975	559,00
95451200	MMS2L10120	1000 - 1200	0,020 1050 en 1150	1.179,00
95451400	MMS2L120140	1200 - 1400	0,024 1250 - 1350	1.319,00
95451600	MMS2L140160	1400 - 1600	0,028 1450 en 1550	1.385,00
95451800	MMS2L160180	1600 - 1800	0,031 1650 en 1750	1.535,00
95452000	MMS2L180200	1800 - 2000	0,034 1850 - 1950	1.875,00

Limit



Micrometer met conische meetpunten. Buismicrometer. Lezing 0,01 mm. Gesmede beugel en matverchroomde schaal. Geharde as 6,5 mm. Diameter raakvlak 4,8 mm. Met sliplknop en vergrendeling. DIN863.

Order nr.	95480109
Orig. nr.	MICCON25
Meetbereik	mm 0-25
Nauwkeurigheid	mm +/- 0,006
Prijs	€ 88,50

Limit



Schroefdraadmeter. Lezing 0,01 mm. Gesmede beugel en matverchroomde schaal. Voor buiten meten van draad diameter. Verwisselbare V-vormige en kegelvormige tips (niet inbegrepen). Met wrijving knop en vergrendeling. DIN 863.

Order nr.	Orig. nr.	Meetbereik	Schaalverdeling	Nauwkeurig-righeid	Prijs
		mm	mm	mm	€
132720103	MICS25	0-25	0,01	+/- 0,004	146,00
132720400	MICS50	25-50	0,01	+/- 0,004	159,00
132720509	MICS75	50-75	0,01	+/- 0,004	184,00
132720608	MICS100	75-100	0,01	+/- 0,004	198,00

Limit



Micrometer. Lezing 0,01 mm. Gesmede beugel en matverchroomde schaal. Geharde as 6,5 mm met hardmetalen meetpunten. Met slipknop en vergrendeling. DIN 863.

Order nr.	95640108 <small>M</small>
Orig. nr.	MICPT25
Meetbereik	mm 0-25
Nauwkeurigheid	mm +/- 0,004
Prijs	€ 106,00

Limit



Micrometer met afgeronde platte meetvlakken. Lezing 0,01 mm. Gesmede beugel en matverchroomde schaal. Geharde as 7,5 mm. Met slipknop en vergrendeling. DIN 863.

Order nr.	96130109 <small>M</small>
Orig. nr.	MICROUND25
Meetbereik	mm 0-25
Nauwkeurigheid	mm +/- 0,004
Hoogte x breedte been	mm 6x6
Dikte been	mm 3,5
Prijs	€ 129,00

Limit



Draadmicrometer. Lezing 0,002 mm. Gesmede beugel en matverchroomde schaal. Geharde as 6,5 mm. Fijngeslepen meetvlakken. Met slipknop en vergrendeling. DIN 863.

Order nr.	96140108 <small>M</small>
Orig. nr.	MICDR13
Meetbereik	mm 0-13
Nauwkeurigheid	mm +/- 0,004
Hoogte meting	mm 5
Prijs	€ 98,50

Limit



Speermicrometer. Voor gebruik in meettoestellen, controleapparatuur of machines. Lezing 0,01 mm. Geharde as diam. 6 mm. Fijngeslepen hardmetalen meetvlakken. Matverchroomde houder en gegradeerde drum. Met slipknop en vergrendeling. DIN 863/1.

Order nr.	73240103 <small>M</small>
Orig. nr.	MICSP25
Meetbereik	mm 0-25
Diameter x lengte	mm 12x17
Prijs	€ 65,50

Limit



Binnenmicrometer in roestvrijstaal. Nonius 0,01 mm. Gehard en geslepen meetvlakken. Matverchroomde schaal. Met slipknop en vergrendeling. Lezing 0,01 mm. DIN 863.

Order nr.	Orig. nr.	Nauwkeurigheid	Meetbereik mm	Prijs €
96150107 <small>M</small>	MMI30	+/- 0,007	5-30	89,50
96150206 <small>M</small>	MMI50	+/- 0,007	25-50	92,50
96150305 <small>M</small>	MMI75	+/- 0,008	50-75	126,00
96150404 <small>M</small>	MMI100	+/- 0,008	75-100	147,00

Limit



Micrometerhouder. Draaibaar.

Order nr.	102380102 <small>M</small>
Orig. nr.	MICHDROT
Breedte x lengte basis	mm 80x120
Klembereik	mm 7-16
Prijs	€ 40,90

Limit



Micrometerhouder. Zeer zware en stabiele uitvoering. Uit speciaal gietijzer. Voor micrometers van 20 tot 300 mm.

Order nr.	123040100 <small>M</small>
Orig. nr.	MICHD
Maximum klembereik	mm 20
Prijs	€ 31,90

Limit



Meetstaaf. Voor controleren en kalibreren van micrometers en ander meetgereedschap. Gehard hoogwaardig staal.

Order nr.	Orig. nr.	Nauwkeurigheid	Lengte mm	Prijs €
26243006 <small>M</small>	MTS25	+/- 0,5 um	25	6,80
26243105 <small>M</small>	MTS50	+/- 1 um	50	7,50
26243204 <small>M</small>	MTS75	+/- 1 um	75	8,70
26243303 <small>M</small>	MTS100	+/- 1,5 um	100	9,90
26243402 <small>M</small>	MTS125	+/- 1,5 um	125	12,50
26243501 <small>M</small>	MTS150	+/- 2 um	150	12,50
26243600 <small>M</small>	MTS175	+/- 2 um	175	14,90
26243709 <small>M</small>	MTS200	+/- 2,5 um	200	15,90

Limit



3-punts interne micrometers. Heeft drie meetvlakken wat resulteert in een betere centrering en nauwkeurigheid dan tweepuntsmeting. Lezing 0,005 mm. Hardmetalen meetvlakken met verlengstuk van 150mm. Matverchroomde schaal en gegradueerde drum. Met sliplknop. Koffer met instelring.

Order nr.	Orig. nr.	Meetbereik mm	Nauwkeurigheid mm	Dieptemeting mm	Prijs €
127810109	MM3P1216	12-16	+/- 0,004	80	199,00
127810208	MM3P1620	16-20	+/- 0,004	80	199,00
127810307	MM3P2025	20-25	+/- 0,004	90	279,00
127810406	MM3P2530	25-30	+/- 0,004	90	279,00
127810505	MM3P3040	30-40	+/- 0,004	97	304,00
127810604	MM3P4050	40-50	+/- 0,005	97	339,00
127810703	MM3P5063	50-63	+/- 0,005	114	359,00
127810802	MM3P6275	62-75	+/- 0,005	114	389,00
127810901	MM3P7588	75-88	+/- 0,005	114	395,00
127811008	MM3P87100	87-100	+/- 0,005	114	449,00

Limit



Complete set met driepuntsmicrometer en instelring. Heeft drie meetvlakken wat resulteert in een betere centrering en nauwkeurigheid dan tweepuntsmeting. Lezing 0,005 mm. Hardmetalen meetvlakken. Matverchroomde schaal en gegradueerde drum. Met sliplknop. Koffer met instelring.

Order nr.	127820108	127820207
Orig. nr.	MM3PST2050	MM3PST50100
Meetbereik mm	20-50	50-100
Aantal instelringen	2	2
Aantal micrometers	4	4
Dieptemeting mm	240-247	264
Verlengstuk mm	150	150
Prijs €	999,00	1.279,00

Limit



Set met micrometerkop en verlengstukken. Matverchroomde houder en gegradueerde drum. Geharde bolvormige hardmetalen meetvlakken. Geleverd met montagebeugel. Lezing 0,01 mm. DIN 863.

Order nr.	96230107	96230206	96230305
Orig. nr.	MMSS250	MMSS600	MMSS1400
Meetbereik mm	50-200	50-600	150-1400
Aantal	5	7	9
Prijs €	109,00	169,00	929,00

Limit



Cilindrische binnenmeetaster

Voor het meten van:

- Diameter van gaten
- Breedte van groeven

Kenmerken:

- Met vervangtips met stappen van 1 mm
- Met meetklok
- DIN 878
- Meetpunten uit hardmetaal
- Precisie 0,01 mm

Order nr.	Orig. nr.	Meetbereik mm	Diepte-meting mm	Aantal meetpunten	Prijs €
61931002	MTS1018	10-18	100	9	159,00
61931101	MTS1835	18-35	125	9	124,00
61931200	MTS3550	35-50	150	4	124,00
61931309	MTS50160	50-160	150	12	124,00
61931408	MTS160250	160-250	400	12	159,00

Limit



Cilindrische binnenmeetaster. Met meetklok. Aflezing 0,01 mm. Werkplaatsuitvoering.

Order nr.	Orig. nr.	Meetbereik mm	Aantal meetstukken	Meetstukken mm	Diameter klok mm	Meetdiepte mm	Diameter metermeetpin mm	Prijs €
110100010	BMTC1610	6-10	4	6,65 - 7,5 - 8,6 - 10	50	40	25	199,00
110100018	BMTC11018	10-18	9	10-18 mm (+0,1 mm) 21 - 24,5	40	100	34	149,00
110100035	BMTC11835	18-35	5	- 28 - 31 - 35	58	125	40	147,00
110100050	BMTC13550	35-50	3	40 - 45 - 50	58	150	-	147,00
110100100	BMTC150100	50-100	5+1	60 - 70 - 80 - 90 - 100 - verlengstuk 50 mm	58	150	52	149,00
110100160	BMTC150160	50-160	6+1	60 - 70 - 80 - 90 - 100 - 110 + 1 - verlengstuk 50 mm 120 - 140 - 160 -	58	150	52	167,00
110100250	BMTC1100250	100-250	4+1	180 + 1 - verlengstuk 80 mm 180 - 200 - 220 - 240	58	220	72	195,00
110100251	BMTC1160250	160-250	5+1	- 250 - verlengstuk 50 mm 270 - 290 - 310 - 330	58	400	72	178,00
110100450	BMTC1250450	250-450	5+1	- 350 + 1 - verlengstuk 100 mm	58	320	72	195,00

MIB



Precisie binnenmeetset 18-160mm.

Kenmerken:

- Met analoge meetklok (range 10mm)
- Schaalverdeling 0,01mm
- 3 sets :
 - 18-35 mm(diepte 125 mm, nauwkeurigheid 0,017 mm)
 - 35-50 mm(diepte 150 mm, nauwkeurigheid 0,02 mm)
 - 50-160 mm(diepte 150 mm, nauwkeurigheid 0,02 mm)
- Contactpunten in hardmetaal

Order nr.	110100102 ^M
Orig. nr.	BMTC118160
Prijs	€ 259,00

Diktemeters

Limit



Diktemeter. Voor binnenmeting. Geharde ronde meetpunten. Draaibare schaal. Geleverd in houten koffer.

Order nr.	22720205 ^M
Orig. nr.	DMINT50
Meetbereik	mm 30-50
Schaalverdeling	mm 0,01
Een toer van de naald	mm 2
Diepte meetpunt	mm 150
Diameter meetpunt	mm 2,6x1,5
Prijs	€ 194,00

Limit



Diktemeter. Pocket model. Voor zachte en harde materialen.

Order nr.	119150100 ^M
Orig. nr.	DMPOCK
Meetbereik	mm 0-10
Schaalverdeling	mm 0,01
Diameter meetvlak	mm 8
Diepte	mm 12
Prijs	€ 83,50

Limit



Diktemeter. Pocket model - extra korte hals. Voor zachte en harde materialen.

Order nr.	119160109 ^M
Orig. nr.	DMSHO
Meetbereik	mm 0-10
Schaalverdeling	mm 0,01
Diameter meetvlak	mm 10
Diepte	mm 30
Prijs	€ 93,50

Limit



Diktemeter met 120mm diepe hals. Voor zachte en harde materialen.

Order nr.	119170108 ^M
Orig. nr.	DMDEE
Schaalverdeling	mm 0,01
Diameter meetvlak	mm 10
Diepte	mm 120
Meetbereik	mm 0-10
Prijs	€ 153,00

Limit



Diktemeter met digitale aflezing. On/off switch. Aflezing 0,01 mm - 0,0005". Mm/inch omstelbaar. Met automatische uitschakeling. Reset knop. Geleverd zonder batterijen (batterij 1x SR44).

Order nr.	22940100 ^M
Orig. nr.	DMDIG
Meetbereik	mm 0-15
Schaalverdeling	mm 0,01
Tolerantie	mm +/- 0,02
Diameter meetvlak	mm 8,9
Diepte	mm 13
Prijs	€ 153,00

Limit



Deze digitale diktemeter meet de coatingdikte van bvb. verf, kunststof, porselein, koper, zink, aluminium, chroomlaag op magnetische en niet-magnetische materialen. Automatische shut-off na 2 minuten. Geleverd zonder batterijen.

Order nr.	144830106	
Orig. nr.	LIM5100	
Bereik	µm	0-1000
Aflezing 0-100 µm	µm	0,1
Aflezing 100-1000 µm	µm	1
Nauwkeurigheid	+/-2,5 µm (1-3%)	
Batterij	4 pcs 1,5V (LR03 AAA)	
Gewicht	kg	0,31
Afmetingen (l x b x h)	mm	161 x 69 x 32
Prijs	€	555,00

Limit



Deze ultrazone diktemeter meet de dikte van allerhande homogene materialen zoals metalen, glas en kunststoffen. Deze meter is aanbevolen wanneer slechts van één kant het meetstuk kan worden benaderd. Bvb. Buizen, tanks, glas, enz... Voorwaarde voor een correcte meting is een homogeen effen oppervlakte en 2 evenwijdige zijden. Automatische shut-off na 2 minuten. Geleverd zonder batterijen.

Order nr.	144840105	
Orig. nr.	LI5500	
Bereik	mm	1,2200
Aflezing	mm	0,1
Probe diameter	mm	10
Nauwkeurigheid 1-10mm	mm	+/-0,4
Nauwkeurigheid 10-100mm	mm	+/-0,4 + 1%
Nauwkeurigheid 100-250mm	mm	+/-3%
Temperatuur	°C	0 - 50
Vochtigheid	RH%	0 - 80
Batterijen	4 x 1,5V LR03 AAA	
Gewicht	kg	0,17
Prijs	€	449,00

Meetklokken

Limit



Mini meetklok. Non-shock proof. Draaibare schaal. DIN 878.

Order nr.	103900106	
Orig. nr.	DMINI	
Bereik per toer van de naald	mm	0,5
Diameter klok	mm	40
Diameter stop	mm	8
Meetbereik	mm	5
Schaalverdeling	mm	0-50 - 50-0/0,01
Lengte pin	mm	13,00
Aantal schroeven	3	
Achterkant	174240101	
Prijs	€	54,50

Limit



Meetklok. Non-shock proof. Draaibare schaal. DIN 878.

Order nr.	119110104	119110203
Orig. nr.	DNSH10	DNSH25
Bereik per toer van de naald	mm	1
Diameter klok	mm	58
Diameter stop	mm	8
Meetbereik	mm	25
Schaalverdeling	mm	0-100 - 100-0/0,01
Lengte pin	mm	21
Aantal schroeven	3	
Achterkant	174240101	174240200
Prijs	€	39,90

Limit



Meetklok. Non-shock proof. Draaibare schaal. DIN 878.

Order nr.	119120103	
Orig. nr.	DNSH0001	
Bereik per toer van de naald	mm	0,2
Diameter klok	mm	58
Diameter stop	mm	8
Meetbereik	mm	1
Schaalverdeling	mm	0-100 - 100-0/0,001
Lengte pin	mm	34,00
Achterkant	174240200	
Prijs	€	86,50

Limit



Meetklok. Shock proof. Veranderlijke schaal. DIN 878. Kan niet gebruikt worden met montagehaak.

Order nr.	43970201 M	
Orig. nr.	DSHPRSHORT	
Bereik per toer van de naald	mm	1
Diameter klok	mm	58
Diameter stop	mm	8
Meetbereik	mm	10
Schaalverdeling	mm	0-100 - 100-0/0,01
Lengte pin	mm	21,00
Aantal schroeven		3
Achterkant		174240101
Prijs	€	64,90

Limit



Meetklok. Shock proof. Veranderlijke schaal. DIN 878.

Order nr.	119130102 M	119130201 M
Orig. nr.	DSHPRL50	DSHPRL80
Bereik per toer van de naald	mm	1
Diameter klok	mm	58
Diameter stop	mm	8
Meetbereik	mm	50
Schaalverdeling	mm	0-100 - 100-0/0,01
Lengte pin	mm	58
Aantal schroeven		4
Achterkant		174240200
Prijs	€	147,00

Limit



Meetklok voor groter meetbereik met afzonderlijk naald voor volledige mm. Koperen behuizing. Din 878. Nauwkeurigheid 0,1mm.

Order nr.	87620050 M	
Orig. nr.	DJOH30	
Bereik per toer van de naald	mm	10
Diameter klok	mm	58
Diameter stop	mm	8
Meetbereik	mm	30
Schaalverdeling	mm	0-100
Prijs	€	144,00

Limit



Digitale meetklok. Met tolerant functie. Absolute en toenemende meting. Reset knop. Mm/inch omstelbaar. Din 878. Met automatische uitschakeling. Geleverd zonder batterijen (batterij 1x CR 2025).

Order nr.	151300100 M	151300209 M	151300308 M
Orig. nr.	DDIG125	DDIG25	MD125
Nauwkeurigheid	mm	0,02	0,02
Meetbereik	mm	0-12,5	0-25
Lengte pin	mm	24	34
Aantal schroeven		4	4
Achterkant		174240200	174240200
Aflezing	mm	0,01	0,01
Hoogte cijfers op display	mm	12	12
Diameter schijf	mm	57	57
Dikte meter	mm	26	26
Diameter pin	mm	8	8
Prijs	€	102,00	166,00

Limit



Hefarm en magnetisch voetje voor meetklokken. Montageopening diameter 8mm.

Order nr.	53180204 M	53180303 M
Orig. nr.	DHE	DMAGVO
Omschrijving	Hefarm	Magnetisch voetje
Prijs	€	19,50

Limit



Achterkant voor Limit meetklok diameter 58 mm. De diameter van de montageopening is 6,5 mm.

Order nr.	174240101 M	174240200 M
Orig. nr.	DVERS3	DVERS4
Aantal schroeven	3	4
Prijs	€	7,30

Limit

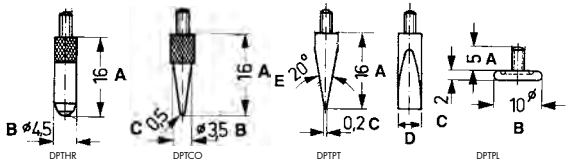

Meetpunten voor meetklokken

Order nr.	53181004 M	53181103 M	53181202 M	53181301 M
Orig. nr.	DPTHHR	DPTCO	DPTPT	DPTPL
Tip	Half rond	Konisch	Plat	Plat
Afmeting A	16	16	16	5
Afmeting B	4,5	3,5	-	10
Afmeting C	-	0,5	0,2	2
Afmeting D	-	-	5	-
Afmeting E	mm	-	20°	-
Prijs	€	9,60	14,90	19,50

Binnenmeettasters

Limit



Universele binnenmeettaster. Meetunit met hardmetalen meettop. Automatische omkering van het meetpunt. Met zwaluwstaart-opname. Inclusief opspanschacht 6H6 - 8H6.

Order nr.	22590103 M	
Orig. nr.	BMTT	
Meetbereik	mm	0,8
Schaalverdeling	mm	0,01
Schaalverdeling	0-40-0	
Diameter klok	mm	30
Lengte pin	mm	15
Diameter stop	mm	6-8
Prijs	€	76,50

TOOLS

Limit



Universele binnenmeettaster. DIN2270. Stootvast. Meetunit met hardmetalen meettop. Automatische omkering van het meetpunt. Met zwaluwstaart-opname. Inclusief opspanschacht 6H6 - 8H6.

Order nr.	22590200 M	22590300 M	22590400 M	22590500 M
Orig. nr.	BMTH01	BMTV01	BMTH002	BMTV002
Meetbereik	mm 0,8	0,8	0,2	0,2
Schaalverdeling	mm 0,01	0,01	0,002	0,002
Type	horizontaal	verticaal	horizontaal	verticaal
Schaalverdeling	0-40-0 0-40-0 0-100-0 0-100-0			
Diameter klok	mm 30	30	40	40
Lengte pin	mm 14,5	14,5	11,5	11,5
Prijs	€ 74,90	80,90	122,00	129,00

Limit



Digitale binnenmeettaster. Meet in 2 richtingen. mm en inch omstelbaar. Geleverd zonder batterijen (batterij 1 x SR44).

Order nr.	167560101 M	
Orig. nr.	BMTDIG	
Meetbereik	mm	0,5
Schaalverdeling	mm	0,001
Nauwkeurigheid	mm	0,009
Prijs	€	282,00

Kantentasters

Tschorn



De 3-D taster onderscheidt zich door een zeer slank en attractief design. De precisie en veelzijdige inzetmogelijkheden maken het snel en eenvoudig bepalen van werkstuk nulpunten en lengtematen mogelijk. In zowel de X- Y- als Z-as een gelijke aflezing op de meetklok. Slankste tastereenheid ter wereld met een diameter van 26 mm. Europese kwaliteit.

Om beschadiging van de 3-D taster te voorkomen, heeft de tasterpunt een grote uitslag (X/Y) welke is begrensd met een mechanische eindaanslag. Het "breekpunt" boven in de tasterpunt voorkomt beschadiging van het gepatenteerde binnenwerk van de taster, indien deze toch over het mechanische eindaanslagpunt gevoerd wordt. Tasterpunten (lang en kort) zijn eenvoudig zelf uit te wisselen. De 3-D taster wordt geleverd met de standaard tasterpunt ø 3 mm, in een mooie kunststof koffer!

Order nr.	713539001 M	
Orig. nr.	3DCEN	
Nauwkeurigheid	mm	0,01
Diameter opnameschacht	mm	12
Diameter taster	mm	3
Prijs	€	399,00



Mechanische kantentaster. Ideaal om uw referentievlak / werkstuknulpunt eenvoudig vast te leggen. Werking: als de kantentaster het werkstuk aanraakt, lijkt de kantentaster uit een stuk vervaardigd, wanneer de taster en de schacht in lijn komen te staan, glijdt de taster uit zijn draaicenter. Nu bevindt zich de spindel center 5 mm weg van het te meten oppervlak. Tpm 450-600, nauwkeurigheid van nulpunt tot punt is binnen de 0.003 mm.

Order nr.	790003964
Orig. nr.	KTM104
Prijs	€ 5,40



Optische kantentaster met geluid. Ideale tool om uw werkstuknulpunt te bepalen en te gebruiken in meetopstellingen. Werking: als het rode licht oplicht, wordt ook de beeper geactiveerd. Zo blijft u ten allen tijde gewaarschuwd. Voorbeeld: als u een diep gat dient op te meten en u kunt het licht niet meer zien, hoort u nog steeds het beep geluid. Rondlooptnauwkeurigheid binnen de 0.005 mm.

LR 1 N batterijen. 1 set batterijen inbegrepen.

Order nr.	790003955
Orig. nr.	KT120
Prijs	€ 29,90



Hoogtemeter. Analoog hoogte-meetapparaat met meetklok en magneetvoet voor snel en nauwkeurig bepalen van de Z-as positie tussen spindel en werkstuk. Referentiehoogte 50mm. Met kalibratie mechanisme.

Order nr.	153200100
Orig. nr.	DDQ50
Hoogte	mm 50
Schaalverdeling	mm 0,01
Prijs	€ 356,00

Winkelhaken



Winkelhaak. Platte uitvoering. Werkplaatsstaal. Verzinkt. Vervaardigd uit 1 stuk. (1 250-1 500-2000mm : gepolierd - niet-verzinkt.)

Order nr.	Orig. nr.	Lang been mm	Kort been mm	Prijs €
25389010	WHP10070	100	70	8,10
25389020	WHP150100	150	100	8,90
25380304	WHP200130	200	130	10,50
25389030	WHP250160	250	165	11,90
25380502	WHP300180	300	180	12,90
25389040	WHP400230	400	230	14,90
25380700	WHP500280	500	280	18,50
25380809	WHP600330	600	330	24,90
25389050	WHP750375	750	375	28,50
25381005	WHP5001000	1000	500	41,90
25389060	WHP1250625	1250	625	73,50
25381104	WHP1500750	1500	750	135,00



Winkelhaak. Platte uitvoering. DIN 875/2. Werkplaatsstaal. Verzinkt.

Order nr.	Orig. nr.	Lang been mm	Kort been mm	Prijs €
25331505	WHVL7550	75	50	15,90
25331604	WHVL10070	100	70	15,90
25331703	WHVL150100	150	100	23,90
25331802	WHVL200130	200	130	32,90
25339250	WHVL250	250	165	25,50
25331901	WHVL300200	300	200	67,90
25339500	WHVL500	500	250	65,90
25332008	25332008	400	265	87,50



Winkelhaak 100x70mm Workshop Quality. DIN 875/2.

Order nr.	162460208
Orig. nr.	WHBL10070
Lang been	mm 100
Kort been	mm 70
Lengte basis	mm 20x9
Lengte been	mm 20x1.5
Prijs	€ 21,90

Limit



Winkelhaak. Uitvoering met voet. Werkplaatsstaal. Verzinkt. Vervaardigd uit 1 stuk. (1250mm : gepolierd - niet-verzinkt.)

Order nr.	Orig. nr.	Lang been mm	Kort been mm	Prijs €
25341000	WHV10070	100	70	11,90
25341500	WHV150100	150	100	13,90
25342000	WHV200130	200	130	16,50
25342500	WHV250160	250	165	19,50
25343000	WHV300180	300	180	23,90
25344000	WHV400230	400	230	27,90
25455000	WHV500280	500	280	36,90
25456000	WHV600330	600	330	51,50
25457500	WHV750375	750	375	59,50
25450100	WHV5001000	1000	500	80,90
25450125	WHV1250625	1250	625	176,00

Limit



Winkelhaak. Uitvoering met voet. DIN 875/2. Werkplaatsstaal. Verzinkt.

Order nr.	Orig. nr.	Lang been mm	Kort been mm	Prijs €
120110075	WH275	75	50	14,90
120110100	WH2100	100	70	16,50
120110150	WH2150	150	100	23,50
120110200	WH2200	200	130	26,90
120110250	WH2250	250	165	36,90
120110300	WH2300	300	175	47,50
120110400	WH2400	400	200	77,50
120110500	WH2500	500	250	98,50
120110750	WH2750	750	375	144,00

Limit



Winkelhaak. Uitvoering met voet. Werkplaatsstaal. Vervaardigd uit 1 stuk. Din 875/2.

Order nr.	Orig. nr.	Lang been mm	Kort been mm	Prijs €
25342007	WH210075	100	70	28,50
25342106	WH2200130	200	130	45,50
25342205	WH2300200	300	200	78,90
25342304	WH2400265	400	265	147,00

Limit



Winkelhaak met scherpe hoeken. Gehard staal. Gepolierde hoeken. DIN875/00.

Order nr.	52171402		
Orig. nr.	WH875/00		
Lang been	mm	200	
Kort been	mm	130	
Prijs	€	69,90	

Limit



Blokwinkelhaak. Uit staal. Werkplaatskwaliteit. Met zware blok-basis. Geslepen aan beide zijden.

Order nr.	Orig. nr.	Lang been mm	Kort been mm	Prijs €
25319100	BWH10070	100	70	15,50
25319125	BWH12575	125	75	26,90
25319150	BWH150100	150	100	23,90
25319200	BWH200130	200	125	27,90
25319250	BWH250160	250	160	33,90
25319300	BWH300200	300	200	43,50

Limit



Verstelbare winkelhaak. Geslepen staal. Verzinkt. Met vastzetschroef.

Order nr.	25449010	25449020
Orig. nr.	WHG150	WHG250
Lengte been	mm 150	250
Prijs	€ 19,50	26,90

Limit



Hartzoeker. Werkplaatsstaal. Kan worden gebruikt als blokwinkelhaak of T-haak. Graduatie in mm. Matverchromd. Te gebruiken voor markeren van centers, plaateneinden of ronde stukken.

Order nr.	Orig. nr.	Lengte blad mm	Lengte basis mm	Voor assen diameter mm	Prijs €
25429100	HZ10070	100	70	90	44,50
25429150	HZ150130	150	130	200	51,50
25420209	HZ200150	200	150	220	70,90
25429250	HZ250160	250	160	230	95,50
25429300	HZ300180	300	180	280	124,00

Limit



Verstelbare stop op gegradueerde metalen maatlat. Tolerantie volgens DIN 875/2.

Order nr.	151250107	151250206
Orig. nr.	WHLA10070	WHLA150100
Lengte winkelhaak	mm 100	150
Lengte aanpasbare stop	mm 70	70
Prijs	€ 22,50	25,50

Limit



Gecombineerd precisie winkelhaak. Verschuifbare en vastzetbare middelpuntzoeker en rechte hoek. Met waterpas op hoekmeter. 300mm maatlat is gegradueerd aan beide zijden mm en inch. Met kraspen.

Order nr.	61380101
Orig. nr.	CWH3002
Prijs	€ 269,00

Limit



Gecombineerde winkelhaak. Met gradenbooghoek en middelpuntzoeker. Waterpas op de hoekmeter en gradenboog. Maatlat is gegradueerd aan beide zijden in mm en inch. Eenvoudig om hoogte, diepte en de 45° - 135° hoek of center te meten.

Order nr.	119180107
Orig. nr.	CWH3
Gradenboog	° 0-180
Meeflat lengte	mm 300
Hoekmeter	mm 110
Middelpuntzoeker	mm 63
Prijs	€ 98,50

Limit



Extra stalen regel 600mm voor gecombineerde winkelhaak 119180107

Order nr.	119180206
Orig. nr.	CWHLA
Prijs	€ 25,50

Limit



Set van 12 hoekplaten. Voor meting, inspectie en instellen van machines, snijgereedschappen of gradenboog. In kwaliteitsstaal, geaard en gehard. De platen zijn licht magnetisch zodat ze makkelijk kunnen geplaatst worden. Nauwkeurigheid van de hoek +/- 0,01mm per 100mm. Geleverd in een stevige plastic doos.

Order nr.	153230107
Orig. nr.	LPH12
Hoek	° 1/4 - 1/2 - 1 - 2 - 3 - 4 - 5 - 10 - 20 - 25 - 30
Lengte	mm 76
Prijs	€ 104,00

TENGTOLS



ALU NEW

Aluminium schrijfhaak. Blad uit roestvrij staal 1,5 x 45 mm. Handvat uit geanodiseerd aluminium, met 18 mm breed gegroefd oppervlak. Diep gegraveerd en slijtvast.

Order nr.	237780101	237780200	237780309
Orig. nr.	SQAA200	SQAA250	SQAA300
Lengte blad	mm 200	250	300
Tolerantie	° +/- 0,03	+/- 0,03	+/- 0,03
Prijs	€ 21,40	22,80	24,90

TENGTOLS



NEW KUNSTSTOF

Kunststof schrijfhaak. Blad uit roestvrij staal 1,0 x 45 mm. Handvat uit glasvezelversterkte kunststof, met 18 mm breed gegroefd oppervlak. Diep gegraveerd en slijtvast.

Order nr.	237770102	237770201
Orig. nr.	SQAP250	SQAP300
Lengte blad	mm 250	300
Tolerantie	° +/- 0,06	+/- 0,06
Prijs	€ 11,20	11,80

TENGTOLS



BOUW

NEW



Duplicateer hoeken



Controleer de consistentie van de hoeken

Schuifzweihaak. Met recht blad uit roestvrij staal. Om hoeken te controleren en overbrengen.

Order nr.	237790100
Orig. nr.	AB200
Prijs	€ 5,70

Flenshoekhaken

Limit



Flenshoekhaak. Uit speciaal staal. Verzinkt.

Order nr.	Orig. nr.	Afmetingen	Prijs
		mm	€
25410200	FH300	300x300	28,50
25410309	FH400	400x400	34,90
25410408	FH500	500x500	44,50
25419600	FH600	600x600	51,50
25419800	FH800	800x800	88,50
25419010	FH1000	1000x1000	145,00
25419020	FH1500	1500x1500	249,00

Passers

Limit



Precisie-afschrijflineaal. Vlakke uitvoering. Werkplaatstaal. Matverchroomde mmschaalverdeling. Gehard snijvlak.

Order nr.	Orig. nr.	Verstelbare lengte mm	Breedte mm	Prijs €
23790108	ASL200	200	40	28,50
23799010	ASL250	250	40	34,90
23790207	ASL300	300	40	35,90

Limit



Stokpasser. Roestvrijstaal. Met vastzetschroef. Matverchroomde schaal en nonius. Geharde punt. Graduatie in mm. Nonius 1/10mm van lengte 39mm.

Order nr.	Orig. nr.	Lengte mm	Maximum diameter mm	Prijs €
24200107	STP50005	500	1000	439,00
24202004	STP5005	500	1000	399,00
24202103	STP1000	1000	2000	559,00
24202202	STP1500	1500	3000	699,00
24202301	STP2000	2000	4000	969,00

Limit



Accessoire voor stokpassers SCRG200.

Order nr.	Orig. nr.	Accessoire	Prijs €
97170203	SCRG200PT	Extra schrijfpunt	4,90

Limit



Gecombineerde passer en schuifmaat. Speciaal staal. Gehard en geslepen. Matverchroomde schaal en nonius 0,1mm.

Order nr.	Orig. nr.	Lengte mm	Lengte punten mm	Prijs €
24360208	COMGA	200	45	119,00

Limit



Stokpasser. Speciaal staal. Met fijnafstelling en vastzetschroef. Matverchroomde schaal en nonius 0,1mm. Gehard punt diam. 5mm. Graduatie in mm.

Order nr.	Orig. nr.	Lengte staaf mm	Prijs €
24130205	STP3001	300	69,50

Limit



Accessoire stokpassers STP3001.

Order nr.	Orig. nr.	Accessoire	Prijs €
24130304	STPPT1	Extra markeerpunt diameter 5x56mm	26,50

Limit



Stokpasser. Rechthoekige staaf uit speciaal staal. Graduatie in mm. Nonius 0,05 mm.

Order nr.	Orig. nr.	Lengte mm	Maximum diameter mm	Prijs €
24200107	STP50005	500	1000	439,00
24202004	STP5005	500	1000	399,00
24202103	STP1000	1000	2000	559,00
24202202	STP1500	1500	3000	699,00
24202301	STP2000	2000	4000	969,00

Limit



Passer voor potlood. Speciaal staal. Potlood niet inbegrepen.

Order nr.	Orig. nr.	Maximum capaciteit mm	Lengte mm	Prijs €
24280109	STPEN175	190	175	21,90
24280208	STPEN300	350	300	32,90

Limit



Steekpasser met vastzetschroef. DIN 6486. Gesmeed staal. Geklonken. Met geharde punten en vierkante benen.

Order nr.	Orig. nr.	Lengte benen mm	Prijs €
24291007	STPSCHR500	500	54,50

Limit



Steekpasser. DIN 6486.
Gesmeed staal. Geklonken. Met
geharde punten en vierkante
benen.

Order nr.	Orig. nr.	Lengte benen mm	Prijs €
24290207	STP150	150	9,60
24290405	STP200	200	10,90
24299010	STP250	250	12,90
24290702	STP300	300	16,90
24290801	STP400	400	39,90
24299020	STP500	500	44,50
24299030	STP600	600	80,90

Limit



Voetjespasser. DIN 6482.
Gesmeed staal. Geklonken. Met
vlakke gepolijste benen.

Order nr.	Orig. nr.	Lengte benen mm	Prijs €
24409010	VP150	150	8,10
24400509	VP200	200	8,70
24409020	VP250	250	11,90
24400707	VP300	300	13,50
24409030	VP600	600	48,50
24409040	VP800	800	80,90
24409050	VP1000	1000	113,00

Limit



Steekpasser met veer. DIN 6487.
Met veer en snelspanschroef.
Gesmeed staal. Geklonken. Met
geharde punten en vierkante
benen.

Order nr.	Orig. nr.	Lengte benen mm	Prijs €
24449010	STP125V	125	9,20
24440406	STP150V	150	13,50
24449020	STP175V	175	13,90
24440505	STP200V	200	15,90
24449030	STP250V	250	16,50
24449040	STP400V	400	24,90
24449050	STP500V	500	28,90
24449060	STP600V	600	31,90

Limit



Voetjespasser met veer. DIN
6487. Gesmeed staal. Met veer
en snelspanschroef. Geklonken.
Met vlakke gepolijste benen.

Order nr.	Orig. nr.	Lengte benen mm	Prijs €
24459010	VP125V	125	9,20
24450405	VP150V	150	13,50
24450504	VP200V	200	15,90
24459020	VP250V	250	14,90
24450702	VP300V	300	23,90
24459030	VP400V	400	22,90
24459040	VP500V	500	26,50
24459050	VP600V	600	31,90

Limit



Krompasser. DIN 6484.
Gesmeed staal. Geklonken. Met
vlakke gepolijste benen.

Order nr.	Orig. nr.	Lengte benen mm	Maximum capaciteit mm	Prijs €
24399010	KRP150	150	-	8,10
24390502	KRP200	200	300	8,70
24399020	KRP250	250	-	12,90
24390700	KRP300	300	348	13,50
24391005	KRP500	500	850	38,50
24399030	KRP600	600	1100	48,50
24391104	KRP800	800	1250	65,50
24399040	KRP1000	1000	-	113,00

Limit



Krompasser met veer. DIN 6487.
Gesmeed staal. Met veer en
snelspanschroef. Geklonken. Met
vlakke gepolijste benen.

Order nr.	Orig. nr.	Lengte benen mm	Prijs €
24430407	KRP150V	150	13,50
24430506	KRP20V	200	15,90
24430704	KRP30V	300	23,90

Limit



Krompasser met veer. DIN 6487.
Gesmeed staal. Met veer en
snelspanschroef. Geklonken. Met
vlakke gepolijste benen.

Order nr.	Orig. nr.	Lengte benen mm	Prijs €
24439005	KRP125VL	125	9,20
24439010	KRP250VL	250	13,90
24439020	KRP40VL	400	24,90
24439030	KRP50VL	500	26,50
24439040	KRP60VL	600	32,50

Limit



Steekpasser met vastzetschroef
DIN 6486. Gesmeed staal.
Geklonken met vastzetschroef.
Met geharde punten en
vierkante benen.

Order nr.	Orig. nr.	Lengte benen mm	Prijs €
122010150	STP150SCH	150	11,90
122010200	STP200SCH	200	13,90
122010250	STP250SCH	250	18,50
122010300	STP300SCH	300	23,90

Kraspennen

Limit



Kraspen. 2-zijdig model.

Order nr.	52530102	52530201	52539010
Orig. nr.	KPDST	KPDHSS	KPDSTBULK
Lengte	mm 240	240	250
Diameter	mm 4	4	4
Type	stalen top	hss top	stalen top
Verpakking	indiv. - pvc zakje	indiv. - pvc zakje	bulk
Prijs	€ 4,80	9,40	3,40

Limit



Kraspen. Hardmetalen punt. K30 kwaliteit.

Order nr.	24750101
Orig. nr.	KPK30
Lengte	mm 130
Verpakking	indiv. - pvc zakje
Prijs	€ 8,40

Limit



Kraspen. Hardmetalen punt. K20 kwaliteit.

Order nr.	24741001
Orig. nr.	KPK20
Lengte	mm 150
Diameter	mm 6
Verpakking	indiv. - pvc zakje
Prijs	€ 3,60

Limit



Kraspen met puntslag. Hardmetalen punt. Wanneer de centerpunt wordt ingedrukt, lost een veer en wordt een indruk geslagen.

Order nr.	102300100
Orig. nr.	KPPU
Lengte	mm 140
Prijs	€ 32,90

Limit



Accessoires voor kraspennen KPPU.

Order nr.	102300209
Orig. nr.	KPPUPT
Accessoire	Vervangpunt 40x3mm
Prijs	€ 9,80

Limit



Kraspen met puntslag. Met handvat. Hardmetalen omkeerbare punt met 2 hardmetalen kanten.

Order nr.	24850109
Orig. nr.	KPREV
Totale lengte	mm 100
Diameter	mm 7
Prijs	€ 25,50

Limit



Accessoire voor kraspennen KPREV.

Order nr.	24850208
Orig. nr.	KPREVPT
Accessoire	Vervangpunt voor kraspen
Prijs	€ 15,90

Limit



Automatische kraspen met vergrendeling. Hardmetalen punt. Met clip.

Order nr.	24821001
Orig. nr.	KPK20150
Lengte	mm 150
Prijs	€ 8,70

Limit



Accessoire kraspennen KPK20150.

Order nr.	24820201
Orig. nr.	KPK20PT
Lengte	mm 20x2
Accessoire	Vervangpunt voor kraspen
Prijs	€ 4,90

TENGI TOOLS



SCR01. Kraspen. Hardmetalen punt. Rond, gekarteld handvat.

Order nr.	173480107
Orig. nr.	SCR01
Lengte	mm 135
Prijs	€ 12,50

Gradenbogen

Limit



Gradenboog. Speciaal staal. Matverchromde schaal. Met stelschroef.

Order nr.	25490103		
Orig. nr.	GBRO		
Lengte been	mm	150	
Gradenboog schijfvormig	mm	rond	
Diameter schijf gradenboog	mm	85	
Prijs	€	24,90	

Limit



Gradenboog. Speciaal staal. Schaalverdeling 0-180°. Matverchromde schaal. Met vaststelschroef.

Order nr.	Orig. nr.	Diameter gradenboog	Lengte been	Prijs
		mm	mm	€
25480104	GB80	80	120	28,50
25480203	GB120	120	150	30,90
25480302	GB150	150	200	40,90
25480401	GB200	200	300	46,50
25489010	GB250	250	500	66,90
25489020	GB300	300	600	100,00

Limit



Gradenboog. Speciaal staal. Met glijdend been. Schaalverdeling 10-170°. Matverchromde schaal. Met stelschroef.

Order nr.	25500109	25500208	25500406	
Orig. nr.	GBO150	GBO200	GBO300	
Diameter gradenboog	mm	150	200	300
Lengte been	mm	300	400	600
Prijs	€	49,50	64,50	118,00

Limit



Precisiegradenboog. Roestvrij staal. Met roterende schaal voor snelaflezing en naald voor fijnaflezing. Verschuifbare lineaal en 360° draaibare hoekaanslag.

Order nr.	119190106	
Orig. nr.	GBH300	
Lengte meetlat	mm	300
Bereik per toer van de naald	mm	10
Prijs	€	117,00

Limit



Precisiegradenboog. Roestvrij staal. Met roterende schaal voor snelaflezing en naald voor fijnaflezing met vergrootglas voor lezing. Verschuifbare lineaal en 360° draaibare hoekaanslag nonius 1/12° = 5 min.

Order nr.	122580103	
Orig. nr.	GBEC1/12	
Lengte meetlat	mm	150-300
Prijs	€	103,00

Limit



Digitale gradenboog. Roestvrij staal. Mogelijk lezingen: 0-360°, 0-180° of 0-90°. Kan gebruikt worden in alle posities. Vastzetten van de gemeten waarden. 2 meetlatten 150 en 300mm. Vastzethoek 90°. Geleverd zonder batterijen (batterij 1x CR2032).

Order nr.	151270105	
Orig. nr.	GBDIG	
Schaalverdeling	°	0-360, 0-180 of 0-90
Resolutie	°	0,1
Nauwkeurigheid	°	+/- 0,2
Lengte meetlat	mm	150 - 300
Prijs	€	484,00

Limit



Digitale gradenboog met waterpas op bovenkant. Kan in alle posities gebruikt worden. Vastzetten van de gemeten waarden met vastzetgroef. Geleverd zonder batterijen (batterij 1x CR2032).

Order nr.	166580100	
Orig. nr.	DG250	
Schaalverdeling	°	0-360
Resolutie	°	0,1
Nauwkeurigheid	°	+/- 0,25
Lengte	mm	250
Hoogte display	mm	13
Prijs	€	84,50

TOOLS



Digitale precisie waterpas en gradenboog.

Kenmerken:

- Aflezing 0-90°
- Alternatieve hoek 0-100%
- Magnetisch met V-groef
- Kan in alle posities gebruikt worden
- Vastzetten van de gemeten waarden
- Display draait wanneer pas met 180° gedraaid wordt
- Verlichte display
- Met automatische uitschakelling na 3 minuten

Geleverd zonder batterijen.

Order nr.	174260109
Orig. nr.	DW150
Graden	4x90°
lezingshoek	0-100%
Resolutie	mm 0,1°
Nauwkeurigheid	+/- 0,3°
Batterijen	1x3V CR2032
Afmetingen	mm 150x50x33
Prijs	€ 119,00



Mini digitale waterpas en gradenboog. De display duidt twee waarden aan: een absolute waarde en een relatieve waarde. Gekantelde display voor een duidelijke aflezing. Nulstelling in elke positie. Magneet op de basis voor bevestiging op zaagblad, stalen frame, enz. Schakelt automatisch uit na 3 minuten. 2 batterijen AAA 1,5V niet meegeleverd.

Order nr.	174250209
Orig. nr.	WPD10
Bereik	° 0 - 180
Minimum aflezing	° 0,1
Nauwkeurigheid	° +/- 0,3
Stof- en waterdicht	IP 54
Prijs	€ 83,90

Hoogtemeters



Hoogtemeter in werkplaatstaal. DIN 862. Met fijnafstelling en vastzetschroef. Gehard en geslepen. Matverchroomde schaal en nonius. Nonius 0,05mm. Geleverd in een houten opbergdoos.

Order nr.	22490056	22490106	22490205
Orig. nr.	HM300	HM500	HM1000
Afmetingen basis	mm 110x60	150x90	220x150
Hoogte kraspen	mm 300	500	1000
Prijs	€ 112,00	171,00	645,00



Digitale hoogtemeter in roestvrij staal. DIN 862. Instelbare meetrichting. Gehard en geslepen. On/off switch. Aflezing 0,01mm. 0,0005. Mm/inch omstelbaar. Connectie met PC mogelijk. Geleverd in een houten opbergdoos, zonder batterijen (batterij 1x CR2032).

Order nr.	21461108	21461306
Orig. nr.	HMD300	HMD500
Meetbereik	mm 300	500
Nauwkeurigheid	mm +/- 0,03	+/- 0,03
Prijs	€ 340,00	509,00



Accessoires voor hoogtemeters HM.

Order nr.	22490304	22490403
Orig. nr.	HMKR300	HMKR500100
Accessoire	extra kraspunt voor 22490056	extra kraspunt voor 22490106 en 22490205
Prijs	€ 18,50	22,90



Accessoires voor digitale hoogtemeters HMD.

Order nr.	21461207	21461405
Orig. nr.	HMK300	HMK500
Accessoire	Extra kraspunt voor 21461108	Extra kraspunt voor 21461306
Prijs	€ 29,90	41,90

Krasblokken

Limit



Krasblok. Met ronde gietijzeren voet. Stalen punt. Zonder fijnafstelling.

Order nr.	52380102 ^M	
Orig. nr.	SG38	
Hoogte as	mm	300
Prijs	€	36,90

Limit



Krasblok. Met prisma-vormige gietijzeren voet. Stalen punt. Met verstelbare stang.

Order nr.	52430105 ^M	
Orig. nr.	SG43	
Hoogte as	mm	300
Prijs	€	63,50

Meetstandaarden

Limit



Meetstandaard. Magnetische kracht kan aan- of uitgeschakeld worden. Basisplaat in V vorm. Opname 6-8mm.

Order nr.	151280104 ^M	
Orig. nr.	MB40	
Maximum instelbare hoogte	mm	230
Afmetingen basis	mm	30x35x36
Diameter montageopening	mm	6-8
Magnetische kracht	kg	40
Netto gewicht	kg	2
Prijs	€	50,50

Limit



Spanninghouder voor meetklok.

Order nr.	151290103 ^M	151290202 ^M
Orig. nr.	DHOUNIV	FUFLOHOUNIV
Diameter opening/niveau type	mm	8 en 6
Afmetingen houder arm	mm	6 x 12 diam. 8
Lengte	mm	100
Klemming		zwaluwstaart kogelgewricht
Prijs	€	19,50

Limit



Meetstandaard op magnetische basis. Met on/off switch op de basis. V-vormige geslepen basis.

Order nr.	60191004 ^M	
Orig. nr.	LIMS	
Maximum instelbare hoogte	mm	250
Afmetingen basis	mm	50x55x58
Diameter montageopening	mm	8
Magnetische kracht	kg	75
Netto gewicht	kg	1,5
Prijs	€	34,90

Limit



Magnetische basis voor meetstandaard 60191004. Magnetische kracht 100 kg.

Order nr.	60190600 ^M	
Orig. nr.	MBS100	
Magnetische kracht	kg	100
Prijs	€	40,90

Limit



Meetstandaard op magnetische basis.

- Extra-zware uitvoering.
- Opname 8mm.
- Met on/off switch op de basis.
- V-vormige geslepen basis.

Order nr.	119080208 ^M	119080257 ^M
Orig. nr.	MAGMSKL	MAGMSKLF
Maximum instelbare hoogte	mm	330
Afmetingen basis	mm	50x55x58
Diameter montageopening	mm	8
Magnetische kracht	kg	80
Netto gewicht	kg	1,9
Fijnafstelling		✓
Prijs	€	74,50

Limit



Meetstandaard 119080208 met meetklok 119110104.

Order nr.	119081008 M		
Orig. nr.	MAGMSD		
Maximum instelbare hoogte	mm	330	
Afmetingen basis	mm	58x50x55	
Diameter montageopening	mm	8	
Magnetische kracht	kg	80	
Netto gewicht	kg	1,9	
Meetbereik	mm	10	
Schaalverdeling		0-100 - 100-0	
Bereik per toer van de naald	mm	1	
Diameter klok	mm	58	
Prijs	€	101,00	

Meetstokken

Limit



Telescopische meetstokken
6-delige. Twee verende
en geharde meetpunten.
Vergrendeling aan bovenkant
van de schacht. Lezing gebeurt
door een micrometer of
schuifmaat.

Order nr.	52910106 M		
Orig. nr.	MSTST		
Meetbereik	mm	8-150	
Prijs	€	40,50	

Limit



Afzonderlijke meetstokken uit set
52910106

Order nr.	Orig. nr.	Meetbereik mm	Prijs €
52910205 M	MST127	8-12,7	8,80
52910304 M	MST19	12,7-19	8,80
52910403 M	MST34	19-32	8,80
52910502 M	MST54	32-54	8,80
52910601 M	MST90	54-90	8,80
52910700 M	MST150	90-150	14,90

Waterpassen

TENGTTOOLS



SLA040. Waterpas in aluminium. Nauwkeurigheid 1.0 mm/m.

Order nr.	173260100 T		
Orig. nr.	SLA040		
Lengte	mm	400	
Prijs	€	11,60	

Limit



0749



12187

Machine precisiewaterpas. Gemaakt uit hoogwaardig gietijzer
staal. Met prisma-basis. Met verticaal en horizontaal waterpas.
DIN 877.

Order nr.	Orig. nr.	Lengte mm	Schaalver- deling mm/m	Nauwkeu- righeid mm	Prijs €
07490055 M	WP100	100	0,05	0,025	163,00
07490154 M	WP150	150	0,05	0,025	160,00
07490204 M	WP2001	200	0,10	0,025	176,00
07490402 M	WP20002	200	0,02	0,005	176,00
121870300 M	WP300	300	0,02	0,02	276,00

Limit



Raamwaterpas. Gietijzer. Nauwkeurig
geslepen. Groef V-geslepen. Instelbare
hellingmeter. DIN 877.

Order nr.	Orig. nr.	Lengte mm	Hoogte mm	Schaalver- deling mm/m	Nauwkeu- righeid mm/m	Prijs €
07570039 M	RWP100	100	100	0,05	0,025	234,00
07570054 M	RWP150	150	150	0,05	0,025	234,00
07570104 M	RWP2001	200	200	0,10	0,025	234,00
07570203 T	07570203	200	200	0,02	0,005	320,00

Limit



Digitale precisie waterpas en gradenboog.

Kenmerken:

- Aflezing 0-90°
- Alternative hoek 0-100%
- Magnetisch met V-groef
- Kan in alle posities gebruikt worden
- Vastzetten van de gemeten waarden
- Display draait wanneer pas met 180° gedraaid wordt
- Verlichte display
- Met automatische uitschakeling na 3 minuten

Geleverd zonder batterijen.

Order nr.	174260109
Orig. nr.	DW150
Graden	4x90°
Lezingshoek	0-100%
Resolutie	mm 0,1°
Nauwkeurigheid	+/- 0,3°
Batterijen	1x3V CR2032
Afmetingen	mm 150x50x33
Prijs	€ 119,00

Limit



Mini digitale waterpas en gradenboog. De display duidt twee waarden aan: een absolute waarde en een relatieve waarde. Gekantelde display voor een duidelijke aflezing. Nulstelling in elke positie. Magneet op de basis voor bevestiging op zaagblad, stalen frame, enz. Schakelt automatisch uit na 3 minuten. 2 batterijen AAA 1,5V niet meegeleverd.

Order nr.	174250209
Orig. nr.	WPD10
Bereik	° 0 - 180
Minimum aflezing	° 0,1
Nauwkeurigheid	° +/- 0,3
Stof-en waterdicht	IP 54
Prijs	€ 83,90

Limit



Digitale waterpas en gradenboog.

Kenmerken:

- Magneet aan de basis voor montage op zaagblad, stalen frame, enz.
- Zero instelling in elke positie.
- Automatisch uit na 3 minuten.
- Geleverd met batterij.

Order nr.	174250050
Orig. nr.	WPD05
Bereik	° 4 x 0 - 90
Minimum aflezing	° 0,1
Nauwkeurigheid	° + 0,3
Prijs	€ 41,90

TENGTTOOLS

MAGNETISCH

BOUW



NEW

Torpedo waterpas uit aluminium.

Kenmerken:

- Schokbestendig
- Met 3 metalen magneten aan de onderkant
- Transparante en duurzame buisvormige libellen
- Hoge weerstand tegen ultraviolet licht en temperatuurschommelingen
- De luchtbel wordt niet beïnvloed door statische elektriciteit

Order nr.	237930102
Orig. nr.	SLT01
Nauwkeurigheid	mm/m +/- 1
Afmetingen (l x b x h)	mm 230 x 16 x 38
Prijs	€ 20,40

TENGTTOOLS

MAGNETISCH

BOUW



NEW

Torpedo waterpas uit ABS kunststof.

Kenmerken:

- Schokbestendig
- Met magneten aan de onderkant
- Transparante en duurzame buisvormige libellen
- Hoge weerstand tegen ultraviolet licht en temperatuurschommelingen
- De luchtbel wordt niet beïnvloed door statische elektriciteit

Order nr.	237930201
Orig. nr.	SLT02
Nauwkeurigheid	mm/m +/- 1,5
Afmetingen (l x b x h)	mm 230 x 16 x 40
Prijs	€ 8,80

TENGTTOOLS



BOUW

Waterpas uit aluminium.

Kenmerken:

- Gemakkelijk vast te houden profiel 24 x 50 mm
- Transparante en duurzame buisvormige libellen
- Hoge weerstand tegen ultraviolet licht en temperatuurschommelingen
- De luchtbel wordt niet beïnvloed door statische elektriciteit
- Schokabsorberende uiteinden
- Weerstand van de libellenhouders tegen hoge temperaturen
- Beschikbaar in volgende lengtes: 300,400,600,1000,1200,1800,2000 mm

Order nr.	Orig. nr.	Nauwkeurigheid	Nauwkeurigheid ondersteboven	Prijs
		mm/m	mm/m	€
237980107	SLA0300	+/- 1,5	+/- 0,75	15,00
237980206	SLA0400	+/- 0,5	+/- 0,75	16,90
237980305	SLA0600	+/- 0,5	+/- 0,75	18,80
237980404	SLA1200	+/- 0,5	+/- 0,75	34,90
237980503	SLA1500	+/- 0,5	+/- 0,75	41,10
237980602	SLA1800	+/- 0,5	+/- 0,75	46,00
237980701	SLA2000	+/- 0,5	+/- 0,75	48,10

TENGTOLS



BOUW

HEAVY DUTY NEW

Waterpas uit aluminium.

Kenmerken:

- Stevig frame uit geëxtrudeerd aluminium, 26 x 58 mm
- Transparante en duurzame buisvormige libellen
- Hoge weerstand tegen ultraviolet licht en temperatuurschommelingen
- De luchtbel wordt niet beïnvloed door statische elektriciteit
- Schokabsorberende uiteinden
- Weerstand van de libellenhouders tegen hoge temperaturen
- Beschikbaar in volgende maten: 400, 600, 800, 1000, 1200, 1500, 1800, 2000 mm

Order nr.	Orig. nr.	Nauwkeurigheid	Nauwkeurigheid ondersteboven	Prijs
		mm/m	mm/m	€
237990106	SLC0400	+/- 0,5	+/- 0,75	31,80
237990205	SLC0600	+/- 0,5	+/- 0,75	39,50
237990304	SLC0800	+/- 0,5	+/- 0,75	43,90
237990403	SLC1000	+/- 0,5	+/- 0,75	54,60
237990502	SLC1200	+/- 0,5	+/- 0,75	66,70
237990601	SLC1500	+/- 0,5	+/- 0,75	80,70
237990700	SLC1800	+/- 0,5	+/- 0,75	86,90
237990809	SLC2000	+/- 0,5	+/- 0,75	94,70

TENGTOLS



BOUW

MAGNETISCH NEW

Waterpas uit aluminium.

Kenmerken:

- Gemakkelijk vast te houden profiel 24 x 50 mm, met magneten aan de onderkant
- Transparante en duurzame buisvormige libellen
- Hoge weerstand tegen ultraviolet licht en temperatuurschommelingen
- De luchtbel wordt niet beïnvloed door statische elektriciteit
- Schokabsorberende uiteinden
- Weerstand van de libellenhouders tegen hoge temperaturen
- Beschikbaar in volgende maten: 300, 400, 600, 1000, 1200mm

Order nr.	Orig. nr.	Nauwkeurigheid	Nauwkeurigheid ondersteboven	Prijs
		mm/m	mm/m	€
238000103	SLM0300	+/- 0,75	+/- 0,75	48,90
238000202	SLM0400	+/- 0,75	+/- 0,75	50,20
238000301	SLM0600	+/- 0,75	+/- 0,75	57,00
238000400	SLM1200	+/- 0,75	+/- 0,75	88,30

V-blokken

Limit



Set van 2 V-blokken. Werkplaatskwaliteit. Geslepen. Per paar. Uniformiteit en parallelisme +/- 0,03mm. Hoek V-groef: 90°.

Order nr.	Orig. nr.	Breedte	Hoogte	Dikte	Breedte V-groef	Diepte V-groef	Prijs
		mm	mm	mm	mm	mm	€
25020108	VBL7503	75	60	32	44	23	51,50
25020207	VBL10003	100	65	41	50	28	66,50
25020405	VBL15003	150	90	63	82	39	141,00
25020603	VBL20003	205	140	100	100	56	321,00

Limit



Set van 2 V-blokken. Uit speciaal staal. Geslepen, bewerkt en genummerd per paar. ingangshoek 90°. Uniformiteit en parallelisme +/- 0,008mm.

Order nr.	Orig. nr.	Langte	Afmetingen vierkant	Diameter V-groef	Prijs
		mm	mm	mm	€
121700075	VBL75008	75	40	5-40	116,00
121700100	VBL100008	100	45	6-45	146,00
121700150	VBL150008	150	55	8-55	239,00

Limit



Set van 2 V-blokken. Met 2 spanbeugels. Uit speciaal staal. Geslepen, bewerkt en genummerd per paar. 2 ingangshoeken 90°. Uniformiteit en parallelisme +/- 0,01mm.

Order nr.	Orig. nr.	Maximum diameter klemmen	Prijs
		mm	€
52520202	VBL2501	25	55,50
52520301	VBL3501	37	59,90
52520400	VBL7501	40	160,00

Limit



Set van 2 V-blokken. Met 2 spanbeugels. Uit speciaal staal. Geslepen, bewerkt en genummerd per paar. 2 ingangshoeken 90°. Uniformiteit en parallelisme +/- 0,008mm. Din 876/0

Order nr.	Orig. nr.	Voor assen diameter	Prijs
		mm	€
121800045	VBL45008	5-20	116,00
121800070	VBL7025008	5-25	148,00
121800071	VBL7032008	5-32	222,00
121800125	VBL125008	5-45	298,00

Vlaktafels

MIB



Gietijzeren vlaktafel. Stabiele constructie. Conform DIN 876/1.

Order nr.	Orig. nr.	Gewicht kg	Afmetingen (l x b x h) mm	Prijs €
190170409	VP400600/1	42,00	600 x 400 x 65	478,00
25959100	VP200200/1	9,00	200 x 200 x 60	153,00
25959102	VP400400/1	30,00	400 x 400 x 60	302,00
25959103	VP500400/1	31,00	500 x 400 x 65	403,00
25959104	VP500500/1	37,00	500 x 500 x 65	425,00
25959105	VP500600/1	52,00	600 x 500 x 90	505,00
25959106	VP600800/1	95,00	80 x 600 x 100	1.069,00

Kalibers

Limir



Laskaliber. Met 12 bladen.

Order nr.	74031006
Orig. nr.	LKA314
Schaalverdeling	mm 3-12
Prijs	€ 26,50

Limir



Laskaliber voor het meten in hoeken, verpakt in plastic doos.

Order nr.	97541007
Orig. nr.	LKA60DEGR
Lasnaad	mm 0-10
Hoogte	mm 0-10
Hoeken	° 70-90-150
Lengte	mm 45
Prijs	€ 47,90

Limir

NEW



Digitale laskaliber 20 mm. Geschikt voor het meten van lasnaden in hoeken en de hoogte van platte naden. MM/inch. Schakelt automatisch uit. Batterij 1,5V type SR44.

Order nr.	233820109
Orig. nr.	LKA60DI
Lasnaad	mm 20
Hoogte	mm 10
Nauwkeurigheid	mm + 0,03
Resolutie	mm 0,01
Hoogte letters	mm 8
Prijs	€ 109,00

Limir



Laskaliber. 60°-70°-80°-90°. Nauwkeurigheid 1/10mm.

Order nr.	25690108
Orig. nr.	LKA90DEGR
Schaalverdeling	mm 20
Prijs	€ 31,90

Limir



Kaliber voor boren. Wordt gebruikt bij slijpen van boren ter controle van de slijphoek. Gegradueerd tot 25 mm. Voor boren tot 50mm.

Order nr.	25650102
Orig. nr.	GRIGA25
Snijhoek	118°
Prijs	€ 5,70

OPTIMUM



Parallel onderlegplaatset 20dlg.

Kenmerken:

- Voor het parallel opnemen van werkstukken in machineklemmen, opspanplaten, werktuigmachines, dit om een preciezere bewerking te bekomen.
- Fijn geslepen op 0,01 mm nauwkeurig

Inhoud 20 dlg:

- 2 x 13 x 3 x 150 mm
- 2 x 16 x 3 x 150 mm
- 2 x 19 x 3 x 150 mm
- 2 x 22 x 3 x 150 mm
- 2 x 28 x 3 x 150 mm
- 2 x 31 x 3 x 150 mm
- 2 x 35 x 3 x 150 mm
- 2 x 38 x 3 x 150 mm
- 2 x 41 x 3 x 150 mm

- In een praktische kunststofkoffer.

Order nr.	713354001
Orig. nr.	POP20
Stuks	20
Kalibers	van 13x3x150 tot 41x3x150
Prijs	€ 150,00

TOOLS



Eindmatenset (kaliber-set). Speciaal gehard staal. Geslepen en handgepolijst. Geleverd in houten doos. Nauwkeurigheid DIN 861/1 of DIN861/2.

Order nr.	52720109	52720307	52720208	52720406
Orig. nr.	CA47DIN2	CA47DIN1	CA87DIN2	CA87DIN1
Aantal blokken	47	47	87	87
Capaciteit	mm	mm	mm	mm
Tolerantie	DIN 861/2	DIN 861/1	DIN 861/2	DIN 861/1
Gewicht	kg	kg	kg	kg
Afmetingen (l x b x h)	mm	mm	mm	mm
Prijs	€	€	€	€



Stalen schroefdraadmeter. Voor Withworth schroefdraad 55° of metrische schroefdraad 60°.

Order nr.	26390300	26390301
Orig. nr.	DKA	DKB
Voor	Withworth schroefdraad 55°	Metrische schroefdraad 60°
Prijs	€	€



Diameter kaliber. Voor het meten en controleren van buizen en kleine gaatjes.

Order nr.	26390104
Orig. nr.	DIK15
Diameter	mm
Aantal pinnen	20
Prijs	€

Maatlatten



Maatlat. Gehard roestvrij veerstaal. Extra dun. Schaalverdeling in mm. Met montageopening.

Order nr.	Orig. nr.	Lengte mm	Prijs €
27020106	MLF100	100	6,90
27020205	MLF150	150	6,90
27020304	MLF200	200	7,10
27020403	MLF300	300	7,60
27020502	MLF500	500	14,90
27020601	MLF1000	1000	32,90



Maatlat. Gehard roestvrij veerstaal. Zeer leesbare matverchroomde schaal. Schaalverdeling in mm en 1/2mm. Tot 500mm: dubbelzijdige schaal. Met montageopening. EG Din 1L - Din 2768 M.

Order nr.	Orig. nr.	Lengte mm	Prijs €
121900100	LFL100	100	4,60
121900150	LFL150	150	3,50
121900200	LFL200	200	4,10
121900250	LFL250	250	4,60
121900300	LFL300	300	4,60
121900500	LFL500	500	9,10
121901000	LFL1000	1000	30,90
121902000	LFL2000	2000	52,50



Maatlat. Gehard roestvrij veerstaal. Zeer leesbare matverchroomde schaal. Schaalverdeling in mm en inch. Met montageopening.

Order nr.	Orig. nr.	Lengte mm	Prijs €
27030055	MLFB150	150	9,80
27030105	MLFB300	300	15,90
27030204	MLFB500	500	31,90
27030303	MLFB1000	1000	61,50



Maatlat. Gehard roestvrij veerstaal. Zeer leesbare matverchroomde schaal. Schaalverdeling in mm aan de bovenkant en in 1/2mm aan de onderkant. Met montageopening.

Order nr.	Orig. nr.	Lengte mm	Nauwkeurigheid mm	Prijs €
84270107	MLFF150	150	0,12	8,70
84270206	MLFF300	300	0,13	14,90
84270305	MLFF600	600	0,16	34,90
84270404	MLFF1000	1000	0,20	70,90
84270503	MLFF2000	2000	0,30	444,00
84270602	MLFF300A	3000	0,40	909,00



Maatlat. Gehard roestvrij veerstaal. EG DIN II - DIN 7168
M. Matverchroomde schaal. Schaalverdeling in 1/2 mm.
Dubbelzijdige schaalverdeling. Met montageopening.

Order nr.	Orig. nr.	Lengte mm	Omschrijving	Prijs €
121920500	LFLD500	500	alu	13,90
121923000	MIBLAFD3000	3000	inox	194,00
121925000	LFLD5000	5000	inox	298,00



Maatlat. EG DIN II - DIN 7168 M. Matverchroomde schaal.
Schaalverdeling in mm 1/2mm en inch (1/32, 1/64, 1/16). Met montageopening. Tot 500mm: dubbelzijdige schaalverdeling.

Order nr.	121930300	121930500
Orig. nr.	LFLE300	LFLE500
Lengte mm	300	500
Prijs €	10,50	21,50



Precisie maatlat met afgeschuinde rand. Schaalverdeling in mm.

Order nr.	27050608
Orig. nr.	MLP1500
Lengte mm	1500
Prijs €	271,00



Flexibele omtrekmeter conform DIN 7168 m. Maat 16 x 0,2mm.
Met nonius Voor het meten van omtrek en diameter. Schaal in mm. Aflezing in 0,1mm. Uitvoering in inox.

Order nr.	Orig. nr.	Voor omtrek-meting mm	Voor diameter-meting mm	Prijs €
121941519	OMTR1500	60-5980	20-1900	209,00
121952030	OMTR20	60-950	20-300	98,50
121953070	OMTR3100	60-2200	20-700	130,00
121957011	OMTR700	60-3780	20-1200	157,00
121951115	OMTR1100	60-4720	20-1500	187,00
121951519	OMTR1500S	60-5980	20-1900	218,00
121951923	OMTR1900	60-7540	20-2400	263,00
121952327	OMTR2300	60-8500	20-2700	281,00
121952731	OMTR2700	60-9760	20-3100	314,00
121953135	LIOM3100	60-11310	20-3600	345,00



Aluminium duimstok. Gradueerd op beide kanten in mm schaal.
Samenplooibaar op 20cm. EG CLASS III.

Order nr.	105900205	105900306
Orig. nr.	DSA1M	DSA2M
Lengte mm	1000	2000
Opdeling mm	5x200	10x200
Prijs €	11,90	19,90



Houten duimstok. Geel gelakt. Gegradeerd op beide kanten in mm-schaal. Samenplooibaar op 20cm. EG CLASS III.

Order nr.	105900407
Orig. nr.	FOLDWOOD
Lengte mm	2000
Opdeling mm	10x200
Prijs €	4,60



Meetlat. Getrokken staal. DIN 874/2 (25070) of DIN874/1 (25071-2). Rechthoekig profiel. Fijn gepolierd en gekalibreerd. (Vanaf 2500mm met I-profiel en 2 handgrepen).

Order nr.	Orig. nr.	Lengte mm	Prijs €
25070103	ML12500	500	142,00
25070202	ML121000	1000	235,00
25070301	ML121500	1500	405,00
25070400	ML122000	2000	535,00
25070509	ML122500	2500	855,00
25070608	ML12300	3000	1.279,00
25070707	ML1240	4000	2.879,00
25071507	ML11500	500	191,00
25071606	ML111000	1000	355,00
25071705	ML111500	1500	589,00
25071804	ML112000	2000	1.389,00
25071903	ML112500	2500	1.545,00
25072000	ML11300	3000	2.135,00
25072109	ML1140	4000	4.039,00

Limit



Meetlat. Werkplaatskwaliteit. Gepolierd. Zonder maatverdeling. Rechthoekig profiel. DIN 874/00. Zwarte 30° meethoek. Geleverd in een houten koffer.

Order nr.	Orig. nr.	Lengte mm	Prijs €
52090107	MLA75	75	23,50
52090206	MLA100	100	26,90
52090305	MLA200	200	39,50
52090404	MLA300	300	73,90

Limit



Meetlat. Werkplaatskwaliteit. Gepolierd. Zonder maatverdeling.

Order nr.	Orig. nr.	Lengte mm	Prijs €
25069010	ML3004	300	13,90
25069020	ML400	400	18,50
25060104	ML500	500	21,50
25069030	ML600	600	26,90
25069040	ML800	800	31,90
25060302	ML1000	1000	39,90
25060500	ML1500	1500	71,90
25060609	ML2000	2000	89,90
25060807	ML300	3000	285,00

Limit



Meetlat. Werkplaatskwaliteit. Gepolierd. Profiel met afgeschuinde hoek. Zonder maatverdeling.

Order nr.	Orig. nr.	Lengte mm	Prijs €
25059000	MLS300	300	18,50
25059011	MLS400	400	21,50
25050204	MLS500	500	26,50
25059012	MLS600	600	31,90
25059013	MLS800	800	39,90
25050501	MLS1000	1000	46,50
25050600	MLS1500	1500	83,90
25050709	MLS2000	2000	136,00
25059015	MLS3005	3000	299,00

MIB



Meetlat. Werkplaatsstaal. Gepolierd. Met mm-maatverdeling. Profiel met afgeschuinde hoek.

Order nr.	Orig. nr.	Prijs €
27109010	PML500	35,90
27109011	PML800	59,50
27109012	PML1000	65,90
27109013	PML1500	108,00
27109014	PML2000	148,00
27109015	PML300	255,00

Limit



Zelfklevende meetlint. Wit gelakt staal. Schaalverdeling in mm boven- en onderaan. cm (zwart) en dm (rood) aanduiding. Ook voor verticale paneelzaagmachines.

Order nr.	Orig. nr.	Lengte mm	Omschrijving	Voor type	Prijs €
801200802	MLZ1000	1000	links naar rechts	PPRO, C4,	13,50
801200803	MLZ2000	2000	links naar rechts	C5, H5, H6, P5, P6	23,90
801200813	MLZ2000A	2000	rechts naar links		24,90
801200804	MLZ300		rechts naar links	H7, P7	31,90
801200805	MLZ5000	5000	links naar rechts		50,50
801200814	MLZ5000B	5000	rechts naar links		51,50

TENGTOLS



NEW

Professionele rolmeter. Stevige kunststof behuizing met platte onderkant voor binnenmeting. Met stevige terugkeerveer en sluiting voor het vastzetten van de rolmeter. Gegradueerd op 1 zijde in mm. Gereguleerde versie Klasse II. Leverbaar in lengtes van 3, 5 of 8m.

Order nr.	131920100	131920209	131920308
Orig. nr.	MT03MM	MT05MM	MT08MM
Lengte	m 3	5	8
Breedte	mm 13	19	25
Prijs	€ 5,80	8,70	16,90

TENGTOLS



NEW

Rolmeter.

- Met mm en inch aanduiding
- Schokbestendige pvc behuizing met rubberen grip
- Eindhaak op nul voor binnen en buiten metingen
- Rol met stalen behuizing, om te vermijden dat deze bij het terugtrekken afgesneden wordt
- Nylon lint
- Riemclip
- EEG klasse II

Order nr.	231470105	231470204	231470303
Orig. nr.	MT10	MT15	MT30
Lengte	m 10	15	30
Breedte	mm 10	10	10
Prijs	€ 21,90	23,90	28,50

TENGTOLS



NEW

Rolmeter.

- Met mm en inch aanduiding
- Schokbestendige pvc behuizing met rubberen handvat
- Eindhaak op nul voor binnen en buiten metingen
- Rol met stalen behuizing, om te vermijden dat deze bij het terugtrekken afgesneden wordt
- Nylon lint
- Riemclip
- EEG klasse II

Order nr.	231470402	231470501
Orig. nr.	MTS30	MTS50
Lengte	m 30	50
Breedte	mm 12,7	12,7
Prijs	€ 40,50	60,90

Voelermaten

Limit



Hoekvoelermaten. Voor het meten van diverse hoeken.

Order nr.	25861006
Orig. nr.	ANGGA45
Aantal bladen	18
Voor hoeken	◦ 1 - 2 - 3 - 4 - 5 - 6 - 7 - 8 - 9 - 10 - 12 - 14 - 16 - 18 - 20 - 25 - 30 - 40 - 45
Prijs	€ 40,90

Limit



Voelermaat voor boren en tappen. Intervallen met een stap van 0,1 mm. Aantal gaten 100.

Order nr.	25900309
Orig. nr.	DRIGA10
Diameter	mm 0,1 - 10
Intervallen	mm 0,1
Aantal gaten	100
Dikte	mm 2
Prijs	€ 266,00

TENGTOLS



Voelermaat. Gehard en gewalst staal. Lengte 75mm. 20 stalen bladen.

Order nr.	116860107
Orig. nr.	FG21
Aantal bladen	21
Meetbereik	mm 0,05 - 1,00
Niet-magnetisch brons-blad	mm 0,10
Prijs	€ 16,50

Limit



Voelermaat. Gehard en gewalst staal. Breedte 10mm. 6 bladen. Speciaal model voor het afregelen van motorkleppe.

Order nr.	25959015
Orig. nr.	FG75
Aantal bladen	6
Meetbereik	mm 0,10 - 0,40
Lengte bladen	mm 75
Prijs	€ 3,30



Voelermaat. Gehard en gewalst staal. Breedte 12,7mm.

Order nr.	25971003		
Orig. nr.	FG300		
Aantal bladen	13		
Meetbereik	mm	0,05-1,00	
Lengte bladen	mm	300	
Prijs	€	18,50	



Voelermaat. Gecalibreerd DIN 2275. Gehard en gewalst staal. Met ingesloten certificaat. Gecalibreerd op 2 meetpunten per blad.

Order nr.	25952003	25952102	25952201
Orig. nr.	FGCAL81	FGCAL131	FG100201C
Aantal bladen	8	13	20
Meetbereik	mm	0,03 - 0,10 0,05 - 1,00 0,05 - 1,00	
Bladlengte	mm	100 100 100	
Prijs	€	50,50	81,90 125,00



Voelermaat. Messing. Breedte 12,7mm.

Order nr.	67921106	67921205	
Orig. nr.	FGM131	FGM201	
Aantal bladen	13	20	
Schaalverdeling	mm	0,05 - 1,00 0,05 - 1,00	
Bladlengte	mm	100 100	
Prijs	€	18,50	27,90



Houder voor voelerstrips type 2599. Lengte 135mm. Breedte 13mm.

Order nr.	26000109		
Orig. nr.	FEESTRIHO		
Prijs	€	9,60	



Voelerstrips. Koudgewalste, geharde en witgepolierde stalen band. Afmeting gemarkeerd elke 150mm. Lengte 3m. Breedte 13mm.

Order nr.	Orig. nr.	Bladdikte mm	Tolerantie mm	Prijs €
25990102	VB02	0,02	+/- 0,004	23,50
25990201	VB03	0,03	+/- 0,004	16,90
25990300	VB04	0,04	+/- 0,004	16,90
25990409	VB05	0,05	+/- 0,004	13,50
25990508	VB06	0,06	+/- 0,004	12,50
25990607	VB07	0,07	+/- 0,004	12,50
25990706	VB08	0,08	+/- 0,004	11,50
25990805	VB09	0,09	+/- 0,004	11,50
25990904	VB10	0,10	+/- 0,005	11,50
25991308	VB15	0,15	+/- 0,005	11,50
25991506	VB20	0,20	+/- 0,007	11,50
25991605	VB25	0,25	+/- 0,008	11,50
25991704	VB30	0,30	+/- 0,009	11,50
25991902	VB35	0,35	+/- 0,009	14,90
25992009	VB40	0,40	+/- 0,011	14,90
25992108	VB45	0,45	+/- 0,011	15,90
25992207	VB50	0,50	+/- 0,013	18,50
25992405	VB60	0,60	+/- 0,015	18,50
25992504	VB70	0,70	+/- 0,015	21,90
25992702	VB80	0,80	+/- 0,017	23,90
25992801	VB90	0,90	+/- 0,017	28,90
25992900	FEESTRI1	1,00	+/- 0,017	28,90



Vlakte voelermaat. Wordt gebruikt bij het visueel vaststellen van ruwe oppervlaktes of het voelen met de vingertop. 6 verschillende bewerkingsmethodes, elk met 6 Ra waarden.

Order nr.	53700100		
Orig. nr.	SURFGAU		
Polieren, ruimen, vlakschuren	Ra	1,6 - 0,8 - 0,4 - 0,2 - 0,1 - 0,005	
Horizontaal frezen, vlakdraaien, langsdraaien	Ra	12,5 - 6,3 - 3,2 - 1,6 - 0,8 - 0,4	
Prijs	€	261,00	



Voelermaat. Gehard en gewalst staal. Breedte 12,7mm.

Order nr.	Orig. nr.	Aantal bladen	Meetbereik	Lengte bladen	Prijs €
			mm	mm	
25953001	FG10081	8	0,03 - 0,10	100	4,20
25953100	FG10085	8	0,05 - 0,50	100	4,50
25953209	FG100215	21	0,10 - 0,50	100	9,60
25953308	FG100131	13	0,05 - 1,00	100	4,80
25959014	FG100261	26	0,03 - 1,00	100	11,90
25953407	FG100201	20	0,05 - 1,00	100	8,40
25950601	FG10010	20	0,10 - 2,00	100	28,50
25953506	FG200131	13	0,05 - 1,00	200	13,50
25953605	FG200201	20	0,05 - 1,00	200	19,50
25951104	FG200202	20	0,10 - 2,00	200	50,90

Draadsnijmeters



Draadsnijmeter. Voor het meten van de hoekinstelling. Gehard. Voor engelse en metrische draad.

Order nr.	25751009	25751108
Orig. nr.	THRE55W	THRE60WUN
Schaalverdeling	55°	60°
Type draad	W	W+UN
Prijs	€ 5,50	5,50



Universele draadsnijmeter

Order nr.	25771007
Orig. nr.	THREUNIV
Draadhoekinstelling (V-draad)	° 55 o. 60
Voor aantal stappen (Rechte hoek)	per inch 2 - 2,5 - 3 - 3,5 - 4 - 4,5 - 5 - 6 - 7 - 8
Voor stijgingen (30° hoek)	mm 2 - 3 - 4 - 5 - 6 - 7 - 8 - 9 - 10 - 12
Prijs	€ 18,50

Mallen



Schroefdraadmal. Voor type draad. Voor binnen- en buitenmaten.

Order nr.	Orig. nr.	Type draad	Hoek	Aantal bladen	Voor type draad per inch	Voor stijgingen mm	Prijs €
25801002	SDM28W	W	°	55	28	4-62	9,90
25801200	SDM24M	M/UNC		60	55	4-42	13,50
25801101	SDM55MUNC	M		60	24	2,5-6	8,30
25801309	SDM30UNC	M		60	24	4-42	10,50
25801408	SDM6PIPE	G-pipe (R)		55	6	8-28	4,20



Radiusmallen. Ter controle van holle en bolle oppervlaktes.

Order nr.	25841008	25841107	25841206
Orig. nr.	RADGA7	RADGA15	RADGA25
Aantal bladen	17+17	16+16	15+15
Voor radius	mm 1-7	7,5-15	15,5-25
Intervallen	mm (1-3)=0,25 en (3-7)=0,5	0,5	(15,5-20)=0,5 en (20-25)=1
Prijs	€ 14,90	15,90	15,90

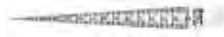

Openingsmal. Voor het meten van kegelvormige gaten. Matverchroomde schaalverdeling-inox lichaam.

Order nr.	14411003
Orig. nr.	DIK15S
Schaalverdeling	mm 1-15
Lezen	mm 0,1
Schaalverdeling	mm 1-15
Dikte	mm 1,2
Prijs	€ 29,90



Openingsmal. Gehard en geslepen staal. Kegelvormigheid 1:10. Direct afleesbaar 0,1 mm. Nonius afleesbaar 0,01 mm. Geleverd met een beschermhuls voor de meetnaald.

Order nr.	26410209
Orig. nr.	DIKONE
Voor diameter	mm 0 - 5
Prijs	€ 190,00



Profielmal. Om een afdruk te maken van het gewenste profiel bij ronde of onregelmatige lijnen. Bij het leggen van tapijt en vloeren, het maken van kasten en banken, bochten, etc. Ronde pinnen in roestvrij staal.

Order nr.	97390108	97390207
Orig. nr.	PFM150	PFM300
Lengte	mm 150	300
Maximum profiel diepte	mm 48	105
Prijs	€ 30,90	118,00



Digitale radiusmeter.

Kenmerken:

- Geschikt voor het meten van sferische objecten
- Meet zowel convexe als concave oppervlaktes
- Gemakkelijk te gebruiken

Order nr.	230470106
Orig. nr.	LIMIT5700
Voor radius	mm 6-700
Nauwkeurigheid	+2%
Digitaal	✓
Prijs	€ 310,00

TOOLS

Graveermachines

Limit



Elektrisch graveerapparaat.

Kenmerken:

- Isolatieklasse II.
- 230 V.

Werking:

- Trilt teneinde stippen te maken.
- Met klem voor vastzetten van punten en besturingsregeling voor gewenste bewegingsafstand, om zowel diepte als breedte van de inslagen te wijzigen.

Geschikt voor:

- Kan gebruikt worden op de meeste materialen zoals metaal, glas, porselein, plastic, hout, leder e.d.
- Voor het markeren van objecten tegen diefstal. Bij een continu gebruik dient het apparaat na 20 minuten stilgelegd te worden voor een periode van 30 minuten.

Geleverd met 4 graveerpunten voor metaal.

Order nr.	85140101	
Orig. nr.	HE100	
Trilfrequentie	slagen/min	6000
Verbruik	W	20
Afmetingen (l x b x h)	mm	300 x 300 x 70
Prijs	€	149,00

Limit



Accessoires voor graveerapparaat. 7400119: Hardmetalen punt met extra fijne top voor glas en metaal. 7400041: 2 hardmetalen punten (extra hard) met ruwe punt voor harde metalen. 90275: Een ring voor verbinding van hardmetalen en diamanten punten in het graveergereedschap. A8: Slijppunt en bevestigingsring.

Order nr.	Orig. nr.	Powerline nummer	Afmetingen (l x b x h) mm	Prijs €
65610404	TIP7400119	7400119	300 x 300 x 70	39,50
65610206	TIP74041	7400041	300 x 300 x 70	46,90
65611105	TIPA8	A8	300 x 300 x 70	38,50
65611106	65611106	90275		57,50

Stempelsets

Limit



Cijferstempelset. Bevat 9 stempels met de cijfers van 0 tot en met 9. 1733: Geharde graveerzone tot 58-60 HRC. 5175: Geharde graveerzone tot 60-61 HRC.

Order nr.	Orig. nr.	Hoogte cijfers	Schacht vierkant		Hardheid graveerzone HRC	Aantal stuks	Prijs €
			mm	mm			
17330101	CSS2	2	6		58-60	9	21,50
17330200	CSS3	3	6		58-60	9	21,50
17330309	CSS4	4	7		58-60	9	21,50
17330408	CSS5	5	8		58-60	9	26,50
17330507	CSS6	6	9		58-60	9	26,50
17330606	CSS8	8	11		58-60	9	40,90
17330705	CSS10	10	12		58-60	9	72,90
17330804	CSS12	12	14		58-60	9	79,90
17330903	CSS15	15	16		58-60	9	135,00
51750107	CSSXL2	2	7		60-61	9	71,90
51750206	CSSXL3	3	8		60-61	9	71,90
51750305	CSSXL4	4	9		60-61	9	79,90
51750404	CSSXL5	5	10		60-61	9	83,90
51750503	CSSXL6	6	12		60-61	9	105,00
51750602	CSSXL8	8	14		60-61	9	129,00
51750701	CSSXL10	10	16		60-61	9	166,00

Limit



Letterstempelset. Bevat de 26 letters van A tot Z en het teken & . 1735 : Geharde stempelzone tot 60-63 HRC . 5176 : Geharde stempelzone tot 60-61 HRC.

Order nr.	Orig. nr.	Schacht vierkant	Hardheid graveerzone HRC	Aantal stuks	Hoogte letters mm	Prijs €
17350109	STA2	6	60-63	26	2	51,50
17350208	STA3	6	60-63	26	3	51,50
17350307	STA4	7	60-63	26	4	51,50
17350406	STA5	8	60-63	26	5	70,90
17350505	STA6	9	60-63	26	6	70,90
17350604	STA8	11	60-63	26	8	109,00
17350703	STA10	12	60-63	26	10	147,00
17350802	STA12	14	60-63	26	12	240,00
17350901	STA15	16	60-63	26	15	378,00
51760106	STAL2	7	60-61	26	2	202,00
51760205	STAL3	8	60-61	26	3	213,00
51760304	STAL4	9	60-61	26	4	225,00
51760403	STAL5	10	60-61	26	5	246,00
51760502	STAL6	12	60-61	26	6	330,00
51760601	STAL8	14	60-61	26	8	374,00
51760700	STAL10	16	60-61	26	10	499,00



Complete stempelset met stempelhouder bestaande uit 58 letters, 35 cijfers en 7 speciale merktekens

Order nr.	Orig. nr.	Hoogte mm	Capaciteit houder	Lengte mm	Prijs €
58890104 ^M	STS3	3	10	40	865,00
58890203 ^M	STS4	4	8	40	925,00
58890302 ^M	STS5	5	6	40	979,00



Letter- en cijfersjablonen. Met sluitgroef voor assemblage. De cijferset bevat 15 stempels waaronder cijfers van 0 tot en met 9, een koppelteken, een extra nul, een punt en twee eindstukken. De letterset, bevat 36 stempels waaronder letters van A tot en met Z, een koppelteken, een punt, een en-teken, een spatie en twee eindstukken. De stempels worden enkel verkocht in volledige sets.

Order nr.	Orig. nr.	Hoogte teken mm	Type	Aantal	Prijs €
17320102 ^M	CC25	25	Cijfer	15	35,90
17320409 ^M	CC38	38	Cijfer	15	44,90
17320607 ^M	CC50	50	Cijfer	15	54,50
17320805 ^M	CC62	62	Cijfer	15	63,50
17321209 ^M	CC78	75	Cijfer	15	84,90
17321258 ^M	CC100	100	Cijfer	15	125,00
17321308 ^M	CAL25	25	Letter	36	99,90
17321605 ^M	CAL38	38	Letter	36	117,00
17321803 ^M	CAL50	50	Letter	36	143,00
17322009 ^M	CAL62	62	Letter	36	156,00
17322405 ^M	CAL75	75	Letter	36	200,00
17322454 ^M	CAL100	100	Letter	36	230,00

Markeerkrijt



Markeerkrijt. Voor het markeren van staal of andere metalen. Kan ook gebruikt worden op buiten gestokeerd metaal of metaal dat heropgewarmd moet worden. Wordt niet verwijderd door vuur of water. Kleur: wit. Rechthoekig (130x13x5). 100 stuks.

Order nr.	166380105 ^M
Orig. nr.	LK130
Prijs	€ 27,50



Industrieel krijt. Stofvrij. Magnesium. Voor markering op metaal e.d. Smelt niet bij verhitting. Rechthoekig (90x12x12). Kleur: wit. VE = Verpakkingseenheid.

Order nr.	24690109 ^M
Orig. nr.	CHALK50
VE	50
Prijs/VE	€ 42,50



Geperste houder met clip. Vernikkeld. Geschikt voor krijt 166380105. Lengte 145mm.

Order nr.	166480103 ^M
Orig. nr.	LKH130
Prijs	€ 4,70

Markeerstiften



Markeerstift. Artline 400-XF. Voor duurzame markering en belettering op moeilijke oppervlaktes zoals metaal, plastic, glas, rubber, e.d. . Kan buiten gebruikt worden en op moeilijke plaatsen . Extra kleuroverdekkend . Ronde punt 2mm. Sneldrogend . VE = verpakkingseenheid. Xyleen vrij.

Order nr.	Orig. nr.	Artline 400-XF	Temperatuur- bestendig °	VE	Prijs/VE €
27100106 ^M	ART400BLCK	zwart	370	12	79,50
27100155 ^M	ART400RE	rood	290	12	79,50
27100171 ^M	ART400GR	groen	290	12	79,50
27100205 ^M	ART400WH	wit	260	12	79,50
27100254 ^M	ART400BL	blauw	290	12	79,50
27100304 ^M	ART400YE	geel	290	12	79,50



Markeerstift Artline 725. Voor markering op poreuse en harde oppervlaktes. Zelfs op glanzende oppervlaktes. Fijne punt - 0,4 mm. Waterproof en Sneldrogend. Extra luchtdichting in dop. Met clip. Xyleen-vrij. Verkleurt niet. VE = verpakkingseenheid.

Order nr.	Orig. nr.	Artline 725	VE	Prijs/VE €
23630106 ^M	ART725BLCK	zwart	12	44,50
23630205 ^M	ART725RE	rood	12	44,50
23630304 ^M	ART725BL	blauw	12	44,50

Slangklemmen



VERZINKT STAAL

100-delige display van standaard staalverzinkte slangklemmen bestaande uit 10 x 10 verschillende maten.

Order nr.	745661000 €
Aantal stuks	100
Bevat	10 stuks elks 9.5-12 / 11-16 / 13-20 / 16-22 / 18-25 / 22-30 / 25-35 / 30-40 / 35-50 / 40-55mm
Prijs	€ 97,50



RVS

100-delige Jubilee display van roestvrijstalen slangklemmen bestaande uit 10 x 10 verschillende maten.

Order nr.	745661001 €
Aantal stuks	100
Bevat	10 stuks elks 9.5-12 / 11-16 / 13-20 / 16-22 / 18-25 / 22-30 / 25-35 / 30-40 / 35-50 / 40-55mm
Prijs	€ 273,00



VERZINKT STAAL

32-delige set van staalverzinkte standaard slangklemmen in stevige ABS-koffer.

Order nr.	745661432 €
Orig. nr.	JUBOX032
Aantal stuks	32
Bevat	6 x 9.5-12 / 6 x 11-16 / 6 x 13-20 / 4 x 16-22 / 4 x 18-25 / 2 x 22-30 / 2 x 25-35 / 2 x 30-40mm
Prijs	€ 29,90



VERZINKT STAAL

143-delige set van staalverzinkte standaard slangklemmen in stevige ABS-koffer.

Order nr.	745661430 €
Orig. nr.	JUBOX143
Aantal stuks	143
Bevat	24 x 9.5-12 / 32 x 11-16 / 28 x 13-20 / 13 x 16-22 / 14 x 18-25 / 12 x 22-30 / 13 x 25-35 / 7 x 30-40mm
Prijs	€ 135,00



VERZINKT STAAL

54-delige set JUNIOR slangklemmen in stevige ABS-koffer.

Order nr.	745661433 €
Orig. nr.	JUBOX054
Aantal stuks	54
Bevat	6 x 7.9 / 6 x 8-10 / 6 x 9-11 / 8 x 10-12 / 10 x 11-13 / 6 x 13-15 / 8 x 12-14 / 4 x 14-16 mm
Prijs	€ 29,90



VERZINKT STAAL

165-delige set JUNIOR slangklemmen in stevige ABS-koffer.

Order nr.	745661650 €
Aantal stuks	165
Bevat	25 x 7.9 / 25 x 8-10 / 25 x 9-11 / 30 x 10-12 / 30 x 11-13 / 30 x 12-14mm
Prijs	€ 89,50



VERZINKT STAAL

175-delige set O-CLIPS slangklemmen in stevige ABS-koffer.

Order nr.	745661750 €
Aantal stuks	175
Bevat	20 x 5-7 / 20 x 7-9 / 20 x 8-11 / 20 x 9-11 / 20 x 11-13 / 15 x 13-15 / 20 x 15-17 / 20 x 15-18 / 20 x 17-20mm
Prijs	€ 79,50



VERZINKT STAAL



Stalen slangklemmen. Standaard versie.

Kenmerken

- Verzinkte uitvoering
- Breedte 13mm (9 mm voor kleine maten)
- Corrosie resistentie: 240 uren
- Schroef 7mm
- Conform DIN3017, BS5315

Geschikt voor

- Automotive
- Industrie: pneumatisch en hydraulische toepassingen
- DIY toepassingen
- Bouw
- Landbouw

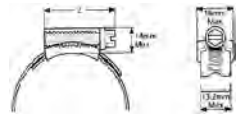

EQUIPMENT



RVS



Stalen slangklemmen. Light versie.

Kenmerken:

- Verzinkte uitvoering.
- Breedte 9,9 mm.
- Banddikte 0,76mm.
- Conform DIN 3017 norm.

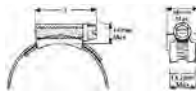

VE = verpakkingseenheid.

Order nr.	Capaciteit	Bandbreedte	Banddikte	Z maximum	VE	Prijs/VE
	mm	mm	mm	mm		€
745681304	14 - 22	9,9	0,76	24	20	18,90
745681507	16-27	9,9	0,76	26	1	19,90
745681607	20 - 32	9,9	0,76	24	20	19,90
745681809	30 - 40	9,9	0,76	28	20	21,90
745681910	35 - 45	9,9	0,76	28	20	21,90
745682011	35 - 50	9,9	0,76	28	20	24,50
745682213	45 - 60	9,9	0,76	33	20	25,50
745682314	55 - 70	9,9	0,76	33	20	26,50
745682415	60 - 80	9,9	0,76	33	1	1,50
745682516	70 - 90	9,9	0,76	33	1	1,50
745682617	80 - 100	9,9	0,76	33	1	1,80
745682718	90 - 110	9,9	0,76	33	1	1,80
745682819	100 - 120	9,9	0,76	33	1	1,90
745682920	110 - 130	9,9	0,76	33	1	2,00
745683021	120 - 140	9,9	0,76	33	1	2,00
745683122	130 - 150	9,9	0,76	33	1	2,10
745683223	140 - 160	9,9	0,76	33	1	2,20

Order nr.	Capaciteit	Bandbreedte	Doos nummer	Z maximum	VE	Prijs/VE
	mm	mm		mm		€
745731001	9,5-12	9	000	21	10	8,90
745731102	11-16	9	MOO	21	10	8,90
745731203	13-20	9	OO	21	10	9,50
745731304	16-22	13	O	25	10	11,50
745731405	18-25	13	OX	25	10	11,50
745731506	22-30	13	1A	29	10	12,50
745731607	25-35	13	1	29	10	12,90
745731708	30-40	13	1X	29	10	12,90
745731809	32-45	13	1M	29	10	12,90
745731910	35-50	13	2A	33	10	14,50
745732011	40-55	13	2	33	10	14,50
745732112	45-60	13	2X	33	10	15,50
745732213	55-70	13	3	33	10	16,50
745732314	60-80	13	3X	33	1	1,80
745732415	70-90	13	4	33	1	1,80
745732516	85-100	13	4X	33	1	2,00
745732617	90-120	13	5	33	1	2,10
745732718	110-140	13	6	33	1	2,40
745732819	130-150	13	6X	33	1	2,50
745732920	135-165	13	7	33	1	2,50
745733021	158-190	13	7,5	33	1	3,10
745733122	184-216	13	8,5	33	1	3,50
745733223	210-242	13	9,5	33	1	3,80
745733324	235-267	13	10,5	33	1	4,10
745733425	260-292	13	11,5	33	1	4,50
745733526	286-318	13	12,5	33	1	4,70



RVS

Roestvrijstalen slangklemmen. Light versie.

Kenmerken:

- RVS staal type 316.
- BS1449PT.2 DIN 14401 A4
- Breedte 9,9 mm.

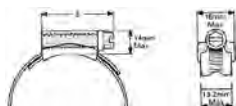

VE = verpakkingseenheid.

Order nr.	Capaciteit	Bandbreedte	Banddikte	Z maximum	VE	Prijs/VE
	mm	mm	mm	mm		€
745671304	14 - 22	9,9	0,76	24	20	55,90
745671405	16 - 25	9,9	0,76	24	20	55,90
745671506	22 - 30	9,9	0,76	24	20	59,90
745671607	20 - 32	9,9	0,76	24	20	60,90
745671708	25 - 35	9,9	0,76	28	20	61,90
745671809	30 - 40	9,9	0,76	28	20	62,90
745671910	35 - 45	9,9	0,76	28	20	67,50
745672011	35 - 50	9,9	0,76	28	20	71,50
745672112	40 - 55	9,9	0,76	33	20	74,50
745672213	45 - 60	9,9	0,76	33	20	77,50
745672314	55 - 70	9,9	0,76	33	20	83,90
745672415	60 - 80	9,9	0,76	33	1	4,50
745672516	70 - 90	9,9	0,76	33	1	4,70
745672617	80 - 100	9,9	0,76	33	1	4,80
745672718	90 - 110	9,9	0,76	33	1	5,10
745672819	100 - 120	9,9	0,76	33	1	5,60
745672920	110 - 130	9,9	0,76	33	1	5,70
745673021	120 - 140	9,9	0,76	33	1	5,90
745673223	140 - 160	9,9	0,76	33	1	6,50



RVS

Roestvrij stalen slangklemmen. Standaard versie.

Kenmerken

- Roestvrij staal
- Breedte 13mm (9 mm voor kleine maten)
- Conform DIN3017, BS5315
- Hoge corrosie resistentie (RVS): 1000 uren
- Schroef: 7mm

Geschikt voor de meest voorkomende toepassingen, zoals:

- Automotive
- Industrie: pneumatisch en hydraulische toepassingen
- DIY toepassingen
- Bouw
- Landbouw
- Maritieme sector
- Olie en gas
- Voedingssector



VE = verpakkingseenheid

Order nr.	Capaciteit	Bandbreedte	Doosnummer	Z maximum	VE	Prijs/VE
	mm	mm		mm		€
745721001	9,5-12	9	OOO	21	10	27,50
745721102	11-16	9	MOO	21	10	27,50
745721203	13-20	9	OO	21	10	27,90
745721304	16-22	13	O	25	10	32,50
745721405	18-25	13	OX	25	10	32,50
745721506	22-30	13	1A	29	10	33,50
745721607	25-35	13	1	29	10	36,90
745721708	30-40	13	1X	29	10	36,90
745721809	32-45	13	1M	29	10	39,50
745721910	35-50	13	2A	33	10	41,90
745722011	40-55	13	2	33	10	43,90
745722112	45-60	13	2X	33	10	45,90
745722213	55-70	13	3	33	10	49,50
745722314	60-80	13	3X	33	1	5,20
745722415	70-90	13	4	33	1	5,60
745722516	85-100	13	4X	33	1	5,70
745722617	90-120	13	5	33	1	6,40
745723021	158-190	13	7,5	33	1	8,60
745723223	210-242	13	9,5	33	1	11,50
745723526	286-318	13	12,5	33	1	13,90



RVS

Hight Torque slangklemmen. Roestvrijstalen uitvoering.

Kenmerken:

- Aanspankoppel is 2x groter dan bij de normale slangklem.
- Geleverd per stuk.

Geschikt voor:

- De zeer veeleisende industriële toepassing.

Order nr.	Capaciteit mm	Prijs €
745742035 €	20-35	9,10
745742540 €	25-40	9,30
745743050 €	30-50	9,50
745744070 €	40-70	10,00
745746080 €	60-80	10,50
745747095 €	70-95	11,50
745740100 €	80-100	11,50
745740120 €	90-120	11,50
745740140 €	110-140	12,50
745740160 €	130-160	12,50
745740180 €	150-180	13,50
745740200 €	170-200	14,50
745740220 €	190-220	14,50
745740240 €	210-240	15,50
745740260 €	230-260	15,50
745740280 €	250-280	18,50
745740300 €	270-300	18,50
745740320 €	290-320	19,50
745740340 €	310-340	17,90
745740360 €	330-360	18,50
745740380 €	350-380	18,90
745740460 €	430-460	21,90
745740480 €	450-480	21,90
745740500 €	470-500	22,50



VERZINKT STAAL

Wingspade slangklem met kunststof vleugelmoer.

Kenmerken:

- Band, schroef en huis in verzinkt staal.

VE = verpakkingseenheid.

Order nr.	Capaciteit mm	VE	Prijs/VE €
745600812 €	8-12	20	34,50
745601017 €	10-16	20	34,90
745601220 €	12-20	20	34,90
745601625 €	16-25	20	31,50
745602032 €	20-32	20	35,50
745602540 €	25-40	20	37,50
745603250 €	32-50	20	37,50
745604060 €	40-60	20	40,50
745605070 €	50-70	20	44,90



VERZINKT STAAL

Junior slangklemmen. Staalverzinkte uitvoering.

Kenmerken:

- 9mm brede band.
- Band BS1449CS.
- Schroef 7mm.
- Max. kracht 1,2Nm.

Geschikt voor:

- Bvb kleine brandstofleidingen ed.

VE = verpakkingseenheid.

Order nr.	Capaciteit mm	VE	Prijs/VE €
745691001 €	7-9	50	34,50
745691102 €	8-10	50	34,50
745691203 €	9-11	50	34,50
745691304 €	10-12	50	34,50
745691405 €	11-13	50	34,50
745691506 €	12-14	50	34,50
745691607 €	13-15	50	34,50
745691708 €	14-16	50	36,90
745691809 €	15-17	50	36,90
745691910 €	16-18	50	36,90

EQUIPMENT



VERZINKT STAAL



Superslangklem extra-zware uitvoering.

Kenmerken:

- Staalverzinkte stalen uitvoering (ook leverbaar in roestvrijstalen uitvoering op aanvraag).
- Geleverd per stuk.

Order nr.	Capaciteit	Bandbreedte	Banddikte	Aanbevolen		Schroef	Prijs
				Nm	torsie		
	mm	mm	mm	Nm	mm	mm	€
745661720	17-19	18	0.60	6	8	8	2,20
745662325	23-25	18	0.60	6	8	8	2,40
745662931	29-31	18	0.60	6	8	8	2,50
745663639	36-39	18	0.60	6	8	8	2,80
745664043	40-43	18	0.60	6	8	8	3,40
745664447	44-47	20	1.00	8	10	3,50	
745664851	48-51	20	1.00	8	10	3,50	
745665255	52-55	20	1.00	8	10	3,70	
745665659	56-59	20	1.00	8	10	3,80	
745666467	64-67	20	1.00	8	10	4,70	
745666873	68-73	20	1.00	8	10	4,70	
745667479	74-79	20	1.00	8	10	5,50	
745668085	80-85	20	1.00	8	10	5,50	
745669297	92-97	25	1.50	25	13	5,70	
745660103	98-103	25	1.50	25	13	5,80	
745660112	104-112	25	1.50	25	13	5,90	
745660130	122-130	25	1.50	25	13	6,20	
745660139	131-139	25	1.50	25	13	6,40	
745660148	140-148	25	1.50	25	13	6,40	
745660161	149-161	25	1.50	25	13	6,80	
745660174	162-174	25	1.50	25	13	7,20	



VERZINKT STAAL



2-Oorslangklemmen: O-clips. Systeem Oetiker. Staalverzinkte uitvoering.

Kenmerken:

- Voor slangbevestigingen in lage en middeldruk.

VE = verpakkingseenheid.

Order nr.	Capaciteit	VE	Prijs/VE
	mm		€
745701304	5,0-7,0	50	23,90
745701405	7,0-9,0	50	26,50
745701506	8,0-11,0	50	26,50
745701607	9,0-11,0	50	28,90
745701708	11,0-13,0	50	28,90
745701809	13,0-15,0	50	31,50
745701910	15,0-17,0	50	31,50
745702011	15,0-18,0	50	34,50
745702112	16,0-19,0	50	36,90
745702213	17,0-20,0	50	36,90
745702314	19,0-22,0	50	49,90
745702415	20,0-23,0	50	49,90
745702516	22,0-25,0	25	27,90
745702617	23,0-27,0	25	28,90
745702718	25,0-28,0	25	28,90
745702819	27,0-31,0	25	31,50
745702920	28,0-31,0	25	31,50
745703021	31,0-34,0	25	33,50
745703122	34,0-37,0	25	34,50
745703324	40,0-43,0	25	36,90
745703425	43,0-46,0	25	38,50



VERZINKT STAAL

Multi-band: maak uw eigen slangklem op de gewenste lengte met de multi-band.

Assortiment met een slangklemmenband met schroeven en dito schroefhuls. Slangklemmenband is in verzinkte en stalen uitvoering - breedte 11 mm.

Order nr.	Aantal schroeven	Lengte m	Prijs €
745651100 €	25	10	69,50
745747104 €	100	-	109,00
745747102 €	0	10	43,90
745747103 €	0	30	107,00



RVS

Multiband RVS: maak uw eigen slangklem op de gewenste lengte met de multi-band.

Assortiment met een slangklemmenband met schroeven en dito schroefhuls. Slangklemmenband is in RVS - breedte 11 mm.

Order nr.	745747101 €	745651102 €	745651101 €
Aantal schroeven	25	100	0
Lengte m	10	-	30
Prijs €	129,00	196,00	172,00



Jubilee tang voor oors-slangklemmen.

Kenmerken:

- Normale sluiting (JUCLP)
- Zijsluiting (JUCLPS): voor moeilijk bereikbare klemmen.

Order nr.	745661030 €	745747107 €
Orig. nr.	JUCLP	JUCLPS
Prijs €	47,90	47,90

TENGTOLS



Schroevendraaier voor slangklemmen. Met flexibele schacht voor een goede toegankelijkheid. Met omwisselbare dop van 6 en 7mm. Totale lengte 275mm.

Order nr.	199910100 †
Orig. nr.	MD503N
Capaciteit mm	6-7
Lengte mm	275
Prijs €	13,30

TENGTOLS



Schroevendraaier voor slangklemmen. Totale lengte 275mm.

Kenmerken:

- Met flexibele schacht voor een goede toegankelijkheid.
- Met dop van 7mm.

Order nr.	199910209 †
Orig. nr.	MD503NA
Capaciteit mm	7
Lengte mm	275
Prijs €	10,30

TENGTOLS



Schroevendraaier voor slangklemmen. Totale lengte 275mm.

Kenmerken:

- Met flexibele schacht voor een goede toegankelijkheid.
- Met dop van 8mm.

Order nr.	199640103 †
Orig. nr.	MD503ND
Capaciteit mm	8
Lengte mm	275
Prijs €	10,50



Jubilee Flexdriver. Schroevendraaier voor slangklemmen, geschikt voor Jubilee slangklemmen.

Voordelen:

- Snelle en gemakkelijke instelling van de Jubilee slangklemmen
- Hoog kwaliteitsproduct
- Flexibele schacht vergemakkelijkt het werk in ontoegankelijke hoekjes

Order nr.	745661010 €
Aantal stuks	2
Bevat	Jubilee flexdriver
Aansluiting mm	7
Lengte mm	280
Prijs €	19,50

TENGTOLS



Bi-ervangdop 6 en 7mm voor MD503.

Order nr.	61180207 †
Orig. nr.	MD503RK
Prijs €	1,30

LED handlampen

EQUIPMENT



Super compacte en veelzijdige LED zaklamp.

Kenmerken:

- 80 lumen lichtopbrengst op zijkant en 10 lumen spot op bovenkant van de zaklamp.
- Geselecteerde SMD LEDS met lange autonomie.
- Grote lichthoek 120° (zijkant) en 40° bundel (bovenkant).
- Met 2 sterke magneten op rug en voet, en draagclips voor broekzak of riem.
- Werkt op 3xAAA standaard batterijen.
- Anti-slip rubberhandvat.

Verkocht per 16 stuks in een display.

Order nr.	801106032	
Orig. nr.		WLP80
Levensduur	h	10000
Lichtsterkte	lumen	80
Autonomie	h	3
VE		1
Min. bestelhoeveelheid		16
Prijs/VE	€	9,90



Zaklamp LED 100 lm, herlaadbaar.

Kenmerken:

- Gloeilamp 1W COB LED 100 lumen
- Herlaadbare 3,7 V 750 mAh Li-ion batterij, met micro-USB laadpoort (lader niet inbegrepen)
- Behuizing in stevig aluminium en PVC
- Magnetische clip

Geleverd in een display per 12 stuks.

Order nr.	801106065	
Orig. nr.		WLP100
Lengte	mm	165
Lichtsterkte	lumen	100
Autonomie	h	3
Opladtid	h	2,5
VE		1
Min. bestelhoeveelheid		12
Prijs/VE	€	19,90

TOOLS

NEW

**LUMEN
170-80**



Handlamp draaibaar LED 170 Lm, herlaadbaar.

Kenmerken:

- 5 SMD LEDs
- 170 lumen (hoog) / 80 lumen (laag)
- Herlaadbare 3,7 V 1500 mAh Lithium batterij met micro-USB laadpoort (lader niet inbegrepen)
- Sterke magneet en 180° draaibaar
- Riemclip en draaibare haak

Geleverd in een display per 12 stuks

Order nr.	801106066 €
Orig. nr.	WL170
Lengte	mm 125
Puissance d'éclairage	lumen 170/80
Autonomie	h 4
Oplaadtijd	h 3
VE	1
Min. bestelhoeveelheid	12
Prijs/VE	€ 24,90

TOOLS



Set USB lader 230 V voor lampen WLP100 en WL170

Set bevat:

- USB lader 230 V, output 5 V 500 mA
- 1,5 m USB kabel met micro-USB output

Order nr.	801106067 €
Orig. nr.	WLCH
Prijs	€ 6,90

TOOLS

**LUMEN
250**



Handlamp met superkrachtige COB LED 4W.

Kenmerken:

- Draadloos met heroplaadbare Li-ion 1800mAh batterij.
- Met AC (230V) en DC (12V) oplader en LED laadindicator.
- Quasi onbreekbare polycarbonaat cover, geïntegreerde riemclip en multifunctionele haak.
- Handig en compact.

Verkocht per 10 stuks in een display.

Order nr.	801106010 €
Orig. nr.	WL0010S
Lengte	mm 185
Kleurtemperatuur	K 8000
Lichtsterkte	lumen 300
Autonomie	h 2,5
Oplaadtijd	h 4
VE	1
Min. bestelhoeveelheid	10
Prijs/VE	€ 34,90

EQUIPMENT



ULTRA BRIGHT

**LUMEN
600-300**



Super krachtige LED looplamp met herlaadbare batterijen.

600 lumen fel witte lichtbundel zorgt voor een royaal en ruim verlicht werkgebied in alle omstandigheden.

- Brede lichtbundel 120° die het ganze gezichtsveld bereikt.
- 12 SMD LEDS gekenmerkt door lange levensduur (door lage opwarming).
- 2 lichtstanden: 100% en 50% voor langere standtijd.
- Met herlaadbare li-ion battery 3.7V 2200mAh, oplaadbaar via AC (230V)- en DC- (12V) auto-oplader.
- Met krachtige rugmagneet en 360° draaibare, onbreekbare nylon haak bovenaan.
- Onbreekbare cover uit polycarbonaat.
- Anti-slip handvat.
- Geleverd met extra lampsteun voor het rechtop zetten van de lamp

Verkocht per 8 stuks in een display.

Order nr.	801106060		
Orig. nr.		WIT600	
Levensduur	h	10000	
Lichtsterkte	lumen	600	
Autonomie	h	4-8	
VE		1	
Min. bestelhoeveelheid		8	
Prijs/VE	€	33,90	



**MODE
ALARM FLASHING**

**MODE
POWER SAVING**

**LUMEN
100**

Krachtige 100 Lumen **hoofdlamp**.

Kenmerken:

- incl. 3 x AAA batterijen.
- 3 standen: witte en rode alarmverlichting.
- Inclusief hoofdband.

Geleverd in een display per 10 stuks.

Order nr.	801106030		
Orig. nr.		HL100	
LED wattage	W	3	
Levensduur	h	10000	
Lichtsterkte	lumen	100	
VE		1	
Min. bestelhoeveelheid		10	
Prijs/VE	€	5,70	

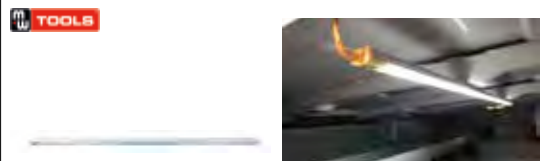

Magnetische LED lamp met schakelaar.

Geschikt voor:

- Verlichting in bestelwagens, auto's, ...

Voordelen:

- Zeer krachtige LED lamp
- Geeft zeer helder licht

Geleverd met:

- 12V kabel
- Bevestigingsclips

Order nr.	940014331		
Orig. nr.		LED100	
Lengte	mm	1000	
LED wattage	W	15	
Spanning	V	12	
Lichtsterkte	lumen	1200	
Prijs	€	79,50	

TENGOOLS



LED-looplamp met pocket-clip.

Kenmerken:

- Voorzien van 3 hoogkwalitatieve LED-diodes.
- Handig zakmodel lamp.
- 2 x AAA batterij.

Batterijen niet meegeleverd.

Order nr.	144330107	
Orig. nr.	584	
Lengte	mm	130
Batterijen	2 x AAA	
Prijs	€	20,90

TENGOOLS



LED-looplamp.

Kenmerken:

- 25-30 Lumen.
- Focus lens 45 graden.

Batterij AAA niet inbegrepen.

Order nr.	132390105	
Orig. nr.	585	
Batterijen	3 x AAA	
Levensduur	h	5,5
Lichtsterkte	lumen	30
Prijs	€	21,50

TENGOOLS



Zwarte LED zaklamp Cree. Met extra lange duur. Batterij niet meegeleverd.

Order nr.	172310104	172310302
Orig. nr.	581	583
Lengte	mm	107
LED wattage	W	1
Batterijen	2 x AA	
Lichtsterkte	lumen	60
Prijs	€	30,90

TENGOOLS



Zaklamp Cree met witte LED.

LUMEN
250-100

Kenmerken:

- Gemaakt van vliegtuig aluminium
- Controlelampje dat van groen tot rood verandert wanneer de batterijen capaciteit lager is dan 15%
- Beschermingsklasse IPX6

Batterijen niet inbegrepen (3 x AAA)

Order nr.	199780206	
Orig. nr.	582N	
Lengte	mm	138
LED wattage	W	1-3
Batterijen	3 x AAA	
Lichtsterkte	lumen	100/250
Prijs	€	38,90

TENGOOLS



Flexibele LED lamp met magneet.

Kenmerken:

- Met 3 LEDs.

3 x LR44 niet meegeleverd.

Order nr.	167910108	
Orig. nr.	587M	
Lengte	mm	370
Batterijen	3 x LR44	
Diameter	mm	25
Lichtsterkte	lumen	76,5
Prijs	€	13,90

TENGOOLS



Flexibele werk lamp.

Kenmerken:

- Met lang flexibel handvat.
- Magnetisch.
- Te gebruiken met batterijen 2 x R6.
- Voor mobiel gebruik in gesloten ruimte.

Batterijen niet meegeleverd.

Order nr.	69060101	
Orig. nr.	586	
Lengte	mm	595
Batterijen	2 x R6	
Diameter	mm	10
Lengte kabel	mm	400
Prijs	€	43,90

TENGOOLS



LED lamp met magneet.

Order nr.	199660101	
Orig. nr.	587J	
Lengte	mm	255
Batterijen	3 x AA	
Diameter	mm	40
Prijs	€	53,90

Lashelmen

MACH



MMA
MIG-MAG

Automatische lashelm voor MIG, MMA en elektrodelassen.

Voordelen:

- Complete bescherming van ogen en hals tegen straling en vonken tijdens het lassen.
- Onbreekbare en buigzame nylon kap.
- Comfortabele hoofdband.
- Glanzende gelakte afwerking voor gemakkelijk reinigen.

Kenmerken:

- Kijkvenster van 90x35mm.
- Hoge filterklasse 1/1 / 1/2 van de cassette garandeert minimale schadelijke instraling en een maximale helderheid van het zichtvenster.
- 1 regeling op de buitenkant van de kap: DIN 9-13.
- Energiebron: zonnecellen + vervangbare knooppellen.
- Batterij met levensduur tot 5000h.
- 2 sensoren voor detectie van vlamboog.

Order nr.	829000015 €	
Orig. nr.	PROTECT413	
Zichtvenster	mm	90x35
Stroom	zonne-energie en batterij	
DIN waarde	DIN	9 - 13 (traploos)
Omschakel reactietijd (helder naar donker)	s	0,0005
Afmetingen cassette	mm	8x5
Werkbereik	A	>15
Optische klasse	1/1/1/2	
MIG	✓	
MMA	✓	
Vertraging	s	0,1 - 0,7 (auto)
Ultraviolet bescherming	%	0,0003 (313nm)
Infrarood bescherming	%	0,01 (780-2000nm)
Gebruikstemperatuur	°C	-10 - 60
Sensoren	2	
Certificaat	CE EN379 ANSIZ87.1	
Bescherming	DIN	15
Prijs	€	40,50

MACH

NEW

MMA

MIG-MAG

TIG + SLIJPEN



Automatische lashelm voor alle procédés (MIG, MMA, TIG), ook voor plasmasnijden, autogeen lassen, puntlassen en slijpen.

Bijzonder groot zichtvenster 100 x 67 mm.

Complete bescherming van ogen en hals tegen straling en vonken tijdens het lassen.

Voordelen:

- Zeer ruim en contrastrijk zicht op de werkomgeving
- **DIN: 5-13**
- Zichtvenster 100 x 67 mm
- Zeer hoge filterklasse 1/1/1/2
- Minimale schadelijke instraling
- Comfortabele hoofdband met dubbele scharnieren voor een optimale ergonomie
- Onbreekbare en buigzame nylon kap
- Schakelt foutloos om, ook in lage stroomsterkte vanaf 2 A.

Kenmerken:

- Alle regelknoppen op de buitenkant van de kap
- DIN-waarde 5-13: grote keuze aan helderheden
- Gevoeligheid en vertraging traploos instelbaar
- Grote DIN-regelknop, ideaal om tijdens het lassen snel bij te regelen, zelfs met lashandschoenen aan
- Energiebron: zonnecellen + vervangbare knooppellen
- 4 sensoren voor detectie van vlamboog
- Glanzende gelakte afwerking voor gemakkelijk reinigen

Order nr.	829000035 €	
Orig. nr.	PROTECT670	
Zichtvenster	mm	100x67
Stroom	zonnecellen en knooppellen	
Aan/uit	automatisch	
DIN waarde	DIN	5 - 13 (traploos)
Werkbereik	A	>2
Optische klasse	1/1/1/2	
Batterijalarm	✓	
MIG	✓	
TIG	✓	
MMA	✓	
Slijpen	✓	
Vertraging	s	0,15-0,8 (traploos)
Gebruikstemperatuur	°C	-5+55
Sensoren	4	
Prijs	€	69,00

ACCESSOIRES OP VYNCKIER.BIZ

Schweillichaft



Omhoogklapbare beschermbril voor snijbranders en autogeen lassen.

Kenmerken:

- Zacht en stabiel PVC.
- Ook geschikt voor brildragers.
- Omhoogklapbare DIN-glazen, daaronder kleurloze glazen.
- DIN glazen met een doormeter van 50mm.
- Volgens EN 166 3 4 F 0196 CE.

Order nr.	711600305 €
Orig. nr.	1600305
Sensoren	0
Prijs	€ 18,50

TOOLS



Laskap handmodel. Economy uitvoering.
Geleverd met donker glas 802575.

Order nr.	830802545 €
Orig. nr.	802545
Sensoren	0
Prijs	€ 17,50

Ademhalingsbescherming

TOOLS



Hygiënemasker.
VE = verpakkingseenheid.

Order nr.	850001001 €
Orig. nr.	JOPMA10
Verpakking	carded
VE	10
Prijs/VE	€ 2,00

TOOLS



FIJNSTOFMASKER FFP1.

- conform CE 0086 EN149:2001
 - bevestiging : elastiek
 - regelbare neusclip : aan de binnenkant
 - bescherming tegen calciumcarbonaat-magnesium-cement-zacht hout
 - minimale bescherming tegen onschadelijke vaste-en vloeistofdeeltjes tot 10mg/m³ en tot 4X MDW
- VE = verpakkingseenheid.

Order nr.	850001003 €	850001004 €
Orig. nr.	JOFMP12	JOFMP120
Verpakking	carded	doos
VE	3	20
Prijs/VE	€ 7,10	31,90

TOOLS



FIJNSTOFMASKER FFP2.

- conform CE 0086 EN149:2001
 - bevestiging : elastiek
 - regelbare neusclip : aan de binnenkant
 - bescherming tegen schadelijke stoffen : glasfiber-kwarts-hardhout-zware metalen
 - minimale bescherming tegen schadelijke vaste-en vloeistofdeeltjes tussen 0,1 en 10mg/m³ en tot 10X MDW
- VE = verpakkingseenheid.

Order nr.	850001007 €	850001008 €
Orig. nr.	JOFMP23	JOFMP220
Verpakking	carded	doos
VE	1	20
Prijs/VE	€ 8,10	34,90

TOOLS



FIJNSTOFMASKER FFP2 MET VENTIEL.

- conform CE 0086 EN149:2001
 - bevestiging : elastiek
 - regelbare neusclip : aan de binnenkant
 - met uitademingventiel
 - bescherming tegen schadelijke stoffen in een vochtige omgeving : glasfiber-kwarts-hardhout-zware metalen
 - minimale bescherming tegen schadelijke vaste-en vloeistofdeeltjes tussen 0,1 en 10mg/m³ en tot 10X MDW
- VE = verpakkingseenheid.

Order nr.	850001010 €
Orig. nr.	JOFMP2V1
Verpakking	doos
VE	15
Prijs/VE	€ 46,50



FIJNSTOFMASKER FFP3 MET VENTIEL.

-conform CE 0086 EN149:2001

-bevestiging : elastiek

-regelbare neusclip : aan de binnenkant

-met uitademingventiel

-bescherming tegen giftige stoffen : asbestfiber-zware metalen als nickel, chroom, lood-farmaceutische producten

-minimale bescherming tegen schadelijke vaste-en vloeistofdeeltjes

minder dan 0,1 mg/m3 en tot 30X MDW

VE = verpakkingseenheid.

Order nr.	850001011 €	850001012 €
Orig. nr.	JOFMP3V	JOFMP3V1
Verpakking	carded	doos
VE	3	10
Prijs/VE	€ 20,50	56,50



COMBINATIEFILTER A1B1E1K1. conform CE EN 14387/EN 143
-filter tegen organische, anorganische en zure gassen en dampen
evenals ammonia klasse 1 VE = verpakkingseenheid.

Order nr.	850001018 €	850001019 €
Orig. nr.	JOFILABE	JOFILABE
Verpakking	carded	doos
VE	2	8
Prijs/VE	€ 25,90	91,90



FIJNSTOFMASKER FFP1 MET VENTIEL.

-conform CE 0086 EN149:2001

-bevestiging : elastiek

-regelbare neusclip : aan de binnenkant

-met uitademingventiel

-bescherming in een vochtige omgeving tegen calciumcarbonaat-
magnesium-cement-zacht hout

-minimale bescherming tegen onschadelijke vaste-en

vloeistofdeeltjes tot 10mg/m3 en tot 4X MDW

VE = verpakkingseenheid.

Order nr.	850001006 €
Orig. nr.	JOFMP1V15
Verpakking	doos
VE	15
Prijs/VE	€ 38,50



HALFGELAATSMASKER.

- Halfgelaatsmasker in siliconenrubber voor 2 filters
- Verstelbaar ergonomisch harnas
- Speciale schroefdraad
- Geleverd zonder filters (verkrijgbaar in de accessoires)

Order nr.	850001020 €
Orig. nr.	JOHMSB
Verpakking	carton
Prijs	€ 38,50

Gehoorbescherming



Rode oorkap met abs cup.

-conform CE EN352-1

-zachte oorkussentjes in

synthetisch leder voor een

langdurig draagcomfort

-verstelbare hoofdband in 3

verschillende standen

-demping : 27db (SNR)

Order nr.	850001501 €
Orig. nr.	JOK27DB
Demping	dB (SNR) 27
Prijs	€ 7,40



Gele vouwbare oorkap met extra hoge demping.

-conform CE EN352-1

-zachte oorkussentjes in synthetisch leder voor een langdurig
draagcomfort

-verstelbare hoofdband met een zachte binnenbekleding

-demping : 30db (SNR)

Order nr.	850001502 €
Orig. nr.	JOK30DB
Demping	dB (SNR) 30
Prijs	€ 13,50



safety shoes collection



Veiligheidsschoenen



S3



Lage veiligheidsschoenen in gewaxt waterafstotend rundsnerf leder.

Kenmerken:

- veiligheidsklasse : S3
- kleur : bruin
- gewicht : 620gr
- schacht: gewaxt rundsleer met reflecterende strips
- buitenzool : dubbel densiteiten PU-zool
- binnenzool : anti-statisch, anatomisch en uitneembaar
- tussenzool : composiet
- neus : staal
- overneus : pu
- voering : air mesh-ademend en vochtabsorberend
- hielversterking "torsion control"

MADE IN EUROPE

Order nr.	Orig. nr.	Maat	Prijs €
860000438	SHNEPL38	38	73,90
860000439	SHNEPL39	39	73,90
860000440	SHNEPL40	40	73,90
860000441	SHNEPL41	41	73,90
860000442	SHNEPL42	42	73,90
860000443	SHNEPL43	43	73,90
860000444	SHNEPL44	44	73,90
860000445	SHNEPL45	45	73,90
860000446	SHNEPL46	46	73,90
860000447	SHNEPL47	47	73,90



S3



Hoge veiligheidsschoenen in gewaxt waterafstotend rundsnerf leder.

- veiligheidsklasse : S3
- kleur : bruin
- schacht: gewaxt rundsleer met reflecterende strips
- buitenzool : dubbel densiteits PU
- binnenzool : anti-statisch, anatomisch en uitneembaar
- tussenzool : staal
- neus : staal
- overneus : pu
- voering : air mesh-ademend en vochtabsorberend
- hielversterking "torsion control"

MADE IN EUROPE

Order nr.	Orig. nr.	Maat	Prijs €
860000338	SHSATM38	38	75,90
860000339	SHSATM39	39	75,90
860000340	SHSATM40	40	75,90
860000341	SHSATM41	41	75,90
860000342	SHSATM42	42	75,90
860000343	SHSATM43	43	75,90
860000344	SHSATM44	44	75,90
860000345	SHSATM45	45	75,90
860000346	SHSATM46	46	75,90
860000347	SHSATM47	47	75,90
860000348	SHSATM48	48	75,90



S3



Hoge veiligheidsschoenen in waterafstotend buff burton.

Kenmerken:

- veiligheidsklasse: S3
- kleur: zwart -gewicht: 640gr
- buitenzool: dubbele densiteit
- PU-zoolbinnenzool: anti-statisch, anatomisch, uitneembaar
- tussenzool: composiet
- neus: composiet
- voering: air mesh-ademend en vochtabsorberend

MADE IN EUROPE

Order nr.	Orig. nr.	Maat	Prijs €
860001938	SHMER38	38	49,50
860001939	SHMER39	39	49,50
860001940	SHMER40	40	49,50
860001941	SHMER41	41	49,50
860001942	SHMER42	42	49,50
860001943	SHMER43	43	49,50
860001944	SHMER44	44	49,50
860001945	SHMER45	45	49,50
860001946	SHMER46	46	49,50
860001947	SHMER47	47	49,50



S3



Lage veiligheidsschoenen in waterafstotend buff burton.

Kenmerken:

- veiligheidsklasse: S3
- kleur: zwart
- gewicht: 640gr
- buitenzool: dubbele densiteit
- PU-zoolbinnenzool: anti-statisch, anatomisch, uitneembaar
- tussenzool: composiet -neus: composiet
- voering: air mesh-ademend en vochtabsorberend

MADE IN EUROPE

Order nr.	Orig. nr.	Maat	Prijs €
860001838	SHGIOL38	38	47,50
860001839	SHGIOL39	39	47,50
860001840	SHGIOL40	40	47,50
860001841	SHGIOL41	41	47,50
860001842	SHGIOL42	42	47,50
860001843	SHGIOL43	43	47,50
860001844	SHGIOL44	44	47,50
860001845	SHGIOL45	45	47,50
860001846	SHGIOL46	46	47,50
860001847	SHGIOL47	47	47,50

Wat is RPU?

RPU is een technologie voor het printen van polyurethaan ontwikkeld en gebreveteerd door Stemma Srl. Deze innovatieve technologie laat het toe om zolen te fabriceren met een zeer lage dichtheid, zonder enige vorm van gebreken, zoals die normaal wel aanwezig zijn bij PU oppervlaktes. Hierdoor is een hoge definitie mogelijk tot in de kleinste details.

Waarom kiezen voor RPU ?

- Schacht met RPU: laat toe om inserts en verstevigingen aan te brengen zonder stikken. Is dus zeer slijtvast, maar behoudt zijn lichtheid en flexibiliteit.
- Zool full RPU: zorgt voor een zeer goede grip op elke ondergrond in elke omstandigheid. Zeer licht, met uitstekende schokdempingscapaciteiten. Er is ook heel weinig slijtage van de zool, slechts 13% na 1 miljoen stappen.



Hoge veiligheidsschoen in hoogwaardig waterafstotend randsnurf leder.

MADE IN EUROPE

Kenmerken:

- veiligheidsklasse : S3
- kleur : zwart
- schacht: vol nerfleder Burton
- buitenzool : dubbel densiteiten PU-zool
- binnenzool : anti-statisch en uitneembaar
- tussenzool : staal
- neus : staal
- overneus : pu

Order nr.	Orig. nr.	Maat	Prijs €
860000038	SHPOL38	38	37,90
860000039	SHPOL39	39	37,90
860000040	SHPOL40	40	37,90
860000041	SHPOL41	41	37,90
860000042	SHPOL42	42	37,90
860000043	SHPOL43	43	37,90
860000044	SHPOL44	44	37,90
860000045	SHPOL45	45	37,90
860000046	SHPOL46	46	37,90
860000047	SHPOL47	47	37,90



Lage sportieve veiligheidsschoen met RPU technologie

MADE IN EUROPE

Kenmerken:

- veiligheidsklasse : S3
- kleur : zwart/rood/grijs
- schacht : microvezel + RPU
- buitenzool : RPU polyurethaan
- binnenzool : antistatisch, uitneembaar
- tussenzool : composiet
- neus : aluminium
- voering : synthetisch

Order nr.	Orig. nr.	Maat	Prijs €
860002438	SHPRINCELS338	38	94,90
860002439	SHPRINCELS339	39	94,90
860002440	SHPRINCELS340	40	94,90
860002441	SHPRINCELS341	41	94,90
860002442	SHPRINCELS342	42	94,90
860002443	SHPRINCELS343	43	94,90
860002444	SHPRINCELS344	44	94,90
860002445	SHPRINCELS345	45	94,90
860002446	SHPRINCELS346	46	94,90
860002447	SHPRINCELS347	47	94,90



Lage veiligheidsschoen met RPU technologie S1P

MADE IN EUROPE

Kenmerken:

- veiligheidsklasse : S1P
- kleur : grijs/blauw
- schacht : mesh + RPU
- buitenzool : RPU polyurethaan
- binnenzool : antistatisch, uitneembaar
- tussenzool : composiet
- neus : aluminium
- voering : synthetisch

Order nr.	Orig. nr.	Maat	Prijs €
860002338	SHPRINCES1P38	38	90,50
860002339	SHPRINCES1P39	39	90,50
860002340	SHPRINCES1P40	40	90,50
860002341	SHPRINCES1P41	41	90,50
860002342	SHPRINCES1P42	42	90,50
860002343	SHPRINCES1P43	38	90,50
860002344	SHPRINCES1P44	44	90,50
860002345	SHPRINCES1P45	45	90,50
860002346	SHPRINCES1P46	46	90,50
860002347	SHPRINCES1P47	47	90,50



Hoge sportieve veiligheidsschoen met RPU technologie

MADE IN EUROPE

Kenmerken:

- veiligheidsklasse: S3
- kleur: zwart/rood/grijs
- schacht: microvezel + RPU
- buitenzool: RPU polyurethaan
- binnenzool: antistatisch, uitneembaar
- tussenzool: composiet
- neus: aluminium
- voering: synthetisch

Order nr.	Orig. nr.	Maat	Prijs €
860002538	SHPRINCESMS338	38	99,50
860002539	SHPRINCESMS339	39	99,50
860002540	SHPRINCESMS340	40	99,50
860002541	SHPRINCESMS341	41	99,50
860002542	SHPRINCESMS342	42	99,50
860002543	SHPRINCESMS343	43	99,50
860002544	SHPRINCESMS344	44	99,50
860002545	SHPRINCESMS345	45	99,50
860002546	SHPRINCESMS346	46	99,50
860002547	SHPRINCESMS347	47	99,50



S3



Lage veiligheidsschoen in leder



Kenmerken:

- veiligheidsklasse: S3
- kleur: zwart
- schacht: leder
- buitenzool: Nitril rubber/EVA
- binnenzool: anti-statisch, anatomisch
- tussenzool: composiet
- neus: composiet

Voordelen:

- zool resistent aan temperaturen tot 300 °C
- resistent tegen olie en zuren

Order nr.	Orig. nr.	Maat	Prijs €
860002738	SHAVANTL38	38	95,90
860002739	SHAVANTL39	39	95,90
860002740	SHAVANTL40	40	95,90
860002741	SHAVANTL41	41	95,90
860002742	SHAVANTL42	42	95,90
860002743	SHAVANTL43	43	95,90
860002744	SHAVANTL44	44	95,90
860002745	SHAVANTL45	45	95,90
860002746	SHAVANTL46	46	95,90



S3



Hoge veiligheidsschoen in leder



Kenmerken:

- veiligheidsklasse: S3
- kleur: zwart
- schacht: leder
- buitenzool: Nitril rubber/EVA
- binnenzool: anti-statisch, anatomisch
- tussenzool: composiet
- neus: composiet

Voordelen:

- zool resistent aan temperaturen tot 300 °C
- resistent tegen olie en zuren

Order nr.	Orig. nr.	Maat	Prijs €
860002638	SHAVANTM38	38	98,50
860002639	SHAVANTM39	39	98,50
860002640	SHAVANTM40	40	98,50
860002641	SHAVANTM41	41	98,50
860002642	SHAVANTM42	42	98,50
860002643	SHAVANTM43	43	98,50
860002644	SHAVANTM44	44	98,50
860002645	SHAVANTM45	45	98,50
860002646	SHAVANTM46	46	98,50



S3



Lage veiligheidsschoen in leder



Kenmerken:

- veiligheidsklasse: S3
- kleur: bruin/geel
- schacht: leder
- buitenzool: Nitril rubber/EVA
- binnenzool: anti-statisch, anatomisch
- tussenzool: composiet
- neus: composiet

Voordelen:

- zool resistent aan temperaturen tot 300 °C
- resistent tegen olie en zuren

Order nr.	Orig. nr.	Maat	Prijs €
860002938	SHTORNADO38	38	97,50
860002939	SHTORNADO39	39	97,50
860002940	SHTORNADO40	40	97,50
860002941	SHTORNADO41	41	97,50
860002942	SHTORNADO42	42	97,50
860002943	SHTORNADO43	43	97,50
860002944	SHTORNADO44	44	97,50
860002945	SHTORNADO45	45	97,50
860002946	SHTORNADO46	46	97,50
860002947	SHTORNADO47	47	97,50



S3



Hoge veiligheidsschoen in leder



Kenmerken:

- veiligheidsklasse: S3
- kleur: bruin/geel
- schacht: leder
- buitenzool: Nitril rubber/EVA
- binnenzool: anti-statisch, anatomisch
- tussenzool: composiet
- neus: composiet

Voordelen:

- zool resistent aan temperaturen tot 300 °C
- resistent tegen olie en zuren

Order nr.	Orig. nr.	Maat	Prijs €
860002838	SHCICLONE38	38	100,00
860002839	SHCICLONE39	39	100,00
860002840	SHCICLONE40	40	100,00
860002841	SHCICLONE41	41	100,00
860002842	SHCICLONE42	42	100,00
860002843	SHCICLONE43	43	100,00
860002844	SHCICLONE44	44	100,00
860002845	SHCICLONE45	45	100,00
860002846	SHCICLONE46	46	100,00
860002847	SHCICLONE47	47	100,00

Car



S3



MADE IN EUROPE

Hoge **lasschoen** in hoogwaardig waterafstotend rundsnerf leder.

Kenmerken:

- veiligheidsklasse : S3
- kleur : zwart
- schacht : vol Burton rundsnerfleider
- buitenzool : PU met dubbele densiteit
- binnenzool : uitneembaar en anti-statisch
- tussenzool : staal
- neus : staal
- overneus : PU
- met lasbescherming

Order nr.	Orig. nr.	Maat	Prijs €
860002138	SHPOL6438	38	54,50
860002139	SHPOL6439	39	54,50
860002140	SHPOL6440	40	54,50
860002141	SHPOL6441	41	54,50
860002142	SHPOL6442	42	54,50
860002143	SHPOL6443	43	54,50
860002144	SHPOL6444	44	54,50
860002145	SHPOL6445	45	54,50
860002146	SHPOL6446	46	54,50
860002147	SHPOL6447	47	54,50
860002148	SHPOL6448	48	54,50

Car



S3



MADE IN EUROPE

Laslaars in waterafstotend rundsnerf leder.

Kenmerken:

- veiligheidsklasse : S3
- kleur : bruin
- schacht : rundsnerf leder
- buitenzool : PU/rubber
- binnenzool : antistatisch , anatomisch
- tussenzool : staal
- neus : staal
- overneus : rubber
- met lasbescherming

Order nr.	Orig. nr.	Maat	Prijs €
860002239	SHATL1139	39	102,00
860002240	SHATL1140	40	102,00
860002241	SHATL1141	41	102,00
860002242	SHATL1142	42	102,00
860002243	SHATL1143	43	102,00
860002244	SHATL1144	44	102,00
860002245	SHATL1145	45	102,00
860002246	SHATL1146	46	102,00
860002247	SHATL1147	47	102,00

Car



S2



MADE IN EUROPE

Lage veiligheidsschoen in waterafstotend en ademendmicrovezel.

Kenmerken:

- veiligheidsklasse : S2
- kleur : wit
- gewicht : 450gr
- schacht : waterafstotend en ademend microvezel
- buitenzool : enkel densiteiten PU-zool
- binnenzool : anti-statisch en uitneembaar
- neus : staal

Order nr.	Orig. nr.	Maat	Prijs €
860001035	SHARW35	35	40,50
860001036	SHARW36	36	40,50
860001037	SHARW37	37	40,50
860001038	SHARW38	38	40,50
860001039	SHARW39	39	40,50
860001040	SHARW40	40	40,50
860001041	SHARW41	41	40,50
860001042	SHARW42	42	40,50
860001043	SHARW43	43	40,50
860001044	SHARW44	44	40,50
860001045	SHARW45	45	40,50
860001046	SHARW46	46	40,50
860001047	SHARW47	47	40,50
860001048	SHARW48	48	40,50

Car



S2



Lage veiligheidsschoen in waterafstotend en ademend microvezel.

Kenmerken:

- veiligheidsklasse : S2
- kleur : zwart
- gewicht : 450gr
- schacht : waterafstotend en ademend microvezel
- buitenzool : enkel densiteiten PU-zool
- binnenzool : anti-statisch en uitneembaar
- neus : staal

Order nr.	Orig. nr.	Maat	Prijs €
860001135	SHARB35	35	40,50
860001136	SHARB36	36	40,50
860001137	SHARB37	37	40,50
860001138	SHARB38	38	40,50
860001139	SHARB39	39	40,50
860001140	SHARB40	40	40,50
860001141	SHARB41	41	40,50
860001142	SHARB42	42	40,50
860001143	SHARB43	43	40,50
860001144	SHARB44	44	40,50
860001145	SHARB45	45	40,50
860001146	SHARB46	46	40,50
860001147	SHARB47	47	40,50
860001148	SHARB48	48	40,50

EQUIPMENT

Steekwagens



Stalen steekwagen.

Kenmerken:

- Gelaste stalen buisconstructie
- Op PU banden diam. 260 mm.

Order nr.	758621250 €	
Orig. nr.	SHC01250	
Capaciteit	kg	250
Afmetingen tafel	mm	400x180
Afmetingen buizen	mm	25x1,5
Diameter banden	mm	260
Materie	staal	
Gewicht	kg	10,50
Afmetingen (l x b x h)	mm	500 x 470 x 1150
Prijs	€	59,90



Stalen steekwagen TYPE HIGH.

Kenmerken:

- Gelaste stalen buisconstructie.
- Op slijtvaste en geluiddempende polyurethaanwielen diam. 260 mm op rollagers

Order nr.	758624250 €	
Orig. nr.	SHC04250	
Capaciteit	kg	250
Afmetingen tafel	mm	270x200
Afmetingen buizen	mm	25x1,5
Diameter banden	mm	260
Materie	staal	
Gewicht	kg	14,00
Afmetingen (l x b x h)	mm	450 x 500 x 1160
Prijs	€	73,90



Aluminium steekwagen.

Kenmerken:

- Gelaste aluminium buisconstructie
- Op PU banden diam. 260 mm.

Order nr.	758621255 €	
Orig. nr.	SHC01250A	
Capaciteit	kg	250
Afmetingen tafel	mm	400x200
Afmetingen buizen	mm	25x1,5
Diameter banden	mm	260
Materie	alu	
Gewicht	kg	6,20
Afmetingen (l x b x h)	mm	500 x 470 x 1150
Prijs	€	102,00



Aluminium steekwagen TYPE HIGH.

Kenmerken:

- Gelaste aluminium buisconstructie.
- Op slijtvaste en geluiddempende polyurethaanwielen diam. 260 mm op rollagers

Order nr.	758624255 €	
Orig. nr.	SHC04250A	
Capaciteit	kg	250
Afmetingen tafel	mm	270x200
Afmetingen buizen	mm	25x1,5
Diameter banden	mm	260
Materie	alu	
Gewicht	kg	7,60
Afmetingen (l x b x h)	mm	450 x 500 x 1160
Prijs	€	111,00



Steekwagen TYPE BIG BOX.

Kenmerken:

- Gelaste stalen buisconstructie.
- Op slijtvaste en geluiddempende polyurethaan-wielen diam. 260 mm op rollagers.
- Met neerklapbare lange voet om groot-volume lasten te kunnen vervoeren bvb. witgoed.

Order nr.	758622612 €	
Orig. nr.	SHCA260	
Capaciteit	kg	150
Afmetingen tafel	mm	400x500
Afmetingen buizen	mm	25x1,5
Diameter banden	mm	260
Materie	staal	
Gewicht	kg	10,00
Afmetingen (l x b x h)	mm	540 x 600 x 1250
Prijs	€	121,00



Zware steekwagen TYPE GASFLES.

Kenmerken:

- Gelaste stalen buisconstructie.
- Op polyurethaan-wielen diam. 260 mm op rollagers.
- Met opbergvak.
- Voor het transport van 2 standaard gasflessen.

Order nr.	758625610 €	
Orig. nr.	SHC561	
Capaciteit	kg	200
Afmetingen tafel	mm	490x250
Afmetingen buizen	mm	25x2
Diameter banden	mm	260
Materie	staal	
Gewicht	kg	18,50
Afmetingen (l x b x h)	mm	700 x 680 x 1100
Prijs	€	131,00



Steekwagen TYPE BIG BOX TRAP

Kenmerken:

- Gelaste stalen buisconstructie
- Op 2x3 volle rubberwielen diam. 150 mm
- Geschikt voor het transporteren op trappen
- Neerklapbare voet om groot-volume te kunnen vervoeren

Order nr.	758624151 €	
Orig. nr.	SHC410	
Capaciteit	kg	200
Afmetingen tafel	mm	400x500
Afmetingen buizen	mm	25x1,5
Diameter banden	mm	150
Materie	staal	
Gewicht	kg	17,50
Afmetingen (l x b x h)	mm	540 x 600 x 1250
Prijs	€	136,00



Steekwagen TYPE HEAVY DUTY.

Kenmerken:

- Gelaste stalen buisconstructie.
- Op volle rubberwielen diam. 200mm.

Order nr.	758625612 €	
Orig. nr.	SHC530	
Capaciteit	kg	300
Afmetingen tafel	mm	390x210
Afmetingen buizen	mm	25x1,5
Diameter banden	mm	200
Materie	staal	
Gewicht	kg	15,80
Afmetingen (l x b x h)	mm	550 x 660 x 1130
Prijs	€	76,50

EQUIPMENT

TOOLS



NEW

Inklapbare steekwagen 128kg in aluminium.

Order nr.	758629901 €	
Orig. nr.	SHC200A	
Capaciteit	kg	128
Gewicht	kg	5,30
Afmetingen (l x b x h)	mm	1080 x 490 x 515
Prijs	€	81,50

Platformwagens

TOOLS



Platformwagen met laadblad in geperste staalplaat en kunststof antislip beschermingslaag.

Kenmerken:

- Zacht-vinyl beschermingsboord rondom het laadplatform
- 2 vaste en 2 draaibare harde rubber wielen
- Neerklapbare hendel voor een compact opbergen van de platformwagen.

Order nr.	758621500 €	758623000 €
Orig. nr.	SHC150	SHC300
Capaciteit	kg	300
Diameter banden	mm	125
Afmetingen laadvlak	mm	740x480
Hoogte	mm	840
Gewicht	kg	13,40
Prijs	€	77,50

TOOLS



Platformwagen met een kunststof laadblad.

Kenmerken:

- Heel licht en supersterk
- 2 vaste en 2 draaibare wielen
- Grote, geruisloze PU wielen
- Neerklapbare hendel voor een compact opbergen van de platformwagen.

Order nr.	758621240 €	
Orig. nr.	SHC400K	
Capaciteit	kg	300
Diameter banden	mm	125
Afmetingen laadvlak	mm	910x600
Gewicht	kg	20,00
Prijs	€	110,00

Transpalletwagens

Unicraft



Professionele transpallet 2,5 ton. Sterke constructie voor veeleisend, dagelijks gebruik.

Kenmerken

- Volhydraulische hef- en daalinrichting
- Pomp met hardverchromde zuiger
- Overdrukventiel
- Hendel met 3 functies via een hendel (heffen, neutraal, dalen)
- Het bereiken van de maximale hoogte in slechts 10 slagen.
- Zeer wendbaar door een hoge draailag tot 210°
- Precisie-rollagers in alle wielen van de pompwagens

Voordelen

- Zeer soepel, wendbaar en licht in bediening.
- Daalsnelheid traploos regelbaar via een fijnvoelig aflaatventiel.
- Gemakkelijk verrijdbaar door extra lichte aluminiumwielen met rubber en tandem vorkwielen in PU
- Frame en vorken palletwagen zeer stabiel.
- Met extra voetpedaal voor dalen.
- Ergonomische bedienhendel met rubber handvat.
- Onderhoudsvrij

Order nr.	716152506 €	
Orig. nr.	PHW2506	
Capaciteit	t	2,5
Breedte vork	mm	160
Totale breedte	mm	540
Minimum vorkhoogte	mm	85
Maximum vorkhoogte	mm	200
Hefhoogte	mm	115
Totale lengte	mm	1543
Lengte vorken	mm	1150
Topwielen	mm	2x1
Breedte vorken - overmeten	mm	540
Breedte vorken - tussenuimte	mm	200
Gewicht	kg	69,00
Afmetingen (l x b x h)	mm	1543 x 520 x 1214
Prijs	€	345,00

TOOLS



LAGE UITVOERING

60mm

Transpalletwagen EXTRA LAAG MODEL

Voor wie geregeld lagere niet-standaard palletten dient te vervoeren. Capaciteit 2,5T.

Kenmerken:

- Vorken zijn 20mm lager dan bij een normale transpallet.
- Industriële kwaliteit.
- Pomp met kwaliteits-hydrauliek.
- Euro-pallet type.
- Enkelvoudige topwielen.
- Veiligheidshandvat met 3 functie-posities.
- Voorzien van smeerpunten.

Order nr.	758702551 €	
Orig. nr.	TPCBY25TSL	
Capaciteit	t	2,5
Minimum vorkhoogte	mm	60
Hefhoogte	mm	148
Lengte vorken	mm	1150
Topwielen	mm	2x1
Breedte vorken - overmeters	mm	510
Breedte vorken - tussenruimte	mm	220
Gewicht	kg	130,00
Prijs	€	474,00

unicraft



KORT MODEL



800mm

Professionele korte transpallet met 2,5T hefkracht. Stabiele en robuuste kwaliteit voor dagelijks gebruik.

Kenmerken:

- Volhydraulische hef- en daalinrichting.
- Pomp met hardverchromde zuiger en overdrukventiel.
- Daalsnelheid traploos regelbaar.
- Chassis en vorken zeer stabiel.
- 3 functies via een hendel bedienbaar (heffen, dalen, neutrale positie).
- Het bereiken van de maximale hoogte in slechts 10 slagen.

Voordelen

- Zeer wendbaar door een hoge draaislag tot 210°.
- Gemakkelijk verrolbaar door extra lichte aluminiumwielen met rubber en tandem vorkwielen in PU.
- Onderhoudsvrij.
- Gebouwd volgens CE-normen.

Order nr.	716150256 €	
Orig. nr.	PHW2505K	
Capaciteit	t	2,5
Lengte extra korte vorken	mm	800
Breedte vork	mm	160
Totale breedte	mm	540
Minimum vorkhoogte	mm	85
Hefhoogte	mm	200
Totale lengte	mm	1170
Gewicht	kg	71,00
Prijs	€	569,00

EQUIPMENT



Lichte en compacte kunststof transpallet 1 ton

Kenmerken:

- Lichte en stille transpallet, geschikt voor intensief gebruik
- Ideaal in winkels en warenhuizen, waar stil en vlot werken belangrijk is.
- Bestand tegen zeer lage temperaturen zoals in vriescellen.
- Bestand tegen opspringen van agressieve vloeistoffen
- Made in Europe

Voordelen

- Roest niet, spatwaterbestendig
- Geruisloze looprollen
- Ergonomisch handvat

Order nr.	716159100 €	
Orig. nr.	PHW100K	
Capaciteit	t	1
Breedte vork	mm	155
Totale breedte	mm	520
Minimum vorkhoogte	mm	85
Hefhoogte	mm	115
Totale lengte	mm	1575
Lengte vorken	mm	1150
Topwielen	mm	60
Gewicht	kg	38,00
Afmetingen (l x b x h)	mm	1575 x 525 x 1233
Prijs	€	589,00



Gecombineerde transpalletwagen. Scharliff met capaciteit 1 ton.

Kenmerken:

- Pomp met kwaliteits-hydrauliek met hardverchroomde stang en overbelastingsventiel.
- Mechanische snelgang maakt het mogelijk om de 800mm pallethoogte in 25 bewegingen te bereiken.
- Bij het omhoogpompen zetten de 2 alu-steunen zich op grond en garanderen zo de stabiliteit.

Voordelen:

- Daalsnelheid regelbaar.
- Zeer wendbaar dankzij de draaihoek tot 210°.

Order nr.	758710001 €	
Orig. nr.	PHH1001	
Capaciteit	t	1
Breedte vork	mm	160
Totale breedte	mm	540
Minimum vorkhoogte	mm	85
Hefhoogte	mm	715
Lengte vorken	mm	1150
Chassishoogte	mm	430
Gewicht	kg	122,00
Prijs	€	865,00

Unicraft



Transpalletwagen 2 ton met weegschaal.

Kenmerken:

- Groot LCD-display met goeie leesbaarheid. Werkt op batterijen.
- Nauwkeurigheid 0,1%.
- Functies: tara-correctie, bruto/netto gewicht en sommeringsfunctie.
- Daalsnelheid met hendel regelbaar.
- Met neutrale veiligheidspositie.

Order nr.	716150262 €	
Orig. nr.	PHW2002W	
Capaciteit	t	2
Breedte vork	mm	182
Totale breedte	mm	572
Minimum vorkhoogte	mm	85
Hefhoogte	mm	115
Lengte vorken	mm	1150
Gewicht	kg	130,00
Prijs	€	1.729,00

Unicraft

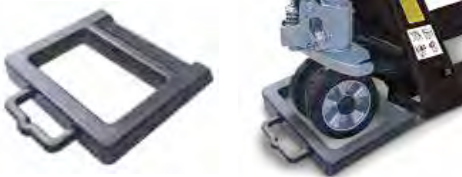

Transpallet-stopper.

Kenmerken:

- Voorkomt weggrollen van transpallets, heftrucks, ...
- Vervaardigd uit schokbestendige harde PVC, met handvat.

Geschikt voor:

- Alle types van palletwagens

Order nr.	716150001 €	
Orig. nr.	PHS1	
Gewicht	kg	1,47
Afmetingen (l x b x h)	mm	295 x 290 x 50
Prijs	€	30,50

Handstapelaars

TOOLS



Manuele stapelaar met capaciteit 1 ton en maximale werkhoogte van 1600mm.

Kenmerken:

- Quick-lift pedaal voor snel op hoogte brengen zonder last.
- Stevig en stabiel gelast stalen frame.
- Nylon loopwielen met rempedaal, garanderen een rustige loop en veilig werken.
- Dubbele loopwielen vooraan.
- Veiligheidshendel met 3 posities.
- Veiligheidsrooster beschermt de gebruiker tijdens het liften.

Geschikt voor:

- Laden en lossen van vrachtwagens, in magazijnen, etc.
- Door de compacte bouwwijze past deze stapelaar ook in deuropeningen en krappe ruimtes.

Order nr.	758701000 €	
Orig. nr.	TPSL1000	
Capaciteit	t	1
Maximum hoogte	mm	1600
Vorken	mm	61x170x1100
Minimum hoogte vorken	mm	90
Hefsnelheid	mm/s	25
Gewicht	kg	210,00
Afmetingen (l x b x h)	mm	1705 x 755 x 2080
Prijs	€	1.015,00

EQUIPMENT

Heftafels



Hydraulische heftafel 500kg

Geschikt voor:

- Handig bij montage of nazicht van kleine werkstukken.

Kenmerken:

- Stevig gelaste constructie
- op 4 stevige PU-wielen, waarvan 2 met rem
- Hoge stabiliteit door groot eigengewicht.
- Kwaliteitsvolle hydraulische voetpomp met verchroomde cilinder met PU dichtingen.
- Secuur leegloopventiel met constante daalsnelheid. Met daalbeveiliging.
- CE-conform.

Order nr.	758725050 €	
Orig. nr.	FHT500	
Capaciteit	kg	500
Afmetingen laadvlak	mm	855x550x50
Maximum hoogte	mm	900
Minimum hoogte	mm	340
Gewicht	kg	87,00
Prijs	€	483,00



NEW



Hydraulische schaarheftafel met elektrische bediening.

Altijd de meest ergonomische werkhogte.

Kenmerken:

- Capaciteit 1 of 2 ton
- Aparte stuurseenheid met 3 meter kabel, op/neer knoppen en noodstop
- Traploos instelbare hoogte
- Zeer robuuste, zware stalen frame
- Voldoet aan EN1570
- Cilinder met dubbele veiligheid

Order nr.		716154100 €	716154200 €
Orig. nr.		SHT1000	SHT2000
Capaciteit	t	1	2
Vermogen	kW	0,75	0,75
Afmetingen laadvlak	mm	1300x800	1300x800
Maximum hoogte	mm	1010	1010
Minimum hoogte	mm	190	190
Hefduur	s	25	40
Hefnelheid onder last	mm/s	40	22
Gewicht	kg	220,00	280,00
Afmetingen (l x b x h)	mm	1300 x 800 x 190	1300 x 800 x 190
Prijs	€	1.845,00	2.115,00



EQUIPMENT

Hydraulisch/pneumatische hefbrug met wielklem. Stationair model met capaciteit 700 kg.

Kenmerken:

- Voorzien van veiligheid tegen dalen.
- Bij aansluiten van de pneumatische pomp op compressor verhoogt de pompsnelheid.
- CE-conform.

Uitgerust met:

- Verbredingsset bestaande uit steunstangen en oprijplaten die zowel tafel als oprijvlak verbreden tot 1218mm.

Order nr.		758725060 €
Orig. nr.		TPSL700
Capaciteit	kg	700
Afmetingen laadvlak	mm	1995x1218
Maximum hoogte	mm	825
Minimum hoogte	mm	185
Afmetingen oprijplaat	mm	550x1218
Afmetingen pomp	mm	600x240x380
Gewicht	kg	174,00
Afmetingen (l x b x h)	mm	2060 x 870 x 210
Prijs	€	1.045,00



Ultracompacte hydraulische motorhefbrug 680kg

Kenmerken:

- Compact en tegelijk stabiel met een capaciteit tot 680kg.
- met 4 wielen, waarvan 2 draaibaar en met rem.
- Oppompen met voethendel.

Geschikt voor:

- Snel opklapbaar, dus ideaal voor kleine werkplaatsen.
- Voor het reinigen, nazien en herstellen van moto's of andere tweewielers.

Geleverd met:

- 4 meegeleverde spanbanden voor het veilig vastzetten van de voertuigen.

Order nr.	716201500 €		
Orig. nr.		MH680	
Capaciteit	kg	680	
Maximum hoogte	mm	410	
Minimum hoogte	mm	140	
Gewicht	kg	37,00	
Afmetingen (l x b x h)	mm	864 x 396 x 315	
Prijs	€	186,00	

Transportrollen



Complete transportrollenset voor het verplaatsen van zware lasten.

Ideaal voor zware machines en constructies zonder wielen.

Inhoud:

- 4 transportrollen
- 2 draaibare ronde draagplaten
- 2 hoekige draagplaten
- 2 verbindingstangen
- 2 stuurbaren
- 1 trekstang
- 1 metalen opbergkoffer met wielen en handvaten

Order nr.	716195020 €		
Orig. nr.		TR20	
Capaciteit	t	20	
Hoogte	mm	108	
Gewicht	kg	50,00	
Prijs	€	635,00	



Set transportrollen voor het vlot verhuizen van zware lasten.

Kenmerken:

- Kogelgelagerde nylonrollen, met anti-slip gummilaag bovenaan.
- 2 transportrollers per set.
- Inclusief 2 stangen van 500 mm om ze te verbinden.

Order nr.	716192060 €		716192120 €	
Orig. nr.		VTR6	VTR12	
Capaciteit	t	6	12	
Gewicht	kg	30,00	36,00	
Afmetingen (l x b x h)	mm	320 x 290 x 110	420 x 270 x 110	
Prijs	€	279,00	387,00	

Unicraft



Transportwielen stuurbaar type met hendel

Kenmerken:

- Met draaibaar plateau voor gemakkelijk verhuizen van zware lasten.
- Kogelgelagerde nylonrollen, en anti-slip gummilaagbovenaan.
- Wordt gebruikt samen met VTR-set rollen.

Order nr.	716191030	716191060	716191120
Orig. nr.	TF3	TF6	TF12
Capaciteit	t 3	6	12
Gewicht	kg 15,00	50,00	66,00
Afmetingen (l x b x h)	mm 300 x 220 x 105	640 x 530 x 115	640 x 560 x 115
Prijs	€ 166,00	397,00	478,00

Unicraft



Massieve stalen hefstang met rollen voor hoge stabiliteit.

Kenmerken:

- Voor het optillen van zware lasten of machines.
- meestal gebruikt om een krik of transportrol onder de last te kunnen plaatsen

Order nr.	716196015	716196050
Orig. nr.	HS1.5	HS5
Capaciteit	t 1,5	5
Lengte	mm 2000	2200
Gewicht	kg 16,00	32,00
Afmetingen (l x b x h)	mm 2030 x 300 x 60	2040 x 400 x 70
Prijs	€ 109,00	230,00

Unicraft



Verhuizer.

Geschikt voor:

- Het verplaatsen van voertuigen, ideaal voor krappe ruimten, garages of depots.

Kenmerken:

- Zijwaarts en ter plekke draaien mogelijk.
- Lichte behuizing.
- Geschikt voor wieldiameter vanaf 30 cm.

Order nr.	716201600
Orig. nr.	PV680
Capaciteit	kg 680
Maximum wieldiameter	mm 300
Gewicht	kg 21,50
Afmetingen (l x b x h)	mm 68 x 65 x 22
Prijs	€ 188,00

Unicraft



Transporthoekrollen voor het verhuizen van kasten en hoekige meubels.

Kenmerken:

- Geleverd per set van 4 hoeken.

Order nr.	716197150
Orig. nr.	ETR4/150
Capaciteit	kg 150
Gewicht	kg 8,00
Afmetingen (l x b x h)	mm 255 x 255 x 85
Prijs	€ 155,00

EQUIPMENT



Universele mobiele basis voor het verplaatsen van machines.

Kenmerken:

- 360° draaibare wielen met rem.
- Capaciteit 230 kg.

Voordelen:

- Gemakkelijk opkrikken en verrijden.
- Eenvoudig aanpasbaar.

Order nr.	716150230 €		
Orig. nr.		UF230	
Minimum grootte vierkant	mm	280x280	
Maximum grootte vierkant	mm	890x890	
Minimum grootte rechthoekig	mm	430x280	
Maximum grootte rechthoekig	mm	1290x480	
Afstand tussen openingen	mm	25	
Capaciteit	kg	230	
Materie		staal	
Gewicht	kg	7,62	
Prijs	€	95,50	



Hefrollerset 1 ton.

Kenmerken:

- Set van 2 hefrollers met hefstang.
- voorzien van lage hijslip, die u onder de laagste lasten kan schuiven
- Capaciteit 1 ton per set.
- Verzinks stalen frame met gummi beschermlaag en krasvrije PU wielen.

Geschikt voor:

- Het verplaatsen van zware lasten, dozen, ramen, kaders, kasten, kisten, enz.

Order nr.	716191000 €		
Orig. nr.		HR1000	
Capaciteit	kg	1000	
Gewicht	kg	10,00	
Prijs	€	142,00	



Hydraulische machinekriks.

Geschikt voor:

- Het veilig heffen en ondersteunen van diverse lasten.
- Lage minimumhoogte ideaal voor kisten, machines,...

Kenmerken:

- 360° draaibare pompeenheid voor gemakkelijk positioneren (HMH 5 / HMH 10).
- Met wielbasis (HMH 25).
- Hendel afneembaar.
- Stabiele gelaste constructie voor zware belasting.

Order nr.	716190050	716190100	716190250	
	€	€	€	
Orig. nr.	HMH5	HMH10	HMH25	
Capaciteit	t	5	10	25
Hoogte minimum	mm	25	30	58
Hefhoogte	mm	205	230	215
Gewicht	kg	25,00	35,00	102,00
Afmetingen	mm	360 x 190	380 x 220	530 x 350
(l x b x h)		x 430	x 510	x 610
Prijs	€	329,00	403,00	1.389,00



Machinekriks met hoge capaciteit voor het optillen van machines, kratten, werkstukken ...

Kenmerken:

- Stabiele en compacte kriks voor het veilig heffen en ondersteunen van diverse lasten.
- Lage minimumhoogte, direct plaatsbaar onder de last.
- Stabiele gelaste constructie voor zware belasting.
- Daalsnelheid via aflaatschroef traploos instelbaar.
- Voet in hoogte verstelbaar (MH3/ MH8/ MH20).
- Met wielbasis (MH20).

Order nr.	Orig. nr.	Capaciteit	Hoogte minimum	Hefhoogte	Gewicht	Prijs
		t	mm	mm	kg	€
716190003	MH3	3	15	140	21,50	252,00
716190008	MH8	8	20	140	28,00	334,00
716190010	MH10	10	35	160	25,00	276,00
716190020	MH20	20	40	140	68,00	699,00

OPRIJPLATEN

p. 376



Rubberen wielkeg voor auto. Met draaggreep.

Order nr.	758136610
Orig. nr.	CARSTOP
Gewicht	kg 17,00
Afmetingen (l x b x h)	mm 175 x 100 x 145
Prijs	€ 20,50



NEW

Paar stalen oprijbokken voor inspectie aan auto's en voertuigen in alle veiligheid.

Zeer stabiele uitvoering in gelast buisstaal.

Order nr.	716202001
Orig. nr.	KR2001
Capaciteit per paar	kg 2000
Gewicht per bok	kg 7,9
Gewicht	kg 15,80
Afmetingen (l x b x h)	mm 910 x 360 x 270
Prijs	€ 89,50



NEW

Paar kunststof oprijbokken voor inspectie aan auto's en voertuigen in alle veiligheid.

Zeer stabiele rotatiegegoten kunststof bokken.
Stapelbaar en plaatsbesparend.

Order nr.	716202005
Orig. nr.	KR2500
Capaciteit per paar	kg 2500
Gewicht per bok	kg 4
Gewicht	kg 8,00
Afmetingen (l x b x h)	mm 900 x 295 x 220
Prijs	€ 99,50



HOE KIES JE EEN OPRIJPLAAT?

Capaciteit = Gewicht voertuig (in stilstand) x veiligheidscapaciteit (15-30%)

vb. 1700 kg = 1300kg x 1,3

Tips:

- Starten/stoppen zorgt voor extra gewicht, hou dus rekening met een veiligheidsmarge (15-30%).
- Grotere overcapaciteit = langere levensduur van de plaat.
- Hou rekening met de opgegeven wielbasis en -breedte van het voertuig.
- Plooibare oprijplaten beschikken over beperkte capaciteit.
- De laadcapaciteit van de plaat mag nooit overschreden worden.

Lenkte = Hoogteverschil / helling% x 100

vb. 3m = 0,9m / 30 x 100

Tip:

- Voor uw veiligheid: hellings% mag nooit 30% (= 16,5°) overschrijden

Keuze van de kop (types VAM)

De oprijplaten kunnen optioneel voorzien worden van andere koppen dan de standaardkop.



standaardkop



kop met haak



kop met buis



kop met onderhaak

Keuze van het oppervlak (types VAM)

De oprijplaten kunnen optioneel voorzien worden van rubberstrips (sommige modellen).

Dit is vereist voor voertuigen met stalen rupsen of op rollen. Voorzie 15% extra veiligheidscapaciteit.

Oprijplaten

TOOLS

TRANSPORTROLLEN

p. 373



PLOOIBAAR



Set van 2 aluminium anti-slip oprijplaten met dwarsbuis-structuur.

Kenmerken:

- Capaciteit 2x330kg.
- Breeksterkte = capaciteit x 1,5.
- Superlicht en sterk.
- Opplooibaar in het midden.
- Met anti-terugslagbeugel.

Geschikt voor:

- Voertuigen met grote banden zoals quads, grasmaaiers enz.

Order nr.	Orig. nr.	Capaciteit kg	Lengte mm	Cap./paar wielbasis 1250mm kg	Breedte mm	Aantal	Gewicht kg	Prijs €
754752500	VAP2250	330	2250	330	282	2	4,50	201,00

TOOLS



PLOOIBAAR

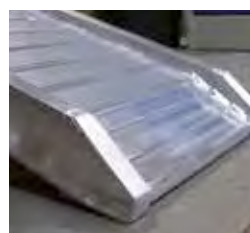

Aluminium oprijplaat 200kg

scharnierend in het midden**Kenmerken:**

- Vlak oppervlak met anti-slip profiel.
- Afgeschuinde kop om gemakkelijk op te rijden.
- Breeksterkte = capaciteit x 1,5.
- Licht en zeer compact (scharnierend)

Geschikt voor:

- kruiwagens, steekkarretjes
- tot 200kg.

Geleverd met:

- Veiligheidspal tegen het wegslijpen.

Order nr.	754751810		
Orig. nr.	VAP1810		
Capaciteit	kg	200	
Lengte	mm	2000	
Breedte zijprofiel	mm	294	
Interne breedte (B)	mm	250	
Interne breedte	mm	250	
Aantal		1	
Gewicht	kg	8,00	
Prijs	€	137,00	

EQUIPMENT



PLOOIBAAR



Aluminium oprijplaat 400kg brede uitvoering.
Scharnierend in het midden.

Kenmerken:

- Vlak oppervlak met anti-slip profiel.
- Afgeschuinde kop om gemakkelijk op te rijden.
- Breeksterkte = capaciteit x 1,5.
- Licht en zeer compact (scharnierend)

Geschikt voor:

- kruiwagens, karren, steekkarretjes
- tot 400kg.

Geleverd met:

- Veiligheidspal tegen het wegslijpen.
- VAP1910 met draagbeugels.
- VAP2000 en 2010 zonder draagbeugels.

EQUIPMENT

Order nr.		754751910 €	754752000 €	754752010 €
Orig. nr.		VAP1910	VAP2000	VAP2010
Capaciteit	kg	400	400	400
Lengte	mm	2000	2000	2000
Breedte zijprofiel	mm	651	851	1051
Interne breedte	mm	600	800	1000
Aantal		1	1	1
Gewicht	kg	21,00	27,00	32,00
Prijs	€	360,00	429,00	519,00

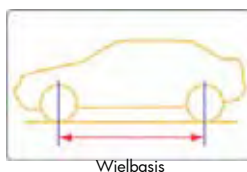
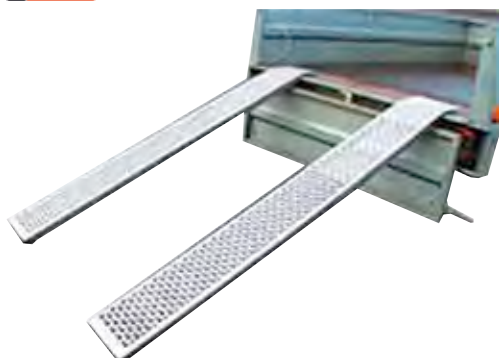

Set vaste oprijplaten met capaciteit 750kg.

Kenmerken:

- Met antislip alu oppervlak.
- Geleverd per paar. Gewicht afgebeeld per paar.
- CE-conform en met handleiding.

Geschikt voor:

- Met 2,5 of 3 meter zijn deze heel geschikt om grotere hoogtes te overbruggen.

Order nr.	Orig. nr.	Lengte mm	Cap./paar wielbasis 2000mm kg	Breedte mm	Aantal	Gewicht kg	Afmetingen (l x b x h) mm	Prijs €
754752019 €	VAM2500-260	2500	1000	260	2	21,00	2000 x 260 x 96	473,00
754752020 €	VAM3000-260	3000	1000	260	2	21,00	3000 x 260 x 95	699,00

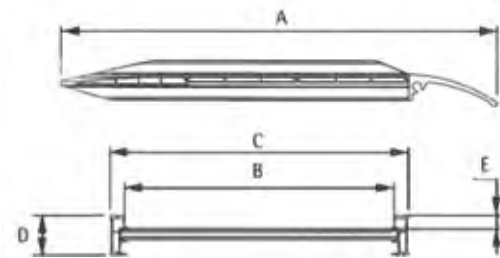

Aluminium oprijplaat 1 ton

Kenmerken

- 1 oprijplaat
- Lengte 1,8 tot 5 meter
- zware uitvoering 1 ton
- brede uitvoering tot 1000mm

Geleverd met:

- Standaardkop en veiligheid tegen het wegslaan tijdens het gebruik.
- Afwijkende afmetingen zijn op bestelling leverbaar.

Order nr.	Orig. nr.	Cap./paar wiel-basis 2000mm	Lengte (A)	Interne breedte (B)	Externe breedte (C)	Profiel hoogte (D)	Hoogte rand (E)	Aantal	Gewicht	Prijs
		kg	mm	mm	mm	mm	mm		kg	€
754752956	VAMPC18007501000	1000	1800	690	750	23	23	1	23,00	699,00
754752957	VAMPC20007501000	1000	2000	690	750	23	23	1	25,00	729,00
754752958	VAMPC24007501000	1000	2400	690	750	23	23	1	30,00	775,00
754752959	VAMPC26007501000	1000	2600	690	750	23	23	1	32,00	855,00
754752960	VAMPC30007501000	1000	3000	690	750	23	23	1	37,00	915,00
754752961	VAMPC36007501000	1000	3600	690	750	36	36	1	44,00	1.049,00
754752962	VAMPC180010001000	1000	1800	940	1000	23	23	1	34,00	815,00
754752963	VAMPC200010001000	1000	2000	940	1000	23	23	1	37,00	835,00
754752964	VAMPC240010001000	1000	2400	940	1000	23	23	1	45,00	875,00
754752965	VAMPC260010001000	1000	2600	940	1000	23	23	1	48,00	999,00
754752966	VAMPC300010001000	1000	3000	940	1000	23	23	1	55,00	1.069,00
754752967	VAMPC360010001000	1000	3600	940	1000	36	36	1	66,00	1.185,00
754752968	VAMPC400010001000	1000	4000	940	1000	36	36	1	78,00	1.289,00
754752969	VAMPC440010001000	1000	4400	940	1000	36	36	1	88,00	1.399,00
754752970	VAMPC500010001000	1000	5000	940	1000	32	32	1	99,00	1.585,00

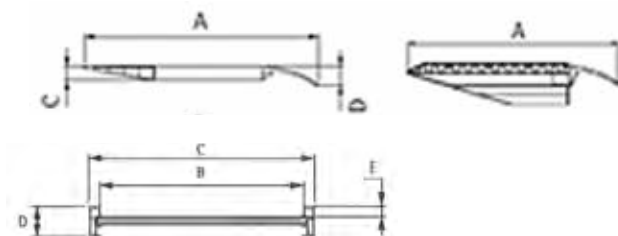

KORT

Set korte oprijplaten met hoge draagcapaciteit.

Geschikt voor:

- Het binnenrijden van containers,
- Lage drempels aan poorten, etc.

Kenmerken:

- Geleverd per paar.
- Lengte 0.5 tot 2 meter
- CE conform en met handleiding.
- Gewicht afgebeeld per paar.

Order nr.	Orig. nr.	Cap./paar wielbasis 2000mm kg	Hoogte rand (C) mm	Profiel hoogte (D) mm	Lengte (A) mm	Breedte (B) mm	Minimum laadhoogte mm	Aan- taal	Gewicht kg	Prijs €
754752021	VAM040B2/05SHF	1250	40	55	500	215	120	2	6,00	312,00
754752022	VAM040B2/08SHF	1250	40	55	800	215	160	2	8,00	323,00
754752023	VAM040B3/05SHF	2000	40	55	500	315	120	2	8,00	323,00
754752024	VAM040B3/08SHF	2000	40	55	800	315	160	2	12,00	367,00
754752025	VAM080/05SH	3000	80	80	506	300	120	2	10,00	410,00
754752026	VAM080/08SH	3000	80	80	810	300	160	2	13,00	453,00
754752027	VAM140/10SH	7500	140	140	1000	500	170	2	34,00	769,00
754752028	VAM150/12SH	7500	150	150	1256	500	220	2	41,00	845,00
754752029	VAM150/15SH	7500	150	150	1500	500	270	2	48,00	925,00
754752030	VAM150/17SH	7500	150	150	1760	500	320	2	56,00	1.019,00
754752031	VAM165/20SH	7500	165	165	2000	500	370	2	69,00	1.095,00

BESTSELLER

BESTSELLER

BESTSELLER

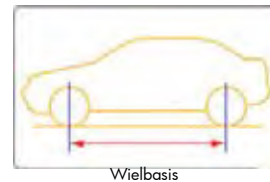
Set aluminium oprijplaten. Flex platen.

Kenmerken:

- Verschillende koppen en veiligheidsopties zijn leverbaar (zie optietabel).
- Afwijkende afmetingen zijn op bestelling leverbaar.
- Gewicht afgebeeld per paar.

Geleverd met:

- Standaardkop en aluminium veiligheidshaak tegen het wegslaan tijdens het gebruik.

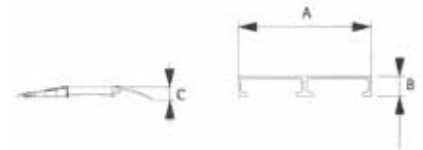

Order nr.	Orig. nr.	Lengte	Cap./paar wielbasis 1000mm	Externe breedte (A)	Profiel hoogte (B)	Hoogte (C)	Aantal	Gewicht	Prijs
		mm	kg	mm	mm	mm		kg	€
754752610	VAM030B2/15	1500	1580	215	30	55	2	13,00	377,00
754752611	VAM030B2/20	2000	830	215	30	55	2	16,00	420,00
754752612	VAM030B2/25	2500	553	215	30	55	2	19,00	442,00
754752613	VAM030B2/30	3000	394	215	30	55	2	23,00	555,00
754752614	VAM030B2/35	3500	298	215	30	55	2	26,00	609,00
754752615	VAM030B2/40	4000	235	215	30	55	2	29,00	639,00
754752616	VAM030B2/15/2	1500	2900	415	30	55	2	24,00	565,00
754752617	VAM030B2/20/2	2000	1660	415	30	55	2	30,00	629,00
754752618	VAM030B2/25/2	2500	1106	415	30	55	2	37,00	709,00
754752619	VAM030B2/30/2	3000	788	415	30	55	2	44,00	835,00
754752620	VAM030B2/35/2	3500	597	415	30	55	2	50,00	865,00
754752621	VAM030B2/40/2	4000	470	415	30	55	2	57,00	935,00
754752622	VAM030B3/15	1500	2355	315	30	55	2	18,00	432,00
754752623	VAM030B3/20	2000	1178	315	30	55	2	23,00	475,00
754752624	VAM030B3/25	2500	785	315	30	55	2	28,00	545,00
754752625	VAM030B3/30	3000	559	315	30	55	2	33,00	649,00
754752626	VAM030B3/35	3500	423	315	30	55	2	38,00	719,00
754752627	VAM030B3/40	4000	334	315	30	55	2	43,00	759,00
754752628	VAM030B3/15/2	1500	2900	615	30	55	2	35,00	669,00
754752629	VAM030B3/20/2	2000	2356	615	30	55	2	45,00	769,00
754752630	VAM030B3/25/2	2500	1570	615	30	55	2	55,00	835,00
754752631	VAM030B3/30/2	3000	1119	615	30	55	2	65,00	975,00
754752632	VAM030B3/35/2	3500	847	615	30	55	2	75,00	1.085,00
754752633	VAM030B3/40/2	4000	668	615	30	55	2	85,00	1.169,00

EQUIPMENT

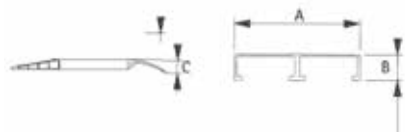

PLOOIBAAR

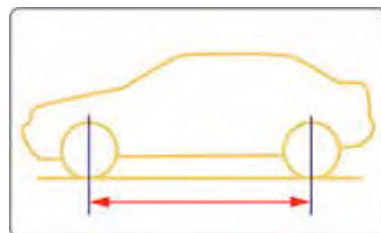

Wielbasis

Set aluminium oprijplaten. Flex platen.

Kenmerken:

- Model met flexibele eigenschappen zonder opstaande rand.
- Verschillende koppen en veiligheidsopties zijn leverbaar (zie optietabel).
- Afwijkende afmetingen zijn op bestelling leverbaar.
- Gewicht afgebeeld per paar.

Geleverd met:

- Geleverd met standaardkop en aluminium veiligheidshaak tegen het wegslaan tijdens het gebruik.

Order nr.	Orig. nr.	Lengte	Cap./paar wielbasis	Externe	Profiel	Hoogte	Aantal	Gewicht	Prijs
		mm	1000mm	breedte (A)	hoogte (B)	(C)		kg	€
754752658	VAM040B2/15	1500	1580	215	40	55	2	14,00	399,00
754752659	VAM040B2/20	2000	1259	215	40	55	2	18,00	442,00
754752660	VAM040B2/25	2500	839	215	40	55	2	22,00	475,00
754752661	VAM040B2/30	3000	598	215	40	55	2	25,00	589,00
754752662	VAM040B2/35	3500	453	215	40	55	2	29,00	649,00
754752663	VAM040B2/40	4000	357	215	40	55	2	33,00	685,00
754752664	VAM040B2/15/2	1500	2900	415	40	55	2	26,00	599,00
754752665	VAM040B2/20/2	2000	2518	415	40	55	2	33,00	659,00
754752666	VAM040B2/25/2	2500	1678	415	40	55	2	41,00	739,00
754752667	VAM040B2/30/2	3000	1197	415	40	55	2	48,00	865,00
754752668	VAM040B2/35/2	3500	907	415	40	55	2	56,00	935,00
754752669	VAM040B2/40/2	4000	714	415	40	55	2	63,00	1.009,00
754752670	VAM040B3/15	1500	2370	315	40	55	2	21,00	464,00
754752671	VAM040B3/20	2000	2132	315	40	55	2	27,00	525,00
754752672	VAM040B3/25	2500	1421	315	40	55	2	33,00	589,00
754752673	VAM040B3/30	3000	1012	315	40	55	2	39,00	709,00
754752674	VAM040B3/35	3500	767	315	40	55	2	45,00	779,00
754752675	VAM040B3/40	4000	604	315	40	55	2	51,00	845,00
754752676	VAM040B3/15/2	1500	2900	615	40	55	2	40,00	729,00
754752677	VAM040B3/20/2	2000	2900	615	40	55	2	52,00	845,00
754752678	VAM040B3/25/2	2500	2842	615	40	55	2	64,00	905,00
754752679	VAM040B3/30/2	3000	2025	615	40	55	2	76,00	1.059,00
754752680	VAM040B3/35/2	3500	1535	615	40	55	2	88,00	1.189,00
754752681	VAM040B3/40/2	4000	1208	615	40	55	2	100,00	1.299,00

BESTSELLER

BESTSELLER



EQUIPMENT

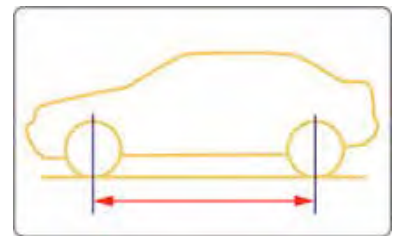
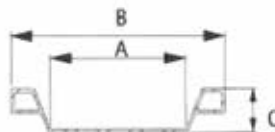

Wielbasis

Set smalle aluminium oprijplaten met veiligheidsrand.

Kenmerken:

- Verschillende veiligheidsopties zijn leverbaar (zie optietabel).
- Afwijkende afmetingen zijn op bestelling leverbaar.
- Gewicht afgebeeld per paar.

Order nr.	Orig. nr.	Lengte	Cap./paar wielbasis 1000mm	Interne breedte (A)	Externe breedte (B)	Hoogte rand (C)	Hoogte (D)	Aantal	Ge- wicht	Prijs
		mm	kg	mm	mm	mm	mm		kg	€
754752706	VAM050/10	1000	1500	155	246	45	100	2	9,00	345,00
754752707	VAM050/15	1500	1500	155	246	45	100	2	13,00	388,00
754752708	VAM050/20	2000	1479	155	246	45	100	2	17,00	420,00
754752709	VAM050/25	2500	887	155	246	45	100	2	20,00	525,00
754752710	VAM050/30	3000	628	155	246	45	100	2	24,00	565,00
754752711	VAM050/35	3500	485	155	246	45	100	2	28,00	649,00

BESTSELLER

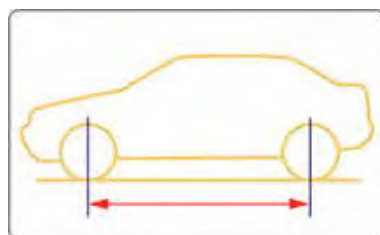
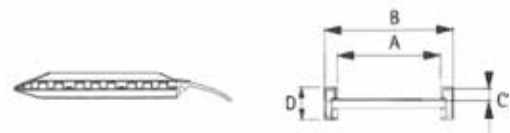
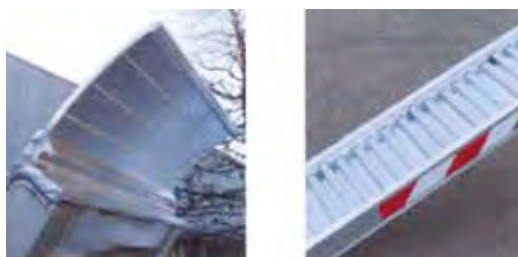

Wielbasis

Set aluminium oprijplaten.

Kenmerken:

- Verschillende koppen en veiligheidsopties zijn leverbaar (zie optietabel).
- Afwijkende afmetingen zijn op bestelling leverbaar.
- Gewicht afgebeeld per paar.

Geleverd met:

- Standaardkop en aluminium veiligheidshaak tegen het wegslaan tijdens het gebruik.

Order nr.	Orig. nr.	Lengte	Cap./paar wielbasis	Interne breedte	Externe breedte	Hoogte rand	Profiel hoogte	Minimum bandbreedte	Aantal	Gewicht	Prijs
		mm	1250mm kg	(A) mm	(B) mm	(C) mm	(D) mm	mm		kg	€
754752718	VAM070/15	1500	2457	240	300	23	70	150	2	19,00	509,00
754752719	VAM070/20	2000	2457	240	300	23	70	150	2	24,00	555,00
754752720	VAM070/25	2500	1525	240	300	23	70	150	2	28,00	659,00
754752721	VAM070/30	3000	1085	240	300	23	70	150	2	34,00	779,00
754752722	VAM070/35	3500	845	240	300	23	70	150	2	39,00	839,00
754752723	VAM070/40	4000	706	240	300	23	70	150	2	43,00	905,00
754752724	VAM070/15L	1500	2450	440	500	23	70	300	2	26,00	635,00
754752725	VAM070/20L	2000	2450	440	500	23	70	300	2	32,00	699,00
754752726	VAM070/25L	2500	1525	440	500	23	70	300	2	38,00	815,00
754752727	VAM070/30L	3000	1085	440	500	23	70	300	2	46,00	909,00
754752728	VAM070/35L	3500	845	440	500	23	70	300	2	52,00	975,00
754752729	VAM070/40L	4000	706	440	500	23	70	300	2	58,00	1.085,00

BESTSELLER

TOOLS



NEW

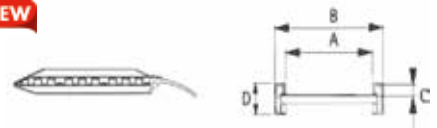

Set aluminium oprijplaten.

Kenmerken:

- Verschillende koppen en veiligheidsopties zijn leverbaar (zie optietabel)
- Afwijkende afmetingen zijn op bestelling leverbaar
- Gewicht afgebeeld per paar

Geleverd met:

- Standaardkop en aluminium veiligheidshaak tegen het wegslaan tijdens het gebruik

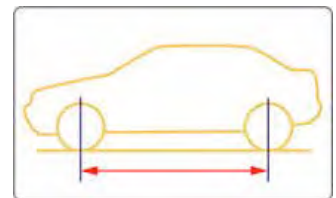

Wielbasis

Order nr.	Orig. nr.	Lengte mm	Cap./paar wiel- basis 1000mm kg	Cap./paar wiel- basis 1500mm kg	Interne breedte (A) mm	Externe breedte (B) mm	Hoogte rand (C) mm	Profiel hoogte (D) mm	Gewicht kg	Prijs €
754752510	VAM075/20	2000	3200	3500	240	300	19	75	32,00	739,00
754752511	VAM075/25	2500	2150	3200	240	300	19	75	39,00	819,00
754752512	VAM075/30	3000	1600	2150	240	300	19	75	43,00	1.029,00
754752513	VAM075/35	3500	1300	1600	240	300	19	75	49,00	979,00
754752514	VAM075/40	4000	1100	1300	240	300	19	75	54,00	1.199,00
754752515	VAM075/45	4500	900	1050	240	300	19	75	62,00	1.149,00

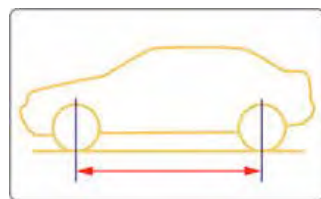

Set aluminium oprijplaten.

Kenmerken:

- Verschillende koppen en veiligheidsopties zijn leverbaar (zie optietabel).
- Afwijkende afmetingen zijn op bestelling leverbaar.
- Gewicht afgebeeld per paar.

Geleverd met:

- Standaardkop en aluminium veiligheidshaak tegen het wegslaan tijdens het gebruik.

Order nr.	Orig. nr.	Lengte	Cap./paar wielbasis	Interne breedte	Externe breedte	Hoogte rand	Profiel hoogte	Minimum band-breedte	Aantal	Gewicht	Prijs
		mm	1500mm	(A)	(B)	(C)	(D)	mm		kg	€
			kg	mm	mm	mm	mm				
754752730	VAM080/20	2000	2457	240	300	23	80	150	2	26,00	635,00
754752731	VAM080/25	2500	2457	240	300	23	80	150	2	31,00	685,00
754752732	VAM080/30	3000	1674	240	300	23	80	150	2	38,00	825,00
754752733	VAM080/35	3500	1255	240	300	23	80	150	2	43,00	905,00
754752734	VAM080/40	4000	1004	240	300	23	80	150	2	48,00	935,00
754752735	VAM080/45	4500	837	240	300	23	80	150	2	55,00	1.075,00

BESTSELLER

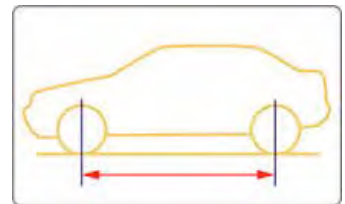
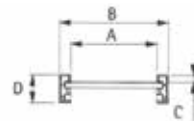
Wielbasis

Set aluminium oprijplaten.

Kenmerken:

- Verschillende koppen en veiligheidsopties zijn leverbaar (zie optietabel).
- Afwijkende afmetingen zijn op bestelling leverbaar.
- Gewicht afgebeeld per paar.

Geleverd met:

- Standaardkop en aluminium veiligheidshaak tegen het wegslaan tijdens het gebruik.

Order nr.	Orig. nr.	Lengte	Cap./paar wielbasis	Interne breedte	Externe breedte	Hoogte rand	Profiel hoogte	Minimum bandbreedte	Aantal	Gewicht	Prijs
		mm	1500mm	(A)	(B)	(C)	(D)	mm		kg	€
754752736	VAM100/25	2500	3000	300	360	23	100	200	2	40,00	775,00
754752737	VAM100/30	3000	2330	300	360	23	100	200	2	42,00	779,00
754752740	VAM100/35	3500	1750	300	360	23	100	200	2	48,00	955,00
754752741	VAM100/40	4000	1400	300	360	23	100	200	2	53,00	1.049,00
754752742	VAM100/45	4500	1165	300	360	23	100	200	2	61,00	1.139,00
754752743	VAM100/50	5000	1000	300	360	23	100	200	2	66,00	1.275,00
754752744	VAM100/25L	2500	3000	340	400	23	100	300	2	43,00	815,00
754752745	VAM100/30L	3000	2330	340	400	23	100	300	2	52,00	925,00
754752747	VAM100/35L	3500	1750	340	400	23	100	300	2	51,00	985,00
754752748	VAM100/40L	4000	1400	340	400	23	100	300	2	56,00	1.079,00
754752749	VAM100/45L	4500	1165	340	400	23	100	300	2	64,00	1.139,00
754752750	VAM100/50L	5000	1000	340	400	23	100	300	2	70,00	1.265,00

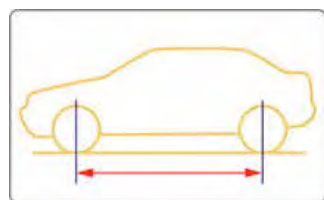

Set aluminium oprijplaten.

Kenmerken:

- Verschillende koppen en veiligheidsopties zijn leverbaar (zie optietabel).
- Afwijkende afmetingen zijn op bestelling leverbaar.
- Gewicht afgebeeld per paar.

Geleverd met:

- Standaardkop en aluminium veiligheidshaak tegen het wegslaan tijdens het gebruik.

Order nr.	Orig. nr.	Lengte	Cap./paar wielbasis 1500mm	Interne breedte (A)	Externe breedte (B)	Hoogte rand (C)	Profiel hoogte (D)	Minimum bandbreedte	Aantal	Gewicht	Prijs	
		mm	kg	mm	mm	mm	mm	mm		kg	€	
754752751	ⓔ VAM115/25	2500	3700	300	360	36	115	200	2	42,00	805,00	BESTSELLER
754752752	ⓔ VAM115/30	3000	3000	300	360	36	115	200	2	45,00	865,00	BESTSELLER
754752754	ⓔ VAM115/35	3500	2250	300	360	36	115	200	2	51,00	865,00	
754752756	ⓔ VAM115/40	4000	1800	300	360	36	115	200	2	57,00	1.085,00	
754752757	ⓔ VAM115/45	4500	1500	300	360	36	115	200	2	65,00	1.185,00	
754752758	ⓔ VAM115/50	5000	1285	300	360	36	115	200	2	70,00	1.275,00	
754752759	ⓔ VAM115/25L	2500	4000	340	400	36	115	300	2	45,00	825,00	
754752760	ⓔ VAM115/30L	3000	3000	340	400	36	115	300	2	54,00	935,00	
754752762	ⓔ VAM115/35L	3500	2250	340	400	36	115	300	2	62,00	1.075,00	
754752763	ⓔ VAM115/40L	4000	1800	340	400	36	115	300	2	69,00	1.169,00	
754752764	ⓔ VAM115/45L	4500	1500	340	400	36	115	300	2	78,00	1.259,00	
754752765	ⓔ VAM115/50L	5000	1285	340	400	36	115	300	2	86,00	1.399,00	
754752766	ⓔ VAM125/25	2500	4500	300	360	36	125	200	2	47,00	855,00	
754752767	ⓔ VAM125/30	3000	4500	300	360	36	125	200	2	58,00	969,00	
754752769	ⓔ VAM125/35	3500	3435	300	360	36	125	200	2	66,00	975,00	
754752771	ⓔ VAM125/40	4000	2750	300	360	36	125	200	2	73,00	1.079,00	
754752773	ⓔ VAM125/45	4500	2290	300	360	36	125	200	2	84,00	1.299,00	
754752774	ⓔ VAM125/50	5000	1965	300	360	36	125	200	2	92,00	1.455,00	
754752775	ⓔ VAM125/25L	2500	4500	340	400	36	125	300	2	50,00	835,00	BESTSELLER
754752776	ⓔ VAM125/30L	3000	4500	340	400	36	125	300	2	61,00	985,00	
754752778	ⓔ VAM125/35L	3500	3435	340	400	36	125	300	2	69,00	1.139,00	
754752779	ⓔ VAM125/40L	4000	2750	340	400	36	125	300	2	78,00	1.249,00	
754752780	ⓔ VAM125/45L	4500	2290	340	400	36	125	300	2	89,00	1.355,00	
754752781	ⓔ VAM125/50L	5000	1965	340	400	36	125	300	2	97,00	1.505,00	

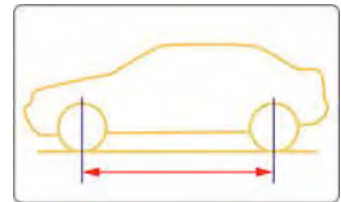

Wielbasis

Set aluminium oprijplaten.

Kenmerken:

- Verschillende koppen en veiligheidsopties zijn leverbaar (zie optietabel).
- Afwijkende afmetingen zijn op bestelling leverbaar.
- Gewicht afgebeeld per paar.

Geleverd met:

- Standaardkop en stalen veiligheidsbeugel tegen het wegslaan tijdens het gebruik.

Order nr.	Orig. nr.	Lengte	Cap./paar wielbasis	Interne breedte	Externe breedte	Hoogte rand	Profiel hoogte	Minimum band- breedte	Aantal	Gewicht	Prijs
		mm	1500mm kg	(A) mm	(B) mm	(C) mm	(D) mm	mm		kg	€
754752782	VAM140/25	2500	4500	340	400	32	140	300	2	55,00	965,00
754752783	VAM140/30	3000	4500	340	400	32	140	300	2	67,00	1.075,00
754752785	VAM140/35	3500	4155	340	400	32	140	300	2	76,00	1.115,00
754752787	VAM140/40	4000	3325	340	400	32	140	300	2	85,00	1.139,00
754752789	VAM140/45	4500	2770	340	400	32	140	300	2	96,00	1.465,00
754752790	VAM140/50	5000	2375	340	400	32	140	300	2	105,00	1.635,00
754752791	VAM140/25L	2500	4500	420	480	32	140	300	2	63,00	1.095,00
754752792	VAM140/30L	3000	4500	420	480	32	140	350	2	77,00	1.169,00
754752794	VAM140/35L	3500	4155	420	480	32	140	300	2	87,00	1.319,00
754752795	VAM140/40L	4000	3325	420	480	32	140	350	2	98,00	1.455,00
754752796	VAM140/45L	4500	2770	420	480	32	140	350	2	111,00	1.659,00
754752797	VAM140/50L	5000	2375	420	480	32	140	350	2	122,00	1.829,00

BESTSELLER

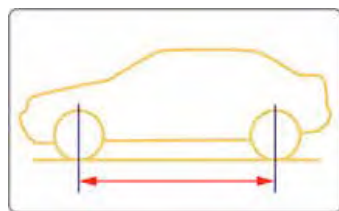

Set aluminium oprijplaten.

Kenmerken:

- Verschillende koppen en veiligheidsopties zijn leverbaar (zie optietabel).
- Afwijkende afmetingen zijn op bestelling leverbaar.
- Gewicht afgebeeld per paar.

Geleverd met:

- Standaardkop en stalen veiligheidsbeugel tegen het wegslaan tijdens het gebruik.

Order nr.	Orig. nr.	Lengte	Cap./paar wielbasis	Interne breedte (A)	Externe breedte (B)	Hoogte rand (C)	Profiel hoogte (D)	Minimum band- breedte	Aantal	Gewicht	Prijs
		mm	1750mm kg	mm	mm	mm	mm	mm		kg	€
754752798	VAM150/25	2500	6000	340	400	32	150	300	2	61,00	1.075,00
754752799	VAM150/30	3000	6000	340	400	32	150	300	2	74,00	1.159,00
754752801	VAM150/35	3500	5890	340	400	32	150	300	2	84,00	1.315,00
754752802	VAM150/40	4000	4580	340	400	32	150	300	2	91,00	1.269,00
754752804	VAM150/45	4500	3745	340	400	32	150	300	2	103,00	1.615,00
754752805	VAM150/50	5000	3170	340	400	32	150	300	2	116,00	1.769,00

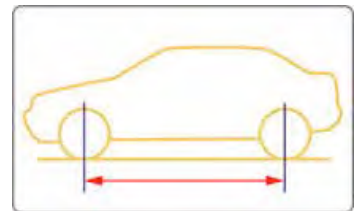

Wielbasis

Set aluminium oprijplaten.

Kenmerken:

- Verschillende koppen en veiligheidsopties zijn leverbaar (zie optietabel).
- Afwijkende afmetingen zijn op bestelling leverbaar.
- Gewicht afgebeeld per paar.

Geleverd met:

- Standaardkop en veiligheidsketting tegen het wegslaan tijdens het gebruik.

Order nr.	Orig. nr.	Lengte	Cap./paar wielbasis	Interne breedte	Externe breedte	Hoogte rand	Profiel hoogte	Minimum band- breedte	Aantal	Gewicht	Prijs
		mm	1750mm kg	(A) mm	(B) mm	(C) mm	(D) mm			kg	€
754752806	VAM165/25	2500	6000	420	480	43	165	350	2	74,00	1.149,00
754752807	VAM165/30	3000	6000	420	480	43	165	350	2	91,00	1.299,00
754752809	VAM165/35	3500	6000	420	480	43	165	350	2	103,00	1.475,00
754752810	VAM165/40	4000	5620	420	480	43	165	350	2	114,00	1.625,00
754752811	VAM165/45	4500	4600	420	480	43	165	350	2	130,00	1.839,00
754752812	VAM165/50	5000	3890	420	480	43	165	350	2	142,00	2.005,00 BESTSELLER
754752813	VAM165/25L	2500	6000	450	510	43	165	400	2	76,00	1.189,00
754752814	VAM165/30L	3000	6000	450	510	43	165	400	2	93,00	1.299,00
754752816	VAM165/35L	3500	6000	450	510	43	165	400	2	105,00	1.535,00
754752817	VAM165/40L	4000	5620	450	510	43	165	400	2	118,00	1.575,00
754752819	VAM165/45L	4500	4600	450	510	43	165	400	2	135,00	1.885,00
754752820	VAM165/50L	5000	3890	450	510	43	165	400	2	147,00	2.055,00 BESTSELLER

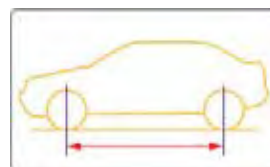
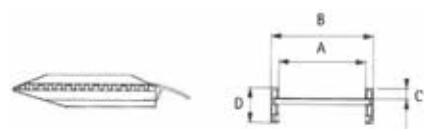

Set aluminium oprijplaten.

Kenmerken:

- Verschillende koppen en veiligheidsopties zijn leverbaar (zie optietabel).
- Afwijkende afmetingen zijn op bestelling leverbaar.
- Gewicht afgebeeld per paar.

Geleverd met:

- Standaardkop en aluminium veiligheidshaak tegen het wegslaan tijdens het gebruik.

Order nr.	Orig. nr.	Lengte	Cap./paar wiel- basis 2000mm	Interne breedte (A)	Externe breedte (B)	Hoogte rand (C)	Profiel hoogte (D)	Minimum bandbreedte	Aantal	Ge- wicht	Prijs
		mm	kg	mm	mm	mm	mm	mm		kg	€
754752821	VAM170/25	2500	8300	450	530	50	170	400	2	84,00	1.355,00
754752822	VAM170/30	3000	8300	450	530	50	170	400	2	103,00	1.515,00
754752823	VAM170/35	3500	8300	450	530	50	170	400	2	118,00	1.719,00
754752824	VAM170/40	4000	6384	450	530	50	170	400	2	127,00	1.729,00
754752826	VAM170/45	4500	5745	450	530	50	170	400	2	144,00	1.949,00
754752828	VAM170/50	5000	4788	450	530	50	170	400	2	157,00	2.309,00
754752829	VAM170/55	5500	4140	450	530	50	170	400	2	170,00	2.429,00
754752830	VAM185/25	2500	10000	450	530	57	185	400	2	100,00	1.485,00
754752831	VAM185/30	3000	10000	450	530	57	185	400	2	120,00	1.645,00
754752832	VAM185/35	3500	10000	450	530	57	185	400	2	136,00	1.855,00
754752833	VAM185/40	4000	8876	450	530	57	185	400	2	148,00	2.025,00
754752834	VAM185/45	4500	7100	450	530	57	185	400	2	160,00	2.055,00
754752836	VAM185/50	5000	5917	450	530	57	185	400	2	175,00	2.459,00
754752837	VAM185/55	5500	5072	450	530	57	185	400	2	190,00	2.575,00

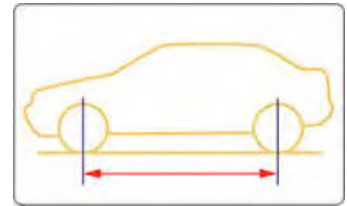
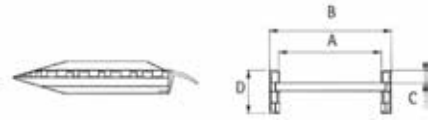

Set aluminium oprijplaten.

Geleverd met:

- Standaardkop en veiligheidsketting tegen het wegslaan tijdens het gebruik.

Kenmerken:

- Verschillende koppen en veiligheidsopties zijn leverbaar (zie optietabel).
- Afwijkende afmetingen zijn op bestelling leverbaar.
- Gewicht afgebeeld per paar.

Order nr.	Orig. nr.	Lengte	Cap./paar wielbasis 2000mm	Interne breedte (A)	Externe breedte (B)	Hoogte rand (C)	Profiel hoogte (D)	Minimum bandbreedte	Aantal	Gewicht	Prijs	
		mm	kg	mm	mm	mm	mm	mm		kg	€	
754752838	E	VAM200/25	2500	12000	500	600	57	200	450	2	112,00	1.759,00
754752839	E	VAM200/30	3000	12000	500	600	57	200	450	2	137,00	1.969,00
754752840	E	VAM200/35	3500	12000	500	600	57	200	450	2	156,00	2.209,00
754752841	E	VAM200/40	4000	10625	500	600	57	200	450	2	174,00	2.355,00
754752842	E	VAM200/45	4500	8500	500	600	57	200	450	2	198,00	2.605,00
754752843	E	VAM200/50	5000	7085	500	600	57	200	450	2	206,00	2.809,00
754752844	E	VAM200/55	5500	6070	500	600	57	200	450	2	223,00	2.959,00
754752845	E	VAM230/25	2500	12000	500	600	71	230	450	2	123,00	1.849,00
754752846	E	VAM230/30	3000	12000	500	600	71	230	450	2	150,00	2.069,00
754752847	E	VAM230/35	3500	12000	500	600	71	230	450	2	171,00	2.339,00
754752848	E	VAM230/40	4000	12000	500	600	71	230	450	2	191,00	2.529,00
754752849	E	VAM230/45	4500	12000	500	600	71	230	450	2	219,00	2.779,00
754752850	E	VAM230/50	5000	10008	500	600	71	230	450	2	239,00	3.119,00
754752851	E	VAM230/55	5500	8578	500	600	71	230	450	2	260,00	3.315,00

EQUIPMENT



VAM V1



VAM V2



VAM V3



VAM V4



VAM K1-K2



VAM K3-K4



VAM K5-K6

Accessoires voor oprijplaten.

Order nr.	Orig. nr.	Omschrijving	Voor type	Gewicht kg	Prijs €	
754752975	E	VAM V1	stalen veiligheidsbeugel	VAM140/150	99,00	63,00
754752976	E	VAM V2	alu veiligheidshaak	VAM030/40/70/80/100/115A/125	99,00	63,00
754752977	E	VAM V3	veiligheidsketting	VAM	99,00	63,00
754752978	E	VAM V4	veiligheids spin	VAM	99,00	15,00
754752979	E	VAM K1	kop met haak 'G'	VAM040/50/70/80/100/115A/125	99,00	187,00
754752980	E	VAM K2	kop met haak 'G'	VAM120S/140/150/165/170/185/200/230	99,00	-
754752981	E	VAM K3	kop met buis 'T'	VAM040/50/70/80/100/115A/125	99,00	187,00
754752982	E	VAM K4	kop met buis 'T'	VAM120S/140/150/165/170/185/200/230	99,00	-
754752983	E	VAM K5	kop met weerhaak 'A'	VAM040/50/70/80/100/115A/125	99,00	187,00
754752984	E	VAM K6	kop met weerhaak 'A'	VAM120S/140/150/165/170/185/200/230	99,00	-



NEW

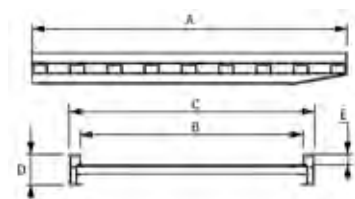

Aluminium loopplank/oprijplaat.

Kenmerken:

- Capaciteit 300 kg
- Lengte 3 tot 5,8 meter

Toepassingen:

- Vullen van containers met kruitwagens
- Overbruggen van oneffen ondergronden, of bergen zand, stenen, takken

Order nr.	Orig. nr.	Laadcapaciteit	Lengte (A)	Interne breedte (B)	Externe breedte (C)	Hoogte profiel (D)	Hoogte rand (E)	Gewicht	Prijs
		kg	mm	mm	mm	mm	mm	kg	€
754752532	VAM070P/30	300	3000	500	560	70	23	18,00	569,00
754752533	VAM070P/40	300	4000	500	560	70	23	24,00	729,00
754752534	VAM070P/50	300	5000	500	560	70	23	30,00	895,00
754752535	VAM070P/58	300	5820	500	560	70	23	36,00	1.015,00

Loop -en rijbruggen

TOOLS



Loopvlak in polyethyleen, versterkt met stalen kruisen onderaan.

Kenmerken:

- Licht en supersterk tegelijk.

Geschikt voor:

- Perfect voor op werven of openbare werken.

Order nr.	758136858 €	
Orig. nr.	RR1400	
Capaciteit	kg	1000
Lengte	mm	1400
Breedte	mm	800
Aantal	1	
Gewicht	kg	22,00
Afmetingen (l x b x h)	mm	1400 x 800 x 50
Prijs	€	205,00

TOOLS



Heavy duty ramp uit rubber. Geschikt voor zware lasten.

Kenmerken:

- Fixatie mogelijk, maar door eigengewicht heel stabiel zonder.
- Eenvoudig te verplaatsen.

Order nr.	745800727 €	
Orig. nr.	RA10	
Lengte	mm	1000
Breedte	mm	750
Aantal	1	
Gewicht	kg	70,00
Afmetingen (l x b x h)	mm	1000 x 750 x 100
Prijs	€	387,00

TOOLS

NEW

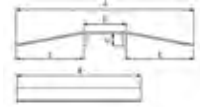
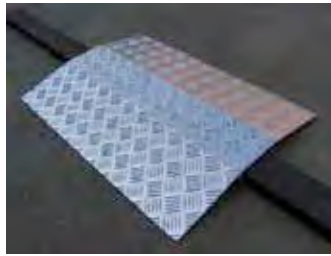

Kabeldremmel in aluminium

Geschikt voor het vlot laten overrijden van palletwagens, steekkarretjes, etc.

Order nr.	754752990 €	
Orig. nr.	VAMBAP1	
Capaciteit	kg	450
Lengte	mm	700
Interne breedte (A)	mm	490
Hoogte rand (C)	mm	40
Hoogte (D)	mm	120
Hoogte rand (E)	mm	185
Aantal	1	
Gewicht	kg	4,00
Afmetingen (l x b x h)	mm	700 x 490 x 40
Prijs	€	253,00

TOOLS

NEW

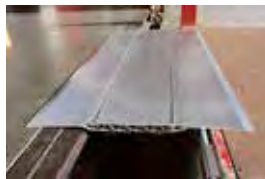

Mobiele laadbrug.

Geschikt voor laadkaaien en vrachtwagens zonder laadbrug.

Voordelen:

- Zeer licht
- hoge capaciteit 2.2 tot 3.4 ton
- ideaal voor laden/lossen met transpallet

Order nr.	Orig. nr.	Capaciteit	Lengte	Aantal	Gewicht	Afmetingen (l x b x h)	Prijs
		kg	mm		kg	mm	€
754752991 €	MS030/625/2TL	3420	627	1	40,00	2200 x 637 x 30	1.059,00
754752992 €	MS030/752/2TL	2895	752	1	40,00	2200 x 752 x 40	1.085,00
754752993 €	MS030/877/2TL	2510	877	1	40,00	2200 x 877 x 45	1.179,00
754752994 €	MS030/1002/2TL	2215	1002	1	40,00	2200 x 1002 x 50	1.429,00

TOOLS

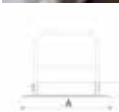

NEW

Aluminium rijbrug met inklapbare leuning.

Rijbruggen met capaciteit tot 4,5 ton.

Kenmerken:

- Aluminium constructie
- Voorzien voor hoge belasting
- Leuningen inklapbaar
- Plint onderaan voorkomt afrollen van objecten

Order nr.	Orig. nr.	Cap./paar wiel-basis 750mm	Cap./paar rups-lengte 1000 mm	Lengte (A)	Plint hoogte (B)	Max. uitgraving-breedte	Interne breedte (C)	Externe breedte (D)	Leuning hoogte (E)	Gewicht	Prijs
		kg	kg	mm	mm	mm	mm	mm	mm	kg	€
754752516	E VAMP12/10	3000	4500	200	200	600	1000	1120	1000	37,00	1.065,00
754752517	E VAMP16/10	3000	4500	200	200	1000	1000	1120	1000	41,00	1.105,00
754752518	E VAMP22/10	3000	4500	200	200	1600	1000	1120	1000	47,00	1.169,00
754752519	E VAMP26/10	3000	3514	200	200	2000	1000	1120	1000	52,00	1.219,00
754752520	E VAMP32/10	2746	2375	200	200	2600	1000	1120	1000	62,00	1.489,00
754752521	E VAMP40/10	1830	1658	200	200	3400	1000	1120	1000	70,00	1.569,00
754752522	E VAMP50/10	1292	1204	200	200	4400	1000	1120	1000	72,00	1.595,00
754752523	E VAMP60/10	998	945	200	200	5400	1000	1120	1000	81,00	1.685,00
754752524	E VAMP12/12	1500	1452	200	200	600	1250	1370	1000	87,00	1.919,00
754752525	E VAMP16/12	1500	1432	200	200	1000	1250	1370	1000	98,00	2.035,00
754752526	E VAMP22/12	1500	1432	200	200	1600	1250	1370	1000	107,00	2.295,00
754752527	E VAMP26/12	1500	1432	200	200	2000	1250	1370	1000	121,00	2.445,00
754752528	E VAMP32/12	1500	1432	200	200	2600	1250	1370	1000	132,00	2.569,00
754752529	E VAMP40/12	1500	1432	200	200	3400	1250	1370	1000	149,00	2.745,00
754752530	E VAMP50/12	1292	1204	200	200	4400	1250	1370	1000	157,00	3.005,00
754752531	E VAMP60/12	998	945	200	200	5400	1250	1370	1000	178,00	3.225,00

TOOLS

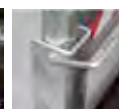
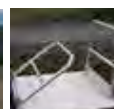

NEW

Aluminium loopbrug met inklapbare leuning.

Loopbruggen met capaciteit tot 400 kg.

Kenmerken:

- Aluminium constructie
- Voorzien voor hoge belasting
- Leuningen inklapbaar
- Plint onderaan voorkomt afrollen van objecten

Order nr.	Orig. nr.	Laadcapaciteit	Lengte (A)	Plint hoogte (B)	Max. uitgraving-breedte	Interne breedte (C)	Externe breedte (D)	Leuning hoogte (E)	Gewicht	Prijs
		kg	mm	mm	mm	mm	mm	mm	kg	€
754752948	E VAMPP12/10	400	200	200	600	1000	1120	1000	34,00	925,00
754752949	E VAMPP16/10	400	200	200	1000	1000	1120	1000	43,00	1.025,00
754752950	E VAMPP22/10	400	200	200	1600	1000	1120	1000	56,00	1.215,00
754752951	E VAMPP26/10	400	200	200	2000	1000	1120	1000	64,00	1.315,00
754752952	E VAMPP32/10	400	200	200	2600	1000	1120	1000	77,00	1.565,00
754752953	E VAMPP40/10	400	200	200	3400	1000	1120	1000	94,00	1.785,00
754752954	E VAMPP50/10	400	200	200	4400	1000	1120	1000	115,00	2.015,00
754752955	E VAMPP60/10	400	200	200	5400	1000	1120	1000	136,00	2.309,00

TOOLS

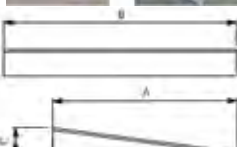
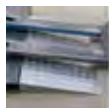

NEW

Aluminium oprijblok op maat.

Toepassingen:

- Toegankelijk maken van containers
- Overbruggen van drempels en dorpels
- Binnenrijden met transpallet en kruiwagens
- Voorkomt schade aan dorpels

Order nr.	Orig. nr.	Laadcapaciteit	Lengte (A)	Breedte (B)	Min/max hoogte (C)	Gewicht	Afmetingen (l x b x h)	Prijs
		kg	mm	mm	mm	kg	mm	€
754752536	E VAMBAC1	430	500	1000	10/70	10,00	500 x 1000 x 70	469,00
754752537	E VAMBAC2	430	650	1000	71/120	14,00	650 x 1000 x 120	506,00
754752538	E VAMBAC3	2920	500	1250	30/70	13,00	500 x 1250 x 70	500,00
754752539	E VAMBAC4	2920	800	1250	71/120	22,00	800 x 1250 x 120	590,00

EQUIPMENT

TOOLS

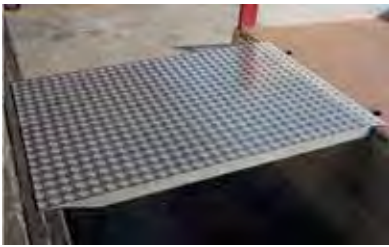

NEW

Draagbare laadbrug. Lange versie

Kenmerken:

- Draagbare laadbrug met 2 lippen
- Draagbaar door 1 persoon
- Ideaal voor het lossen op kaai zonder laadklep
- Overbrugt grote hoogte verschillen tussen vrachtwagen en laadkaai.
- Volledig uit aluminium

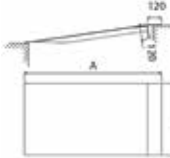

Order nr.	Orig. nr.	Laadcapaciteit	Lengte (A)	Breedte (B)	Minimum laadhoogte	Maximum laadhoogte	Gewicht	Prijs
		kg	mm	mm	mm	mm		
754752540	VAMPL0750L	610	750	1250	0	+90	13,00	536,00
754752541	VAMPL1000L	610	1000	1250	+50	+120	17,00	574,00
754752542	VAMPL1200L	610	1200	1250	+60	+150	20,00	640,00
754752543	VAMPL1500L	610	1500	1250	+80	+190	25,00	721,00
754752544	VAMPL1800L	610	1800	1250	+100	+230	30,00	804,00
754752545	VAMPL0750H	1300	750	1250	0	+90	20,00	554,00
754752546	VAMPL1000H	1300	1000	1250	+50	+120	27,00	605,00
754752547	VAMPL1200H	1300	1200	1250	+60	+150	33,00	770,00
754752548	VAMPL1500H	1300	1500	1250	+80	+190	41,00	884,00
754752549	VAMPL1800H	1300	1800	1250	+100	+230	49,00	996,00

TOOLS

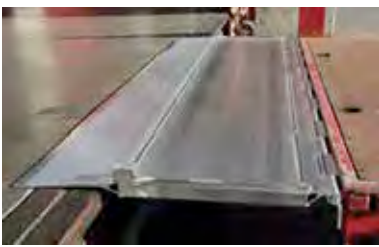

NEW

Vaste laadbrug in alu met scharnier

Kenmerken:

- Laadbrug met stalen scharnier voor bevestiging op vracht- of bestelwagens.
- Doorlopend scharnier met hoge treksterkte en dichting
- Met oplegstuk (lip) voor het lossen op een kaai
- Volledig uit aluminium

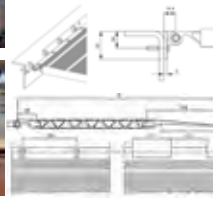

Order nr.	Orig. nr.	Laadcapaciteit	Lengte (A)	Breedte (B)	Gewicht	Prijs
		kg	mm	mm		
754752550	VAMS030AC/565	4170	565	min. 1250	19,00	497,00
754752551	VAMS030AC/690	3420	690	min. 1250	21,00	521,00
754752552	VAMS030AC/815	2890	815	min. 1250	25,00	621,00
754752553	VAMS030AC/940	2510	940	min. 1250	27,00	637,00
754752554	VAMS030AC1065	2210	1065	min. 1250	30,00	664,00
754752555	VAMS030AC/1190	1980	1190	min. 1250	34,00	754,00
754752556	VAMS030AC/1315	1790	1315	min. 1250	36,00	780,00
754752557	VAMS030AC/1565	1300	1565	min. 1250	42,00	920,00
754752558	VAMS030AC/1690	1100	1690	min. 1250	45,00	986,00
754752559	VAMS030AC/1815	950	1815	min. 1250	48,00	1.036,00
754752560	VAMS030AC/2065	720	2065	min. 1250	54,00	1.167,00

TOOLS

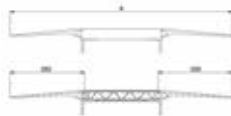

NEW

Draagbare laadbrug.

Kenmerken:

- Draagbare laadbrug met 2 lippen
- Draagbaar door 1 persoon
- Ideaal voor het lossen op kaai zonder laadklep
- Overbrugt verschillen in laadhoogte
- Volledig in aluminium

Order nr.	Orig. nr.	Laadcapaciteit	Lengte (A)	Breedte (B)	Minimum laadhoogte	Maximum laadhoogte	Gewicht	Prijs
		kg	mm	mm	mm	mm		
754752561	VAMS0302TL/625	3420	627	min. 1250	-30	+30	17,00	489,00
754752562	VAMS0302TL/750	2895	752	min. 1250	-40	+40	19,00	505,00
754752563	VAMS0302TL/875	2510	877	min. 1250	-45	+45	22,00	532,00
754752564	VAMS0302TL/1000	2210	1002	min. 1250	-50	+50	25,00	621,00

Elektrische takels 12V & 24V

SUPERWINCH



LT2000



UT3000



Elektrische lieren 12V.

Krachtige en betrouwbare instapmodellen.

Compleet geleverd met:

- Rubber afstandsbediening met kabel 1,15 m
- Kabelgeleider
- Montageplaat
- Katrol
- Manuele koppeling/vrijloop

UT3000: dynamische rem, volmetalen overbrenging

Meer info op www.superwinch.com.

Order nr.		758201228 €	758201230 €
Orig. nr.		LT2000	UT300012V
Spanning	V	12	12
Grenscapaciteit	kg	907	1361
Technische capaciteit	kg	630	880
Vermogen motor	kW	0,5	0,9
Overbrenging		153:1	153:1
Kabel diameter	mm	4	4,8
Kabel lengte	m	15,2	12
Diameter drum	mm	31,75	31,80
lengte drum	mm	73,6	72
Snelheid - benodigde Ampère bij belasting 0 kg	m/min - A	3,0 - 10	2,6 - 5
Snelheid - benodigde Ampère bij belasting 907 kg	m/min - A	2,5 - 100	1,2 - 65
Snelheid - benodigde Ampère bij belasting 1361 kg	m/min - A		0,6 - 110
Gewicht	kg	5,90	8,90
Afmetingen (l x b x h)	mm	317 x 100 x 104	305 x 190 x 178
Prijs	€	238,00	278,00

HOE KIES JE EEN GESCHIKTE TAKEL?

Het Superwinch-assortiment bevat 4 groepen lieren: De instapmodellen, de all-round lieren, de industriële modellen en de hydraulische lieren. De belangrijkste parameters zijn voltage, snelheid en capaciteit. De grenscapaciteit is de last die de lier kan trekken als de kabel op de eerste laag van de drum ligt. De technische capaciteit geldt voor de 4de laag van de drum, en is dus van toepassing voor het takelen vlakbij de lier.

De last die getrokken dient te worden, kan als volgt berekend worden:

FORMULE $(Y \times Z \times 0,017) + (Y \times F)$

Y = gewicht van het voertuig in kg

Z = aantal graden waaronder de wagen dient getrokken te worden

F = factor van de ondergrond

vb: wagen 2000 kg trekken onder een hoek van 20 graden op een trailer

$(2000 \times 20 \times 0,017) + (2000 \times 0,05)$

$680 + 100 = 780$ kg (technische capaciteit)

Hiervoor heb je dus minimum een lier nodig die een technische capaciteit heeft van 780 kg.

Type ondergrond

Hard-metaal-asfalt	0,05
Gras	0,15
Zand (hard - nat)	0,17
Gravel	0,2
Zand (zacht - nat)	0,2
Zand (zacht - droog/los)	0,25
Modder (ondiep)	0,33
Moeras	0,5
Klei	0,5

Factor (F)

0,05
0,15
0,17
0,2
0,2
0,25
0,33
0,5
0,5

OPMERKING:
SUPERWINCH TAKELS MOGEN NIET
GEBRUIKT WORDEN OM TE HEFFEN
ENKEL OM TE TREKKEN!

SUPERWINCH

Elektrische lieren 12V.

Betrouwbare en performante modellen.

Compleet geleverd met:

- Rubber afstandsbediening met kabel L.3,5m
- Haak
- Weersbestendige motor
- Manuele koppeling/vrijloop
- Kabelleider (LP10000)
- Circuitbeveiliging



LP8500



LP10000

Zonder montageplaat.

Meer info op www.superwinch.com

Order nr.		758208500 €	758208600 €
Orig. nr.		LP8500	LP10000
Spanning	V	12	12
Grenscapaciteit	kg	3856	4536
Technische capaciteit	kg	2600	2880
Vermogen motor	kW	3,37	3,8
Overbrenging		235:1	235:1
Kabel diameter	mm	8,3	9,5
Kabel lengte	m	29	26
Diameter drum	mm	63,50	
Lengte drum	mm	224,00	
Snelheid - benodigde Ampère bij belasting 0 kg	m/min - A	5,5 - 84	5,7 - 85
Snelheid - benodigde Ampère bij belasting 1134 kg	m/min - A	3,0 - 156	
Snelheid - benodigde Ampère bij belasting 2041 kg	m/min - A	2,3 - 215	
Snelheid - benodigde Ampère bij belasting 2948 kg	m/min - A	1,8 - 270	
Snelheid - benodigde Ampère bij belasting 3856 kg	m/min - A	1,1 - 320	
Snelheid - benodigde Ampère bij belasting 2721 kg	m/min - A		2,2 - 245
Snelheid - benodigde Ampère bij belasting 4536 kg	m/min - A		1,5 - 350
Gewicht	kg	34,50	40,80
Afmetingen (l x b x h)	mm	533 x 160 x 218	533 x 160 x 218
Prijs	€	759,00	929,00

EQUIPMENT

SUPERWINCH



S5000



Rubber afstandsbediening

Elektrische lieren 12 en 24 V.

Standaard geleverd met :

- Rubber afstandbediening met kabel van 9 m
- Automatische mechanische rem
- Power in/uit
- Manuele koppeling/vrijloop
- Continue smering van de aandrijving
- Kabel met aansluiting op de takel
- Circuitbeveiliging
- Kabelgeleiding
- De takels kunnen zonder plaat direct gemonteerd worden

Meer info op www.superwinch.com

Order nr.		758204402 E	758204403 E	758204502 E	758204503 E
Orig. nr.		S400012V	S400024V	S500012V	S500024V
Spanning	V	12	24	12	24
Grenscapaciteit	kg	1820	1820	2270	2270
Technische capaciteit	kg	1235	1235	1475	1475
Vermogen motor	kW	1,3	1,3	1,6	1,6
Overbrenging		153:1	153:1	153:1	153:1
Kabel diameter	mm	5,5	5,5	6,4	6,4
Kabel lengte	m	18,2	18,2	15,2	15,2
Diameter drum	mm	41	41	41	41
Lengte drum	mm	76	76	76	76
Snelheid - benodigde Ampère bij belasting 0 kg	m/min - A	9,7 - 30		9,4 - 36	
Snelheid - benodigde Ampère bij belasting 1134 kg	m/min - A	3,2 - 180			
Snelheid - benodigde Ampère bij belasting 907 kg	m/min - A	3,8 - 155		3,4 - 135	
Snelheid - benodigde Ampère bij belasting 1361 kg	m/min - A	2,7 - 215		2,2 - 200	
Snelheid - benodigde Ampère bij belasting 454 kg	m/min - A	4,8 - 90		4,6 - 80	
Snelheid - benodigde Ampère bij belasting 1589 kg	m/min - A	1,9 - 250			
Snelheid - benodigde Ampère bij belasting 1814 kg	m/min - A	1,4 - 311		1,3 - 265	
Snelheid - benodigde Ampère bij belasting 2268 kg	m/min - A			1,4 - 350	
Gewicht	kg	18,20	18,20	19,10	19,10
Afmetingen (l x b x h)	mm	384 x 220 x 152	384 x 220 x 152	384 x 220 x 152	384 x 220 x 152
Prijs	€	719,00	787,00	844,00	919,00

SUPERWINCH



Elektrische lieren 12 en 24 V.

Professionele, betrouwbare en snelle takels voor montage op vrachtwagens, aanhangwagens, terreinwagens, ... Gebouwd voor gebruik in zware omstandigheden.

Kenmerken:

- Automatische mechanische rem
- Manuele vrijloop
- 2-traps overbrenging
- Circuitbeveiliging met speciaal ontwikkelde, waterdichte solenoïde

Standaard geleverd met:

- Kabel
- Zware haak
- 4-weg kabelgeleiding en afstandbediening 4,5 m

Op aanvraag leverbaar in uitvoering met synthetisch touw

Meer info op www.superwinch.com

Order nr.	758307956 €	758307959 €	758307970 €	758307973 €	758307989 €	758307992 €
Orig. nr.	TALON 95I-12V	TALON 95I-24V	TALON 125I-12V	TALON 125I-24V	TALON 180-12V	TALON 180-24V
Spanning	V 12	24	12	24	12	24
Grenscapaciteit	kg 4309	4309	5670	5670	8165	8165
Vermogen motor	kW 3,8	3,8	4,48	4,48	4,48	4,48
Overbrenging	148:1	148:1	148:1	148:1	346:1	346:1
Kabel diameter	mm 9,5	9,5	9,5	9,5	13	13
Kabel lengte	m 26	26	26	26	27	27
Snelheid - Benodigde Ampère onbelast	m/min · A 18,9 - 75	18,9 - 75	18,89 - 75	18,89 - 75	7,62 - 75	7,62 - 75
Snelheid - Benodigde Ampère bij grenscapaciteit	m/min · A 1,5 - 430	1,5 - 430	3,25 - 530	3,25 - 530	0,76 - 415	0,76 - 415
Gewicht	kg 42,00	42,00	43,00	43,00	78,00	78,00
Afmetingen (l x b x h)	mm 615.2 x 157.5 x 270.75	615.2 x 157.5 x 270.75	624.2 x 157.5 x 270.76	624.2 x 157.5 x 270.76	689.5 x 215 x 294.21	689.5 x 215.5 x 294.21
Prijs	€ 1.118,00	1.119,00	1.243,00	1.243,00	1.855,00	1.637,00

SUPERWINCH



Synthetische touwen voor lieren.

Kenmerken:

- Vervaardigd uit Dyneema (R) kwaliteitsvezels.
- Bestand tegen de meeste chemicaliën zoals motoroliën en zout.
- Ze bieden ook hoge weerstand tegen UV-straling en water.
- In tegenstelling tot klassieke staaldraad, verdragen ze hoge piek-ladingen, tot tegen de breeksterkte.
- Veilig in gebruik want lage uitrekking, en weinig terugslag zelfs bij heel zware belasting.
- Extreem sterk, en slechts 1/10 van het gewicht van een even dikke staaldraad.

Order nr.	758209671	758307981	758308000
Orig. nr.	771030	90-24506	90-24564
Voor type	EP6/9	TALON 9.5 en 12.5	TALON 14 en 18
Lengte m	30	24	27
Dikte mm	10	9,5	13
Gewicht kg	3,00	1,00	1,00
Prijs €	0,00	599,00	899,00

SUPERWINCH



Montageplaat om een Superwinch lier op een vloer of bodem vast te maken.

Order nr.	758208501	758303223	758302314	758302315
Orig. nr.	258007	258001	258006	216001
Voor type	LP8500/10000	EP6-EP9-Tal. 9.5-Tal. 12.5	EP12,5 - EP16,5	EP14 - EP18
Gewicht kg	5,00	1,00	1,00	1,00
Prijs €	205,00	214,00	237,93	229,00

SUPERWINCH



Haken - katrollen voor lieren.

Order nr.	758305617
Orig. nr.	SUP7750
Voor type	EP19,TALON, LP8500, LP10000
Gewicht kg	1,00
Prijs €	102,00

SUPERWINCH



Afstandsbediening met of zonder kabel voor Superwinch lieren.

Order nr.	Orig. nr.	Voor type	Lengte m	Type afstandsbediening	Gewicht kg	Prijs €
758205011	2270	GP1800 - GP2300 - GP3000 - S3000 - S4000 - S5000 - EP6 - EP16 - EP9 - EP19 - EP12,5 - EP16,5	4,5	kabel	1,00	108,00
758205012	2271	GP1800 - GP2300 - GP3000 - S3000 - S4000 - S5000 - EP6 - EP16 - EP9 - EP19 - EP12,5 - EP16,5	9	kabel	1,00	124,00
758304811	87-12869	IT2000	2	kabel	1,00	81,50
758201666	90-12864	UT3000-LP8500-IT10000	3,5	kabel	1,00	47,90
758308047	90-32471	TALON	4	kabel	1,00	59,00

SUPERWINCH



Draadloze afstandsbediening Superwinch.

Order nr.	758301508	758301512	758301513
Orig. nr.	06715	6717	6719
Voor type	TALON	S-series	Terra Series
Type afstandsbediening	draadloos	draadloos	draadloos
Gewicht kg	1,00	1,00	1,00
Prijs €	335,00	369,00	369,00

Aircraft



Compacte elektrische lier 12 V.

Geschikt voor het opwinden van lichte voertuigen, machines, boten, ... tot 900 kg.

Kenmerken:

- IP54 spatwater- en stofdicht

Geleverd met:

- Afstandsbediening
- Slipkoppeling tegen overbelasting
- Stevige haak die rond de trekhaak van elk voertuig past (enkel geschikt voor het optakelen)

Order nr.	716190900
Orig. nr.	ESW900
Spanning	V 12
Kabel lengte	m 9
Capaciteit	kg 900
Kabeldikte	mm 5,6
Nominale stroom	A 25
Vermogen	W 300
Treksnelheid	m/min 0,6
Beschermingsklasse	IP 54
Gewicht	kg 13,00
Afmetingen (l x b x h)	mm 570 x 485 x 250
Prijs €	122,00

Mechanische takels

TOOLS



Manuele takel.

Kenmerken:

- 7,6m staalkabel

Geleverd met:

- Haak met veiligheidslip

Order nr.	758580250 €		
Orig. nr.	HNHW250		
Lengte kabel	m	7,6	
Diameter kabel	mm	4	
Capaciteit	kg	1100	
Gewicht	kg	5,25	
Prijs	€	51,50	

TOOLS



NEW

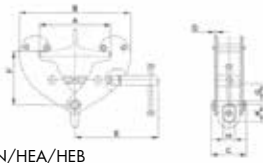

- IPE/IPN/HEA/HEB

Balkenklem 2 ton.

Klem voor het vastmaken van ander hijsgereedschap en van stalen balken.

Kenmerken:

- Hoge capaciteit 2 ton
- Groot klembereik 75-230 mm, met spindel aanpasbaar
- Voor profielen IPE, INP, HEA
- Lage hoogte, weinig plaatsverlies
- Ingelast oog voor snel ophangen aan de hijshaak
- Eenvoudige montage

Order nr.	754751502 €		
Algemeen			
Orig. nr.	BKL2		
Nominale capaciteit	t	2	
Klembereik	mm	75-230	
Afmetingen			
A max.	mm	240	
B min.	mm	192	
B max.	mm	367	
C	mm	102	
D	mm	6	
E	mm	218	
F min.	mm	103	
F max.	mm	155	
G	mm	20	
H	mm	30	
K	mm	45	
Gewicht	kg	5,10	
Afmetingen (l x b x h)	mm	200 x 150 x 100	
Prijs	€	42,00	

TOOLS



NEW

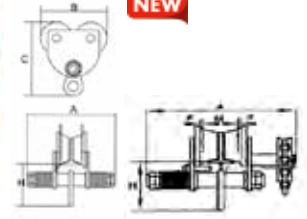

Loopkat 2 ton voor takels.

Kenmerken:

- Duwmodel
- Met ophangoog
- Flensbreedte aanpasbaar aan balkprofiel
- Geschikt voor IPE, IPN, HEA, HEB, ...

Order nr.	758592020 €		
Algemeen			
Orig. nr.	HNRK2T		
Nominale capaciteit	t	2	
Min. straal in geval van gebogen rail	m	1,1	
Afmetingen			
A	mm	236,5	
B	mm	240	
C	mm	262	
E	mm	29	
F	mm	1,5-3	
Balkbreedte (M)	mm	88-146	
Gewicht	kg	21,00	
Prijs	€	56,90	

TOOLS



NEW

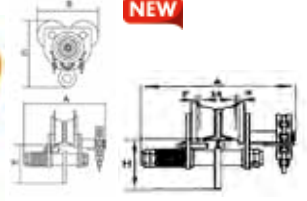

Loopkat 2 ton met kettingaandrijving voor takels.

Kenmerken:

- Verplaatsing met ketting 3 meter
- Loopkat en takel blijven vast staan indien ketting niet wordt bediend
- Met ophangoog
- Flensbreedte aanpasbaar aan balkprofiel
- Geschikt voor IPE, IPN, HEA, HEB, ...

Order nr.	758592525 €		
Algemeen			
Orig. nr.	HNRKG2T		
Nominale capaciteit	t	2	
Min. straal in geval van gebogen rail	m	1,1	
Afmetingen			
A	mm	290,5	
B	mm	240	
C	mm	262	
E	mm	29	
F	mm	1,5-3	
H	mm	140	
Balkbreedte (M)	mm	88-146	
Gewicht	kg	21,00	
Prijs	€	75,90	

EQUIPMENT

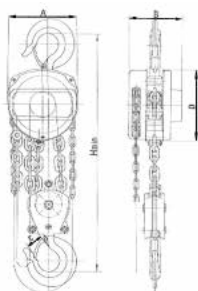

Kettingtaket.

Prima handtaket voor gebruik tot 3 ton.

Met kettingbediening.

Kenmerken:

- Met lastdrukrem die de last op elke positie vasthoudt
- Boven- en onderhaak voorzien van veiligheidsslip
- Verzinkte kettingen

Order nr.	758580525	758581025	758581060	758581525	758582025	758582060	758583030
Orig. nr.	HNSJ0525	HNSJ1025	HNSJ1060	HNSJ1525	HNSJ2025	HNSJ2060	HNSJ3030
Capaciteit	t 0,5	1	1	1,5	2	2	3
Lengte ketting	m 2,5	2,5	6	2,5	2,5	6	3
Testcapaciteit	t 0,75	1,5	1,5	2,25	3	3	4,5
H minimum	mm 271	400	400	453	420	420	620
Nodige kracht voor maximum lift	N 221	304	304	343	314	314	343
Aantal kettingen	1	1	1	1	2	2	2
Schakel kettingen	dia. mm 6	6	6	8	6	8	8
A	mm 138	164	164	198	164	164	198
B	mm 114	124	124	142	124	124	142
C	mm 21,5	27	27	30	30	30	37
D	mm 145	182	182	219	182	182	219
Lengte aandrijfketting	m 5	5	12	5	5	12	6
Gewicht	kg 9,00	11,00	16,95	17,00	15,00	23,75	24,00
Prijs	€ 75,50	80,50	102,00	108,00	110,00	139,00	133,00

EQUIPMENT



Rateltaket.

Deze handtaket is een prima handtaket voor gebruik onder middelzware tot zware omstandigheden. Prima prijs-kwaliteitsverhouding.

Kenmerken:

- Met lastdrukrem die de last op elke positie vasthoudt
- Boven- en onderhaak voorzien van veiligheidsslip
- Verzinkte kettingen

Order nr.	758580750	758581500	758583000
Orig. nr.	HNCRT075	HNCRT150	HNCRT300
Capaciteit	t 0,75	1,5	3
Lengte ketting	m 1,5	1,5	1,5
Testcapaciteit	t 1.13	2,25	4,5
H minimum	mm 325	380	480
Nodige kracht voor maximum lift	N N140	220	320
Schakel kettingen	dia. mm 6	8	10
A	mm 148	172	200
B	mm 90	98	115
C	mm 136	160	180
D	mm 35	47	54
E	mm 29	38	44
L hendel	mm 280	410	410
Gewicht	kg 7,00	11,00	21,00
Prijs	€ 105,00	148,00	235,00



Domme kracht.

Kenmerken:

- Stabiele stalen krik, gebouwd volgens DIN7355
- Gemakkelijk hijsen met weinig inspanning
- Beveiligde zwengel is opklapbaar
- Met eindeloopbeveiliging

Order nr.	716170103	716170105	716170110
Orig. nr.	SW3	SW5	SW10
Capaciteit	t 3	5	10
A	mm 83	108	124
B	mm 130	140	140
C	mm 735-1090	730-1076	800-1190
D	mm 70-425	80-425	100-490
Hoogte	mm 735	730	800
Hefhoogte	mm 235	217	187
E	mm 60	71	86
F	mm 45	68	76
G	mm 138	170	170
H	mm 249	275	300
K	mm 170	190	252
R	mm 140	155	185
S	mm 235	217	187
T	mm 128	128	250
Gewicht	kg 21,00	30,00	48,00
Prijs	€ 195,00	243,00	361,00

TOOLS



2T

Multifunctionele kolomvijzel. Licht en direct inzetbaar in alle omstandigheden

Funcities:

- Verticaal gebruik: voor het snel optillen van bv. auto's, grasmaaiers, tractoren, werktuigen, ...
- Horizontaal gebruik: voor het duwen of trekken van lasten

Kenmerken:

- Groot werkbereik: 130-1325 mm
- Cap. heffen: 400 kg
- Cap. ondersteunen: tot 2000 kg
- Met stabiele voet, veiligheidspal en vaste opklapbare hendel.
- CE conform.

Order nr.	758601032 €	
Orig. nr.	HNFJ2T	
Hefcapaciteit	kg	400
Hefhoogte	mm	130-1325
Maximum belastbare capaciteit	kg	2000
Gewicht	kg	17,00
Afmetingen (l x b x h)	mm	240 x 140 x 1540
Prijs	€	99,00

TOOLS



Kabeltakel.

Kenmerken:

- Capaciteit 2 of 4 ton met staalkabel en bevestigingshaak op beide uiteinden
- Werkt onder alle hoeken, verticaal en horizontaal
- Ideaal werktuig voor boten, auto's, buitenwerk enz.
- Geperste stalen constructie met dubbele pinveiligheid
- Dubbel wiel en dubbele klauw
- Hefratio: 15:1

Order nr.	758580020 €	758580040 €
Orig. nr.	HNP20	HNP40
Capaciteit	t	4
Lengte kabel	m	3
Diameter kabel	mm	5
Gewicht	kg	5,00
Prijs	€	39,50

TOOLS



Staaldraadtakel met doorgaande kabel.

Kenmerken:

- Werkt onder alle hoeken, verticaal en horizontaal, en kan zowel voor hijsen als trekken worden gebruikt. Bvb lasten vereffen, tenten beveiligen, hijsen van kisten, bosbouw, kabels trekken, ...
- Zeer eenvoudig en robuust systeem

Geleverd met:

- 20 m staaldraadkabel met haak en veiligheidsklep en hendel
- Voorzien van een veiligheidspun tegen overbelasting

Order nr.	758580140 €	758580160 €	758583200 €
Orig. nr.	KT800	KT1600	KT3200
Hijsvermogen	kg	800	1600
Trekvermogen	kg	1200	2400
Diameter staaldraad x lengte	mm	8,3 x 20m	11 x 20m
Gewicht	kg	14,50	26,00
Afmetingen (l x b x h)	mm	426 x 238 x 64	545 x 284 x 97
Prijs	€	132,00	219,00

TOOLS



Wisselstukken voor KT-staaldraadtakels.

Order nr.	Orig. nr.	Omschrijving	Voor type	Gewicht kg	Prijs €
758580161 €	KT1600VP	Breekpen	KT1600	0,20	7,00
758580167 €	KT800VP	Breekpen	KT800	0,20	7,00
758580162 €	KT1600K20	Vervangkabel	KT1600	4,00	77,50
758580164 €	KT3200VP	Breekpen	KT3200	0,20	6,80
758580168 €	KT800K20	Vervangkabel	KT800	4,00	0,00
758580165 €	KT3200K20	Vervangkabel	KT3200	4,00	76,50
758580169 €	KT800H	Reservehendel	KT800	1,00	0,00
758580163 €	KT1600H	Reservehendel	KT1600	1,00	20,50
758580166 €	KT3200H	Reservehendel	KT3200	1,00	19,90

EQUIPMENT

Elektrische takels 220V



Robuuste 220 V takels.

Kenmerken:

- Met noodstop op bedieningspaneel.
- Eindeloopsswitch en anti-omkeerswitch.
- IP54 beschermingsklasse en CE gekeurd.
- Chassis voorzien voor montage op de takelhouder PP300/1100 of PP600/750.
- Inschakelduur: 20%: Per 10 minuten kan er 2 minuten gehesen worden.

Geleverd met:

- Afstandsbediening met kabel (1,60m).
- Haak met veiligheidsclip.

Order nr.		758611250 ^E	758612040 ^E	758613060 ^E	758613070 ^E	758611012 ^E
Orig. nr.		SH125/250	SH200/400	SH300/600-12	SH300/600-18	SH500/1000
Capaciteit	kg	125/250	200/400	300/600	300/600	500/1000
Spanning	V	230	230	230	230	230
Type haak		enkel/dubbel	enkel/dubbel	enkel/dubbel	enkel/dubbel	enkel/dubbel
Hefhoogte	m	12/6	12/6	12/6	18/9	18/9
Hefsnelheid	m/min	8/4	8/4	8/4	8/4	8/4
Diameter kabel	mm	3	4	5	5	6
Vermogen motor	kW	0,5	0,75	1,05	1,05	1,6
Lengte kabel afstandsbediening	m	1,6	1,6	1,6	1,6	1,6
Gewicht	kg	12,50	16,50	17,50	36,00	34,00
Afmetingen (l x b x h)	mm	333 x 132 x 200	381 x 147 x 243	381 x 140 x 235	520 x 440 x 240	540 x 440 x 310
Prijs	€	123,00	174,00	195,00	246,00	411,00



NEW

Elektrische takel 300/600 kg met draadloze afstandsbediening.

Kenmerken:

- Radiogestuurde afstandsbediening met 100m bereik.
- Eindeloopsswitch en anti-omkeerswitch.
- IP54 beschermingsklasse en CE gekeurd.
- Inschakelduur: 20%: Per 10 minuten kan er 2 minuten gehesen worden.

Order nr.		758613080 ^E
Orig. nr.		SH300/600-R
Capaciteit	kg	300/600
Spanning	V	220
Type haak		enkel/dubbel
Hefhoogte	m	12/6
Hefsnelheid	m/min	8/4
Diameter kabel	mm	4,5
Vermogen motor	kW	1,05
Draadloos		✓
Kabeldikte	mm	5
Gewicht	kg	34,70
Afmetingen (l x b x h)	mm	520 x 440 x 240
Prijs	€	287,00

TOOLS



Takelhouder voor elektrische takels SH.

Geschikt voor SH125, SH200, SH300 en SH500.

Geleverd met:

- Beugels
- Montagebouten en -moeren voor montage op ronde buizen met diameter 48 mm

Geleverd zonder takel.

NEW

Order nr.	758611001 €	758611010 €	758611030 €
Orig. nr.	PP300/1100	PP600/750	PP1000/750
Geschikt voor modellen	125/250	200/300, 200/400, 300/600	500/1000
Capaciteit kg	300	600	1000
Lengte arm mm	1100	750	750
Gewicht kg	30,00	22,00	22,00
Prijs	€ 72,00	101,00	106,00

TOOLS

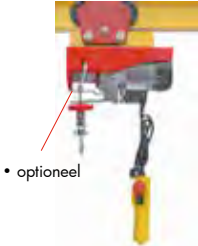

• optioneel

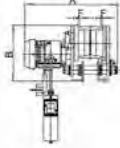

NEW

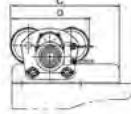

Elektrische trolley voor takels.

Deze trolley rijdt heen en weer in een stalen H of I balk, en onderaan wordt een takel bevestigd.

Voordelen:

- Beweegt de takel zonder inspanning
- Blokkeert de takel volledig bij stilstand
- 100% veiligheid
- Passend op meerdere types stalen balken

Geschikt voor:

- Elektrische takels
- Manuele takels
- Ketting takels

Order nr. 758592527 €

Algemeen			HNRET1T
Orig. nr.			HNRET1T
Nominale capaciteit	t		1
Spanning	V		230
Frequentie	Hz		50
Ingangsvermogen	W		180/220
Verplaatsingsnelheid	m/min		15/16,4
Min. straal in geval van gebogen rail	m		1
Aanbevolen railbreedte	mm		68-110
Afmetingen			
A	mm		301
B	mm		178
C	mm		350
D	mm		253
F	mm		5
Gewicht	kg		14,50
Afmetingen (l x b x h)	mm		350 x 300 x 220
Prijs	€		129,00

Unicraft

NEW



Elektrische takel 30 meter met automatische kabelgeleiding.

Kenmerken:

- Speciaal oprolsysteem voor strak oprollen van de kabel
- Voorkomt knopen en schade aan de kabel
- Verhoogt veiligheid van gebruikers
- Langere levensduur van de motor
- Direct ophangen aan oog, geen moeilijke montage
- 400 kg capaciteit in normaal gebruik
- 800 kg capaciteit in dubbel gebruik met katrol

Order nr. 716199800 €

Orig. nr.		ESW800
Spanning	V	230
Vermogen motor	kW	1,3
Capaciteit dubbel	kg	800
Capaciteit enkel	kg	400
Hefhoogte enkel	m	30
Hefhoogte dubbel	m	15
Kabeldikte	mm	5
Gewicht	kg	32,00
Afmetingen (l x b x h)	mm	510 x 410 x 455
Prijs	€	499,00

Permanente hefmagneten

Unicraft



Hefmagneet voor bevestiging aan takels, katrollen, rolbruggen, enz.

Kenmerken:

- Mechanisch instelbaar voor eenvoudig aankoppelen van werkstukken aan takels of hefbruggen.
- CE-conform.

Geschikt voor:

- Montage van steeledek dakplaten.
- Vervangen van matrijzen of klauwplaten.
- Montage op de werf.
- ...

Order nr.	Orig. nr.	Capaciteit	Ge- wicht	Afmetingen (l x b x h)	Prijs
		t	kg	mm	€
716170001 €	PLM100	0,1	2,80	130 x 60 x 120	172,00
716170003 €	PLM300	0,3	11,00	210 x 95 x 180	331,00
716170006 €	PLM600	0,6	17,50	265 x 115 x 220	545,00
716170010 €	PLM1000	1,0	37,50	325 x 145 x 250	1.155,00

EQUIPMENT

Rails & sjobanden voor rails



Bevestigingsrail BARAIL in staal met rechte openingen voor sjobanden PBL SJ of PBL SZ en ronde voor stootbaar BAST24.

Order nr.	751981001	751987013
Orig. nr.	BARAIL1M	BARAIL3MPR
Lengte mm	1000	3000
Prijs	€ 18,50	50,50



Sjoband PBL SJ met ratel passend op de bevestigingsrail type BARAIL. Set bestaande uit ratel met band en eindfitting. Leverbaar per 1 of 5 stuks.

Order nr.	Orig. nr.	Lengte	Breedte	Capaciteit LC bij recht gebruik	Capaciteit LC bij gebruik in omsnoering	VE	Prijs/VE
		m	mm	daN	daN		€
751985181	PBL SJ20	2	55	500	1000	1	11,50
751985191	PBL SJ30	3	55	500	1000	1	12,50
751985200	PBL SJ40	4	55	500	1000	1	13,50
751985201	PBL SJ50	5	55	500	1000	1	14,90
751985182	PBL SJ20S	2	55	500	1000	5	61,50
751985192	PBL SJ30S	3	55	500	1000	5	64,50
751985202	PBL SJ40S	4	55	500	1000	5	64,50
751985204	PBL SJ50S	5	55	500	1000	5	74,50



Sjoband PBL SZ met buckle-sluiting passend op de bevestigingsrail type BARAIL.

Order nr.	757570020	757570050
Orig. nr.	PBL SZ20	PBL SZ50
Lengte	m 2	5
Capaciteit klemgesp	kg 1500	1500
Capaciteit band	kg 1400	1400
Prijs	€ 31,50	34,50



Set van 4 musketons voor rails type BARAIL. Cap. 1850kg.

Order nr.	751987032
Orig. nr.	BAM600
Capaciteit	kg 1850
Prijs	€ 19,50



Stalen ronde stootbalk. Met geveerd vergrendelingsysteem. Eenvoudig en vlug te ontgrendelen. Hiermee kan u materiaal vastmaken of blokkeren. Wordt enkel staand gebruikt. Gewicht: 7,5 kg. In combinatie met rail BARAIL te gebruiken.

Order nr.	940001239
Orig. nr.	BAST24
Lengte	mm 2263-2006
Diameter	mm 58
Diameter aansluiting	mm ø 24
Prijs	€ 55,50



Bevestigingsrail in aluminium. Geschikt voor opbouw montage.

Te gebruiken in combinatie met volgende items :

- musketons BAM400
- sjoband 2,5m BAS025A of sjoband 5m BAS050A
- stootbaar BAST20

Order nr.	751987025
Orig. nr.	BARA25A
Lengte	mm 3000
Diameter aansluiting	mm 20
Prijs	€ 62,50



Bevestigingsrail in aluminium. Geschikt voor verzonken montage. Te gebruiken in combinatie met volgende items : - musketons BAM400 - sjoband 2,5m BAS025A of sjoband 5m BAS050A - stootbaar BAST20

Order nr.	751987026
Orig. nr.	BARA25B
Lengte	mm 3000
Diameter aansluiting	mm 20
Prijs	€ 62,50



Complete set van aluminiumrail met 4 verplaatsbare musketons en sjoband 2,5m. Bij de rails heeft u keuze uit een model voor opbouw (type A) of inbouw (type B).

Order nr.	751987029	751987030
Orig. nr.	BAM25AS	BAM25BS
Omschrijving	set rail BARA25A + 4 musketons en sjoband	set rail BARA25B + 4 musketons en sjoband
Lengte rail	mm 3000	2540
Prijs	€ 70,90	70,90



Set van 2 korte rails type B van 120mm en 2 musketons. Klaar voor gebruik. Geleverd met bevestigingsaccessoires.

Order nr.	751987010
Orig. nr.	BAMS22
Lengte	mm 2 x 120
Capaciteit	kg 450
Prijs	€ 26,50



Set van 4 musketons voor rails BARA25A en BARA25B. Cap. 1500kg. Te gebruiken in combinatie met volgende items : - ALU rail BARA25A of ALU rail BARA25B - sjoband 2,5m BAS025A of sjoband 5m BAS050A

Order nr.	751987028
Orig. nr.	BAM400
Capaciteit	kg 1500
Prijs	€ 10,90



Sjorband met buckle-sluiting. Verpakt op blister. Geschikt voor rails BARA25A en BARA25B.

Order nr.	75752525	75755050
Orig. nr.	BAS025A	BAS050A
Lengte	m 2,5	5,0
Breedte	mm 25	25
Capaciteit (LC)	daN 100	100
Capaciteit (SHF)	daN 50	50
Prijs	€ 7,00	4,50



Ronde stootbaar geschikt voor rails van type BARA25A en BARA25B. Dit stevige stalen steunpunt is ideaal om machines, goederen, etc. veilig vast te sjobanden in vrachtwagens of bestelwagens. Vastklemming gebeurt met een veer. Zowel horizontaal als verticaal bruikbaar.

Order nr.	751987023
Orig. nr.	BAST20
Lengte	mm 2006-2362
Diameter	mm 38
Diameter aansluiting	mm 20
Prijs	€ 50,50

Sjorbanden



Sjorband met ratel en 2 S-haken.

Order nr.	757571212
Orig. nr.	BAS12A
Lengte	m 5
Breedte	mm 25
Prijs	€ 10,50



Sjorband met ratel en 2 J-haken. Vrachtgordel 35 mm - 1 kort stuk lengte 0,3 m met ratelspanner en stalen J-haak. Sjorband lengte 6 m. Gekeurd.

Order nr.	757571150
Orig. nr.	BAS115B
Lengte	m 6,0 + 0,3
Breedte	mm 35
Capaciteit LC bij recht gebruik	daN 1250
Capaciteit LC bij gebruik in omsnoering	daN 2500
Capaciteit STF	daN 150
Prijs	€ 8,70

TOOLS



Vrachtgordel 50 mm - 1 kort stuk lengte 0,5 m met ratspanner met lange en brede greep en stalen J-haak. Sjorband lengte 9 m. Gekeurd.

Order nr.	75757151	
Orig. nr.	BAPCL51S	
Lengte	m	9,0 + 0,5
Breedte	mm	50
Capaciteit LC bij recht gebruik	daN	2500
Capaciteit LC bij gebruik in omsnoering	daN	5000
Capaciteit STF	daN	300
Prijs	€	14,50

TOOLS



PP-bindband voor uiteenlopend gebruik en dito kunststof strap. Ideaal voor verpakkingsdoeleinden. Rol van 2200m.

Order nr.	757571000	
Orig. nr.	PR-W1	
Lengte	m	2200
Breedte	mm	15
Prijs	€	128,10

TOOLS



Straps voor PP-bindband verpakt per 250 st. VE = verpakkingseenheid.

Order nr.	757571010	
Orig. nr.	757571010	
VE	1	
Min. bestelhoeveelheid	4	
Prijs/VE	€	77,90

TENGOOLS



NEW

Kabelbinder pistool voor het vastzetten van kabelbinders,

Voor kunststof kabelbinders met een breedte van 2,2 tot 4,8 mm. Met automatische snijfunctie. Instelbare treksterkte.

Order nr.	237880109	
Orig. nr.	CTG01	
Capaciteit	mm	2,2-4,8
Prijs	€	22,80

Zuignappen

TENGOOLS



NEW

Zuignap voor het eenvoudig optillen van gladde vlakke materialen, zoals glas, marmer, enz. Zuignap 118 mm diameter.

Order nr.	237760103	
Orig. nr.	SL01	
Aantal zuignappen	1	
Maximale belasting	kg	30
Diameter	mm	118
Gewicht	kg	0,34
Afmetingen (l x b x h)	mm	118 x 118 x 110
Prijs	€	31,40

TENGOOLS



NEW

Tweevoudige zuignap voor het eenvoudig optillen van gladde vlakke materialen, zoals glas, marmer, enz. Zuignappen 118 mm diameter.

Order nr.	237760202	
Orig. nr.	SL02	
Aantal zuignappen	2	
Maximale belasting	kg	60
Diameter	mm	118
Gewicht	kg	0,71
Afmetingen (l x b x h)	mm	118 x 330 x 75
Prijs	€	37,00

TENGOOLS



NEW

Drievoudige zuignap voor het eenvoudig optillen van gladde vlakke materialen, zoals glas, marmer, enz. Zuignappen 118 mm diameter.

Order nr.	237760301	
Orig. nr.	SL03	
Aantal zuignappen	3	
Maximale belasting	kg	120
Diameter	mm	118
Gewicht	kg	1,10
Afmetingen (l x b x h)	mm	330 x 330 x 75
Prijs	€	55,00



W www.vtc.be

🛒 www.vtc.be/webshop

f fb.me/vtc.inrichting.bestelwagen

vtc[®]

**INRICHTING VAN
BEDRIJFSVOERTUIGEN**
LICHT, STERK & MODULAIR



Jerrycans



Kunststof jerrycan met flexibele tuit. UN gehomologeerd. Niet geschikt voor levensmiddelen. VE = verpakkingseenheid.

Order nr.	756000510	756001006	756002006
Orig. nr.	JERRY5R	JERRY10R	JERRY20R
Capaciteit	5	10	20
VE	10	6	6
Prijs/VE	€ 76,90	67,90	112,00



Kunststof jerrycan met kraan. Inhoud 10lt. Niet geschikt voor levensmiddelen. Past in jerrycanhouder PTNC10.

Order nr.	815610018
Orig. nr.	TC10L
Prijs	€ 24,50



Jerrycanhouder. In gelakt ijzer. Geschikt voor TC10L.

Order nr.	815610008
Orig. nr.	PTNC10
Prijs	€ 81,50



Jerrycanhouder. In gelakt ijzer. Geschikt voor JERRY20M.

Order nr.	815610009
Orig. nr.	PTNC20
Prijs	€ 101,00

Papierrollhouders



Papierrollhouder geleverd met of zonder papierrol. In gelakt metaal en voorzien van een systeem ter voorkoming van ongewenst afrollen van het papier. Leverbaar in 2 modellen.

Order nr.	940014014	940014015	940014016	940014017
Orig. nr.	PC250E	PC250ES	PC280E	PC280ES
Omschrijving	papierrollhouder in alu MET papierrol	papierrollhouder in alu ZONDER papierrol	papierrollhouder in alu MET papierrol	papierrollhouder in alu ZONDER papierrol
Gewicht	kg 1,36	0,69	4,41	1,28
Afmetingen (l x b x h)	mm 240 x 90 x 150	240 x 90 x 150	280 x 160 x 210	280 x 160 x 210
Prijs	€ 69,50	58,90	82,90	67,50



Papierrol apart voor PC250 en PC280.

Order nr.	940001010	815610099
Orig. nr.	CR250	CR280
Voor type	PC250	PC280
Gewicht	kg 0,67	3,14
Afmetingen (l x b x h)	mm 220 x 190 x 0	250 x 250 x 0
Prijs	€ 10,50	26,90



Metalen papierrollhouder. Muurmodel. Gepoederlakt. Geleverd zonder papierrol.

Order nr.	758621001
Orig. nr.	SHC004
Diameter rol	mm 300
Afmetingen (l x b x h)	mm 500 x 336 x 635
Prijs	€ 31,50



Metalen papierrollhouder. Voetmodel. Gepoederlakt. Geleverd zonder papierrol.

Order nr.	758621400
Orig. nr.	SHC014
Diameter rol	mm 300
Afmetingen (l x b x h)	mm 700 x 480 x 770
Prijs	€ 43,90

Montagestoelen

TOOLS



Montageligbed.

Kenmerken:

- Vast model.
- Uit harde kunststof.
- Met zachte hoofdsteun.
- Wielen in zwart pvc met zachtlopende grijze PU-laag.

Order nr.	756203002 €	
Orig. nr.	MTB10	
Minimum hoogte	mm	50
Maximum hoogte	mm	115
Diameter wiel	mm	75
Maximum laadcapaciteit	kg	130
Gewicht	kg	4,80
Afmetingen (l x b x h)	mm	1010 x 490 x 120
Prijs	€	41,50

TOOLS



Werkplaatsstoel/plooibaar montageligbed

Kenmerken:

- PP wielen met schokabsorberende PE-laag
- **Oplooibaar in 3 delen** van ligbed tot werkplaatsstoel
- Comfortabele, moussens matras
- Gemakkelijk te reinigen
- Uit PVC

Order nr.	756203001 €	
Orig. nr.	MTB3D	
Minimum hoogte	mm	105
Maximum hoogte	mm	470
Diameter wiel	mm	60
Maximum laadcapaciteit	kg	110
Gewicht	kg	6,70
Afmetingen (l x b x h)	mm	1020 x 400 x 470
Prijs	€	67,90

TOOLS



Werkplaatsstoel.

Kenmerken:

- Op 5 PU-wielen.
- Verstelbaar in de hoogte met cilinder.
- Met magneetvakje in de basis.

Order nr.	756183650 €	
Orig. nr.	MS365	
Minimum hoogte	mm	440
Maximum hoogte	mm	555
Diameter zijje	mm	365
Diameter basis	mm	440
Gewicht	kg	6,60
Afmetingen (l x b x h)	mm	365 x 365 x 440
Prijs	€	58,90

Motorstands

TOOLS



Motorsteun.

Kenmerken:

- Met 360° draaibare kop
- klikt vast in 8 posities.

Order nr.	758621600 €	
Orig. nr.	CAT1000	
Capaciteit	kg	450
Gewicht	kg	21,00
Afmetingen (l x b x h)	mm	750 x 850 x 900
Prijs	€	82,50

EQUIPMENT

Oprolhaspels



Stevige automatische oprolhaspel voor perslucht.

Kenmerken:

- Behuizing in polypropyleen.
- Slang in soepele pvc.
- 180° links-rechts beweegbaar op muurbevestiging.
- Met kabelgeleiding dmv boven- en onderrol.
- Op- en afrolbaar met een klikmechanisme.
- Automatische terugkeer door kort aantrekken.
- Werktemperatuur: 0° tot 60°C.

Order nr.	756200705 €	
Orig. nr.	HAL00808	
Lengte kabel	m	7 + 0,6
Muurbevestiging	✓	
Diameter inwendig	mm	8
Aansluiting	inch	1/4
Maximum druk	bar	12
Kwaliteit kabel	PVC	
Gewicht	kg	4,00
Afmetingen (l x b x h)	mm	310 x 145 x 300
Prijs	€	59,90



Stevige automatische oprolhaspel voor perslucht.

Kenmerken:

- Behuizing in polypropyleen.
- Slang in soepele pvc.
- 180° links-rechts beweegbaar op muurbevestiging.
- Met kabelgeleiding dmv boven- en onderrol.
- Op- en afrolbaar met een klikmechanisme.
- Automatische terugkeer door kort aantrekken.
- Werktemperatuur: 0° tot 60°C.

Order nr.	756200707 €	
Orig. nr.	HAL01015	
Lengte kabel	m	15 + 0,5
Muurbevestiging	✓	
Aansluiting	inch	3/8
Maximum druk	bar	20
Inwendige diameter leiding	mm	10
Kwaliteit kabel	PVC	
Kabelgeleiding	✓	
Gewicht	kg	9,00
Afmetingen (l x b x h)	mm	410 x 200 x 400
Prijs	€	97,90



Stevige automatische oprolhaspel voor perslucht.

Kenmerken:

- Behuizing in polypropyleen.
- Slang in soepele pvc.
- 180° links-rechts beweegbaar op muurbevestiging.
- Met kabelgeleiding dmv boven- en onderrol.
- Op- en afrolbaar met een klikmechanisme.
- Automatische terugkeer door kort aantrekken.
- Werktemperatuur: 0° tot 60°C.

Order nr.	756200720 €	
Orig. nr.	HAL03820	
Lengte kabel	m	20 + 0,5
Muurbevestiging	✓	
Aansluiting	inch	3/8
Maximum druk	bar	20
Inwendige diameter leiding	mm	10
Kwaliteit kabel	PVC	
Kabelgeleiding	✓	
Gewicht	kg	9,00
Afmetingen (l x b x h)	mm	460 x 215 x 430
Prijs	€	109,00



Stevige automatische oprolhaspel voor perslucht.

Kenmerken:

- **Groot luchtdebiet** door 13mm slangdiameter (binnendiameter) en 1/2" aansluiting.
- Behuizing in impactbestendig polypropyleen.
- Sterke, soepele HPM Slang met uniek gebruiksgemak.
- 180° links-rechts beweegbaar op muurbeugel.
- Slanggeleiding dmv boven- en onderrol.
- Op- en afrolbaar met een klikmechanisme.
- Automatische terugkeer door kort aantrekken.
- Werktemperatuur: -10° tot 60°C.

Unieke voordelen van de HPM-slang:

- Combineert voordelen van PVC en rubber in 1 product:
- 1. Superieure buigkracht voorkomt kreuken.
- Resistent tegen olie, warmte, ozon en schuren.
- Ook in koude omstandigheden nog flexibel.
- Rolt af zonder te krullen.
- Heel licht.
- Werktemperatuur: -10°C tot 60°C

Order nr.	756200745 €	
Orig. nr.	HAL01215	
Lengte kabel	m	15 + 0,5
Muurbevestiging	✓	
Diameter inwendig	mm	13
Aansluiting	inch	1/2
Maximum druk	bar	20
Kwaliteit kabel	HPM	
Gewicht	kg	10,00
Afmetingen (l x b x h)	mm	420 x 230 x 490
Prijs	€	126,00

TOOLS



NEW

Automatische slanghaspel voor perslucht, met slanggeleiding.

Kenmerken:

- **unieke slanggeleiding**, rolt altijd soepel en geordend op.
- **Snelheidsbegrenzing**, geen ongevallen door snel terugslaan de slang
- Soepele en sterke PVC luchtslang
- Behuizing in stevig polypropyleen
- 180° draaibaar op muurbevestiging
- Klikmechanisme: de slang kan op ieder punt gestopt worden
- Automatische terugkeer door kort aantrekken
- Behuizing met handvat voor eventuele verplaatsingen
- **2 meter lange aansluitslang** laat toe de haspel ver van de aansluiting te monteren.

Order nr.	756200725 [€]	
Orig. nr.	HAL03820CG	
Lengte kabel	m	20 + 2
Muurbevestiging		✓
Diameter inwendig	mm	10
Aansluiting	inch	3/8
Maximum druk	bar	17
Kwaliteit kabel		PVC
Kabelgeleiding		✓
Snelheidscontrole		✓
Gewicht	kg	9,10
Afmetingen (l x b x h)	mm	445 x 265 x 625
Prijs	€	119,00

TOOLS



HPM

Vaste, automatische slanghaspel voor perslucht.

Montage op muur, plafond of vloer.

Kenmerken:

- Basis en kabelgeleiding in staal.
- 15m HPM slang
- Drum in stevig PVC.
- Open haspel met automatische retour van de slang.
- Geleiding instelbaar in 3 posities voor optimale plaatsing.
- 3/8" in- en uitgang.
- Voorzien van aansluitslang van 0,9m.

Voordelen van de HPM-slang:

- Combineert voordelen van PVC en rubber in 1 uniek product:
- Superieure buigkracht voorkomt kreuken.
- Resistent tegen olie, warmte, ozon en schuren.
- Ook in koude omstandigheden nog flexibel.
- Rolt af zonder te krullen.
- Heel licht.
- Werktemperatuur: -10°C -60°C.

Order nr.	756200735 [€]	
Orig. nr.	HAL03815V	
Lengte kabel	m	15 + 0,9
Muurbevestiging		✓
Aansluiting	inch	3/8
Maximum druk	bar	20
Inwendige diameter leiding	mm	10
Kwaliteit kabel		HPM
Kabelgeleiding		✓
Gewicht	kg	7,50
Afmetingen (l x b x h)	mm	365 x 175 x 539
Prijs	€	85,50

TOOLS



HPM



Manuele oprolhaspel voor perslucht.

Kenmerken:

- Metalen behuizing.
- Unieke HPM slang van 30 meter.
- Slangblokkering.
- Oprolhendel.
- Draaibaar plateau.

Voordelen van de HPM-slang:

- Combineert voordelen van PVC en rubber in 1 uniek product:
- Superieure buigkracht voorkomt kreuken.
- Resistent tegen olie, warmte, ozon en schuren.
- Ook in koude omstandigheden nog flexibel.
- Rolt af zonder te krullen.
- Heel licht.
- Werktemperatuur: -10°C -60°C

Order nr.	756200730 €	
Orig. nr.	HAL01430M	
Lengte kabel	m	30 + 1,1
Aansluiting	inch	1/4
Maximum druk	bar	12
Inwendige diameter leiding	mm	8
Kwaliteit kabel	HPM	
Gewicht	kg	10,00
Afmetingen (l x b x h)	mm	330 x 300 x 370
Prijs	€	90,90

aircraft

PU



Automatische oprolhaspel voor perslucht.

Kenmerken:

- 15 meter vezelversterkte PU-slang.
- Behuizing in polypropyleen.
- 180° links-rechts beweegbaar op muurbevestiging.
- Op- en afrolbaar met een klikmechanisme.
- Automatische terugkeer door kort aantrekken.
- Werktemperatuur : -5° tot 40°C.

Order nr.	712105200 €	
Orig. nr.	SARI0/15PRO	
Lengte kabel	m	15 + 1
Muurbevestiging	✓	
Diameter inwendig	mm	10
Aansluiting	inch	3/8
Maximum druk	bar	15
Inwendige diameter leiding	mm	10
Kwaliteit kabel	PU	
Ingang/uitgang	inch	3/8
Maximum luchtverbruik	bar	15
Werktemperatuur	°C	-5 - +40
Gewicht	kg	6,50
Afmetingen (l x b x h)	mm	230 x 420 x 490
Prijs	€	245,00

TOOLS



**ELECTRIC
230 V**

Automatische kabelhaspel met elektriciteitskabel

Kenmerken:

- Behuizing in onbreekbaar polypropyleen.
- Geleverd met 2 stekkers.
- Flexibele rubberkabel HN07RN-F die weer-, vet- en oliebestendig is (conform de CEI 20-35 norm).
- Op 180° links-rechts beweegbare muurbevestiging.
- Met kabelbegeleiding dmv boven- en onderrol.
- Op- en afrolbaar met een klikmechanisme.
- Automatische terugkeer door kort aantrekken.
- Met thermische beveiliging.
- CE en IP42 conform.
- Met Schuko-combi strekker.

Order nr.	756200625 €	
Orig. nr.	HAE31508	
Lengte kabel	m	8 + 1
Spanning	V	230
Toegelaten vermogen opgerold	W	1000
Toegelaten vermogen ontrol	W	2000
Kabel	mm ²	3x1,5
Muurbevestiging	✓	
Certificaat	VDE, GS, CE	
Gewicht	kg	4,50
Afmetingen (l x b x h)	mm	280 x 160 x 305
Prijs	€	61,90

TOOLS



NEW

Compacte muurhaspel voor elektrische kabel 1,5 mm², lengte 8m.

Kenmerken:

- Kabelgeleiding binnenin met tandwielkast. Altijd perfect opgerold
- Blokkeerknop voor extra veiligheid
- Rubberkabel HN07RN-F, water-, vet- en oliebestendig (conform de CEI 20-35 norm)
- Op 180° links-rechts beweegbare muurbevestiging
- Geleverd met stekkers met rand- en penaarnding
- Op- en afrolbaar met klikmechanisme
- Automatische terugkeer door kort aantrekken
- Thermische beveiliging
- CE en IP42 conform
- Behuizing uit onbreekbaar polypropyleen

Order nr.	756200632 €	
Orig. nr.	HAE31508N	
Lengte kabel	m	8+1
Spanning	V	230
Toegelaten vermogen opgerold	W	1000
Toegelaten vermogen ontrol	W	2400
Kabel	mm ²	3x1,5
Kabelgeleiding	✓	
Gewicht	kg	4,50
Afmetingen (l x b x h)	mm	295 x 165 x 330
Prijs	€	61,90



Compacte muurhaspel voor elektrische kabel **2,5 mm²**, lengte 8 m.

Kenmerken:

- Kabelgeleiding binnenin met tandwielkast. Altijd perfect opgerold
- Blokkeerknop voor extra veiligheid
- Rubberkabel HN07RN-F, water-, vet- en oliebestendig (conform de CEI 20-35 norm)
- Op 180° links-rechts beweegbare muurbevestiging
- Geleverd met stekkers met rand- en penarding
- Op- en afrolbaar met klikmechanisme
- Automatische terugkeer door kort aantrekken
- Thermische beveiliging
- CE en IP42 conform
- Behuizing uit onbreekbaar polypropyleen

Order nr.	756200634 €	
Orig. nr.	HAE32508N	
Lengte kabel	m	8+1
Spanning	V	230
Toegelaten vermogen opgerold	W	1600
Toegelaten vermogen ontroll	W	3200
Kabel	mm ²	3x2,5
Kabelgeleiding		✓
Gewicht	kg	4,50
Afmetingen (l x b x h)	mm	295 x 165 x 330
Prijs	€	69,90



Compacte muurhaspel voor elektrische kabel **1,5 mm²**, lengte 14 m.

Kenmerken:

- Kabelgeleiding binnenin met tandwielkast. Altijd perfect opgerold
- Blokkeerknop voor extra veiligheid
- Rubberkabel HN07RN-F, water-, vet- en oliebestendig (conform de CEI 20-35 norm)
- Op 180° links-rechts beweegbare muurbevestiging
- Geleverd met stekkers met rand- en penarding
- Op- en afrolbaar met klikmechanisme
- Automatische terugkeer door kort aantrekken
- Thermische beveiliging
- CE en IP42 conform
- Behuizing uit onbreekbaar polypropyleen

Order nr.	756200638 €	
Orig. nr.	HAE31514N	
Lengte kabel	m	14+1
Spanning	V	230
Toegelaten vermogen opgerold	W	1000
Toegelaten vermogen ontroll	W	2400
Kabel	mm ²	3x1,5
Kabelgeleiding		✓
Gewicht	kg	5,80
Afmetingen (l x b x h)	mm	295 x 165 x 330
Prijs	€	89,90



Automatische kabelhaspel met elektriciteitskabel.

Kenmerken:

- Behuizing in onbreekbaar polypropyleen.
- Flexibele rubberkabel HN07RN-F die weer-, vet- en oliebestendig is (conform de CEI 20-35 norm).
- Flexibele kabel, die weer-, vet- en oliebestendig is.
- Op 180° links-rechts beweegbare muurbevestiging.
- Met kabelbegeleiding dmv boven- en onderrol.
- Op- en afrolbaar met een klikmechanisme.
- Automatische terugkeer door kort aantrekken.
- Met thermische beveiliging.
- CE en IP42 conform.

Geleverd met 2 stekkers. Met Schuko-combi strekker.

Order nr.	756200620 €	
Orig. nr.	HAE31520	
Lengte kabel	m	20 + 1
Spanning	V	230
Toegelaten vermogen opgerold	W	1000
Toegelaten vermogen ontroll	W	2000
Kabel	mm ²	3x1,5
Muurbevestiging		✓
Certificaat		VDE, GS, CE
Gewicht	kg	6,50
Afmetingen (l x b x h)	mm	385 x 165 x 315
Prijs	€	119,00



Automatische kabelhaspel met elektriciteitskabel.

Kenmerken:

- Behuizing in onbreekbaar polypropyleen.
- Flexibele rubberkabel HN07RN-F die weer-, vet- en oliebestendig is (conform de CEI 20-35 norm).
- Op 180° links-rechts beweegbare muurbevestiging.
- Met kabelbegeleiding dmv boven- en onderrol.
- Op- en afrolbaar met een klikmechanisme.
- Automatische terugkeer door kort aantrekken.
- Met thermische beveiliging.
- CE en IP42 conform.

Geleverd met 2 stekkers. Met Schuko-combi strekker.

Order nr.	756202520 €	
Orig. nr.	HAE32520	
Lengte kabel	m	20 + 1
Spanning	V	230
Toegelaten vermogen opgerold	W	1600
Toegelaten vermogen ontroll	W	3200
Kabel	mm ²	3x2,5
Muurbevestiging		✓
Certificaat		VDE, GS, CE
Gewicht	kg	10,00
Afmetingen (l x b x h)	mm	450 x 210 x 440
Prijs	€	174,00

TOOLS

ELECTRIC
230 V



Draagbare kabelhaspel met unieke automatische oprolfunctie.

Kenmerken:

- Uw verlengkabel ligt nooit meer in de weg, maar wordt steeds teruggerold op de haspel.
- Met kabelblokkering, thermische beveiliging en slagvast behuizing.
- Perfecte kabelgeleiding.
- Flexibele rubberkabel H07RN-F die weer-, vet- en oliebestendig is.
- Regenwaterdicht.
- Antislipvoeten op 6 plaatsen.
- Ideaal voor op de werf.
- EN 61 242, VDE, KEMA, CEBC.
- Met Schuko-combi strekker.

Order nr.	756200630	
Orig. nr.	HAE31520MO	
Lengte kabel	m	17 + 3
Spanning	V	230
Toegelaten vermogen opgerold	W	720
Toegelaten vermogen ontrol	W	3120
Kabel	mm ²	3x1,5
Certificaat	VDE, GS, CE	
Gewicht	kg	6,00
Afmetingen (l x b x h)	mm	500 x 310 x 290
Prijs	€	82,00

aircraft



Verdeelbox voor druklucht en elektriciteit.

Kenmerken:

- Geschikt voor mobiel gebruik op de grond of in de lucht op de gewenste hoogte.
- Stof-en waterdicht IP44
- Handgreep/werkuighaak
- 3 m messingketting
- 3 m H07RNF rubber-neopreen kabel
- 3 m drukluftslang 9 mm

Order nr.	712100001	712100002
Orig. nr.	A-EA1	A-EA2
Lengte kabel	m	3
Spanning	V	230-400
Kabel	mm ²	1,5
Lengte slang	m	3
Muurbevestiging	✓	✓
Lengte	m	3
Luchtdrukaansluiting	1 EURO	1 EURO
Gewicht	kg	2,40
Prijs	€	69,90
		95,90

TOOLS

HPM

WATER

- Automatische kabelbegleiding met snelheidscontrole



Professionele, stevige automatische oprolhaspel voor water.

Kenmerken:

- Behuizing in polypropyleen.
- Slang in soepele PVC.
- 180° links-rechts beweegbaar op muurbevestiging.
- Op- en afrolbaar met klikmechanisme.
- De slang kan op ieder punt gestopt worden.
- Automatische terugkeer door kort aantrekken.
- Met automatische kabelbegeleiding (d.m.v. rail) en snelheidsbegrenzing, zodat de slang veilig, gelijkmatig en op een geordende manier in de behuizing opgerold wordt.
- Met spuitkop.

Order nr.	756200808	
Orig. nr.	HAW01220	
Lengte slang	m	20
Muurbevestiging		✓
Diameter inwendig	mm	13
Aansluiting	inch	3/4
Maximum druk	bar	10
Kwaliteit kabel		PVC
Kabelgeleiding		✓
Snelheidscontrole		✓
Gewicht	kg	9,10
Afmetingen (l x b x h)	mm	510 x 275 x 470
Prijs	€	99,00

Blikkenpersen



Pneumatische pers voor blikken.

Geschikt voor:

- Blikken tot 30 l

Geleverd met:

- ATEX/VEXAT certificaat voor ATEX Zone II 3G

Order nr.	754720009 €		
Orig. nr.	RPP30		
Benodigde luchtdruk	bar	8	
Drukracht	kg	1600	
Afmetingen kamer	mm	370x350x580	
Gewicht	kg	95,00	
Afmetingen (l x b x h)	mm	500 x 450 x 1780	
Prijs	€	1.799,00	



Pneumatische pers voor papier, karton en blikken

Geschikt voor:

- Papier
- Karton
- Blikken tot 30 l

Geleverd met:

- Inclusief ATEX/VEXAT certificaat voor ATEX Zone II 3G

Order nr.	754720010 €		
Orig. nr.	RPP201		
Benodigde luchtdruk	bar	8	
Drukracht	kg	980	
Afmetingen kamer	mm	700x450x770	
Afmetingen laadklep	mm	720x310	
Voor balen	kg	30	
Gewicht	kg	200,00	
Afmetingen (l x b x h)	mm	850 x 500 x 1660	
Prijs	€	2.769,00	

Garagestands



Set van 2 garagestands.

Kenmerken:

- Capaciteit van 3, 6 of 12 ton.
- Model met tandlat.



Opmerking: Model 12 t is enkel geschikt voor export buiten de EU.

Order nr.	754753030 €	754756060 €	754751212 €	
Orig. nr.	CAGS3T	CAGS6T	CAGS12T	
Capaciteit	t	3	6	12
Hoogte minimum	mm	288	406	468
Hoogte maximum	mm	425	629	715
Voet	mm	190x216	254x292	305x317
Tandlat	mm	267x100	366x120	467x162
Gewicht	kg	8,50	13,90	30,00
Prijs	€	29,00	56,90	108,00



Professionele zware garagestand.

Kenmerken:

- Capaciteit van 25 ton.
- Met versterkte kolom en grote, stabiele grondplaat.
- CNC-gedraaide glij-as met matzwarte krasbestendige afwerking.
- Precisie borgpen met 2 inlegsleuven en veiligheidsketting.
- Met handgreep.



Geleverd per stuk.

Order nr.	754751227 €		
Orig. nr.	CAGS25T		
Capaciteit	t	25	
Hoogte minimum	mm	415	
Hoogte maximum	mm	640	
Gewicht	kg	23,50	
Afmetingen (l x b x h)	mm	38 x 380 x 440	
Prijs	€	133,00	



Professionele zware garagestand.

Kenmerken:

- Capaciteit van 25 ton
- Extra groot werkbereik
- Met versterkte kolom en grote, stabiele grondplaat
- CNC-gedraaide glij-as met matzwarte krasbestendige afwerking
- Precisie borgpen met 2 inlegsleuven en veiligheidsketting
- Met handgreep



Geleverd per stuk.

Order nr.	754751225 €		
Orig. nr.	CAGS25TH		
Capaciteit	t	25	
Hoogte minimum	mm	675	
Hoogte maximum	mm	1050	
Gewicht	kg	33,50	
Afmetingen (l x b x h)	mm	380 x 380 x 710	
Prijs	€	201,00	

Olieopvang

TOOLS



Olieopvangpan 15 liter.

Order nr.	724561004 €
Orig. nr.	ODP15
Gewicht	kg 1,20
Afmetingen (l x b x h)	mm 560 x 480 x 460
Prijs	€ 14,90

TOOLS

30L



Olieopvang unit op wielen.

Kenmerken:

- Capaciteit van 30 liter
- Vat uit PE
- Verstelbare hoogte.

Order nr.	724561006 €
Orig. nr.	OD30PE
Capaciteit	l 30
Hoogte minimum	mm 680
Hoogte maximum	mm 1650
Verstelbare hoogte	mm 680-1650
Diameter trechter	mm 420
Gewicht	kg 5,50
Prijs	€ 79,90

TOOLS

68L



Olieopvangunit met pneumatische lediging.

Kenmerken:

- Het vat is heel eenvoudig en proper te ledigen aan de hand van luchtdruk.
- Het oliepeil kan afgelezen worden op het vat.
- Met 2 vaste en 2 zwenkbare wielen voor uitstekende mobiliteit.

Geslacht voor:

- Het afzuigen en tijdelijk opslaan van mechanische smeerolie (max 40-80 °C).

Niet geschikt voor de extractie van remvloeistof, benzine, diesel, ontvlambare en corrosieve vloeistoffen,...

Order nr.	724561001 €
Orig. nr.	OD68
Capaciteit	l 68
Hoogte minimum	mm 1170
Hoogte maximum	mm 1780
Verstelbare hoogte	mm 1170-1780
Diameter trechter	mm 290
Gewicht	kg 23,00
Afmetingen (l x b x h)	mm 960 x 440 x 420
Prijs	€ 179,00

TOOLS



Multifunctionele olie opvang- en afzuigunit met een capaciteit van 65 + 9 liter en een verstelbare hoogte van 130-185cm.

Kenmerken:

- 2 vaste en 2 zwenkwielen voor uitstekende mobiliteit

Twee functies:

1. Olie drainage onder auto
2. Olie afzuigen (bijvoorbeeld uit motorkap)

Geschikt voor:

- Het afzuigen en tijdelijk opslaan van mechanische smeeroilie (max 40-80 °C)

Niet geschikt voor de extractie van remvloeistof, benzine, diesel, ontvlambare en corrosieve vloeistoffen,...

Order nr.	724561003 €		
Orig. nr.		ODC65	
Capaciteit	l	65	
Capaciteit tussenkamer	l	9	
Verstelbare hoogte	mm	1300-1850	
Lengte trechter	mm	530	
Gewicht	kg	24,00	
Afmetingen (l x b x h)	mm	790 x 560 x 540	
Prijs	€	299,00	

TOOLS



Olie-afzuig- en opvangunit met opklapbare trechter en pneumatische lediging. De trechter kan eenvoudig op- en neergeklapt worden.

Kenmerken:

- Het vat is eenvoudig pneumatisch te ledigen
- Het oliepeil kan afgelezen worden op het vat
- Met 2 vaste en 2 zwenkbare wielen op het vat en 4 zwenkwielen op de trechter, voor uitstekende mobiliteit
- Inclusief 6 olieslangen, waardoor dit toestel geschikt is voor verschillende types wagens

2 functies:

- Olie drainage onder auto
- Olie afzuigen

Geschikt voor:

- Het afzuigen en tijdelijk opslaan van mechanische smeeroilie (max 40-80 °C)

Niet geschikt voor de extractie van remvloeistof, benzine, diesel, ontvlambare en corrosieve vloeistoffen,...

Kenmerken meegeleverde slangen:

Materiaal	Diameter (mm)	Lengte (mm)	Extractiesnelheid (l/min)
1. Cu	5	700	1,9
2. Cu	6	700	3,7
3. pvc	5	700	1,0
4. pvc	6	700	2,0
5. pvc	8	700	6,5
6. pvc	7	1000	3,7

Order nr.	724561041 €		
Orig. nr.		ODM80	
Capaciteit tank	l	78	
Hoogte minimum trechter	mm	242	
Hoogte tank	mm	950	
Hoogte maximum	mm	1550	
Capaciteit trechter	l	48	
Afmetingen trechter	mm	735x635x225	
Lengte frame	mm	1310	
Luchttoevoer	bar	6-8	
Consummation d'air	l/min	200	
Aansluiting luchttoevoer	inch	1/4	
Druk voor lediging	bar	0,7-1	
Dimensions externe tuyau d'aspiration	mm	2000x19	
Buitenafmetingen ledegingslang	mm	2000x25	
Temperatuur olie	°C	40-80	
Gewicht	kg	26,00	
Prijs	€	479,00	

Smeergereedschap

TOOLS



OP603-OP605

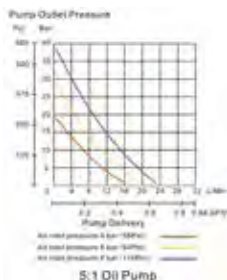

OP2003-2005

NEW
OLIE

Mobiele pneumatische oliepomp voor vaten 60 of 200 liter, aan drukverhouding 3:1 of 5:1.

Eenvoudig te bewegen doorheen de werkplaats.

Geleverd met:

- Pneumatische oliepomp
- Stevige kar op 2 vaste en 2 zwenkwielen
- Afgifteslang 4 m
- Digitaal automatisch oliepistool

Order nr.	724563004	724563001	724563005	724563002
Orig. nr.	OP603	OP605	OP2003	OP2005
Voor vaten	l 20-60	20-60	180-200	180-200
Drukverhouding	3:1	5:1	3:1	5:1
Lengte afgifteslang	m 4	4	4	4
Diameter afgifteslang	inch 1/2	1/2	1/2	1/2
Maximum densiteit olie	SAE 250	250	250	250
Temperatuur olie	°C -10 ~ +50	-10 ~ +50	-10 ~ +50	-10 ~ +50
Maximum druk olie	bar 24	40	24	40
Vermogen oliafgifte	l/min 12-18	12-18	12-18	12-18
Lengte pomp	mm 740	740	940	940
Diameter pomp	mm 34	30	34	30
Werkdruk	bar 5-8	5-8	5-8	5-8
Luchtverbruik	l/min 240	240	240	240
Luchtaansluiting	inch 1/4	1/4	1/4	1/4
Olieuitgang	BSP 1/2"	1/2"	1/2"	1/2"
Gewicht	kg 18,20	18,20	25,60	25,60
Prijs	€ 369,00	369,00	399,00	399,00

TOOLS



VP60

NEW
VET



VP200

Mobiele pneumatische smerunit voor vaten 60 liter of 200 liter. Met volgplaat. Eenvoudig te bewegen doorheen de werkplaats.

Geleverd met:

- Vetpomp
- Stevige kar op 2 vaste en 2 zwenkwielen
- Vatdeksel en volgplaat
- Vetslang 4 m
- Vetpistool en Z-koppeling

Order nr.	724563003	724563006
Orig. nr.	VP60	VP200
Voor vat met diameter	mm 335-360	540-580
Diameter deksel vat	mm 385	600
Diameter volgplaat	mm 370	585
Lengte afgifteslang	m 4	4
Diameter afgifteslang	inch 1/4	1/4
Voor vaten	l 20-60	180-200
Drukverhouding	50:1	50:1
Maximum druk olie	bar 400	400
Vermogen	g/min 600/800	600-800
Lengte aanzuigbuis	mm 480	940
Diameter aanzuigbuis	mm 32	32
Luchtdruk	bar 6-8	6-8
Luchtdrukaansluiting (snelkoppeling)	inch 1/4	1/4
Vetuitgang	BSP 12"	12"
Gewicht	kg 20,80	28,00
Prijs	€ 329,00	369,00

EQUIPMENT



Digitaal oliepijpstool preselect met flexibele uitloop 90°.



Kenmerken:

- Wanneer de vooringestelde hoeveelheid bereikt is, zal de oliemeter automatisch de olietoevoer stoppen.
- Met digitale display: de afgegeven hoeveelheid kan heel precies afgelezen worden.
- Werkt op meegelverde batterij Lithium CR124 3 V/1400 mAh.

Order nr.	724563011 €	
Orig. nr.	OPDMP	
Vermogen	l/min	1:30
Maximum werkdruk	bar	70
Minimum werkdruk	bar	3
Draaikoppeling handvat	inch	1/2
Automatisch drukventiel diameter	mm	10
Gewicht	kg	1,40
Afmetingen (l x b x h)	mm	330 x 140 x 125
Prijs	€	119,00



Pneumatische oliepompen OP.

Order nr.	724563009 €	724563010 €	724563008 €	724563014 €
Orig. nr.	OPP360	OPP560	OPP3200	OPP5200
Voor vaten	l	20-60	20-60	180-200
Drukverhouding		3:01	5:01	3:01
Geleverd bij		OP603	OP605	OP2003
Maximum druk olie	bar	24	40	24
Vermogen oliafgifte	l/min	12-18	12-18	12-18
Lengte pomp	mm	740	740	940
Diameter pomp	mm	34	30	34
Werkdruk	bar	5-8	5-8	5-8
Luchtverbruik	l/min	240	240	240
Luchtaansluiting	inch	1/4	1/4	1/4
Olieuitgang	BSP	1/2"	1/2"	1/2"
Gewicht	kg	5,80	5,80	6,20
Prijs	€	139,00	139,00	139,00



Pneumatische vetpomp 50:1 voor VP60/200.

Order nr.	724563016 €		724563022 €	
Orig. nr.	VPP5060		VPP50200	
Geleverd bij	VP60		VP200	
Voor vaten	l	20-60	180-200	
Drukverhouding		50:1	50:1	
Maximum druk olie	bar	400	400	
Vermogen	g/min	600-800	600-800	
Lengte aanzuigbuis	mm	480	940	
Diameter aanzuigbuis	mm	32	32	
Luchtdruk	bar	6-8	6-8	
Luchtdrukaansluiting (snelkoppeling)	inch	1/4	1/4	
Vetuitgang	BSP	1/2"	1/2"	
Gewicht	kg	4,80	4,80	
Prijs	€	159,00	164,00	



Bijvulapparaat voor vet. Voor een 20 liter tank.

Order nr.	724302020 †	
Orig. nr.	GRSVP20	
Diameter	mm	450
Prijs	€	49,50



Vetspuit met een capaciteit van 400 ml, inclusief vaste spuitpijp. Kan met bulk of patroonvulling gebruikt worden. Voorzien van draad-aansluiting.

Order nr.	724571110 †	
Orig. nr.	GRSPP100	
Capaciteit	ml	400
Prijs	€	20,50



Industriële vetspuit met capaciteit 500 ml. Werkt met standaard 400cc vetpatronen of met vet in bulk. Met draadaansluiting en verwisselbare vulnippel, ontluchtnippel, vaste spuitpijp MCOX1, M10x1 smeernippel 4-klauwen en flexibel. Hoge druk 690 bars. Zwart gelakte uitvoering.

Order nr.	724574040 †	
Orig. nr.	GRSP100FV	
Capaciteit	ml	500
Druk	bar	690
Prijs	€	24,90



Pneumatische vetspuit FPS PRO voor alle standaard 400g DIN vetcartouches, of directvulling manuele voortgang: elke druk op de knop geeft 1 korte luchtstoot. Geleverd met vaste en flexibele nippel.

Order nr.	712102230 †	
Orig. nr.	FPS PRO	
Werkdruk	bar	28
Luchtverbruik	l/slag	0,4
Drukvermogen		1:50
Prijs	€	40,50



Draadloze accu vetspuit 14,4 Volt

Geschikt voor:

- standaard vetpatronen en vetcartridges (400ml) en 500ml bulk.

Kenmerken:

- Debiet: + 90-120 ml/min bij 70 bar
- Maximale belastbare werkdruk 517bar / 7.500 psi
- Laden op drie manieren mogelijk: bulk, cartridge en aanzuiging
- 1 volle accu is 4-5 vetpatronen
- Met display voor status accu
- Met overdrukbeveiliging
- Met ontluchtingsnippel

Set bevat:

- Vetspuit 14,4 volt
- 2 herlaadbare 14,4V 1,7 Ah Ni-Cd batterijen
- Snellader 230V (opladetiijd: 1,5-2 uur)
- Smeerslang met beschermveer 5/32" x 75 cm (geschikt voor hogedruk tot 586 bar)
- Smeerkop
- Geleverd in robuuste kunststof koffer

Order nr.	724574050
Orig. nr.	IU1440
Capaciteit	ml 500
Debiet	l/m 0,09-0,12
Maximum druk	bar 517
Batterij	V 14,4
Batterijen	2
Prijs	€ 149,00



Universeel smeervet. Geschikt voor toepassingen bij hoge temperatuur. Goede weerstand tegen water.

Order nr.	155580103
Orig. nr.	UNIGRE EX 25-400G
Viscositeit bij 40°C	mm ² /s 200
Inhoud	kg 0,4
Prijs	€ 7,40



Universeel smeervet.

Geschikt voor smering van medium tot zwaar belaste rollagers of waar smering met Lithium type vet EP 2 is voorgeschreven. Bruikbaar bij temperaturen tussen -30° en +120°C voor alle mogelijke door SKF-voorgeschreven snelheden. Universeel vet met prima anti-corrosie eigenschappen, waterafscheidend en mechanisch stabiel.

Order nr.	155560204	155560303
Orig. nr.	UNIGREST2-400G	UNIGREST2-1
Viscositeit bij 40°C	mm ² /s 200	200
Viscositeit bij 100°C	mm ² /s 16	16
Inhoud	kg 0,4	1,0
Verpakking	cartridge	blik
Prijs	€ 6,30	21,90



Vaste spuitpijp.

Order nr.	725473061	725473060
Orig. nr.	GRSSPUIT15	GRSSPUIT25
Lengte	mm 150	250
Maat	M 10x1	10x1
Prijs	€ 3,30	4,40



Flexibele slang voor handbediende en/of pneumatisch bediende smerpompen. Lengte 300mm. Max. werkdruk 400 bar.

Order nr.	724573330
Orig. nr.	GRSPP300
Aansluiting	M 10x1
Prijs	€ 9,90



Assortiment van 110 smeernippels van de meeste gangbare afmetingen.

Order nr.	161800406
Orig. nr.	IT011110
Aantal stuks	110
Smeernippels	M 30 st. 6x1 - recht, 20 st. 6x1 - 90° gebogen, 20 st. 8x1 - recht, 10 st. 8x1 - 90° gebogen, 20 st. 10x1 - recht, 10 st. 10x1 - 90° gebogen
Prijs	€ 35,90



Smeernippel 4 klauw. Voor types GRSP100, GRSP100 en GRSPN100.

Order nr.	724574180
Orig. nr.	GRSPK418
Type	EU
Aansluiting	M 10x1
Prijs	€ 4,40

TOOLS



Vulnippel voor vetpomp.

Order nr.	724551010	
Orig. nr.	GRBLV/01/M	
Aansluiting	M	10x1
Prijs	€	3,80

TOOLS



Open

Gesloten

Pomphouder. Voor de verschillende types smeerpompen.

Order nr.	724552020	
Orig. nr.	GRGGH01	
Prijs	€	7,80

TOOLS



Oliekannen met stalen reservoir en messing pomp. Geleverd met rechte en flexibele tuit.

Order nr.	724603000	724605000
Orig. nr.	OK300	OK500
Capaciteit	ml 300	500
Prijs	€ 8,50	10,00

TOOLS



Kunststof PE trechter. Schaalverdeling in lt. Met flexibele tuit.

OTR220 voorzien van adaptor, geschikt voor vaten.

Order nr.	724575220	
Orig. nr.	OTR220	
Capaciteit	ml	220
Prijs	€	11,50

TOOLS



Schenkan PE wit.

Order nr.	724575050	
Orig. nr.	OKS5	
Capaciteit	l	5
Prijs	€	14,90

Vloeistofpompen

TOOLS



Rotatieve chemicaliën pomp. Wordt gebruikt waar in normale gevallen een gietijzeren of metalen pomp niet kan worden gebruikt. De behuizing bestaat uit een glasvezel PP met Rytan versterkingen. Alle dichtingen zijn van Viton rubber en alle onderdelen zijn van roestvrij staal. Een zeef op het uiteinde van de aanzuigpijp verhindert vervuiling van de vloeistoffen. Geleverd met PP aanzuigpijp en 2" adaptor voor 50 en 200l vaten. Geschikt voor op water gebaseerde vloeistoffen, zuren, anti-vries, chemicaliën en alle met benzine relateerde vloeistoffen. Niet geschikt voor acetone, lakken, minerale oliën, solventen, terpentijn enz. Cap. 5 l per 20 omwentelingen.

Order nr.	724573035	
Orig. nr.	PPKW35	
Prijs	€	81,50

TOOLS



Rotatieve hevelpomp voor vaten tot 200 l. Aansluiting 2". Behuizing in gietijzer. Geschikt voor niet-corrosieve vloeistoffen en olie met hoge viscositeit. Cap. lift : 130 cm. Debiet 28 l/min.

Order nr.	754773030	
Orig. nr.	PPKW30	
Capaciteit	l/min	28
Prijs	€	28,90

TOOLS



De populaire universele hevelpomp. Kan gebruikt worden op vaten met 1 1/2" en 2" opening. Rubber handvat op de hendel voor een vlot gebruik. Met gebogen metalen tuit en een telescopische aanzuigpijp voor gebruik in 50 en 200 l vaten. Geschikt voor op olie gebaseerde vloeistoffen, motor oliën, diesel. De afdichtingsring is NBR. Niet geschikt voor gebruik met water, solventen, zuren, anti-vries, benzine enz. Cap. 300ml/stroke.

Order nr.	724573040	
Orig. nr.	PPKW40	
Prijs	€	29,90



Topkwaliteit membraampomp met dubbel diafragma. Industrieel model met zeer hoog debiet : 800 ml per pompbeweging. Ideaal voor gebruik waar geen gebruik kan worden gemaakt van luchtdruk of andere motorische of elektrische krachtbron. Roestvrijstalen zuiger en diesel resistent nitril-rubber membraam. Geleverd met 2" adaptor geschikt voor 50 en 200 l vaten. Met een hangslot afsluitbare hendel. Met aanzuigdarm met anti-terugslag klep. Afvoerdarm L. 240cm in anti-statisch neoprene rubber die handig kan worden opgehangen in een ingebouwde 'neushouder' op de pomp. Geschikt voor diesel, brandstofdiesel, motorolie en andere lichtere oliën en petroleumproducten. Niet geschikt voor corrosieve vloeistoffen, solventen, zuren, benzine, enz.

Opmerking. Brandstoffen met ethanol kunnen aanleiding geven tot meer frequent vervanging van de rubber onderdelen. Gebruik de pomp nooit in de omgeving van vuur of vonken omwille van een eventueel explosie gevaar. Deze pomp is geconcipiërd voor vloeistoffen met een lagere viscositeit. Het pompen met zwaardere vloeistoffen kan aanleiding geven tot overdadige slijtage.

Order nr. 724573055

Orig. nr. PPKW55

Prijs € 167,00



Hevelpomp. Eenvoudig te bedienen. Pompt vloeistoffen automatisch naar lagere reservoirs, en met handbediening ook naar hogere reservoirs. Geschikt voor vloeistoffen op waterbasis, detergents.

Order nr. 724570010 724570011

Orig. nr. PPKW10 PPKW11

Debiet l/m 6,5 17,5

Aansluiting inch 1 - 1/2 2

Voor type l 5 - 20 50 - 200

Lengte mm 533 1125

Lengte zuigslang mm 387 839

Interne diameter mm 14 18

Buitendiameter mm 16 22

Prijs € 6,70 14,50



NEW



Mini syphon hevelpomp.

Order nr. 724561031

Orig. nr. PPKW15

Lengte slang mm 2x1350

Diameter slang mm 27

Prijs € 15,90



Oliezuigpomp voor bvb transmissieoliën. Cap. 500 cc Geleverd met een flexibele vinyl leiding L. 300mm . Voor gebruik met niet-corrosieve vloeistoffen.

Order nr. 724571010

Orig. nr. GRSOZ100

Capaciteit ml 500

Prijs € 14,90



NEW



Remvloeistof tester.

Geschikt voor het meten van het vochtgehalte in remvloeistof. Met 3 LEDs die de conditie van de remvloeistof aangeven. Met DC-9V batterij

Order nr. 724561030

Orig. nr. OT200

Gewicht kg 0,30

Prijs € 39,90

TOOLS



6,5L
MANUEEL

• Incl. diam. 9,8 - 6,7 - 5,8mm



Handbediende vloeistofzuiger.

Geschikt voor:

- Het afzuigen van alle soorten motor en transmissieoliën, smeermiddelen van auto's, motoren, boten, stationaire motoren, vrachtwagens, mobilhomes, maaimachines, landbouwvoertuigen en industriële machines.
- Kan ook worden gebruikt voor het hevelen van niet-corrosieve vloeistoffen zoals water uit aquaria, enz.

Kenmerken:

- Efficiënte handbediening
- Bevat 3 flexibele slangen.
- Gemaakt van duurzame polyethyleen bestendig tegen huishoudelijke en automotieve chemicaliën.

Order nr.	724561009 €		
Orig. nr.		ODM06	
Capaciteit	l	6,5	
Diameter slang	mm	9,8-6,7-5,8	
Maximum temperatuur	°C	100	
Gewicht	kg	2,40	
Prijs	€	69,90	

TOOLS

6-18L
MANUEEL OF PNEUMATISCH

• Incl. diam. 9,8 - 6,7 - 5,8mm



Vloeistofzuiger met pneumatische of handmatige bediening

Geschikt voor:

- Het afzuigen van alle soorten motor en transmissieoliën, smeermiddelen van auto's, motoren, boten, stationaire motoren, vrachtwagens, mobilhomes, maaimachines, landbouwvoertuigen en industriële machines.
- Kan ook worden gebruikt voor het hevelen van niet-corrosieve vloeistoffen zoals water uit aquaria, enz.

Kenmerken:

- Capaciteit 6-10,5-18 liter.
- Efficiënte handbediening, maar ook pneumatisch d.m.v. perslucht.
- Bevat 3 flexibele slangen.
- Met overloopbescherming.
- Gemaakt van duurzame polyethyleen bestendig tegen huishoudelijke en automotieve chemicaliën.

Order nr.	724561010	724561011	724561012
	€	€	€
Orig. nr.	ODMP06	ODMP10	ODMP18
Capaciteit	l	6	10,5
Diameter slang	mm	9,8-6,7-5,8	9,8-6,7-5,8
Werkdruk	bar	6,2	6,2
Aansluiting	inch	1/4 NPT	1/4 NPT
Maximum temperatuur	°C	100	100
Gewicht	kg	2,90	3,30
Prijs	€	69,90	99,50
			142,00

TOOLS

3L
MANUEEL
ATF & REMMEN

• Incl. adaptoren & flexibel



Multifunctionele manuele remontluchter en transmissie vulpomp.

Capaciteit 3L, met geïntegreerde handpomp, manometer en een overdruk ventiel.

2 functies:

- Remontluchter met universele en Europese adapter voor de meeste automerken.
- Transmissie vulpomp voor onderhoud van gesloten automatische transmissies van de meeste automerken.

Bevat :

- Universele adapter remontluchter voor Mazda, Mitsubishi, Honda, Nissan, Toyota, Subaru en Ford
- Europese adapter remontluchter voor o.a. BMW, Audi, Saab, Mercedes, Mini cooper,...
- 8 transmissie adapters voor Mercedes, Ford, BMW, Honda, Nissan, VW, Porsche, Mini Cooper, Audi, ... (ook voor DSG/CVT versnellingsbak)
- Vulslang 150cm x 7,5mm
- Flexibel voor transmissie vulsysteem 60cm x 9,8 mm

Order nr.	724561014 €		
Orig. nr.		ODA03	
Capaciteit	l	3	
Gewicht	kg	1,30	
Prijs	€	79,90	

TOOLS

2L
PNEUMATISCH
MET REMMEN



• Incl. vulflacon 1l



Pneumatische remontluchter.

Kenmerken:

- Ontluchter voor remvloeistof en stuurbevestigingsvloeistof.
- Voor gemakkelijk ontluchten door slechts één persoon.
- Aansluiting op perslucht (compressor) met koppeling 1/4"

Voorzien van 2 liter vloeistof opvangtank, flexibel 5,8mm x 150 cm en 1 liter vulflacon

Order nr.	724561013 €		
Orig. nr.		ODR02	
Capaciteit	l	2	
Diameter slang	mm	5,8	
Werkdruk	bar	6,2	
Aansluiting	inch	1/4 NPT	
Maximum temperatuur	°C	100	
Gewicht	kg	1,80	
Prijs	€	59,50	

EQUIPMENT

Rolkriks

TOOLS



2T
PVC KOFFER
COMPACT

Hydraulische rolkrik op wielen met **capaciteit 2 ton**.

Kenmerken:

- Metalen wielen.
- Handige pvc draagbeugel op de krik.

Geleverd in een handige pvc-koffer.

Order nr.	754752220 €	
Orig. nr.	CATM200	
Capaciteit	t	2
Hoogte minimum	mm	130
Hoogte maximum	mm	380
Hefhoogte	mm	250
Gewicht	kg	12,00
Prijs	€	56,50

TOOLS



NEW
1,5T
STEEL ALU
LIGHT

Hydraulische rolkrik op wielen met **capaciteit 1,5 ton**.

Kenmerken:

- **Zeer licht, dus super handig**
- Licht en gemakkelijk draagbaar door **aluminium** chassis en wielen
- Solide basis uit plaatstaal geschikt voor dagelijks gebruik
- Met alu handvatten op het chassis
- Professioneel toestel
- Extra laag, geschikt voor sportwagens
- Extra plat en uiterst robuust, dankzij de **dubbele pistons**
- Dubbele cilinder
- Vast voorwiel voor betere stabiliteit
- Draaiend zadel

Order nr.	754752266 €	
Orig. nr.	CAT15ALU	
Capaciteit	t	1,5
Minimale hefhoogte	mm	90
Maximale hefhoogte	mm	360
Gewicht	kg	14,30
Afmetingen (l x b x h)	mm	590 x 290 x 175
Prijs	€	128,00

TOOLS



2T
PVC KOFFER
COMPACT
LAAG PROFIEL

Hydraulische rolkrik op wielen **voor lage voertuigen** met **capaciteit 2 ton**.

Kenmerken:

- Met gietijzeren wielen
- Draagbeugel op de krik.
- Semi-professioneel gebruik.

Geschikt voor:

- Sportieve wagens
- Verlaagde wagens

Geleverd in een handige PVC koffer.

Order nr.	754752221 €	
Orig. nr.	CAT2L	
Capaciteit	t	2
Hoogte minimum	mm	85
Hoogte maximum	mm	330
Hefhoogte	mm	245
Gewicht	kg	11,00
Prijs	€	52,50

TOOLS



2,5T
STEEL ALU
PRO

Hydraulische rolkrik op wielen met **capaciteit 2,5 ton**.

Kenmerken

- Licht en gemakkelijk draagbaar door **aluminium** chassis en wielen.
- Solide basis uit plaatstaal geschikt voor dagelijks gebruik.
- Met alu handvatten op het chassis.
- Professioneel toestel.

Order nr.	754752262 €	
Orig. nr.	CAT25ALU	
Capaciteit	t	2,5
Hoogte minimum	mm	100
Hoogte maximum	mm	460
Hefhoogte	mm	360
Gewicht	kg	26,00
Afmetingen (l x b x h)	mm	650 x 292 x 170
Prijs	€	165,00

TOOLS



2,5T

LAAG PROFIEL

Hydraulische garagekrik op wielen met **capaciteit 2,5 ton**.

Kenmerken:

- Extra laag profiel.
- Voor professioneel gebruik.
- Gietijzeren wielen.
- Plaatstalen chassis.

Geschikt voor:

- Sportieve wagens
- Verlaagde wagens

Order nr.	754752260 €	
Orig. nr.	CAT25TL	
Capaciteit	t	2,5
Hoogte minimum	mm	85
Hoogte maximum	mm	455
Hefhoogte	mm	368
Gewicht	kg	36,00
Prijs	€	129,00

TOOLS



3T

QUICKLIFT

Hydraulische rolkrik op wielen met **capaciteit 3 ton**.

Kenmerken:

- Met quicklift voetpedaal.
- Stevige gietijzeren wielen.
- Rubber dop.
- Professioneel gebruik.

Order nr.	754753000 €	
Orig. nr.	CATM300T	
Capaciteit	t	3
Hoogte minimum	mm	145
Hoogte maximum	mm	520
Hefhoogte	mm	375
Quicklift pedaal		✓
Gewicht	kg	39,00
Prijs	€	129,00

TOOLS



2T

SPEED PUMP

LAAG PROFIEL

LANGE UITBOUW

Quick lift pomp

Hydraulische garagekrik op wielen met **extra lage en lange uitbouw** en **capaciteit 2 ton**.

Kenmerken:

- Zwaar frame met extra steunwiel middenin voor eenvoudig verplaatsen.
- Grote en geruisloze gecoate PU wielen.
- Rubber dop.
- Met quick lift voetpedaal.

Geschikt voor:

- Sportieve wagens
- Verlaagde wagens

Order nr.	754752261 €	
Orig. nr.	CAT2TLL	
Capaciteit	t	2
Hoogte minimum	mm	75
Hoogte maximum	mm	510
Hefhoogte	mm	435
Quicklift pedaal		✓
Gewicht	kg	42,00
Prijs	€	264,00

TOOLS



3T

SPEED PUMP

LAAG PROFIEL

LANGE UITBOUW

Hydraulische garagekrik met **extra lage en lange uitbouw** en **capaciteit 3 ton**.

Kenmerken:

- Zwaar frame met extra steunwiel middenin voor eenvoudig verplaatsen.
- Grote en geruisloze gecoate PU wielen.
- Rubber dop.
- Met quick lift voetpedaal.

Geschikt voor:

- Sportieve wagens
- Verlaagde wagens

Order nr.	754752270 €	
Orig. nr.	CAT3TLL	
Capaciteit	t	3
Hoogte minimum	mm	140
Hoogte maximum	mm	525
Hefhoogte	mm	385
Quicklift pedaal		✓
Gewicht	kg	55,00
Afmetingen (l x b x h)	mm	1150 x 350 x 180
Prijs	€	315,00

EQUIPMENT



TOOLS



10T

Zware hydraulische rolkrik met **capaciteit 10 ton**.

Geschikt voor vrachtwagens, bussen, ...

Kenmerken:

- Met quick-lift pedaal.
- Grote gietijzeren wielen.
- Heel sterk.

Order nr.	754751000 E	
Orig. nr.	CATM1000N	
Capaciteit	t	10
Hoogte minimum	mm	160
Hoogte maximum	mm	560
Hefhoogte	mm	400
Quicklift pedaal		✓
Gewicht	kg	145,00
Afmetingen (l x b x h)	mm	1640 x 480 x 260
Prijs	€	699,00

EQUIPMENT

TOOLS



22T

HYDROPNEUMATISCH

Hydraulisch-pneumatische rolkrik met **capaciteit 22 ton**.

Kenmerken:

- Door aansluiten op compressor wordt de hoge hefcapaciteit bereikt.
- Grote rubbergecoate wielen.
- CE conform.

Geleverd met 3 verlengstukken voor een hefhoogte tot 448mm.

Order nr.	754750022 E	
Orig. nr.	CAT822	
Capaciteit	t	22
Hoogte minimum	mm	228
Hoogte maximum	mm	448
Hefhoogte	mm	220
Drukluicht		✓
Gewicht	kg	40,00
Afmetingen (l x b x h)	mm	660 x 360 x 280
Prijs	€	439,00

TOOLS



40T

HYDROPNEUMATISCH

Hydropneumatische rolkriks met **capaciteit 40 ton**, voor het heffen van vrachtwagens, tractoren, bussen, ...

Hardverchroomde cilinder met lange levensduur wordt geleverd met 2 extensiestukken (75mm en 45mm) voor hogere hefhoogtes. Hoogkwalitatieve rubber dichtingen en olie 'made in USA' (Dow Corning) zijn perfect op elkaar afgestemd, voor een langdurig blijvende smering van de krik.

Kenmerken:

- Hendel voor automatische bediening is vergrendelbaar in 3 standen.
- Bedieningsknop in roestvast staal, met trage slijtage als gevolg.
- Werktemperatuur: -25°C tot +50°C.
- Met overbelastingsventiel.
- CE conform.

Ook geschikt voor voertuigen met lage wielas.

Order nr.	754752286 E	
Orig. nr.	HPK2040L	
Capaciteit	t	40
Hoogte minimum	mm	150
Hoogte maximum	mm	409
Capaciteit niveau 1	t	40
Capaciteit niveau 2	t	20
Gewicht	kg	40,00
Prijs	€	929,00

Pneumatische kriks

TOOLS



NEW

Pneumatische krik 2 ton.

Kenmerken:

- Capaciteit 2 ton
- 2 trappen
- Interne telescopische geleiding
- Overdrukventiel
- Blokkeerinrichting op de maximale hoogte

Order nr.	910000216 €	
Orig. nr.		AGC22
Capaciteit	t	2
Werkdruk	bar	7
Aantal trappen		2
Hoogte minimum	mm	165
Hoogte maximum	mm	345
Gewicht	kg	14,00
Afmetingen (l x b x h)	mm	400 x 300 x 215
Prijs	€	356,00

TOOLS



NEW

Pneumatische krik 3 ton met wielen.

Kenmerken:

- Capaciteit 3 ton
- 3 trappen
- Interne telescopische geleiding
- Overdrukventiel
- Blokkeerinrichting op de maximale hoogte
- Met 2 wielen

Order nr.	910000218 €	
Orig. nr.		AGC33
Capaciteit	t	3
Werkdruk	bar	7
Aantal trappen		3
Hoogte minimum	mm	145
Hoogte maximum	mm	420
Gewicht	kg	27,00
Afmetingen (l x b x h)	mm	540 x 335 x 380
Prijs	€	739,00

TOOLS



NEW

Pneumatische krik 2 ton.

Kenmerken:

- Capaciteit 2 ton
- 3 trappen
- Interne telescopische geleiding
- Overdrukventiel
- Blokkeerinrichting op de maximale hoogte

Order nr.	910000217 €	
Orig. nr.		AGC23
Capaciteit	t	2
Werkdruk	bar	7
Aantal trappen		3
Hoogte minimum	mm	190
Hoogte maximum	mm	480
Gewicht	kg	16,00
Afmetingen (l x b x h)	mm	400 x 300 x 215
Prijs	€	460,00

Transmissiekriks

TOOLS



0,5T

Transmissiekrik op wielen.

Kenmerken:

- Capaciteit 500 kg.
- Met pedaal.
- Met dodemansknop

Order nr.	754750500 €	
Orig. nr.		CAT755
Capaciteit	kg	500
Hoogte minimum	mm	1100
Hoogte maximum	mm	1900
Gewicht	kg	32,00
Afmetingen (l x b x h)	mm	570 x 570 x 1100
Prijs	€	230,00

EQUIPMENT

Fleskriks

TOOLS



Hydraulische fleskrik.

Kenmerken:

- Met schroefvijzel en overbelastingsventiel.
- Modellen tot en met 5 T worden geleverd in kunststof opbergdoos.
- Model 30 T zonder schroefvijzel.

Order nr.	Orig. nr.	Capaciteit t	Hoogte minimum mm	Hoogte maximum mm	Koers mm	Uitdraai-baar (vijzel) mm	Prijs €
754751103	€ CATM11030	3	194	372	118	60	19,00
754751105	€ CATM11050	5	216	413	127	70	28,90
754751108	€ CATM11080	8	230	457	147	80	31,90
754751112	€ CATM11120	12	230	445	155	60	36,90
754751120	€ CATM11200	20	242	452	150	60	43,90
754751300	€ CATM11300	30	285	465	145	-	109,00

Kolomvijzels

TOOLS



Multifunctionele kolomvijzel. Licht en direct inzetbaar in alle omstandigheden

Functies:

- Verticaal gebruik: voor het snel optillen van bv. auto's, grasmaaiers, tractoren, werktuigen, ...
- Horizontaal gebruik: voor het duwen of trekken van lasten

Kenmerken:

- Groot werkbereik: 130-1325 mm
- Cap. heffen: 400 kg
- Cap. ondersteunen: tot 2000 kg
- Met stabiele voet, veiligheidspal en vaste opklapbare hendel.
- CE conform.

Order nr.	758601032 €	
Orig. nr.	HNFJ2T	
Hefcapaciteit	kg	400
Hefhoogte	mm	130-1325
Maximum belastbare capaciteit	kg	2000
Gewicht	kg	17,00
Afmetingen (l x b x h)	mm	240 x 140 x 1540
Prijs	€	99,00

Uitdeuksets

TOOLS



Hydraulische uitdeukset 10T. Compleet met handpomp, hydraulische slang, pvc-cilinder, spreider (0,5T), opzet- en verlengstukken. Met pvc-koffer uitgerust met wielen voor een gemakkelijk transport.

Order nr.	754751110 €	
Orig. nr.	CATM10CLIP	
Capaciteit	t	10
Gewicht	kg	32,00
Prijs	€	184,00

TOOLS



Stukken CATM10CLIP.

Order nr.	Orig. nr.	Omschrijving	Prijs €
998140013	€ CATM10PNR40	pomp 10T (zonder slang)	77,90
754751131	€ CATM10RAM	duwcilinder 10T	54,90
998140032	€ CATRAM4TS	duwcilinder 4T	53,50
998140007	€ CAT80411	schaar - spreider 4T/10T	35,90
998140005	€ CATM4/10-NEW	snelkoppeling 1/2" M. universeel	6,20
998140030	€ CATM4/10	snelkoppeling 1/2"-1" M+F (2 dlg)	8,10

Motorhangers

TOOLS



Evenaar / motorhanger voor het uitbalanceren van lasten op takels en kranen.
Capaciteit 680 kg.

Met de spindel wordt de last in balans gebracht.

Voor het gebalanceerd en veilig optakelen van motoren, balken, lasten.

Hijsgoog past op de haak van de meeste takels en garagekranen.

Order nr.	754751500 €		
Orig. nr.	CAT1500		
Capaciteit	kg	680	
Gewicht	kg	5,50	
Afmetingen (l x b x h)	mm	445 x 64 x 190	
Prijs	€	27,00	

Zunicraft



NEW

Motorhefbrug lange versie voor het uitbalanceren van motoren en lasten op takels en kranen.

Gebalanceerd en veilig optakelen van onevenwichtig verdeelde lasten.

Geleverd met:

- Verstelbare veiligheidskettingen
- Draaibare en vaststelbare steunvoetjes

Order nr.	716201705 €		
Orig. nr.	MMB505		
Capaciteit	kg	500	
Instelbereik	mm	0-250	
Aslengte	mm	730-1480	
Gewicht	kg	17,50	
Afmetingen (l x b x h)	mm	1540 x 150 x 110	
Prijs	€	79,50	

Zunicraft



NEW

Kraanweegschaal

Order nr.	716170405 €	716170410 €
Orig. nr.	KW5	KW10
Capaciteit	t	10
Gradatie <2T	kg	1
Gradatie 2t-5t	kg	2
Gradatie 5t-10t	kg	10
Afstand haak - ophanging	mm	585
Diameter ophanging	mm	92
Opening haak	mm	45
Overbelasting max.	%	400
Gewicht	kg	24,00
Prijs	€	789,00
		1.085,00

EQUIPMENT

Werkplaatskranen



dodemansventiel

Garagekraan capaciteit 1ton.

Kenmerken:

- Oplooibaar model voor eenvoudig opbergen.
- Draaibare achterwielen en stevige metalen topwielen.
- Manueel bediende hydraulische cilinder met overbelastingsventiel.
- Arm met 4 lengte posities.
- Daalventiel met dodemansknop.

Order nr.	754756100 €		
Orig. nr.	CAT610		
Capaciteit	t	1	
Hefbereik	mm	25-1800	
Gewicht	kg	72,00	
Afmetingen (l x b x h)	mm	1470 x 1190 x 2150	
Prijs	€	298,00	



Garagekraan 1 ton in zware uitvoering

Kenmerken:

- Hoge hefhoogte toe tot 2320 mm.
- Robuust stalen chassis, enorm stabiel
- Hefarm met verschillende lengteposities.
- Oplooibaar voor gemakkelijk stockeren.
- Draaibare achterwielen en zware volmetalen topwielen.
- Hydraulische cilinder met overbelastingsventiel.

Order nr.	754756120 €		
Orig. nr.	CAT6100T		
Capaciteit	t	1	
Hefbereik	mm	250- 2320	
Gewicht	kg	122,00	
Afmetingen (l x b x h)	mm	1640 x 510 x 2320	
Prijs	€	599,00	

TOOLS



2T

Garagekraan 2 ton. Plooibaar model. Met draaibare achterwielen. Stevige metalen topwielen. Hydraulische cilinder met overbelastingsventiel. Arm met 4 posities. Daalventiel met dodemansknop.

Order nr.	754756200 €	
Orig. nr.	CAT620	
Capaciteit	t	2
Hefbereik	mm	25-2300
Gewicht	kg	87,50
Afmetingen (l x b x h)	mm	1750 x 1020 x 2300
Prijs	€	359,00

TOOLS



Hydraulische fleskrik, lang model.

- Met overbelastingsventiel.
- Geschikt voor garagekranen CAT610/ CAT620.

Order nr.	754756161 €	754756162 €	754756262 €	
Orig. nr.	CATRAM610C	CATRAM610C-N	CATRAM620	
Capaciteit	t	3	5	8
Hoogte minimum	mm	670	670	670
Hoogte maximum	mm	1165	1165	1165
Koers	mm	495	495	495
Kenmerken	met dodemansknop			
Gewicht	kg	13,50	14,00	17,00
Prijs	€	64,90	59,90	70,90

TOOLS



0,9T



Hydraulische aanhangerkraan

Uiterst geschikt voor:

- Pick-up
- Bestelbus
- Aanhangwagen

2 standen:

- bereik arm 76cm: last tot 900 kg
 - bereik arm 113 cm: last tot 450 kg
- (bereik arm horizontaal gemeten vanaf het midden van de voet)

Kenmerken:

- Plooibaar, neemt weinig ruimte in
- Hydraulisch in de hoogte verstelbaar, 870-1290mm
- 360° draaibare grondplaat

Bestaat uit:

- Lier met handbediening
- Staalkabel

Order nr.	754753100 €	
Orig. nr.	CAT900	
Hoogte minimum	mm	870
Hoogte maximum	mm	1290
Hefbereik	mm	0-1130
Capaciteit	kg	900
Gewicht	kg	55,00
Prijs	€	252,00

EQUIPMENT

	DEG160	RFU	Eco P.N.
verkrijgbaar in	5, 25, 60, 210L	25, 60L	5, 25 L
type	solvent	waterbasis	waterbasis
toepassing	onverdund	onverdund	verdund
RPW510	geschikt	geschikt	geschikt
RPW270V	geschikt	geschikt	geschikt
RPW595A	niet geschikt	zeer geschikt	geschikt

REINIGINGSPRODUCTEN

p. 439



Onderdelenreinigers



INDUSTRIËLE KWALITEIT

SOLVENT OF WATER



CE Ex II 3GD

Manuele onderdelenreiniger

Kenmerken:

- Geschikt voor reinigen met solvent of op waterbasis
- Eenvoudige en gebruiksvriendelijke bediening
- Met automatische dampafzuiging
- Geschikt voor vaten van 60 l
- Inclusief ATEX/VEXAT certificaat voor ATEX Zone II 3GD

Geleverd met:

- Borstel
- Persluchtpistool voor drogen

Order nr.	754720006 €	
Orig. nr.	RPW510	
Werking	pneumatisch	
Vaten	1x60 l	
Reinigings temperatuur	°C	koud
Gewicht	kg	35,00
Afmetingen (l x b x h)	mm	620 x 620 x 1280
Prijs	€	1.095,00



INDUSTRIËLE KWALITEIT

WARM WATER

CE

Manuele onderdelenreiniger warm water.

Kenmerken:

- Geschikt voor reinigen op waterbasis
- Eenvoudige en gebruiksvriendelijke bediening
- Met geïsoleerde tank warm water
- Capaciteit tank 60 l
- Tijd nodig om 60 l te verwarmen op 45°C : 1 uur
- Schakelt automatisch uit na 12 uren
- Volledig uit roestvrij staal

Geleverd met:

- Borstel
- Persluchtpistool voor drogen

Order nr.	754720007 €	
Orig. nr.	RPW595A	
Spanning	V	230
Werking	pneumatisch+elektrisch	
Totale inhoud tank	l	60
Vermogen motor pomp	W	1000
Reinigings temperatuur	°C	45
Pomp	membraanpomp	
Gewicht	kg	35,00
Afmetingen (l x b x h)	mm	935 x 690 x 1300
Prijs	€	2.255,00

MACH



**INDUSTRIËLE
KWALITEIT
VOOR REMMEN**

CE Ex II 3GD



Manuele onderdelenreiniger mobiel.

Kenmerken:

- Ideaal voor reinigen remmen
- Geschikt voor reinigen met solvent of op waterbasis
- Eenvoudige en gebruiksvriendelijke bediening
- Wastafel met wielen, geschikt om zowel op hoogte 1 m als op de grond te plaatsen
- Met gebrevetteerd systeem om vloeistof terug in het vat te pompen
- Inclusief ATEX/VEXAT Certificaat voor ATEX Zone II 3GD

Geleverd met:

- Borstel
- Persluchtpistool voor drogen

Order nr.	754720008 €	
Orig. nr.	RPW270V	
Afmetingen werkblad (l x b x h)	mm	900x585x100
Werkling	pneumatisch	
Totale inhoud tank	l	53
Wielen	✓	
Reinigings temperatuur	°C	koud
Gewicht	kg	41,00
Afmetingen (l x b x h)	mm	600 x 950 x 1040
Prijs	€	1.475,00

MACH



Professionele staande onderdelenreiniger Type M.

Kenmerken:

- Stevige en robuuste plaatstalen constructie.
- Groot werkblad voor het reinigen van grote en zware onderdelen.

Geleverd met:

- een onderhoudsvrije IBS gebreveteerde circulatiepomp
- voetpedaal-bediening
- reinigingsborstel.

Zonder reinigingsmiddel of opvangbak. "Purgasol" ontvetter apart beschikbaar.

Order nr.	754753115 €	
Orig. nr.	IBSTYPM	
Geschikt voor vaten van	l	200
Afmetingen werkblad (l x b x h)	mm	1145x660x900
Belastbaarheid werkblad	kg	150
Spanning	V	230
Frequentie	Hz	50
Gewicht	kg	47,00
Prijs	€	899,00

MACH



Professionele mobiele onderdelenreiniger Type F2.

Kenmerken:

- Stevige en compacte plaatstalen constructie.

Geleverd met :

- een onderhoudsvrije IBS gebreveteerde circulatiepomp
- voetpedaal-bediening
- reinigingsborstel.

Zonder reinigingsmiddel. "Purgasol" ontvetter apart beschikbaar.

Order nr.	754753080 €	
Orig. nr.	IBSTYFP2	
Geschikt voor vaten van	l	50
Afmetingen werkblad (l x b x h)	mm	800x540x900
Belastbaarheid werkblad	kg	60
Spanning	V	230
Frequentie	Hz	50
Gewicht	kg	43,00
Prijs	€	1.035,00



Onderdelenreiniger 14L wandmodel, inklapbaar.

Kenmerken:

- Met reservoir, ingebouwde pomp, metalen flexibel en borstel.
- Met ingebouwde lamp. 240V, 26W.
- Kan zowel aan de muur bevestigd worden als staand gebruikt worden.
- Inklapbaar, neemt weinig plaats in, ideaal om boven de werkbank te bevestigen.
- Geschikt voor reiniging van kleine mechanische onderdelen, motoronderdelen, etc.

Order nr.	754751314 €	
Orig. nr.	CAT140	
Spanning	V	240
Vermogen motor pomp	W	26
Capaciteit	l	14
Afmetingen opengeklapt (l x b x h)	mm	545x560x630
Gewicht	kg	24,00
Afmetingen (l x b x h)	mm	560 x 280 x 660
Prijs	€	159,00



Onderdelenreiniger.

Kenmerken:

- Tafelmodel met een inhoud van 19lt.
- Met reservoir
- ingebouwde pomp
- metalen flexibel.
- De ontvetter circuleert in de reiniger tot deze wordt afgelaten via de aflaatstop.
- Met smeltveiligheid tegen ontbranding in de reiniger.

Order nr.	754751350 €	
Orig. nr.	CAT135	
Spanning	V	220
Totale inhoud tank	l	19
Minimum inhoud solvent	l	7,5
Maximum inhoud solvent	l	10
Doorstroomsnelheid	l/min	2,7 - 3,3
Gewicht	kg	6,50
Afmetingen (l x b x h)	mm	340 x 430 x 220
Prijs	€	56,50



Onderdelenreiniger. Voetmodel met een inhoud van 75lt.

De ontvetter circuleert in de reiniger tot deze wordt afgelaten via de aflaatstop.

Met smeltveiligheid tegen ontbranding in de reiniger.

Geleverd met:

- reservoir
- ingebouwde vloeistofpomp
- metalen flexibel.

Order nr.	754752222 €	
Orig. nr.	CAT220	
Spanning	V	230
Totale inhoud tank	l	75
Minimum inhoud solvent	l	40
Maximum inhoud solvent	l	50
Doorstroomsnelheid	l/min	2,7 - 3,3
Gewicht	kg	23,00
Afmetingen (l x b x h)	mm	540 x 760 x 880
Prijs	€	159,00



Onderdelenreiniger. Voetmodel met een inhoud van 150lt.

Met:

- reservoir
- ingebouwde vloeistofpomp en metalen flexibel.
- De ontvetter circuleert in de reiniger tot deze wordt afgelaten via de aflaatstop.
- Met smeltveiligheid tegen ontbranding in de reiniger.

Order nr.	754751340 €	
Orig. nr.	CAT340	
Afmetingen werkblad (l x b x h)	mm	560x545x360
Spanning	V	220
Totale inhoud tank	l	150
Minimum inhoud solvent	l	70
Maximum inhoud solvent	l	83
Doorstroomsnelheid	l/min	2,7 - 3,3
Gewicht	kg	42,00
Afmetingen (l x b x h)	mm	540 x 1130 x 890
Prijs	€	229,00

	DEG160	RFU	Eco P.N.
verkrijgbaar in	5, 25, 60, 210L	25, 60L	5, 25 L
type	solvent	waterbasis	waterbasis
toepassing	onverdund	onverdund	verdund
CAT135, CAT140, CAT220, CAT340	geschikt	geschikt	geschikt

MACH



Geconcentreerd vloeibaar reinigingsproduct met een bijzonder hoog percentage aan actieve ingrediënten, waardoor het zeer geschikt is voor het reinigen en ontvetten van vette en met olie vervuilde oppervlakken of andere (atmosferische) verontreinigingen. Verwijdert eveneens inkresten, pigmenten, voedingsresten,...

Kenmerken:

- Geconcentreerd product, dus economisch in gebruik
- Alkalisch (pH 12,5)
- Biologisch afbreekbaar
- Densiteit 1,045
- Volledig oplosbaar in water
- Bruikbaar in voedingsindustrie

Toepassing: Verdunnen met water tot max. 1:100, afhankelijk van de aard en mate van vervuiling.

Order nr.	754725008 ^E	754725009 ^E	754725011 ^E
Orig. nr.	ECOPLUS5	ECOPLUS25	ECOPLUS60
Omschrijving	reinigingsproduct	reinigingsproduct	reinigingsproduct
Inhoud	l 5	25	60
Gewicht	kg 5,00	25,00	63,00
Prijs	€ 18,50	71,90	159,00

MACH



RFU

Gebruiksklare reiniger op waterbasis die geschikt is ter vervanging van koudreinigers op basis van solventen. Het kan gebruikt worden in diverse industrietakken voor zowel handmatige reiniging, evenals reiniging met behulp van spoeltafel of verneveling.

Eigenschappen:

- Toepasbaar op koolstofstaal, aluminium, gelakte ondergronden en andere non-ferrometalen, kunststoffen
- Gebruiksklaar
- Niet brandbaar of giftig, dus geen afzuiging vereist
- Biologische afbreekbaar
- Licht alkalisch (pH 10,05)
- Densiteit 1,01
- Volledig oplosbaar in water

Toepassing: onverdund

Order nr.	754725006 ^E	754725007 ^E
Orig. nr.	RFU25	RFU60
Omschrijving	reinigingsmiddel op waterbasis	reinigingsmiddel op waterbasis
Inhoud	l 25	60
Gewicht	kg 25,00	63,00
Prijs	€ 129,00	259,00

MACH



DEG

Industriële reiniger/ontvetter op basis van solventen. Verwijdert probleemloos ingedroogde oliën en vetten en vele andere industriële vervuilingen op machines en vloeren.

Eigenschappen:

- Verdampft snel (relatieve verdampingsnelheid = 0,01 sec.)
- Niet emulgerend
- Redelijk neutrale geur
- Vlampunt 66 °C

Toepassing: onverdund

Order nr.	754725001 ^E	754725002 ^E	754725003 ^E	754725004 ^E
Orig. nr.	DEG160	DEG16025	DEG16060	DEG160210
Omschrijving	reiniger/ontvetter	reiniger/ontvetter	reiniger/ontvetter	reiniger/ontvetter
Inhoud	l 5	25	60	210
Gewicht	kg 5,00	25,00	63,00	220,00
Prijs	€ 22,90	88,90	219,00	595,00

TOOLS



Universele borstel met PVC-aansluitingslang voor onderdelenreinigers. Geschikt voor CAT220-340.

Order nr.	754752225 ^E
Orig. nr.	CAT220BR
Gewicht	kg 0,13
Prijs	€ 9,10

TOOLS



Reiningsborstel voor onderdelenreinigers type M en F2. Zachte of harde borstel beschikbaar.

Order nr.	754753990 ^E	754753995 ^E
Orig. nr.	IBSBH	IBSBZ
Omschrijving	l hard	zacht
Prijs	€ 17,50	17,50

TOOLS

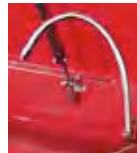

Koelleiding metaal 1/4" 600mm

Order nr.	754751561 ^E
Orig. nr.	CAT220-FL24
Diameter	1/4"
Lengte	mm 600
Materie	metaal
Omschrijving	flexibel
Gewicht	kg 0,20
Prijs	€ 13,50

Verfpistolenreinigers

MACH

SOLVENT

WATER



CE Ex II 2GD

Pneumatische verfspuitpistolen reiniger voor solvent- en watergedragen lakken - combi

Werking

Watergedragen lakken:

- Voorreiniging met herbruikbaar water en borstel, aangedreven door zeer kwalitatieve membraanpomp
- Nareiniging door verstuiver met zuiver water (aansluiting op waterleiding)
- Droogblazen door middel van persluchtpistool
- Om vervuild water in de voorreinigingstank te recyclen: Door coaguleringsmiddel RFL02 toe te voegen, kan met een pneumatische roerder het verontreinigde water gescheiden worden van het vuil. Door de filterkit komt het water weer beschikbaar voor voorreiniging

Solventgedragen lakken:

- Voorreiniging met herbruikbare verdunner, aangedreven door eerste venturipomp
- Nareiniging met zuivere verdunner, aangedreven door tweede venturipomp

Kenmerken:

- Eenvoudige en gebruiksvriendelijke bediening
- Met automatische dampafzuiging
- Capaciteit tank 50 l (Waterbasis)
- Ruimte onderaan voor 2 vaten van 30 l (solvent basis)
- Mogelijkheid om een tweede borstel aan te sluiten op de waterleiding
- Volledig uit roestvrij staal
- Aansluiting op perslucht en waterleiding
- Mogelijkheid om kleurstalen te spuiten (color tests allowed)
- Inclusief ATEX/VEXAT certificaat voor ATEX Zone II 2G

Geleverd met:

- Borstel (voorreiniging water)
- Vernevelaar (nareiniging water)
- Persluchtpistool
- 4 l detergent RRE04
- Filterkit

Order nr.	754720005 €	
Orig. nr.	RVP165	
Werking	pneumatisch	
Type	conventionele + watergedragen lakken	
Vaten	2x30 l	
Gewicht	kg	58,00
Afmetingen (l x b x h)	mm	790 x 690 x 1385
Prijs	€	2.425,00

MACH

WATER



CE Ex II 2GD



Pneumatische verfspuitpistolen reiniger voor watergedragen lakken.

Werking

- Voorreiniging met herbruikbaar water, aangedreven door zeer kwalitatieve membraanpomp.
- Nareiniging door verstuiver met zuiver water (aansluiting op waterleiding).
- Droogblazen door middel van persluchtpistool.
- Om vervuild water in de voorreinigingstank te recyclen: Door coaguleringsmiddel RFL02 toe voegen, kan met een pneumatische roerder het verontreinigde water gescheiden worden van het vuil. Door de filterkit komt het water weer beschikbaar voor voorreiniging

Kenmerken:

- Eenvoudige en gebruiksvriendelijke bediening
- Volledig uit roestvrij staal
- Capaciteit tank : 50 l
- Mogelijkheid om een tweede borstel aan te sluiten op de waterleiding.
- Aansluiting op perslucht en waterleiding
- Inclusief ATEX/VEXAT Certificaat voor ATEX Zone II 2 GT5

Geleverd met:

- Borstel (voorreiniging)
- Vernevelaar (nareiniging)
- Drukluftpistool
- Zijtafel (links en rechts monteerbaar)
- 4L detergent RRE04
- Filterkit

Order nr.	754720001 €	
Orig. nr.	RVP177X	
Werking	pneumatisch	
Type	Watergedragen lakken	
Totale inhoud tank	l	50
Reinigingstemperatuur	°C	koud
Pomp	1 membraanpomp	
Gewicht	kg	44,00
Afmetingen (l x b x h)	mm	450 x 660 x 1335
Prijs	€	1.575,00



CE Ex II 2GD
Pneumatische
verfspuitpistolenreiniger
voor watergedragen
lakken met warm water.

Werking

- Voorreiniging met herbruikbaar water, aangedreven door zeer kwalitatieve membraanpomp.
- Nareiniging met zuiver water (aansluiting op waterleiding)
- Droogblazen door middel van perslucht pistool.
- Om vervuild water in de voorreinigingstank te recyclen : Door coaguleringsmiddel RFL02 toe te voegen, kan met een pneumatische roerder het verontreinigde water gescheiden worden van het vuil.
- Door de filterkit komt het water weer beschikbaar voor voorreiniging.

Kenmerken:

- Eenvoudige en gebruiksvriendelijke bediening.
- Sterk gereduceerde reinigingstijd door warm water (45°C)
- Electronische display voor temperatuursregeling en -controle
- Met automatische dampafzuiging.
- Capaciteit tank 50 l
- Mogelijkheid om een tweede borstel aan te sluiten op de waterleiding
- Mogelijkheid om kleurstalen te spuiten
- Electriche weerstand onder de kuip
- Volledig uit roestvrij staal
- Aansluiting op perslucht, elektrisch net en waterleiding

Inclusief:

- Borstel (voorreiniging)
- Vernevelaar (nareiniging)
- Perslucht pistool
- Zijtafel (links en rechts monteerbaar)
- 4 l detergent RRE04
- Filterkit

Order nr.		754720002
Orig. nr.		RVP920X
Spanning	V	230
Werking		pneumatisch+elektrisch
Type		Watergedragen lakken
Totale inhoud tank	l	50
Vermogen motor pomp	W	1000
Reinigings temperatuur	°C	0-45
Pomp		1 membraanpomp
Gewicht	kg	43,00
Afmetingen (l x b x h)	mm	450 x 670 x 1410
Prijs	€	2.585,00

In de professionele MW Mach onderdelenreinigers en verfspuitpistolen-reinigings wordt gebruik gemaakt van gepatenteerde membraanpompen. Deze, zo goed als onbreekbare pompen, zorgen voor een uiterst betrouwbare werking van de toestellen.



- Pomp met verbeterde vloeistofdoorlaat
- Ontworpen en geproduceerd in Italië
- Betrouwbaar en eenvoudig te onderhouden
- Al meer dan 20 jaar bewezen kwaliteit
- Geleverd met CE en ATEX attest



Pneumatische verfspuitpistoolreiniger voor solvent gedragen lakken

Kenmerken:

- Voorreiniging met herbruikbare verdunner, aangedreven door eerste membraanpomp
- Nareiniging met zuivere verdunner, aangedreven door tweede membraanpomp
- Eenvoudige en gebruiksvriendelijke bediening
- Met automatische dampafzuiging
- Ruimte onderaan voor 2 vaten van 30 l
- Mogelijkheid om kleurstalen te spuiten (color tests allowed)
- Inclusief ATEX/VEXAT certificaat voor ATEX Zone II 2G

Geleverd met:

- Vernevelaar (nareiniging)
- Zijtafel (links en rechts monteerbaar)

Order nr.		754720003
Orig. nr.		RVP160
Werking		pneumatisch
Type		conventionele lakken
Reinigingsproduct		verdunner
Vaten		2x30 l
Diameter afvoerbus	mm	120
Gewicht	kg	40,00
Afmetingen (l x b x h)	mm	790 x 690 x 1385
Prijs	€	1.159,00

	DEG160	RFU	Eco P.N.
verkrijgbaar in	5, 25, 60, 210L	25, 60L	5, 25 L
type	solvent	waterbasis	waterbasis
toepassing	onverdund	onverdund	verdund
RVP177X, RVP165 (unit watergedragen lakken)	niet geschikt	niet geschikt	geschikt



SOLVENT
WATER
AUTOMATIC



CE Ex II 2GD

Pneumatische verfspuitpistolen reiniger voor solvent gedragen lakken - manueel + automatisch

Werking

- Automatische reiniging met herbruikbare verdunner, aangedreven door eerste membraanpomp
- Of handmatige reiniging met herbruikbare verdunner aangedreven door eerste membraanpomp
- Nareiniging met zuivere verdunner, aangedreven door tweede membraanpomp

Kenmerken

- Eenvoudige en gebruiksvriendelijke bediening
- Mogelijk om 2 pistolen tegelijkertijd te reinigen
- Met automatische dampafziging
- Tijdschakelaar met automatische reiniging
- Ruimte onderaan voor 1 vat van 30 l en 1 vat van 60 l
- Drukregelaar voor kleurtesten
- Inclusief ATEX/VEXAT certificaat voor ATEX Zone II 2G

Inclusief

- Vernevelaar (nareiniging)

Order nr.	754720004 €
Orig. nr.	RVP180B
Werking	pneumatisch
Type	Conventionele lakken
Totale inhoud tank	l 2x30
Pomp	2 venturipompen
Gewicht	kg 74,00
Afmetingen (l x b x h)	mm 710 x 685 x 1500
Prijs	€ 2.795,00



Geconcentreerd vloeibaar reinigingsproduct met een bijzonder hoog percentage aan actieve ingrediënten, waardoor het zeer geschikt is voor het reinigen en ontvetten van vette en met olie vervuilde oppervlakken of andere (atmosferische) verontreinigingen. Verwijderd eveneens inkresten, pigmenten, voedingsresten,...

Kenmerken:

- Geconcentreerd product, dus economisch in gebruik
- Alkalisch (pH 12,5)
- Biologisch afbreekbaar
- Densiteit 1,045
- Volledig oplosbaar in water
- Bruikbaar in voedingsindustrie

Toepassing: Verdunnen met water tot max. 1:100, afhankelijk van de aard en mate van vervuiling.

Order nr.	754725008	754725009	754725011
Orig. nr.	ECOPLUS5	ECOPLUS25	ECOPLUS60
Omschrijving	reinigingsproduct	reinigingsproduct	reinigingsproduct
Inhoud	l 5	25	60
Gewicht	kg 5,00	25,00	63,00
Prijs	€ 18,50	71,90	159,00



Afscheiding kit verf/water voor verfpistolenreinigers.

Order nr.	754720012 €
Orig. nr.	R110
Voor model	RVP177X - RVP920WX - RVP165
Gewicht	kg 42,00
Prijs	€ 295,00



5 kleine filterzakken voor afscheiding water/verf.

Order nr.	754720013 €
Orig. nr.	RW50
Voor model	RVP177X - RVP920X - RVP165
Gewicht	kg 1,00
Prijs	€ 24,90



Grote filterzak voor afscheiding water/verf. Geschikt voor RVP165 en RVP177X.

Order nr.	754720014 €
Orig. nr.	RW51
Voor model	RVP177X - RVP920X - RVP165
Gewicht	kg 1,00
Prijs	€ 24,90

MACH



Coagulatie poeder voor afscheiding water/
verf.

Order nr.	754720021 €
Orig. nr.	RFL02
Voor model	RVP177X - RVP920X - RVP165
Gewicht	kg 1,50
Prijs	€ 49,90

TOOLS



Vernevelaar.

Geschikt voor:

- Het afzuigen en vernevelen van niet-toxische detergents, lage dichtheid olieën (40-60 °C) en dergelijke.
- Met de VS30 kan er zeer fijn verneveld worden op het te behandelen oppervlak, waardoor er kan bespaard worden aan reinigingsmiddel zonder aan reinigingskracht in te boeten.

Toepassingen:

- Reinigen van voertuigen
- Smeren
- Etc.

Kenmerken en voordelen:

- Werkt autonoom, zonder constant geconnecteerd te zijn aan luchtdruktoevoer
- Met trechter voor het snel en eenvoudig vullen
- Met tooltray bovenaan de tank
- Met overdrukventiel

Order nr.	724562003 €
Orig. nr.	VS30
Capaciteit tank	l 30
Luchttoevoer	bar 6
Luchtverbruik	l/min 200
Lengte vernevelsput	mm 620
Lengte slang	m 5
Inwendige diameter slang	mm 6,5
Uitwendige diameter slang	mm 10
Aansluiting luchttoevoer	inch 1/4
Gewicht	kg 13,50
Prijs	€ 129,00

TOOLS



Schuimunit om verschillende reinigingsmiddelen (shampoo, ontvetter, desinfectie) te schuimen op het te behandelen oppervlak.

Het reinigingsmiddel wordt vermengd met perslucht, zodat schuim ontstaat. Het kleverige karakter van het schuim zorgt ervoor dat het reinigingsmiddel gedurende langere tijd actief op de verontreiniging kan inwerken.

Geleverd met:

- Shuimstang
- Trechter voor het snel en eenvoudig vullen

Standaard geleverd zonder vernevel- of schuimlans.

Order nr.	724562001 €
Orig. nr.	FS30
Capaciteit tank	l 30
Luchttoevoer	bar 5-6
Luchtdrukaansluiting (snellkoppeling)	inch 1/4
Werkdruk	bar 2,5-3
Lengte foamsput	mm 700
Inwendige diameter foam spuit	mm 10,5
Uitwendige diameter foam spuit	mm 12,5
Lengte slang	m 5
Inwendige diameter slang	mm 6,5
Uitwendige diameter slang	mm 10
Trechter	✓
Gewicht	kg 13,50
Prijs	€ 119,00

EQUIPMENT

Ultrasoonreinigers

De ultrasoonreiniger maakt gebruik van ultrasone geluidsgolven om **alle soorten materiaal te reinigen**. Trillingen worden met een hoge frequentie overgebracht aan de reinigingsvloeistof, waardoor de kleinste vuildeeltjes op de meest ontoegankelijke plaatsen worden losgeweekt.

De voordelen van ultrasoonreinen:

- Gebruiksgemak: het reinigingsproces heeft minder menselijke interventie nodig
- Resultaat: precieze reining, ook op moeilijk bereikbare plaatsen
- Economisch: kortere reinigingscyclus, minder menselijke interventie nodig
- Milieuvriendelijk: minder reinigingsproducten nodig, beperkt afvalwater

Enkele toepassingen:

- **Automotive:** Cilinderkoppen, diesel injectie leidingen, brandstofpomp behuizingen, injectoren, cilindervoeringen, uitlaten, ontluuchtingsleidingen, compressorleidingen, spiegel onderdelen, sensoren ABS, carburateurs, etc.
- **Machines en gereedschappen:** Drukvormen, matrijzen, snijgereedschap, schuifmaten, micrometers, meetgereedschappen, frezen, boren, zagen, draaibeitels, etc.
- **Houtbewerking:** Cirkelzagen, zaagbladen, frezen



Digitale ultrasoonreiniger.

Belangrijke eigenschappen:

- Afvoer kraan
- Timer 1-99 min
- Temperatuursregeling (tot 80°C)
- Met roestvrij stalen tankdeksel en mand



Order nr.	754750069	
Orig. nr.	UCL006	
Inhoud	l	6
Ultrasoon vermogen	W	180
Verwarming vermogen	W	150
Totaal vermogen	W	330
Afmetingen inwendig (l x b x h)	mm	300x155x150
Timer	min	1-99
Maximum temperatuur	°C	80
Frequentie	kHz	40
Gewicht	kg	8,00
Afmetingen (l x b x h)	mm	300 x 155 x 150
Prijs	€	299,00



Digitale ultrasoonreiniger

Belangrijke eigenschappen:

- Afvoer kraan
- Timer 1-99 min
- Temperatuursregeling (tot 80°C)
- Met roestvrij stalen tankdeksel en mand



Order nr.	754750071	
Orig. nr.	UCL022	
Inhoud	l	22
Ultrasoon vermogen	W	500
Verwarming vermogen	W	475
Totaal vermogen	W	975
Afmetingen inwendig (l x b x h)	mm	500x300x150
Timer	min	1-99
Maximum temperatuur	°C	80
Frequentie	kHz	40
Gewicht	kg	16,50
Afmetingen (l x b x h)	mm	500 x 300 x 150
Prijs	€	809,00



Digitale ultrasoonreiniger

Belangrijke eigenschappen:

- Afvoer kraan
- Timer 1-99 min
- Temperatuursregeling (tot 80°C)
- Met roestvrij stalen tankdeksel en mand



Order nr.	754750070	
Orig. nr.	UCL010	
Inhoud	l	10
Ultrasoon vermogen	W	240
Verwarming vermogen	W	285
Totaal vermogen	W	525
Afmetingen inwendig (l x b x h)	mm	300x240x150
Timer	min	1-99
Maximum temperatuur	°C	80
Frequentie	kHz	40
Gewicht	kg	10,00
Afmetingen (l x b x h)	mm	300 x 240 x 150
Prijs	€	489,00



Digitale ultrasoonreiniger

Belangrijke eigenschappen:

- Afvoer kraan
- Timer 1-99 min
- Temperatuursregeling (tot 80°C)
- Met roestvrij stalen tankdeksel en mand



Order nr.	754750072	
Orig. nr.	UCL030	
Inhoud	l	30
Ultrasoon vermogen	W	500
Verwarming vermogen	W	475
Totaal vermogen	W	975
Timer	min	1-99
Maximum temperatuur	°C	80
Frequentie	kHz	40
Gewicht	kg	19,00
Afmetingen (l x b x h)	mm	500 x 300 x 200
Prijs	€	875,00



Digitale ultrasoonreiniger

Belangrijke eigenschappen:

- Afvoer kraan
- Timer 1-99 min
- Temperatuursregeling (tot 80°C)
- Met roestvrij stalen tankdeksel en mand

Order nr.	754750073 €	
Orig. nr.	UCL060	
Inhoud	l	60
Ultrasoon vermogen	W	1000
Verwarming vermogen	W	1500
Totaal vermogen	W	2500
Afmetingen inwendig (l x b x h)	mm	500x400x300
Timer	min	1-99
Maximum temperatuur	°C	80
Wielen		✓
Frequentie	kHz	28
Gewicht	kg	65,00
Afmetingen (l x b x h)	mm	500 x 400 x 300
Prijs	€	2.055,00



Digitale ultrasoonreiniger met afvoer kraan en timer 1-99 min en temperatuursregeling (tot 80°C). Maakt gebruik van ultrasone geluidsgolven om **alle soorten materiaal te reinigen**. Met roestvrij stalen tankdeksel en mand.

Reiniger vanaf inhoud 60 liter: op wielen.

Order nr.	754750076 €	
Orig. nr.	UCL072T	
Inhoud	l	72
Ultrasoon vermogen	W	1800
Verwarming vermogen	W	1500
Totaal vermogen	W	3300
Afmetingen inwendig (l x b x h)	mm	600x400x300
Timer	min	1-99
Maximum temperatuur	°C	80
Wielen		✓
Frequentie	kHz	28
Gewicht	kg	30,00
Afmetingen (l x b x h)	mm	600 x 400 x 300
Prijs	€	2.499,00

REINIGINGSPRODUCTEN
p. 439



	DEG160	RFU	Eco P.N.
verkrijgbaar in	5, 25, 60, 210L	25, 60L	5, 25 L
type	solvent	waterbasis	waterbasis
toepassing	onverdund	onverdund	verdund
Ultrasoonreinigers (modellen UCL, UCTT, UCMOT)	niet geschikt	minder geschikt	geschikt



Digitale ultrasoonreiniger met afvoer kraan en timer 1-99 min en temperatuursregeling (tot 80°C).

Order nr.	754750077 €	
Orig. nr.	UCL120	
Inhoud	l	120
Ultrasoon vermogen	W	2000
Verwarming vermogen	W	3000
Totaal vermogen	W	5000
Afmetingen inwendig (l x b x h)	mm	600x500x300
Timer	min	1-99
Maximum temperatuur	°C	80
Wielen		✓
Frequentie	kHz	28
Gewicht	kg	30,00
Afmetingen (l x b x h)	mm	600 x 500 x 300
Prijs	€	2.999,00

EQUIPMENT



Professionele ultrasoonreiniger 400L, geschikt voor autoreparaties, scheepsmotoren, warmtekrachtkoppeling, de ruimtevaart en het herstellen en reviseren van motoren.

De UCMOT ultrasoonreiniger garandeert een hoogwaardige reiniging, waarbij elk type aanslag effectief wordt verwijderd, zoals vet, olie of koolstof.

Voordelen tegenover gewone reiniging:

- Gebruiksgemak: het reinigingsproces heeft minder menselijke interventie nodig
- Resultaat: precieze reiniging, ook op moeilijk bereikbare plaatsen
- Economisch: kortere reinigingscyclus, minder menselijke interventie nodig
- Milieuvriendelijk: besparing water en detergent. Geïntegreerd vuilafvoersysteem

Toepassingen:

De UCMOT reinigers leveren uitstekende resultaten in het ultrasoon reinigen van auto-onderdelen. Olie, vet en roet worden snel en efficiënt verwijderd. Deze lijn is speciaal ontworpen om alle soorten motoronderdelen te reinigen, zoals motorblokken, cilinderkoppen, turbo's, injectoren, roetfilters, alsook remmen, versnellingsbakken, radiatoren, transmissiesystemen, etc.

Belangrijke eigenschappen:

- Tank uit AISI 316 Roestvrij staal, 2-2.5mm dik
- Met 10-30 mm dikke thermo-akoustische isolatie
- Geïntegreerde handvaten op extern paneel
- afvoerkraan
- Geïsoleerd deksel op gasveer
- Controlepaneel
- incl. timer, temperatuur- en vermogensregeling, en ontgassingsysteem.
- In- en uitladen: pneumatisch liftplatform
- Geïntegreerd vloei- en overloopsysteem(waterflow) om olie en ander drijvend vuil te verwijderen
- Luchtpistool om onderdelen te drogen
- In hoogte verstelbare voeten
- Kraan met 1/2" aansluiting voor watertoevoer

Order nr.		754750116
Orig. nr.		UCMOT400N
Belastbaarheid werkblad	kg	250
Spanning	V	400
Inhoud	l	400
Ultrasoon vermogen	W	3400
Piekvermogen	W	6800
Verwarming vermogen	W	7000
Totaal vermogen	W	13800
Afmetingen inwendig (l x b x h)	mm	1100 x 650 x 690
Afmetingen mand/platform (l x b x h)	mm	1050 x 495
Nuttige afmetingen (l x b x h)	mm	1050 x 495 x 395
Timer	min	1-99
Frequentie	kHz	40
Gewicht	kg	320,00
Afmetingen (l x b x h)	mm	1540 x 890 x 1070
Prijs	€	25.050,00

Zandstraalcabines





Mobiele zandstraalketel om o.a. roest en oude laklagen te verwijderen. Inhoud 75 l.

Troeven:

- Dankzij de trechtervorm, kan straalmiddel eenvoudig en zonder morsen in de ketel gegoten worden.
- Dankzij de stevige wielen en handvaten, kan de zandstraler eenvoudig verplaatst worden, ook wanneer hij vol is.
- Ook de 2.5 m lange slang zorgt voor een goede mobiliteit.

Geleverd met beschermmasker en verwisselbare koppen.

Order nr.	754750025 	
Orig. nr.	CAT020RA	
Capaciteit	l	75
Lengte slang	m	2,5
Inw. diam. straalslang	mm	11,5
Inhoud	l	75
Werkdruk en luchtverbruik	4,5 - 8,6 bar (170-700l/min)	
Gewicht	kg	25,00
Afmetingen (l x b x h)	mm	420 x 560 x 890
Prijs	€	199,00



Zandstraalcabine 90 l, tafelmodel.

Troeven:

- Bescherming van de handen door de zware handschoen
- Geïntegreerde lamp
- Stalen cabine
- Kijkscherm uit verhard glas

Geschikt voor:

- Glaskorrels
- Siliciumzand
- Aluminiumoxide
- Normaal Korund

Inclusief:

- Straalpistool
- Keramische koppen 4, 5, 6 en 7mm

Order nr.	754751210 		
Orig. nr.	CAT210		
Maximum werkdruk	bar	8,6	
Binnenafmetingen (l x b x h)	mm	560x460x280	
Afmetingen kijkvenster	mm	488x395	
Afmetingen laaddeur	mm	490x390	
Gewicht	kg	28,00	
Afmetingen (l x b x h)	mm	460 x 710 x 690	
Prijs	€	149,00	



TOOLS



Zandstraalcabine 220 l, voetmodel

Troeven:

- Afvoeropening voor het verwijderen van het sableerzand
- Gemakkelijk om grotere materialen te reinigen via de grote zijdeur
- Bescherming van de handen door de zware handschoen
- Geïntegreerde lamp
- Stalen cabine
- Kijscherm uit verhard glas

Geschikt voor:

- Glasparels
- Siliciumzand
- Aluminiumoxide
- Normaal Korund

Inclusief:

- Straalpijstool
- 4 keramische straalkoppen (4mm, 5mm, 6mm en 7mm)

Order nr.	754751410 €	
Orig. nr.	CAT410	
Capaciteit	l	220
Maximum werkdruk	bar	8,6
Luchtverbruik @ 8 bar	l/min	680
Binnenafmetingen (l x b x h)	mm	860x560x560
Afmetingen kijkvenster	mm	565x268
Afmetingen laaddeur	mm	510x(240-420)
Gewicht	kg	48,00
Afmetingen (l x b x h)	mm	900 x 570 x 1400
Prijs	€	369,00

TOOLS



Zandstraalcabine voor middelgrote werkzaamheden 340-420 l met stofafzuiging.

Troeven:

- Afvoeropening voor het verwijderen van het sableerzand
- Bescherming van de handen door de zware handschoen
- Geïntegreerde lamp
- Stalen cabine
- Kijscherm uit verhard glas
- Max. werkdruk 8.6 bar
- Drukregelaar met manometer
- Voetpedaal voor eenvoudige bediening
- Snel en gemakkelijk te laden door 2 zijdeuren + 1 frontdeksel

Geschikt voor:

- Glasparels
- Siliciumzand
- Aluminiumoxide
- Normaal Korund

Geleverd met:

- Hoge kwaliteit latex handschoenen
- Verlichting in afzonderlijke behuizing
- Beschermglas en vervangbare beschermfolie inclusief 5 reserve films voor verlichting en 5 voor raam
- Afzuiging met microfilter
- Straalpijstool met keramische koppen 2x6mm + 2x7mm.

Order nr.	754751442 €	
Orig. nr.	CAT420	
Capaciteit	l	420
Maximum werkdruk	bar	8,6
Luchtverbruik @ 8 bar	l/min	680
Binnenafmetingen (l x b x h)	mm	1210 x 600 x 360-580
Afmetingen kijkvenster	mm	574x268
Spanning	V	230
Gewicht	kg	122,00
Afmetingen (l x b x h)	mm	900 x 1300 x 1700
Prijs	€	1.119,00

TOOLS



Professionele zandstraalcabine 990 l met stofafzuiging.

Troeven:

- Afvoeropening voor het verwijderen van het sableerzand
- Bescherming van de handen door de zware handschoen
- Geïntegreerde lamp
- Stalen cabine
- Kijkscherm uit verhard glas
- Max werkdruk 8,6 bar
- Drukregelaar met manometer
- Voetpedaal voor eenvoudige bediening

Geschikt voor:

- Glasparels
- Siliciumzand
- Aluminiumoxide
- Normaal Korund

Geleverd met:

- Paar hoge kwaliteit latex handschoenen
- 4 fluorescerende werklampen van 26 Watt
- 5 beschermfolies voor raam en lampen
- Afzuiging met microfilter
- Straalpijstool met keramische koppen 2 x 6 mm + 2 x 7 mm

Order nr.	754751990	
Orig. nr.	CAT990	
Capaciteit	l	990
Maximum werkdruk	bar	8,6
Luchtverbruik @ 8 bar	l/min	680
Binnenafmetingen (l x b x h)	mm	1180 x 880 x 860
Afmetingen kijkvenster	mm	694x324
Afmetingen laaddeur	mm	750x960
Spanning	V	230
Gewicht	kg	160,00
Afmetingen (l x b x h)	mm	1240 x 1320 x 1760
Prijs	€	1.449,00

TOOLS



DUBBEL



Professionele dubbele zandstraalcabine 1200 l met stofafzuiging. Geschikt voor grote stukken.

Troeven:

- 2 deuren, geschikt om grote stukken te laden
- 2 staalpijstolen, zodat 2 personen simultaan kunnen stralen
- Afvoeropening voor het verwijderen van het sableerzand
- Bescherming van de handen door de zware handschoenen
- Geïntegreerde lamp
- Stalen cabine
- Kijkscherm uit verhard glas
- Max. werkdruk 8,6 bar
- Drukregelaar met manometer
- Voetpedaal voor eenvoudige bediening

Geschikt voor:

- Glasparels
- Siliciumzand
- Aluminiumoxide
- Normaal korund

Geleverd met:

- 2 straalpijstolen met keramische koppen 2 x 6 mm + 2 x 7 mm
- 2 paar hoge kwaliteit latex handschoenen
- 4 fluorescerende werklampen van 26 Watt
- 5 beschermfolies voor raam en lampen
- Afzuiging met microfilter

Order nr.	754751579	
Orig. nr.	CAT1200	
Capaciteit	l	1200
Capaciteit zand	l	32
Inhoud	l	1200
Werkdruk	bar	8,6
Luchtverbruik @ 8 bar	l/min	680
Binnenafmetingen (l x b x h)	mm	1180x1300x850
Afmetingen kijkvenster	mm	(2x) 694x324
Afmetingen laaddeur	mm	(2x) 750x960
Spanning	V	230
Gewicht	kg	180,00
Afmetingen (l x b x h)	mm	1180 x 1300 x 1770
Prijs	€	2.099,00

EQUIPMENT



Handstraler met opvangzak om punt- en pleksgewijs roest en oude laklagen te verwijderen.

Geschikt voor:

- Aluminium oxide en glasparels voor meermalig gebruik, of aluminium silicaat voor eenmalig gebruik
- Te gebruiken met een compressor

Kenmerken:

- Licht, ergonomisch, eenvoudig te gebruiken
- Opvangzak voor staalmiddel

Geleverd met 4 rubberen adapters (rond, plat, binnenhoek, buitenhoek), die tegen het te stralen oppervlakte geplaatst kunnen worden

Order nr.	754750064
Orig. nr.	CATMS4
Inhoud	l 0,9
Maximum werkdruk	bar 6,7
Luchtverbruik @ 3 bar	l/min 150
Aansluiting	inch 1/4
Gewicht	kg 0,83
Prijs	€ 44,50



Beschermkap voor zandstralen.

Order nr.	754750020
Orig. nr.	CATSBH
Gewicht	kg 5,00
Afmetingen (l x b x h)	mm 470 x 300 x 560
Prijs	€ 19,90



Glasparel voor het **stralen met straalcabine 100-200 µm van 25 kg.**

Voor het reinigen, behandelen en afwerken van metaal en andere materialen. Volle glazen microsferen met een glad en glanzend oppervlak.

Geschikt voor:

- Ontbramen, voorbehandeling en finishing van stukken uit metaal of kunststof zoals spuitgietstukken, gereedschappen, mechanische precisiestukken, auto-onderdelen. Ideaal voor het satineren en het uitvoeren van decoratieve straalwerken in het algemeen.
- Algemene reiniging van non-ferro of ferro constructies en stukken zoals snijgereedschappen, schroefdraden, vormen uit de glas-, rubber- en kunststofindustrie, extrusiematrijzen uit de aluminiumijverheid, motoronderdelen, onderdelen van pompen en compressoren,...
- Shotpeening van mechanische elementen en assemblages zoals: schoepen, turbine-assen en -onderdelen, gelaste constructies, tanks en buizen, tandwielen, reductoren,...

Voordelen:

- Minimale aantasting door perfecte bolvormige korrel
- Laag afbreekgehalte (hoge elasticiteit)
- Uitstekende reiniging van het oppervlak
- Chemisch inert, silicium- en ijzervrij

Order nr.	96020801
Orig. nr.	SBL125
Materie	Glasparels
Oorsprong	mineraal neutraal
Bulkgewicht	kg/l 1,5
Hardheid	Mohs 6
Korrelgrootte	µm 100-200
Hardheid	Hrc 47
Korrelvorm	sterisch
Aantal recyclages	5-35
Gewicht	kg 25,00
Prijs	€ 48,50

TOOLS



Straalmiddel **33 kg voor éénmalig gebruik.**

Hoekige korrel voor o.a. ontroesten, ontpakken en opruimen van metalen. Harde en scherpe microkorrels, tot stand gebracht door een gecontroleerd smeltproces bij hoge temperatuur van een masse bestaande uit aluminium silicaat glas.

Geschikt voor:

- Ontlakken, ontroesten en opruimen van metalen oppervlakten ter bevordering van de hechting bij het aanbrengen van verflagen of andere nabehandelingen

Voordelen:

- Stabiel en betrouwbaar product (geen afval uit productieproces zoals vb. slakken)
- Bevat geen schadelijke stoffen

Order nr.	96020802 €
Orig. nr.	SBL225
Materie	rugos
Oorsprong	mineraal neutraal
Bulkgewicht	kg/l 1,3
Hardheid	Mohs 6-7
Korrelgrootte	µm 100-630
Korrelvorm	massif kantig
Aantal recyclages	0
Gewicht	kg 33,00
Prijs	€ 30,50

TOOLS



Straalmiddel **normaal korund 25 kg.**

Kantige en massieve korrel (eerste kwaliteit, hoge zuiverheid)

Geschikt voor:

- Het opruwen van allerlei oppervlakten alvorens te metalliseren, vulkaniseren, emaileren, coaten of aanbrengen van andere deklagen.
- Matternen van metalen, glas, spiegels, natuursteen,...

Voordelen:

- Groot recyclagevermogen (taaië korrel door gehalte aan titaan)
- Inert, silicium- en ijzervrij (gehalte Fe₂O₃ 0.1%)

SBL325 of SBL315?

- SBL325 heeft een iets zwaardere korrel dan SBL315. Dit zal resulteren in een agressievere maar minder continue flow (eerder in "stoten").
- SBL315 zal een continue flow leveren, maar zal iets minder aggressief stralen.

Order nr.	96020804 €	96020803 €
Orig. nr.	SBL315	SBL325
Materie	Normaal Korund	Normaal Korund
Oorsprong	mineraal neutraal	mineraal neutraal
Bulkgewicht	kg/l 1,63-1,73	2
Hardheid	Mohs 9	9
Fepa norm	F090	
Korrelgrootte	µm 149	210-300
Hardheid	Hrc 70	70
Korrelvorm	Kantig	Kantig
Aantal recyclages	1225	1225
Gewicht	kg 25,00	25,00
Prijs	€ 54,90	52,50

EQUIPMENT

Reinigingstoestellen

TOOLS



Beschermfolie voor het kijkvenster en het venster van verlichting van zandstraalcabines.

Order nr.	754751451 €	754751471 €	754751536 €
Orig. nr.	CATSF4940	CATSF5727	CATSF7032
Voor type	CAT210	CAT410 - CAT420	CAT990 - CAT1200
Gewicht kg	0,10	0,10	0,30
Afmetingen (l x b x h) mm	530 x 250 x 1	574 x 268 x 1	694 x 324 x 1
Prijs €	9,90	2,50	2,50

TOOLS



Pistool voor zandstraalketel CAT020RA.

Order nr.	754750027 €
Orig. nr.	CATSP2035
Voor type	CAT020RA
Gewicht kg	0,50
Prijs €	34,50

TOOLS



Pistool voor zandstraalcabines CAT210 en CAT410.

Order nr.	754751452 €
Orig. nr.	CATSP4070
Voor type	CAT210 - CAT410
Gewicht kg	0,80
Prijs €	34,50

TOOLS



Pistool voor zandstraalcabines CAT420, CAT990 en CAT1200.

Order nr.	754751531 €
Orig. nr.	CATSP6070
Voor type	CAT420 - CAT990 - CAT1200
Gewicht kg	0,80
Prijs €	54,90

TOOLS



Set van 4 keramische koppen.

Order nr.	754750041 €
Orig. nr.	CATSN2035
Voor type	CAT020RA
Maten mm	2 - 2,5 - 3 - 3,5
Gewicht kg	0,40
Prijs €	9,90

TOOLS



Set van 4 keramische koppen voor sableercabines CAT210 en CAT410.

Order nr.	754751453 €
Orig. nr.	CATSN4070
Voor type	CAT210 - CAT410
Maten mm	4 - 5 - 6 - 7
Gewicht kg	0,40
Prijs €	10,50

TOOLS



Set van 4 keramische koppen voor zandstraalcabines CAT420, CAT990 en CAT1200.

Order nr.	754751522 €
Orig. nr.	CATSN6070
Voor type	CAT420 - CAT990 - CAT1200
Maten mm	6 - 6 - 7 - 7
Gewicht kg	0,40
Prijs €	11,50

TOOLS



Zandstraalhandschoenen om te zandstralen.

Order nr.	754751459 €	754751467 €	754751517 €	754751546 €
Orig. nr.	CATSG210	CATSG410	CATSG420	CA-TSG990/1200
Voor type	CAT210	CAT410	CAT420	CAT990 - CAT1200
Gewicht kg	0,30	0,30	0,30	0,30
Prijs €	15,90	16,50	16,50	21,90

TOOLS



Vervangend beschermglas voor CATSBH.

Order nr.	754750059 €
Orig. nr.	CATSBH-GLASS
Gewicht kg	0,10
Prijs €	3,20

TOOLS



Vervangend beschermgaasje voor CATSBH.

Order nr.	754750060 €
Orig. nr.	CATSBH-MG
Gewicht kg	0,10
Prijs €	2,20



Soda straalkit om straalketel om te bouwen naar een soda straalketel. Om te stralen met natriumbicarbonaat (zachte manier van stralen).

Voordelen van stralen met natriumbicarbonaat:

- Niet schadelijk voor het milieu
- Verwijdert verf op metaal, glasvezel, kunststof, rubber, glas, chroom, ... zonder het materiaal aan te tasten of te vervormen
- Hierdoor dienen er weinig voorbereiding te gebeuren (vb afplakken) alvorens het stralen.

Ideaal voor:

- Het ontvetten en verwijderen van verf op motoronderdelen, carburators, hydraulische onderdelen, ...
- Gevelreiniging en graffiti verwijdering
- Strippen van auto onderdelen
- Velgen
- Verf verwijderen van meubelen
- Terrassen (tegels/hout)
- Voedingsindustrie

Order nr.	754750066 €
Orig. nr.	CATSDB
Voor type	zandstraalketel CAT020RA
Gewicht	kg 0,90
Prijs	€ 43,90



Stofzuiger voor zandstraalcabines.

Order nr.	754751443 €
Orig. nr.	CATDC
Oppervlakte filter	m ² 2,35
Capaciteit ventilator	m ³ /h 3,8
Gewicht	kg 9,00
Afmetingen (l x b x h)	mm 780 x 300 x 320
Prijs	€ 156,00



Zichtvenster voor zandstraalcabine CAT210.

Order nr.	754751451 €
Orig. nr.	CATSF4940
Voor type	CAT210
Gewicht	kg 0,50
Afmetingen (l x b x h)	mm 488 x 395 x 1
Prijs	€ 29,90

Zandstraalcabines voor het verwijderen van roest en verf

Verwijder roest en verf met de krachtige zandstraalcabines van MW Tools. Ideaal om motorfietsen, auto's en boten te restaureren, of houten meubels en balken op te frissen. Door te zandstralen verwijdert u gemakkelijk oude vernislagen op meubilair of ondoet u zonder moeite alle verf of roest van uw boot, auto of motor. Dit proces is veel sneller dan een schraper of borstel. Zo krijgt u terug een opgefrist meubel of blank metaal, dat u opnieuw naar wens kunt schilderen.

Kleine en grote zandstraalcabines voor het reinigen van onderdelen

MW Tools biedt een breed assortiment zandstraalcabines aan met verschillende vermogens en capaciteiten. Dankzij de combinatie van poederlak en stevig plaatstaal, zijn onze sableercabines geschikt voor zowel industrie als vrije tijd, voor garages en werkplaatsen. Kleine zandstralers kunnen makkelijk op een werkbank geplaatst worden en eenvoudig verplaatst worden. Afhankelijk van de grootte van het te reinigen onderdeel, heeft u een grotere zandstraalcabine nodig. Mobiele zandstraalketels zijn ideaal voor het schoonmaken van grotere of losse elementen, bv. de bodem van een boot, de carrosserie van uw auto of de gevel van uw huis, eiken balken of houten meubels.

Straalmiddel voor zandstraalketels en zandstraalcabines

Bij zandstralen wordt het straalmiddel of straalgrit met hoge snelheid tegen het voorwerp geblazen, om het onderdeel of de oppervlakte schoon te maken. VYNCKIER biedt verschillende soorten straalmiddel aan:

- Ronde, herbruikbare glasparel voor de reiniging van zachte metalen zoals aluminium. Voor een fijnere, gepolijste afwerking.
- Normaalkorund: hoekige, herbruikbare korrel voor het ontroesten en ontlakken van metalen. Iets grovere afwerking.
- Aluminium silicaat: hoekige korrel voor eenmalig gebruik voor het ontroesten van metalen. Meest geschikt voor mobiele zandstraalketels.

Accessoires

Alle straalcabines van MW Tools worden volledig en gebruiksklaar geleverd. Daarnaast hebben we ook accessoires voor uw zandstraalketel of -cabine, zoals keramische en Tungsten koppen, handschoenen, beschermkap met vervangbare gaasjes, straalgrit, enzovoort.

Kies in een paar klikken uw geschikte zandstraalcabine en extra accessoires op vynckier.biz. Vergeet niet om ook een compressor uit te zoeken.



Stof- & waterzuigers

cleancraft



NEW

Dragbare en ultracompacte stofzuiger met filterreiniging.

Kenmerken:

- Compact en draagbaar met schouderband
- Filterreiniging via "easy push"
- Geschikt voor droge toepassing
- Geleverd met flexibele aanzuigslang en borstelset met houder

Order nr.	717003110 €	
Orig. nr.	FLEXCAT 16 H	
Spanning	V	230
Frequentie	Hz	50
Vermogen motor	kW	1,2
Aantal motoren		1
Aantal trappen		1
Koeling		doorstroom
Tankinhoud	l	6
Tankmateriaal		kunststof
Lengte slang	m	1
Diameter slang	mm	35
Geluidsniveau	dB(A)	72,6
Luchtdebiet	l/min	1800
Kabel lengte	m	4,5
Gewicht	kg	4,00
Afmetingen (l x b x h)	mm	290 x 240 x 430
Prijs	€	84,00



cleancraft



NEW

Dragbare en bijzonder geluidsarme stofzuiger met hoge filtercapaciteit.

Kenmerken:

- Zeer stil: slechts 57 dB
- Compact en licht
- Hoge efficiëntie en groot filteroppervlak
- Geschikt voor droge toepassing
- Geleverd met flexibele aanzuigslang, 2 instelbare buizen en set borstels

Order nr.	717003120 €	
Orig. nr.	FLEXCAT 112 Q	
Spanning	V	230
Frequentie	Hz	50
Vermogen motor	kW	1,3
Aantal motoren		1
Aantal trappen		1
Koeling		doorstroom
Tankinhoud	l	12,5
Tankmateriaal		kunststof
Lengte slang	m	2
Diameter slang	mm	36
Geluidsniveau	dB(A)	57
Luchtdebiet	l/min	3500
Kabel lengte	m	8,5
Gewicht	kg	9,00
Afmetingen (l x b x h)	mm	400 x 400 x 510
Prijs	€	149,00

cleancraft



Industriële nat- en droogzuiger voor vloeistoffen, vetten, spaanders, enz.

Kenmerken:

- Met stekkerdoos 230 V/2300 W voor aansluiten van power tools
- Kopergewikkelde motoren met thermische veiligheid, made in EU
- Dichtingen zijn bestand tegen oliën
- Instelbare aluminium buizen met kunststof omwikkeld: licht en zeer stevig
- Flexibele slang met zeer hoge druk- en dwaaiweerstand
- Nylonklemmen op de tank bestand tegen verdraaiing en stoten
- Slimme kabelhaak op de kop

Order nr.		717001120 €
Orig. nr.		WETCAT 116 E
Spanning	V	230
Frequentie	Hz	50
Vermogen motor	kW	1,3
Aantal motoren		1
Aantal trappen		1
Koeling		bypass
Tankinhoud	l	16
Tankmateriaal		kunststof
Filteroppervlak	cm²	1250
Lengte slang	m	2
Diameter slang	mm	36
Geluidsniveau	dB(A)	71,2
Stopcontacten maximum vermogen	W	2300
Luchtdebiet	l/min	3333
Onderdruk	mbar	238
Kabel lengte	m	8,5
Gewicht	kg	10,40
Afmetingen (l x b x h)	mm	400 x 400 x 640
Prijs	€	159,00

cleancraft



Industriële nat- en droogzuigers voor vloeistoffen, vetten, spaanders, enz.

Kenmerken:

- Met stekkerdoos 230 V/2300 W voor aansluiten van power tools
- Kopergewikkelde motoren met thermische veiligheid, made in EU
- Dichtingen zijn bestand tegen oliën
- Instelbare aluminium buizen met kunststof omwikkeld: licht en zeer stevig
- Flexibele slang met zeer hoge druk- en dwaaiweerstand
- Nylonklemmen op de tank bestand tegen verdraaiing en stoten
- Slimme kabelhaak op de kop
- 2-traps motor voor het zwaardere werk
- Stofzuiger schakelt automatisch in bij inschakelen van de aangesloten power tool
- Model 133 IR met inox tank

Order nr.		717001140 €	717001145 €
Orig. nr.		WETCAT 137 R	WETCAT 133 IR
Spanning	V	230	230
Frequentie	Hz	50	50
Vermogen motor	kW	1,3	1,3
Aantal motoren		1	1
Aantal trappen		2	2
Koeling		bypass	bypass
Tankinhoud	l	37	33
Tankmateriaal		kunststof	inox
Filteroppervlak	cm²	1490	1490
Lengte slang	m	4	4
Diameter slang	mm	38	38
Geluidsniveau	dB(A)	72	72
Stopcontacten maximum vermogen	W	2300	2300
Luchtdebiet	l/min	3333	3333
Onderdruk	mbar	247	247
Kabel lengte	m	8,5	8,5
Gewicht	kg	12,30	15,00
Afmetingen (l x b x h)	mm	390 x 390 x 900	430 x 430 x 830
Prijs	€	245,00	259,00

EQUIPMENT

cleancraft



Industriële nat- en droogzuiger voor vloeistoffen, vetten, spaanders, enz.

Kenmerken:

- Inox tank
- Stekkerdoos 230 V / 1150 W voor power tools, stofzuiger schakelt automatisch in bij inschakelen van de aangesloten power tool
- 2 motoren, kopergewikkeld en met thermische veiligheid, made in EU
- Grote 62 liter tank met kipsysteem voor eenvoudig legen van de tank
- Stalen onderstel met metalen PU-beklede wielen, en handvat
- Dichtingen zijn bestand tegen oliën
- Nanotech "SANI" filter tegen bacteriën, schimmels en microparasieten
- Aluminium instelbare buizen met kunststof omwikkeld: licht en zeer stevig
- Flexibele slang met zeer hoge druk- en draaiweerstand
- Nylonklemmen op de tank bestand tegen verdraaiing en stoten
- Slimme kablehaak op de kop

Order nr.		717001270 €
Orig. nr.		WETCAT 262 IET
Spanning	V	230
Frequentie	Hz	50
Vermogen motor	kW	2,6
Aantal motoren		2
Aantal trappen		2
Koeling		bypass
Tankinhoud	l	62
Tankmateriaal		inox
Filteroppervlak	cm ²	3627
Lengte slang	m	4
Diameter slang	mm	38
Geluidsniveau	dB(A)	74,5
Stopcontacten maximum vermogen	W	1150
Luchtdebiet	l/min	6666
Onderdruk	mbar	247
Kabel lengte	m	8,5
Gewicht	kg	21,90
Afmetingen (l x b x h)	mm	570 x 700 x 1140
Prijs	€	449,00



Industriële stofzuiger voor droge toepassingen in bouw en houtbewerking.

Kenmerken:

- **Automatische filterreiniging**
- Stekkerdoos 230 V / 2300 W voor power tools, stofzuiger schakelt automatisch in bij inschakelen van de aangesloten power tool
- **2-traps motor** voor zwaar werk, kopergewikkeld en met thermische veiligheid
- Bestemd voor zwaar gebruik en lange levensduur
- Groot filteroppervlak garandeert hoge zuigprestaties
- Aluminium instelbare buizen met kunststof omwikkeld: licht en zeer stevig
- Flexibele slang met zeer hoge druk- en draaiweerstand
- Nylonklemmen op de tank bestand tegen verdraaiing en stoten
- Slimme kablehaak op de kop

Model 137 RSCM met filter van klasse M, voor een optimale luchtkwaliteit.

Order nr.		717002130 €	717002150 €
Orig. nr.		DRYCAT 137 RSC	DRYCAT 137 RSCM
Spanning	V	230	230
Frequentie	Hz	50	50
Vermogen motor	kW	1,3	1,3
Aantal motoren		1	1
Aantal trappen		2	2
Koeling		bypass	bypass
Tankinhoud	l	37	37
Tankmateriaal		kunststof	kunststof
Filteroppervlak	cm ²	5000	5000
Lengte slang	m	4	4
Diameter slang	mm	38	38
Geluidsniveau	dB(A)	72	72
Stopcontacten maximum vermogen	W	2300	2300
Luchtdebiet	l/min	3333	3333
Onderdruk	mbar	223	223
Kabel lengte	m	8,5	8,5
Gewicht	kg	14,30	15,00
Afmetingen (l x b x h)	mm	390 x 390 x 900	430 x 430 x 830
Prijs	€	409,00	519,00



Stogzuiger voor natte en droge toepassingen en voor gebruik met houtbewerkingsmachines.

Voordelen:

- Voorzien van een elektronisch stopcontact.
- **Automatische opstart van de stofzuiger** samen met aangesloten machine.
- Performant bypass systeem zorgt voor constante onderdruk en zuigkracht.
- Kan gebruikt worden zonder extra papierfilter

Geleverd met :

- slang
- schuimfilter
- nylonfilter
- Papier filterzakken apart beschikbaar, en vooral geschikt voor zware toepassingen.

Order nr.	845002010	
Orig. nr.	VC45PP	
Spanning	V	230
Vermogen motor	kW	1,4
Tankinhoud	l	45
Zuigkracht	mBar	215
Luchtverplaatsing	l/s	55
Stopcontacten maximum vermogen	W	2200
Debiet	m3/u	220
Gewicht	kg	8,80
Afmetingen (l x b x h)	mm	430 x 430 x 720
Prijs	€	304,00

Accessoires stof- & waterzuigers



Filterzak papier voor stofzuiger VC45PP.

Order nr.	845002011	
Orig. nr.	004.381	
Voor type	VC45PP	
Gewicht	kg	1,00
VE	5	
Min. bestelhoeveelheid	10	
Prijs/VE	€	3,50



Filter "M" voor stofzuiger VC45PP.

Order nr.	845002012	
Orig. nr.	004.437	
Voor type	VC45PP	
Gewicht	kg	1,00
Prijs	€	52,50



Set dubbele elleboog + vloerborstel Ø 40 mm voor stofzuiger VC45PP.

Order nr.	845002013	
Orig. nr.	VC45PP-SET	
Voor type	VC45PP	
Gewicht	kg	1,00
Prijs	€	38,50

Anti-vermoeidheidsmatten

Anti-vermoeidheidsmatten van Stanley

Voorkom voet-, knie- en rugproblemen dankzij de ergonomische antivermoeidheidsmatten van Stanley.

Vervaardigd uit hoogwaardig PU, voor een uitstekende steun & duurzaamheid.



Anti-vermoeidheidsmat

Voorkom voet-, knie- en rugproblemen dankzij de ergonomische antivermoeidheidsmatten van Stanley. Vervaardigd uit **hoogwaardig PU**, voor een uitstekende steun en duurzaamheid.

Kenmerken:

- Slijtvast
- Antislip
- Antistatisch
- Schuin aflopende randen voorkomt struikelen
- Antistatisch
- Isolerende werking tegen kou, warmte, trillingen en geluid
- Bestand tegen de meeste industriële en automotiv vloeistoffen en chemicaliën
- Scheurvast

Order nr.	751989052 €	751989053 €
Orig. nr.	AFM90	AFM150
Dikte	mm 15	15
Gewicht	kg 1,81	4,54
Afmetingen (l x b x h)	mm 610 x 910 x 15	910 x 1520 x 15
Prijs	€ 59,90	139,00

KNIEMAT



Anti-vermoeidheidsmat knie-model

Voorkom kniepijn dankzij de ergonomische kniemat van Stanley. Vervaardigd uit **hoogwaardig PU**, voor een uitstekende steun en duurzaamheid.

Kenmerken:

- Slijtvast
- Antislip
- Antistatisch
- Isolerende werking tegen kou, warmte, trillingen en geluid
- Bestand tegen de meeste industriële en automotiv vloeistoffen en chemicaliën
- Scheurvast

Order nr.	751989055 €	
Orig. nr.	AFM30	
Dikte	mm	19
Gewicht	kg	0,66
VE	1	
Min. bestelhoeveelheid	12	
Afmetingen (l x b x h)	mm	300 x 560 x 19
Prijs/VE	€	26,90

STANLEY



AFM60EE



AFM60E84



AFM60E30



AFM60EH

Anti-vermoeidheidsmat "extensions"

Voorkom voet-, knie- en rugproblemen dankzij de ergonomische antivermoeidheidsmatten van Stanley. Vervaardigd uit **hoogwaardig PU**, voor een uitstekende steun en duurzaamheid. **Assembleerbaar** dankzij de puzzelranden. Ideaal voor wandelpaden.

Kenmerken:

- slijtvast
- antislip
- schuin aflopende randen voorkomt struikelen
- antistatisch
- isolerende werking tegen kou, warmte, trillingen en geluid
- bestand tegen de meeste industriële en automotieve vloeistoffen en chemicaliën
- scheurvast

Order nr.	Orig. nr.	Type	Gewicht	Afmetingen (l x b x h)	Prijs
			kg	mm	€
751989057	AFM60EE	eindstuk	1,81	610 x 910 x 15	59,90
751989058	AFM60E84	tussenstuk lang	1,68	610 x 840 x 15	54,50
751989059	AFM60E30	tussenstuk kort	0,59	610 x 300 x 15	24,90
751989060	AFM60EH	hoek	1,22	610 x 610 x 15	49,90

STANLEY

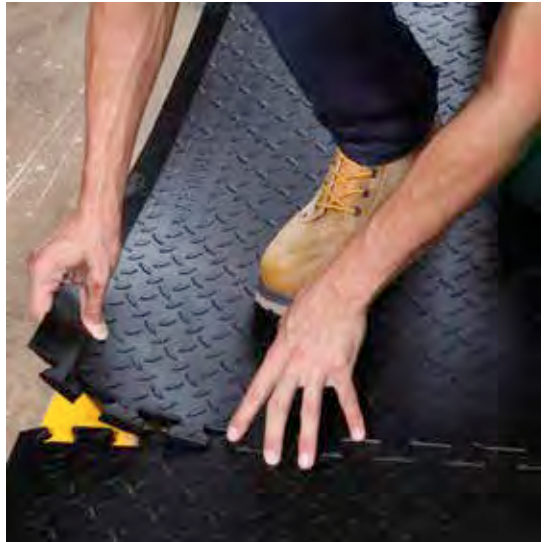

AFM60TC



AFM60TR



AFM60TH

Anti-vermoeidheidsmat "inter"

Voorkom voet-, knie- en rugproblemen dankzij de ergonomische antivermoeidheidsmatten van Stanley. Vervaardigd uit **hoogwaardig PU**, voor een uitstekende steun en duurzaamheid. **Assembleerbaar** dankzij de puzzelranden. Ideaal voor grotere oppervlakten.

Kenmerken:

- slijtvast
- antislip
- schuin aflopende randen voorkomt struikelen
- antistatisch
- isolerende werking tegen kou, warmte, trillingen en geluid
- bestand tegen de meeste industriële en automotieve vloeistoffen en chemicaliën
- scheurvast

Order nr.	Orig. nr.	Dikte	Type	Gewicht	VE	Afmetingen (l x b x h)	Prijs/VE
		mm		kg		mm	€
751989061	AFM60TC	15	center	1,63	1	610 x 610 x 15	44,50
751989062	AFM60TR	15	rand	1,41	2	610 x 610 x 15	88,50
751989063	AFM60TH	15	hoek	1,50	2	610 x 610 x 15	88,50

EQUIPMENT

Veiligheidsmarkering

TOOLS



Afscherming voor werkzaamheden of om te wijzen op gevaar en doorgang te verhinderen. Bestaat uit drie panelen die onderling verstelbaar zijn.

Order nr.	758136917 €
Orig. nr.	AFW1710
Afmetingen (l x b x h)	mm 1710 x 1000 x 0
Prijs	€ 135,00

TOOLS



Uitbreiding voor AFWU570.

Order nr.	758136918 €
Orig. nr.	AFWU570
Afmetingen (l x b x h)	mm 570 x 1000 x 0
Prijs	€ 45,90

TOOLS



Veiligheidsmarkering die voorbijgangers attent maakt op slipgevaar.

Order nr.	758136799 €
Orig. nr.	SI330
Afmetingen (l x b x h)	mm 330 x 680 x 0
Prijs	€ 18,50

Afscherming - Afbakening

TOOLS



Kunststof afsluitbareel die uitschuifbaar is tot 2 meter en die gemakkelijk verplaatsbaar is. De brede voeten garanderen een prima stabiliteit.

Order nr.	758136714 €
Orig. nr.	FH200
Prijs	€ 153,00

TOOLS



Uitbreiding voor FH200 die het makkelijk mogelijk maakt om grotere gebieden af te sluiten. Deze uitbreiding is eveneens uitschuifbaar tot 2 meter.

Order nr.	758136716 €
Orig. nr.	FHU200
Prijs	€ 123,00

TOOLS



Vierkant schaarhekken in metaal, eveneens uitschuifbaar tot maximaal 1.3 meter. Ideaal geschikt om gevaarlijke zones af te schermen.

Order nr.	758136575 €
Orig. nr.	SI130
Prijs	€ 117,00

TOOLS



Metalen afsluitbareel uitschuifbaar tot 2m (SI200) of tot 4m (SI400). Linker- en rechterkant van de bareel zijn voorzien van haak en ring voor het verbinden van meerdere barelen. Hoogte 1m. Er kunnen wielen met rem worden gemonteerd om het openen van en het verplaatsen van de bareel te vergemakkelijken. SI400 met extra voet in het midden voor een prima stabiliteit bij volledige benutting van de lengte.

Geleverd in 1 karton doos. Ongemonteerd.

Order nr.	745800450 €	745800460 €
Orig. nr.	SI200	SI400
Prijs	€ 85,50	201,00

TOOLS



Afzetlint uit polypropyleen, leverbaar in rood-wit of zwart-geel.

Order nr.	758136873	758136874	758136878
Orig. nr.	PW100MZG	PW100MRW	PWT500MRW
Type	zwart/geel	rood/wit	rood/wit
Breedte mm	50	50	80
Lengte m	100	100	500
Prijs €	5,70	5,70	25,50

TOOLS



Kleefbare signalisatielinten uit plastic met een hoogte van 50 mm en op een rol van 33 m. Ideaal geschikt om gevaar te markeren. Recycleerbaar.

Order nr.	758136868	758136869
Orig. nr.	KS533ZG	KS533RW
Type	zwart/geel	rood/wit
Breedte mm	50	50
Lengte m	33	33
Prijs €	11,90	11,90

TOOLS



Kleefbare signalisatielinten met antislip om uitglijden te vermijden. Gemaakt uit plastic met een hoogte van 50 mm en op een rol van 5 m. Recycleerbaar.

Order nr.	758136871	758136872
Orig. nr.	KS55Z	KS55ZG
Type	zwart	zwart/geel
Breedte mm	50	50
Lengte m	5	5
Prijs €	9,10	9,10

TOOLS



Verkeerskegel in PVC met licht reflecterende witte band. Oranje-wit. Plaatsbesparend stapelbaar. Voor gebruik binnen het bedrijf. Samendrukbaar.

Order nr.	745800610
Orig. nr.	SK30PV
Hoogte mm	300
Omschrijving	1 witte band
Materie	plooibaar PVC
Afmetingen (l x b x h) mm	225 x 225 x 300
Prijs €	8,20

TOOLS



Verkeerskegel in PE (hard) met witte band. Rood-wit. Plaatsbesparend stapelbaar. Voor gebruik binnen het bedrijf.

Order nr.	745800550	745800560
Orig. nr.	SK30PE	SK54PE
Hoogte mm	300	540
Omschrijving	1 witte band	2 witte banden
Materie	PE	PE
Afmetingen (l x b x h) mm	220 x 220 x 300	
Prijs €	6,00	11,90

TOOLS



Verkeerskegel in PVC met reflecterende band klasse 1. Oranje-wit. Plaatsbesparend stapelbaar. Voor openbaar gebruik. Samendrukbaar.

Order nr.	745800630	745800640
Orig. nr.	SK30PV1	SK49PV1
Hoogte mm	300	490
Omschrijving	2 witte banden, klasse 1	2 witte banden
Materie	plooibaar PVC	plooibaar PVC
Prijs €	10,00	15,50



Afzetpaal in kunststof diam. 30mm. Met achtkant basis. Hoogte 90cm. Totaal gewicht 675 gr. Afmeting basis 275x275mm x 85mm H. Verpakt in karton per 12 stuks.

Order nr.	754800102 €	
Orig. nr.	SPP1RB	
Hoogte	mm	900
Kleur	rood/wit	
Prijs	€	17,50



VERZWAARDE VOET



Afzetpaal in ABS, diameter 50mm, hoogte 950mm. Basis 0,35kg, kan gevuld worden met 2.5L water. Kettingen kunnen bevestigd worden aan de ring bovenaan. Verkrijgbaar in zwart/geel of wit/rood.

Order nr.	754800103 €	754800104 €
Orig. nr.	SPP2RB	SPP2NJ
Diameter	mm	5
Hoogte	mm	95
Kleur	rood/wit	zwart/geel
Prijs	€	22,90



Stalen afzetpaal met voet, diameter 50mm, hoogte 1000mm. Diameter basis: 360mm. Voorzien van gaten voor ketting KBR825 of latten SAP1BAR. Gewicht 7,25kg.

Order nr.	758136596 €	758136597 €
Orig. nr.	SPPS1ZG	SPPS1WR
Diameter	mm	50
Hoogte	mm	1000
Kleur	zwart/geel	wit/rood
Prijs	€	61,50



Afzetpaal in kunststof met een verzwaaarde voet van 3.8 kg en in rood/wit uitvoering. Perfect combineerbaar met de ketting KWR250. Dit is een plastic ketting, eveneens in rood/wit uitvoering, met een lengte van 25 meter en een diameter van 8 mm.

Order nr.	758136781 €	
Orig. nr.	APK95WR	
Type	wit/rood	
Lengte	m	950
Omschrijving	afzetpaal in kunststof met voet	
Prijs	€	46,50



Kunststof latten rood/wit voor metalen afzetpaal SPPS1WR. Lengte 1,2m.

Order nr.	758136598 €	
Orig. nr.	SAP1BAR	
Afmetingen (l x b x h)	mm	1200 x 100 x 20
Prijs	€	44,50



Plastiek ketting. Rood-wit. Wasbaar, niet geleidend, anti-magnetisch en licht. Temperatuur bestendig tussen -10°C en 75°C. Diameter schakel 8mm. Afmeting schakel 29x49mm. Lengte ketting: 25m. Individueel verpakt in een transparante lichtplastic zak.

Order nr.	754800150 €	
Orig. nr.	KBR825	
Diameter	mm	8
Lengte	m	25
Kleur	rood/wit	
Prijs	€	51,50



Set van 4 verbindingsringen voor ketting (2xR+2xW).

Order nr.	745800240 €	
Orig. nr.	SR802	
Dikte	mm	6
Prijs	€	8,90

TOOLS



Presentatie-opzetstuk voor afzetpaal. Past op SPP1, SPP2, SPPS afzetpalen. Formaat A4.

Order nr.	745800662 €
Orig. nr.	SRP1
Prijs	€ 54,50

TOOLS



Afzetpaal met ronde voet en uittrekbare band van 2 meter. Band verkrijgbaar in rood/wit uitvoering of met verbodstekken.

Order nr.	758136950 €	758136952 €
Orig. nr.	AU2WR	AU2VE
Type	wit/rood	verbod
lengte mm	2000	2000
Omschrijving	afzetpaal met uittrekbare band	afzetpaal met uittrekbare band
Prijs	€ 188,00	188,00

TOOLS



Afzetpaal met ronde voet en uittrekbare band van 2 meter. Band verkrijgbaar in geel/zwart uitvoering of uitvoering in gevaarstekken.

Order nr.	758136944 €	758136946 €
Orig. nr.	AU2GZ	AU2GE
Type	geel/zwart	gevaar
lengte m	2	2
Prijs	€ 188,00	188,00

TOOLS



Bevestigingskit en zelfklevende reflecterende tape voor PPL80.

Order nr.	745800665 €	745800666 €
Orig. nr.	PPLFIX	PPLTAPE
Type	bevestigingskit	reflecterende tape
Prijs	€ 2,70	3,50

TOOLS

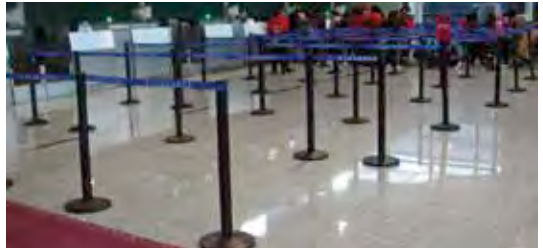

Afzetpaal met ronde voet en uittrekbare band van 2 meter. Afzetpaal verkrijgbaar in zwarte uitvoering met zwarte band of in verchroomde uitvoering met grijze of zwarte band.

Order nr.	758136986 €	758136987 €	758136988 €
Orig. nr.	AU2BB	AU2CG	AU2CB
Type	zwart/zwart	chromé/grijs	chromé/zwart
lengte mm	2000	2000	2000
Kleur			zwart
Prijs	€ 188,00	188,00	188,00

TOOLS



Afzetbanden met wandbevestiging, verkrijgbaar in verschillende uitvoeringen (rood/wit, zwart/geel, verboden doorgang, gevaar) met een lengte van ofwel 2 meter of een lengte van 4 meter.

Order nr.	Orig. nr.	Type	Lengte mm	Prijs €
758136958 €	AW2WR	wit/rood	2000	117,00
758136959 €	AW2GZ	zwart/geel	2000	117,00
758136961 €	AW2GE	gevaar	2000	117,00
758136962 €	AW2VE	verbod	2000	117,00
758136965 €	AW4WR	wit/rood	4000	204,00
758136966 €	AW4GZ	zwart/geel	4000	204,00
758136968 €	AW4GE	gevaar	4000	215,00
758136969 €	AW4VE	verbod	4000	215,00

TOOLS

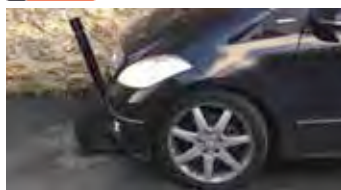

Flexibele verkeerszuil diam 100mm, hoogte 800mm. PU. Wordt niet beschadigd en brengt geen schade aan voertuigen wanneer die erover rijden.

Order nr.	745800663	745800664
Orig. nr.	PPL80ZG	PPL80Z
Hardheid	A98	A98
Treksterkte	MPa 34	34
Rek tot breuk	% 350	350
Trekspanning bij 300% rek	MPa 23	23
Trekrek op DE100%	MPa	
Scheursterkte	KN/m 84	84
Kleur	zwart-geel	zwart
Gebruikstemperatuur	°C -20 - +70	-20 - +70
Prijs	€ 161,00	161,00

TOOLS



Bevestigingskit en zelfklevende reflecterende tape voor PPL80.

Order nr.	745800665	745800666
Orig. nr.	PPLFIX	PPLTAPE
Type	bevestigingskit	reflecterende tape
Prijs	€ 2,70	3,50

TOOLS



Veiligheidsbeugels voor gebruik in gevarenszones in werkplaatsen als beveiliging of als afscheiding van verschillende zones. Ook buiten te gebruiken als afzetbeugel. Gele uitvoering met zwarte banden.. Voorzien van kniebuis ter versterking. Voet 150x150mm. BHK601500 in verzinkte uitvoering.

Order nr.	Orig. nr.	Diameter mm	Aantal banden	Afmetingen (l x b x h) mm	Prijs €
745800701	BHK401000	40	6	1000 x 40 x 1000	92,50
745800702	BHK401500	40	6	1500 x 40 x 1000	101,00
745800703	BHK402000	40	6	2000 x 40 x 1000	122,00
745800704	BHK601000	60	6	1000 x 60 x 1000	110,00
745800705	BHK601500	60	0	1500 x 60 x 1000	135,00
745800706	BHK602000	60	6	2000 x 60 x 1000	156,00

TOOLS



HEAVY DUTY



Extra zware veiligheidsbeugels voor gebruik in gevarenszones in werkplaatsen als beveiliging of als afscheiding van verschillende zones. Ook buiten te gebruiken als afzetbeugel. Gele uitvoering met zwarte banden (3M). Diameter 76mm, dikte 3mm. Voet 160x140x10mm.

BHK76: zonder plaat
BHK76P met versterkingsplaat 4mm dik

Order nr.	Orig. nr.	Diameter mm	Afmetingen (l x b x h) mm	Prijs €
745800707	BHK763835	76	375 x 76 x 350	134,00
745800708	BHK767535	76	750 x 76 x 350	149,00
745800709	BHK7610035	76	1000 x 76 x 350	165,00
745800710	BHK767560	76	750 x 76 x 600	179,00
745800711	BHK7610060	76	1000 x 76 x 600	190,00
745800712	BHK7675120	76	750 x 76 x 1200	224,00
745800713	BHK76100120	76	1000 x 76 x 1200	230,00
745800714	BHK76P7535	76	750 x 76 x 350	219,00
745800715	BHK76P10035	76	1000 x 76 x 350	239,00
745800716	BHK76P7560	76	750 x 76 x 600	311,00
745800717	BHK76P10060	76	1000 x 76 x 600	366,00

TOOLS



Beschermepaal voor gebruik in gevarenszones in werkplaatsen als beveiliging of als afscheiding van verschillende zones. Extra zware uitvoering. Gele uitvoering met zwarte banden (3M).

Order nr.	745800721	745800722	745800723
Orig. nr.	BHKP090	BHKP159	BHKP273
Type	paal	paal	paal
Diameter	mm 90	159	273
Aantal banden	2	2	2
Afmetingen voet (b x d)	mm 200x200x10	250x250x15	400x400x20
Afmetingen (l x b x h)	mm 200 x 200 x 1200	250 x 250 x 1200	400 x 400 x 1200
Prijs	€ 204,00	384,00	749,00

TOOLS

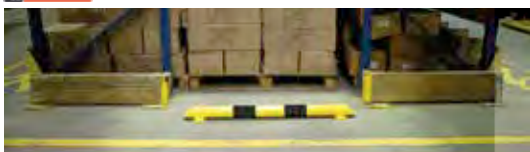

Parkeerstop voor gebruik in gevarenczones in werkplaatsen als beveiliging of als afscheiding van verschillende zones. Extra zware uitvoering. Gele uitvoering met zwarte banden (3M).

Order nr.	745800724	745800725	745800726
Orig. nr.	BHKS40	BHKS80	BHKS120
Type	stop	stop	stop
Diameter mm	76	76	76
Aantal banden	1	2	2
Afmetingen voet (b x d) mm	130x70x10	130x70x10	130x70x10
Afmetingen (l x b x h) mm	400 x 130 x 86	800 x 130 x 86	1200 x 130 x 86
Prijs	€ 80,50	€ 90,50	€ 113,00

TOOLS



Beschermhoek voor gebruik in gevarenczones in werkplaatsen als beveiliging of als afscheiding van verschillende zones. Extra zware uitvoering. Gele uitvoering met zwarte banden (3M).

Order nr.	745800718	745800719	745800720
Orig. nr.	BHKH35	BHKH60	BHKH120
Type	hoek	hoek	hoek
Diameter mm	76	76	76
Aantal banden	5	5	5
Afmetingen voet (b x d) mm	160x140x10	160x140x10	160x140x10
Afmetingen (l x b x h) mm	600 x 600 x 350	600 x 600 x 600	600 x 600 x 1200
Prijs	€ 286,00	€ 345,00	€ 442,00





Flexibele stootband recht

- Eenvoudig aan te brengen door zelfklevende tape.
- gemaakt uit flexibel nitrilrubber
- Resistent tegen oliën, vetten, koolwaterstoffen en verdunde zuren.
- Zwart/geel.
- Verkrijgbaar in lengte 75cm of 5m

Order nr.	758137004	758137005
Orig. nr.	VMSR67	VMSR650
Breedte	mm 60	mm 60
Lengte	mm 750	5000
Kleur	zwart/geel	zwart/geel
Prijs	€ 11,90	77,90



Flexibele stootband hoek

- Eenvoudig aan te brengen door zelfklevende tape.
- gemaakt uit flexibel nitrilrubber
- Resistent tegen oliën, vetten, koolwaterstoffen en verdunde zuren.
- Zwart/geel.
- Verkrijgbaar in lengte 75cm of 5m

Order nr.	758137001	758137002
Orig. nr.	VMSH37	VMSH350
Prijs	€ 10,90	66,50



Stootbescherming recht.

- Voor I-profielen
- Eenvoudig aan te brengen door zelfklevende randen.
- gemaakt uit EVA-schuim
- Resistent tegen solventen en olieproducten.
- Zwart/geel.
- Verkrijgbaar in diameter 40 en 100 mm.

Order nr.	758136997	758136998	758136999
Orig. nr.	VMR4	VMR10	VMR15
Diameter	mm 40	100	100
Kleur	geel/zwart	geel/zwart	geel/zwart
L	mm 750	1000	1000
C	mm 20x8	50x8	75x15
Prijs	€ 16,50	66,50	88,50

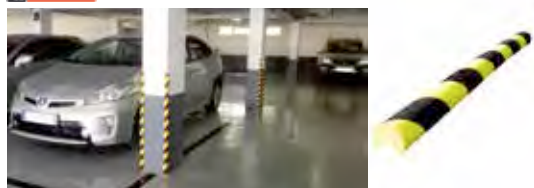

Stootbescherming hoek.

- Eenvoudig aan te brengen door zelfklevende randen
- gemaakt uit EVA schuim
- Resistent tegen solventen en olieproducten
- Zwart/geel
- Verkrijgbaar in diameter 40, 100 en 150 mm

Order nr.	758136994	758136995	758136996
Orig. nr.	VMH4	VMH10	VMH15
Diameter	mm 40	100	150
Kleur	geel/zwart	zwart/geel	zwart/geel
L	mm 750	1000	1000
C	mm 25	50	75
Prijs	€ 16,50	66,50	88,50

TOOLS



Bumper bescherming.

- Eenvoudig aan te brengen door zelfklevende strip
- gemaakt uit schuimrubber voor betere shockabsorptie
- Resistent tegen solventen en olieproducten.
- Zwart/geel.

Order nr.	758137000 €	
Orig. nr.	VMB8	
Breedte	mm	80
Lengte	mm	1000
Kleur	zwart/geel	
Prijs	€	49,90

TOOLS



Schokdemper schuimrubber

- Eenvoudig aan te brengen door zelfklevende rand.
- Resistent tegen solventen en olieproducten.
- Zwart/geel.

Order nr.	758137006 €	758137007 €
Orig. nr.	VMM030	VMM150
Breedte	mm	1000
Lengte	m	1.5
Kleur	zwart/geel	zwart/geel
Prijs	€	77,90

TOOLS



Profielbescherming hoek

- Eenvoudig aan te brengen door zelfklevende rand.
- gemaakt uit nitrilrubber
- Resistent tegen oliën, vetten, koolwaterstoffen en verdunde zuren.
- Zwart/geel

Order nr.	758137003 €	
Orig. nr.	VMH7	
Breedte	mm	30
Lengte	mm	700
Kleur	zwart/geel	
Prijs	€	3,50

TOOLS



Parkeerbeugel in metalen uitvoering met hangslot. Ideaal geschikt voor het vrijhouden van parkeerplaatsen.

Order nr.	758136909 €	
Orig. nr.	PBC38	
Omschrijving	met hangslot	
Diameter	mm	38
Afmetingen (l x b x h)	mm	735 x 375 x 0
Prijs	€	64,90

TOOLS



Parkeerbeugel in metalen uitvoering met cylinderslot. geschikt voor het vrijhouden van parkeerplaatsen. Geleverd met 3 sleutels. Verschillende sleutel/slot voor elke parkeerbeugel. Parkeerbeugel met identieke sloten mogelijk op aanvraag.

Order nr.	758136906 €	758136907 €
Orig. nr.	PBB54	PBB100
Omschrijving	met cylinderslot	Met driehoekig slot
Diameter	mm	54
Afmetingen (l x b x h)	mm	860 x 465 x 0
Prijs	€	129,00

EQUIPMENT

Omgevingspiegels

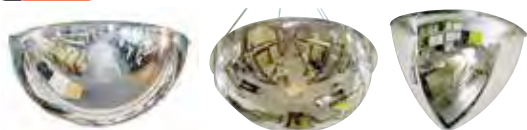

Veiligheidsspiegel met een diameter van 65 mm. Ter beveiliging van uw burelen of winkelruimten. Onbreekbaar. Inclusief bevestiging. De SPS90 bedekt een hoek van 90°, de SPS180 een hoek van 180° en de SPS360 een hoek van 360°.

Order nr.	758136756	758136754	758136755
Orig. nr.	SPS90	SPS180	SPS360
Materiaal	polycarbonate	polycarbonate	polycarbonate
Diameter mm	650	650	650
Hoek °	90	180	360
Gebruikerafstand m	0-6		
Prijs €	68,50	123,00	172,00



Veiligheidsspiegel. Ter beveiliging van uw burelen en winkel. Voor binnens of buiten met glazen spiegel van 330mm. Niet verstelbaar onder hoek.

Order nr.	745800540
Orig. nr.	SSP330
Materiaal	glas
Diameter mm	330
Gebruikerafstand m	0-8
Prijs €	46,50



Veiligheidsspiegel voor binnen- en buitengebruik. Ter beveiliging van uw parking, winkel, magazijn, ... Spiegel van 600 mm in polycarbonaat. Geleverd met bevestigingskit.

Order nr.	745800520
Orig. nr.	SSP600
Materiaal	polycarbonaat
Diameter mm	600
distance d'utilisateur m	0-15
Prijs €	158,00



Veiligheidsspiegel. Ter beveiliging van uw winkel en parking. Voor buitengebruik met glazen spiegel en afmetingen 490x790mm. Onder hoek verstelbaar.

Order nr.	758136729
Orig. nr.	SSP177RW
Materiaal	polycarbonate
Gebruikerafstand m	0-20
Afmetingen (l x b x h) mm	490 x 790 x 0
Prijs €	285,00



Veiligheidsspiegel met reflecterende band.

Ronde veiligheidsspiegel voor buitengebruik. Uit onbreekbaar polycarbonaat. Met reflecterende rood/witte band. Geleverd met bevestigingskit.

Order nr.	Orig. nr.	Materiaal	Diameter mm	Gebruikerafstand m	Prijs €
758136989	SSP45RW	polycarbonate	450	0-10	135,00
758136990	SSP60RW	polycarbonate	600	0-15	199,00
758136991	SSP80RW	polycarbonate	800	0-25	334,00



Rechthoekige veiligheidsspiegel voor buitengebruik.

Kenmerken:

- Uit onbreekbaar polycarbonaat.
- Met reflecterende rood/witte band.

Geleverd met bevestiging.

Order nr.	758136992	758136993
Orig. nr.	SSP354RW	SSP558RW
Materiaal	polycarbonate	polycarbonate
distance d'utilisateur m	0-10	0-20
Afmetingen (l x b x h) mm	540 x 350 x 30	865 x 545 x 30
Prijs €	198,00	438,00

Kabelbruggen



Soepele kabelbrug in kunststof voor kabels met een maximale diameter van 12 mm. Verkrijgbaar per 3 meter (BKB300) of per 5 meter (BKB500). Ideaal geschikt om te gebruiken in uw kantoor.

Order nr.	758136973	758136974
Orig. nr.	BKB300	BKB500
Maximum diameter kabel-doorlaat	mm 12	12
Lengte	m 3	5
Prijs	€ 29,50	47,50



Soepele kabelbrug in kunststof voor kabels met een maximale diameter van 15 mm. Verkrijgbaar per 3 meter (BKB300A) of per 5 meter (BKB500A). Ideaal geschikt om te gebruiken in uw kantoor.

Order nr.	758136975	758136976
Orig. nr.	BKB300A	BKB500A
Maximum diameter kabel-doorlaat	mm 15	15
Lengte	m 3	5
Prijs	€ 48,50	79,50



Rigide kabelbrug in kunststof met twee doorgangen voor kabels met een maximale diameter van 10 mm. Enkel verkrijgbaar per 2 meter. Ideaal geschikt om te gebruiken in uw kantoor.

Order nr.	758136977
Orig. nr.	RKB200
Maximum diameter kabel-doorlaat	mm 10
Lengte	m 2
Prijs	€ 38,90



Enkele hulpstukken bij de RKB200 om de kabels gemakkelijk doorgang te laten vinden in uw kantoor op een ordelijke manier.

Order nr.	758136978	758136979	758136980
Orig. nr.	RKB200H	RKB200T	RKB200C
Omschrijving	hoek	T-vorm	verbindingstuk
Prijs	€ 5,70	5,70	5,70



Slang- en kabelbrug voor 1 of meer kabels met max. diameter 20mm (SI1020), 40mm (SI0440) of 60mm (SI0260). Geschikt voor de bescherming van slangen en kabels bij wegovergangen. Ook voor vrachtwagen- en kraanverkeer. Olie- en vetbestendig. Vervaardigd in rubber en zodoende elektrisch isolerend. De kabels of slangen worden van boven ingebracht. De brug kan gewoon op de grond worden gelegd of kan ook aan de grond gekleefd worden. Zeer flexibele rubber. Kan zeer compact worden opgeborgen. Geleverd in rol. SI0260 is voorzien van gele reflecterende strips om de visibiliteit te verhogen.

Order nr.	745800010	745800020	745800025
Orig. nr.	SI1020	SI0440	SI0260
Maximum diameter kabel-doorlaat	mm 20	40	60
Lengte	m 10	4	2
Afmetingen (l x b x h)	mm 10000 x 100 x 30	4000 x 170 x 50	2000 x 240 x 72
Prijs	€ 226,00	226,00	161,00



Stevige kabelbrug in rubber. Lengte per module 50cm.

Order nr.	758136970	758136971	758136972
Orig. nr.	KB500	KB800	KB1200
Maximum diameter kabel-doorlaat	mm 2x50	2x80	120
Lengte	m 0,5	0,6	0,8
Capaciteit	t 40	40	40
Prijs	€ 103,00	149,00	290,00

EQUIPMENT

TOOLS



Kabelbrug in kunststof, geschikt voor twee kabels met telkens een diameter van maximaal 35 mm. De kabels worden langs boven ingebracht. De TKB240 is ideaal geschikt voor duurzaam gebruik, laat de doorgang van auto's gemakkelijk toe en heeft een licht remmend effect. Bevestigbaar op zowel beton als op asfalt.

Order nr.	758136639 €	
Orig. nr.	TKB240	
Type	zwart/geel	
Maximum diameter kabel- doorlaat	mm	35
Aantal	2	
Afmetingen (l x b x h)	mm	500 x 500 x 60
Prijs	€	100,00

TOOLS



Accessoires. De TKB240H sluit perfect aan op de TKB240 en is ideaal geschikt om een hoek van 45° te vormen. De kabelbrug kan langs beide uiteinden afgesloten worden met de TKB240S.

Order nr.	758136651 €	758136657 €
Orig. nr.	TKB240S	TKB240H
Afmetingen (l x b x h)	mm 200 x 500 x 60	250 x 50 x 60
Prijs	€ 49,90	72,90

TOOLS



Kabelbrug in kunststof, geschikt voor vier kabels met telkens een diameter van ongeveer 40 mm. De kabels worden langs boven ingebracht. De RKB440 is ideaal geschikt voor duurzaam gebruik, laat de doorgang van auto's gemakkelijk toe en heeft een licht remmend effect. Bevestigbaar op zowel beton als op asfalt.

Order nr.	758136640 €	
Orig. nr.	RKB440	
Maximum diameter kabel- doorlaat	mm	4 x 35
Afmetingen (l x b x h)	mm	500 x 400 x 70
Prijs	€	94,90

TOOLS



Accessoires. De RKB440H sluit perfect aan op de RKB440 en is ideaal geschikt om een hoek van 90° te vormen. De kabelbrug kan langs beide uiteinden afgesloten worden met de RKB440S.

Order nr.	758136652 €	758136658 €
Orig. nr.	RKB440S	RKB440H
Omschrijving	eindstuk	hoek 90°
Afmetingen (l x b x h)	mm 200 x 500 x 70	250 x 50 x 70
Prijs	€ 42,90	111,00

TOOLS



Kabelbrug in kunststof, geschikt voor vijf kabels met telkens een diameter van maximaal 35 mm. De kabels worden ook hier langs boven ingebracht. Doordat de RKB535 gemakkelijk te installeren valt, is deze ideaal geschikt voor tijdelijk gebruik zoals bijvoorbeeld op beurzen. Wegens het tijdelijke karakter van deze kabelbrug is deze enkel bevestigbaar met lijm. Belasting tot 40 ton mogelijk.

Order nr.	758136637 €	
Orig. nr.	RKB535	
Maximum diameter kabel- doorlaat	mm	35
Aantal	5	
Afmetingen (l x b x h)	mm	790 x 440 x 50
Prijs	€	137,00

TOOLS



De RKB535H sluit perfect aan op de RKB535 en is ideaal geschikt om een hoek van 30° te vormen.

Order nr.	758136656 €	
Orig. nr.	RKB535S	
Maximum diameter kabel- doorlaat	mm	35
Aantal	5	
Omschrijving	hoek 30°	
Afmetingen (l x b x h)	mm	380 x 440 x 50
Prijs	€	49,90

Oprijdrempels

TOOLS

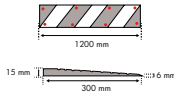

Toegangsdrempel in puur rubber, klein hoogteverschil van 6 mm tot 15 mm. Ideaal geschikt om poortdoorgangen te accentueren (geel-zwarte uitvoering).

Order nr.	758136926 €
Orig. nr.	TD1200
Afmetingen (l x b x h)	mm 1200 x 300 x 150
Prijs	€ 63,90

TOOLS



Oprijdrempel in puur rubber. Ideaal geschikt om een hoogteverschil te overwinnen. Geel-zwarte uitvoering met dubbele kabeldoorvoer. Kan worden afgeboord aan de beide uiteinden met rond eindstuk. Aan de grond bevestigbaar met ofwel spijkers, pluggen of polyurethane lijm (zie accessoires).

Order nr.	758136856 €	758136859 €	758136861 €
Orig. nr.	OD100	OD150	OD200
Maximum diameter kabeldoorlaat	mm 25-30	30-35	35-40
Afmetingen (l x b x h)	mm 600 x 300 x 100	600 x 360 x 150	600 x 450 x 200
Prijs	€ 86,50	124,00	185,00

TOOLS



Eindstuk voor OD100-OD150-OD200.

Order nr.	758136863 €	758136864 €	758136865 €
Orig. nr.	HOD100	HOD150	HOD200
Voor type	OD100	OD150	OD200
Afmetingen (l x b x h)	mm 300 x 300 x 100	360 x 360 x 150	450 x 450 x 200
Prijs	€ 40,50	62,90	97,50

TOOLS



Accessoires voor OD.

Order nr.	758136867 €	758136866 €
Orig. nr.	ODFIXA	ODFIXB
Omschrijving	set met spijkers geschikt voor bevestiging in asfalt	set met pluggen geschikt voor bevestiging in beton
Prijs	€ 13,50	15,50

Verkeersdrempels

TOOLS



Verkeersdrempel in gerecycleerd rubber. Maximale belasting 20T met snelheidsremmend effect van maximaal 30 km/h. 1 kabeldoorvoer met een diameter van 27 mm. Verkrijgbaar in geel-zwarte uitvoering. Kan worden afgeboord aan de beide uiteinden met rond eindstuk. Aan de grond bevestigbaar met ofwel spijkers, pluggen of polyurethane lijm (zie accessoires). Drempel heeft een lengte van 250 mm, uitbreiding tot gewenste lengte mogelijk.

Dit artikel bestaat uit een geel stuk en een zwart stuk van telkens 250mm, en is in totaal 500mm lang.

Order nr.	758136895 €
Orig. nr.	VKS50250ZG
Afmetingen (l x b x h)	mm 350 x 250 x 50
Prijs	€ 63,90

TOOLS



Eindstuk voor verkeersdrempel.

Order nr.	758136898 €
Orig. nr.	VKS50250ZG
Voor type	VKS50250ZG
Afmetingen (l x b x h)	mm 350 x 200 x 50
Prijs	€ 41,50

EQUIPMENT

BESTSELLER

TOOLS



Verkeersdrempel in gerecycleerd rubber. Maximale belasting 20T met snelheidsremmend effect van maximaal 15 km/h. 1 kabeldoorvoer met een diameter van 27 mm. Verkrijgbaar in geel-zwarte uitvoering. Kan worden afgeboord aan de beide uiteinden met rond eindstuk. Aan de grond bevestigbaar met ofwel spijkers, pluggen of polyerethane lijm (zie accessoires). Elk stuk heeft een lengte van 250 mm, uitbreiding tot gewenste lengte mogelijk.

Dit artikel bestaat uit een geel stuk en een zwart stuk van telkens 250mm, en is in totaal 500mm lang.

Order nr.	758136896 €
Orig. nr.	VK70250ZG
Voor type	VK60100ZG
Afmetingen (l x b x h)	mm 500 x 220 x 70
Prijs	€ 74,90

TOOLS



Eindstuk voor verkeersdrempel.

Order nr.	758136899 €
Orig. nr.	VKS70250ZG
Voor type	VK70250ZG
Prijs	€ 55,50

TOOLS

40T



Verkeersdrempel in puur rubber. Maximale belasting 40T met snelheidsremmend effect van maximaal 15 tot 30 km/h. 1 kabeldoorvoer met een diameter van 27 mm. Kan worden afgeboord aan de beide uiteinden met rond eindstuk. Aan de grond bevestigbaar met ofwel spijkers, pluggen of polyerethane lijm (zie accessoires). Drempel heeft een lengte van 500mm. , uitbreiding tot gewenste lengte mogelijk.

Order nr.	758136709 €
Orig. nr.	VK60100ZG
Voor type	VK55183ZG
Afmetingen (l x b x h)	mm 500 x 430 x 60
Prijs	€ 131,00

TOOLS



Eindstuk voor verkeersdrempel.

Order nr.	758136710 €
Orig. nr.	VKS60100ZG
Voor type	VK60100ZG
Afmetingen (l x b x h)	mm 250 x 430 x 60
Prijs	€ 50,90

TOOLS



Verkeersdrempel in gerecycleerd rubber. Maximale belasting 20T met snelheidsremmend effect van maximaal 30 km/h. Dubbele kabeldoorvoer met telkens een diameter van 30 mm. Kan worden afgeboord aan de beide uiteinden met rond eindstuk. Aan de grond bevestigbaar met ofwel spijkers, pluggen of polyerethane lijm (zie accessoires). Drempel heeft een lengte van 1830 mm. Spijkers bijgeleverd.

Order nr.	758136891 €
Orig. nr.	VK55183ZG
Voor type	VK55183ZG
Afmetingen (l x b x h)	mm 1830 x 300 x 55
Prijs	€ 159,00

TOOLS



Eindstuk voor verkeersdrempel.

Order nr.	758136893 €
Orig. nr.	VKS55183ZG
Voor type	VK55183ZG
Afmetingen (l x b x h)	mm 180 x 300 x 55
Prijs	€ 26,90

TOOLS



PREMIUM



Verkeersdrempel in puur rubber. Maximale belasting 40T met snelheidsremmend effect van maximaal 15 km/h. Dubbele kabeldoorvoer met telkens een diameter van 30 mm. Kan worden afgeboord aan de beide uiteinden met rond eindstuk. Aan de grond bevestigbaar met ofwel spijkers, pluggen of polyerethane lijm (zie accessoires). Drempel heeft een lengte van 1830 mm. Spijkers bijgeleverd.

Order nr.	758136692 €
Orig. nr.	VK751830RW
Afmetingen (l x b x h)	mm 1830 x 300 x 75
Prijs	€ 329,00

TOOLS



Eindstuk voor verkeersdrempel.

Order nr.	758136696 €
Orig. nr.	VK75183R
Voor type	VK751830RW
Afmetingen (l x b x h)	mm 250 x 300 x 75
Prijs	€ 59,50

TOOLS



Verkeersdrempel in puur rubber. Maximale belasting 10T met snelheidsremmend effect van maximaal 5 tot 10 km/h. Geen kabeldoorvoer mogelijk. Kan worden afgeboord aan de beide uiteinden met rond eindstuk. Aan de grond bevestigbaar met ofwel spijkers, pluggen of polyerethane lijm (zie accessoires). Drempel heeft een lengte van 500 mm, uitbreiding tot gewenste lengte mogelijk. Ideaal geschikt om de snelheid in de werkplaats te beperken.

Order nr.	758136880 €
Orig. nr.	VK2025ZG
Afmetingen (l x b x h)	mm 600 x 500 x 20
Prijs	€ 68,50

TOOLS



Eindstuk voor verkeersdrempel.

Order nr.	758136883 €
Orig. nr.	VKS2025GR
Voor type	VK2025ZG
Afmetingen (l x b x h)	mm 600 x 300 x 20
Prijs	€ 49,50

TOOLS



Accessoires bij verkeersdrempels en kabelbruggen.

Order nr.	758136901 €	758136718 €	758136897 €
Orig. nr.	VKFIX300	VKFIX120	VKFIX4H
Omschrijving	spijkers geschikt voor bevestiging in asfalt	pluggen geschikt voor bevestiging in beton	H-vormige verbindingsonderdelen ter bevordering van onderlinge stevigheid
Aantal stuks	4	4	4
Capaciteit	300mm	120mm	-
Prijs	€ 4,30	18,90	8,80

TOOLS



Lijm geschikt voor bevestiging op alle ondergronden voor bevestiging van verkeersdrempels en kabelbruggen.

Order nr.	758136855 €
Orig. nr.	VKCOLPU
Omschrijving	lijm geschikt voor bevestiging op alle ondergronden
Aantal stuks	1
Capaciteit	290ml
Prijs	€ 34,90

EQUIPMENT

Absorptiematerialen

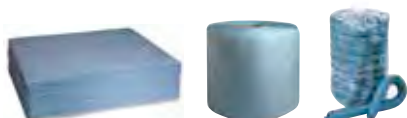

Absorptiematerialen voor olieklekken, ontworpen voor dagelijks gebruik op de werkvloer. Absorbeert alle oliën en koolwaterstoffen, ideaal geschikt voor het 'snel opruimen' van een lek, vooral bij machines of wagenparken. Stoot eveneens water af.

Order nr.	Orig. nr.	Samenstelling	Gewicht	Afmetingen (l x b x h)	Prijs
			kg	mm	€
724576491	D100	100 doeken	6,00	400 x 500 x 1	150,00
724576492	D200	200 doeken	7,20	400 x 500 x 1	150,00
724576493	R1	1 rol	10,00	40000 x 800 x 1	275,00
724576494	R2	2 rollen	10,00	40000 x 400 x 1	274,00
724576495	SLO12	12 slangen	8,00	1200 x 75 x 75	144,00
724576496	SLO4	4 slangen	4,00	3000 x 130 x 130	184,00
724576497	KG16	16 kussens groot	8,00	420 x 420 x 40	164,00



Interventiekits met absorptiemiddelen en persoonlijke beschermiddelen, stellen u in staat om snel te reageren op elk incident.

Transparante tas met 20 doeken en twee slangen van 1.2 meter. 1 paar handschoenen en 1 afvalzak met dichtingstrip.

Order nr.	724576500		€
Orig. nr.		IKO	
Gewicht	kg	15,00	
Prijs	€	83,90	

Opvangbakken



Opvang voor bidons van 25 liter. Uit rotatiegegoten geel PE. Uiterst corrosieresistent. Geschikt voor olieën, chemicaliën en zuren. Plastic bovenplaat zodat de bidon niet in de vloeistof komt te staan. Capaciteit conform de Vlaamse (Vlarem), Waalse en Nederlandse (CPR) milieuriichtlijnen.

Order nr.	724576519		€
Orig. nr.		OVB25	
Capaciteit	l	1x25	
Gewicht	kg	5,00	
Afmetingen (l x b x h)	mm	550 x 550 x 110	
Prijs	€	150,00	



Opvang voor bidons van 25 liter. Uit rotatiegegoten geel PE. Uiterst corrosieresistent. Plastic bovenplaat zodat de bidon niet in de vloeistof komt te staan. Capaciteit conform de Vlaamse (Vlarem), Waalse en Nederlandse (CPR) milieuriichtlijnen.

Order nr.	724576050	€	724576521	€
Orig. nr.	OVB50		OVB100	
Capaciteit	l	2x25	4x25	
Gewicht	kg	5,50	15,00	
Afmetingen (l x b x h)	mm	715 x 460 x 110	920 x 720 x 175	
Prijs	€	144,00	277,00	

TOOLS



Opvangwerkvloer voor 2 vaten van 60 l of 1 vat van 200l. Uit rotatiegegoten blauw PE. Lage hoogte (150mm) maakt het eenvoudig om te laden en te lossen. Kan worden gebruikt met de oprijplaat OPR. Alle OPW-modellen kunnen samen worden gecombineerd tot een groot platform. Uiterst corrosieresistent. Met uitneembaar zwart PE rooster voor een eenvoudige reiniging van de opvangbak. Capaciteit conform de Vlaamse (Vlarem), Waalse en Nederlandse (CPR) milieuriichtlijnen.

Order nr.	724576200 €	
Orig. nr.	OPW2	
Capaciteit	l	2x60
Gewicht	kg	20,00
Afmetingen (l x b x h)	mm	1260 x 860 x 150
Prijs	€	356,00

TOOLS



Opvangwerkvloer voor 4 vaten van 200 l. Uit rotatiegegoten blauw PE. Lage hoogte (150mm) maakt het eenvoudig om te laden en te lossen. Kan worden gebruikt met de oprijplaat OPR. Alle OPW-modellen kunnen samen worden gecombineerd tot een groot platform. Uiterst corrosieresistent. Met 2 uitneembare zwarte PE roosters voor een eenvoudige reiniging van de opvangbak. Capaciteit conform de Vlaamse (Vlarem), Waalse en Nederlandse (CPR) milieuriichtlijnen.

Order nr.	724576400 €	
Orig. nr.	OPW4	
Capaciteit	l	4x200
Gewicht	kg	40,00
Afmetingen (l x b x h)	mm	1660 x 1260 x 150
Prijs	€	515,00

TOOLS



Opvangwerkvloer voor 4 vaten van 200 l. op 1 rij. Uit rotatiegegoten blauw PE. Lage hoogte (150mm) maakt het eenvoudig om te laden en te lossen. Kan worden gebruikt met de oprijplaat OPR. Alle OPW-modellen kunnen samen worden gecombineerd tot een groot platform. Uiterst corrosieresistent. Met 2 uitneembare zwarte PE roosters voor een eenvoudige reiniging van de opvangbak. Capaciteit conform de Vlaamse (Vlarem), Waalse en Nederlandse (CPR) milieuriichtlijnen.

Order nr.	724576405 €	
Orig. nr.	OPW4L	
Capaciteit	l	4x200
Gewicht	kg	48,00
Afmetingen (l x b x h)	mm	2610 x 895 x 150
Prijs	€	599,00

TOOLS



PE oprijplaat die in combinatie met de OPW-opvangbakken wordt gebruikt. Met deze oprijplaat kunnen pallets of vaten met een transportwagen of transpallet op de opvangwerkvloer worden geplaatst. Capaciteit conform de Vlaamse (Vlarem), Waalse en Nederlandse (CPR) milieuriichtlijnen.

Order nr.	724576490 €	
Orig. nr.	OPR	
Gewicht	kg	9,00
Afmetingen (l x b x h)	mm	2610 x 895 x 150
Prijs	€	198,00

TOOLS



Flexibele opvangbak voor 2 vaten van 200 liter. Maakt het mogelijk om een standaard houten vatenpallet om te bouwen tot lekbak. Vervaardigd uit kunststof waardoor deze gebruikt kan worden bij chemicaliën en zuren. De voorkant kan gemakkelijk omhoog en naar beneden worden gedaan zodat er een pallet in geplaatst kan worden. Geschikt voor pallets van 1200x800 mm. Capaciteit conform de Vlaamse (Vlarem), Waalse en Nederlandse (CPR) milieuriichtlijnen.

Order nr.	724576508 €	
Orig. nr.	FOP2	
Capaciteit	l	2x200
Gewicht	kg	18,00
Afmetingen (l x b x h)	mm	1450 x 1100 x 440
Prijs	€	444,00



Flexibele opvangbak voor 4 vaten van 200 liter. Maakt het mogelijk om een standaard houten vatenpallet om te bouwen tot lekbak. Vervaardigd uit kunststof waardoor deze gebruikt kan worden bij chemicaliën en zuren. De voorkant kan gemakkelijk omhoog en naar beneden worden gedaan zodat er een pallet in geplaatst kan worden. Geschikt voor pallets van 1000x1200mm. Capaciteit conform de Vlaamse (Vlarem), Waalse en Nederlandse (CPR) milieurechtlijnen.

Order nr.	724576509 €	
Orig. nr.	FOP4	
Capaciteit	l	4x200
Gewicht	kg	20,00
Afmetingen (l x b x h)	mm	1450 x 1300 x 440
Prijs	€	525,00



Opvangbak voor 1 vat van 200 liter.

- Uit rotatiegegoten geel PE.
- Uiterst corrosieresistent.
- Voorzien van vorkheftruckgaten
- Met uitneembaar zwart PE rooster voor een eenvoudige reiniging van de opvangbak.
- Capaciteit conform de Vlaamse (Vlarem), Waalse en Nederlandse (CPR) milieurechtlijnen.

Order nr.	724576502 €	
Orig. nr.	OPB12	
Capaciteit	l	1x200
Gewicht	kg	22,00
Afmetingen (l x b x h)	mm	900 x 700 x 525
Prijs	€	297,00



Opvangbak voor 1 vat van 200 liter.

- Uit rotatiegegoten geel PE.
- Uiterst corrosieresistent.
- Voorzien van vorkheftruckgaten
- Met uitneembaar zwart PE rooster voor een eenvoudige reiniging van de opvangbak.
- Capaciteit conform de Vlaamse (Vlarem), Waalse en Nederlandse (CPR) milieurechtlijnen.

Order nr.	724576502 €	
Orig. nr.	OPB12	
Capaciteit	l	1x200
Gewicht	kg	22,00
Afmetingen (l x b x h)	mm	900 x 700 x 525
Prijs	€	297,00



Opvangbak voor 4 vaten van 200 liter met laag profiel.

- Uit rotatiegegoten geel PE.
- Uiterst corrosieresistent.
- Met uitneembaar zwart PE rooster voor een eenvoudige reiniging van de opvangbak.
- Voorzien van vorkheftruckgaten
- Capaciteit conform de Vlaamse (Vlarem), Waalse en Nederlandse (CPR) milieurechtlijnen.

Order nr.	724576505 €	
Orig. nr.	OPB42	
Capaciteit	l	4x200
Gewicht	kg	25,00
Afmetingen (l x b x h)	mm	1280 x 1280 x 275
Prijs	€	467,00



Opvangbak voor 2 vaten van 200 l.

- Uit rotatiegegoten geel PE.
- Uiterst corrosieresistent.
- Met uitneembaar zwart PE rooster voor een eenvoudige reiniging van de opvangbak.
- Voorzien van 2 inkepingen onderaan voor verplaatsing met transpallet.
- Capaciteit conform de Vlaamse (Vlarem), Waalse en Nederlandse (CPR) milieurechtlijnen.

Order nr.	724576020 €	
Orig. nr.	OPB2	
Type	vaten	
Capaciteit	l	240
Draaggewicht	kg	650
Rooster	✓	
Gewicht	kg	26,00
Afmetingen (l x b x h)	mm	1220 x 820 x 330
Prijs	€	284,00



Opvangbak voor 4 vaten van 200 l.

- Uit rotatiegegoten geel PE.
- Uiterst corrosieresistent.
- Met uitneembaar zwart PE rooster voor een eenvoudige reiniging van de opvangbak.
- De opvangbak heeft 2 inkepingen onderaan voor verplaatsing met transpallet.
- Capaciteit conform de Vlaamse (Vlarem), Waalse en Nederlandse (CPR) milieurechtlijnen.

Order nr.	724576040 €	
Orig. nr.	OPB4	
Type	vaten	
Capaciteit	l	410
Draaggewicht	kg	1250
Rooster	✓	
Gewicht	kg	44,00
Afmetingen (l x b x h)	mm	1310 x 1310 x 370
Prijs	€	559,00



Opvangbak voor 2 IBC'S van 1000 l of 8 vaten van 200 l.

- Uit rotatiegegoten geel PE.
- Uiterst corrosieresistent.
- Met 3 uitneembare zwarte PE roosters voor een eenvoudige reiniging van de opvangbak.
- De opvangbak heeft 2 inkepingen onderaan voor verplaatsing met transpallet.
- Optioneel : voorzetray.
- Capaciteit conform de Vlaamse (Vlarem), Waalse en Nederlandse (CPR) milieurechtlijnen.

Order nr.	724576080 €	
Orig. nr.	OPB8	
Type	vaten	
Capaciteit	l	1140
Draaggewicht	kg	2500
Rooster	✓	
Gewicht	kg	136,00
Afmetingen (l x b x h)	mm	2560 x 1350 x 510
Prijs	€	1.469,00



Opvangbak voor 4 vaten van 200 liter met afschermrolluik. Uit rotatiegegoten geel PE. Uiterst corrosieresistent. Met uitneembaar zwart PE rooster voor een eenvoudige reiniging van de opvangbak. De opvangbak heeft 2 inkepingen onderaan voor verplaatsing met transpallet. Capaciteit conform de Vlaamse (Vlarem), Waalse en Nederlandse (CPR) milieurechtlijnen.

Order nr.	724576506 €	
Orig. nr.	OPBH42	
Capaciteit	l	4x200
Gewicht	kg	115,00
Afmetingen (l x b x h)	mm	1470 x 1420 x 2070
Prijs	€	1.649,00



Voorzettray voor OPB8. Capaciteit conform de Vlaamse (Vlarem), Waalse en Nederlandse (CPR) milieureichtlijnen.

Order nr.	724576090 €	
Orig. nr.	TRIBC	
Gewicht	kg	20,00
Afmetingen (l x b x h)	mm	2560 x 1350 x 510
Prijs	€	184,00



Opvangbak voor 1 IBC van 1000 liter. Uit rotatiegegoten geel PE. Uiterst corrosieresistent. Deze opvangbak heeft geen rooster. De IBC steunt op 4 ingebouwde steunvoeten. De opvangbak heeft 2 inkepingen onderaan voor verplaatsing met transpallet of vorkheftruck. Capaciteit conform de Vlaamse (Vlarem), Waalse en Nederlandse (CPR) milieureichtlijnen.

Order nr.	724576512 €	
Orig. nr.	OVBIBC1	
Type	IBC	
Capaciteit	l	1125
Draaggewicht	kg	1500
Gewicht	kg	80,00
Afmetingen (l x b x h)	mm	1590 x 1455 x 715
Prijs	€	1.165,00



Opvangbak voor 1 IBC van 1000 l met ingebouwde aftaptray. Uit rotatiegegoten blauw PE. Uiterst corrosieresistent. Deze opvangbak heeft geen rooster. De IBC steunt op 4 ingebouwde steunvoeten. De opvangbak heeft 2 inkepingen onderaan voor verplaatsing met transpallet. Capaciteit conform de Vlaamse (Vlarem), Waalse en Nederlandse (CPR) milieureichtlijnen.

Order nr.	724576085 €	
Orig. nr.	OPBIBC	
Capaciteit	l	1 IBC 1100
Gewicht	kg	86,00
Afmetingen (l x b x h)	mm	1950 x 1400 x 725
Prijs	€	1.309,00



Opvangbak voor 1 IBC van 1000 liter met rooster. Uit rotatiegegoten geel PE. Uiterst corrosieresistent. Geschikt voor oliën, chemicaliën en zuren. Kan worden verplaatst door een transpallet of vorkheftruck dankzij 2 inkepingen onderaan. Capaciteit conform de Vlaamse (Vlarem), Waalse en Nederlandse (CPR) milieureichtlijnen.

Order nr.	724576510 €	
Orig. nr.	OVBIBC1R	
Type	IBC	
Capaciteit	l	1100
Draaggewicht	kg	1500
Rooster	✓	
Gewicht	kg	107,00
Afmetingen (l x b x h)	mm	1760 x 1350 x 710
Prijs	€	1.359,00

TOOLS



Opvangbak voor 2 IBC's van 1000 liter. Uit rotatiegegoten geel PE. Uiterst corrosiebestendig. Deze opvangbak heeft geen rooster. De opvangbak heeft 2 inkepingen onderaan voor verplaatsing met transpallet of vorkheftruck. Capaciteit conform de Vlaamse (Vlarem), Waalse en Nederlandse (CPR) milieurechtlijnen.

Order nr.	724576514 €	
Orig. nr.	OVBIBC2	
Type	IBC	
Capaciteit	l	1150
Gewicht	kg	85,00
Afmetingen (l x b x h)	mm	2340 x 1360 x 510
Prijs	€	1.235,00

TOOLS



Opvangbak voor 2 IBC van 1000 liter met rooster. Uit rotatiegegoten geel PE. Uiterst corrosiebestendig. Geschikt voor oliën, chemicaliën en zuren. Kan worden verplaatst door een transpallet of vorkheftruck dankzij 2 inkepingen onderaan. Capaciteit conform de Vlaamse (Vlarem), Waalse en Nederlandse (CPR) milieurechtlijnen.

Order nr.	724576511 €	
Orig. nr.	OVBIBC2R	
Type	IBC	
Capaciteit	l	1140
Gewicht	kg	136,00
Afmetingen (l x b x h)	mm	2560 x 1350 x 510
Prijs	€	1.549,00

TOOLS



Trechter voor opvangbakken. Kostenbesparende en praktische manier om uw vaten of ibc's te vullen.

Order nr.	724576522 €	724576523 €
Orig. nr.	VT2	VT10
Capaciteit	vat van 200	IBC van 1000
Diameter	mm 610x230	640x150
Gewicht	kg 4,00	4,00
Prijs	€ 162,00	173,00

Veilig transport

TOOLS



Vatenkarretje uit 100 procent rotatiegegoten polyethyleen, voor 1 vat van 200 liter of voor kleinere bidons. Vier zwenkwielen waarvan er twee kunnen worden vastgezet. Ook geschikt voor het vervoeren van batterijen.

Order nr.	724576524 €	
Orig. nr.	VK2	
Gewicht	kg	15,50
Prijs	€	377,00

TOOLS



Vatenkar voor het vervoeren van kleinere bidons, batterijen en andere kleine ladingen.

Order nr.	724576525 €	
Orig. nr.	VKBB	
Gewicht	kg	18,00
Prijs	€	376,00

TOOLS



Combinatie van een vatenlift, vatenkar, opvangpallet en verdeleenheid die het mogelijk maakt dat slechts één persoon gemakkelijk alle hef- en kantelbewegingen kan uitvoeren met een vol 200 liter - vat. Onderaan twee vaste wielen en 1 zwenkwiel met rem. Twee bevestigingsriemen om vat stevig vast te zetten.

Order nr.	724576526 €	
Orig. nr.	VK1	
Gewicht	kg	44,00
Prijs	€	699,00

WERKPLAATSMEUBILAIR

Kies voor een werkplaatsinrichting van MW TOOLS

MW TOOLS biedt dé oplossing voor uw werkplaatsinrichting. Stel zelf uw werkbank samen of ga voor één van onze modules uit ons assortiment. Daarnaast kunt u ook steeds voor individuele elementen kiezen, zoals ladekasten, opbergkasten, perfopanelen en werfkoffers, zodat u uw werkplaats naar uw gemak kunt inrichten.

Stel zelf uw werkbank samen

Met MW TOOLS kunt u zelf uw werkbank samenstellen dankzij ons modulair concept. Alle werkbanken bestaan uit een werktafel en metalen voeten. Hier hoort ook nog een ladekast bij, afhankelijk van het type werkbank dat u kiest.

- Stevig multiplex werkblad van 30 mm dik
- Metalen voeten: instelbaar in de hoogte van 810 tot 1180 mm, en dit zorgt ervoor dat u altijd de meest ergonomische houding kan aannemen.

De werkbanken zijn belastbaar tot 800 kg. De metalen voeten en ladekasten zijn rood en grijs gepoederlakt. Alle elementen worden los geleverd met bevestigingsmateriaal.

Samengestelde modules

VYNCKIER biedt ook werkplaatsmeubilair aan in verschillende modules. Zo kiest u voor een werkplaatsinrichting die wij voor u samengesteld hebben. Elke werkplaatsinrichting heeft een stevig multiplex werkblad of werkbank, een perfopaneel en verschillende kasten.

- Stevig werkblad: breedte 1200 of 2000 mm - diepte 680 mm en op ergonomische werkhoogte van 977 mm.
- Perfopaneel (te bevestigen aan de muur): breedte 1200 of 2000 mm - hoogte 940 mm.
- Verschillende kasten: met 5, 8 of 10 lades of met deur en legplank.





TOOLS®

MW Werkbanken



Volledig metalen werkbank zonder laden.

Werkblad:

- 2,5 mm staalplaat
- Afgeronde hoeken

Onderstel:

- Stevig metalen onderstel
- Metalen legplaat

Kleur:

- Rood gepoederlakt

Order nr.	751001501 €	751002001 €
Orig. nr.	DER1500A	DER2000A
Maximum belastbare capaciteit	kg 500	400
Gewicht	kg 75,00	91,00
Afmetingen (l x b x h)	mm 1500 x 640 x 900	2000 x 640 x 900
Prijs	€ 367,00	377,00



Volledig metalen werkbank met laden.

Werkblad

- 2,5 mm staalplaat
- Afgeronde hoeken

Onderstel

- Stevig metalen onderstel
- Metalen legplaat

Laden

- Gelagerde laden
- Individueel afsluitbaar
- 2 (1500 mm) of 3 (2000 mm) lades

Kleur

- Rood gepoederlakt

Order nr.	751001500 €	751002000 €
Orig. nr.	DER1500	DER2000
Maximum belastbare capaciteit	kg 500	400
Lades	2	3
Draagcapaciteit per lade	kg 30	30
Gewicht	kg 83,00	103,00
Afmetingen (l x b x h)	mm 1500 x 640 x 860	2000 x 640 x 860
Prijs	€ 388,00	399,00



Volledig metalen werkbank met instelbare hoogte

Werkblad:

- 2,5 mm staalplaat
- Afgeronde hoeken
- Stevig onderstel met metalen legplaat

Laden:

- Gelagerde laden
- 2 (1500 mm) of 3 (2000 mm) laden
- Individueel afsluitbaar

Voeten:

- Verstelbaar in de hoogte 894mm - 934mm - 974mm - 1013mm

Kleur:

- Rood gepoederlakt

Order nr.	751001506 €	751002021 €
Orig. nr.	DER1500P	DER2000P
Maximum belastbare capaciteit	kg 400	300
Verstelbare voeten	✓	✓
Lades	2	3
Draagcapaciteit per lade	kg 30	30
Gewicht	kg 83,00	103,00
Afmetingen (l x b x h)	mm 1500 x 640 x 996	2000 x 640 x 996
Prijs	€ 399,00	409,00



Metalen werkbank met stalen werkblad en MDF topblad.

Werkblad:

- 2,5 mm staalplaat
- Afgeronde hoeken
- **MDF werkblad** bovenop
- Stevig onderstel met metalen legplaat

Laden:

- Gelagerde laden
- 2 (1500 mm) of 3 (2000 mm) laden
- Individueel afsluitbaar

Kleur:

- Rood gepoederlakt

Order nr.	751001503 €	751002004 €
Orig. nr.	DER1500W	DER2000W
Maximum belastbare capaciteit	kg 500	400
Lades	2	3
Draagcapaciteit per lade	kg 30	30
Gewicht	kg 103,00	123,00
Afmetingen (l x b x h)	mm 1500 x 640 x 880	2000 x 640 x 920
Prijs	€ 420,00	432,00



Volledig metalen werkbank met laden en MDF topblad.

Werkblad:

- 2,5 mm staalplaat
- Afgeronde hoeken
- **MDF werkblad** bovenop
- Stevig onderstel met metalen legplaat



Laden:

- Gelagerde laden
- 2 (1500 mm) of 3 (2000 mm) laden
- Individueel afsluitbaar

Wielen:

- 2 zwenkwielen met rem
- 2 vaste wielen

Kleur:

- Rood gepoederlakt

Order nr.	751001505 €	751002009 €
Orig. nr.	DER1500WR	DER2000WR
Maximum belastbare capaciteit	kg 500	400
Lades	2	3
Wielen	✓	✓
Draagcapaciteit per lade	kg 30	30
Gewicht	kg 108,00	128,00
Afmetingen (l x b x h)	mm 1500 x 640 x 1053	2000 x 640 x 1053
Prijs	€ 496,00	509,00



Volledig metalen werkbank met laden.

Werkblad:

- 2,5 mm staalplaat
- Afgeronde hoeken

Onderstel:

- Stevig metalen onderstel
- Metalen legplaat

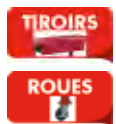

Laden:

- Gelagerde laden
- Individueel afsluitbaar
- 2 (1500 mm) of 3 (2000 mm) laden

Wielen:

- 2 zwenkwielen met rem
- 2 vaste wielen

Kleur:

- Rood gepoederlakt

Order nr.	751001504 €	751002008 €
Orig. nr.	DER1500R	DER2000R
Maximum belastbare capaciteit	kg 500	400
Lades	2	3
Wielen	✓	✓
Draagcapaciteit per lade	kg 30	30
Gewicht	kg 88,00	108,00
Afmetingen (l x b x h)	mm 1500 x 640 x 1035	2000 x 640 x 1035
Prijs	€ 475,00	485,00



Volledig metalen werkbank.

Werkblad:

- 2,5 mm staalplaat
- Afgeronde hoeken
- **MDF werkblad** bovenop
- Stevig onderstel met metalen legplaat



Laden:

- Gelagerde laden
- 2 (1500mm) of 3 (2000mm)
- Individueel afsluitbaar

Voeten:

- Verstelbaar in de hoogte 894mm - 934mm - 974mm - 1013mm

Kleur:

- Rood gepoederlakt

Order nr.	751001507 €	751002022 €
Orig. nr.	DER1500PW	DER2000PW
Maximum belastbare capaciteit	kg 400	300
Verstelbare voeten	✓	✓
Lades	2	3
Draagcapaciteit per lade	kg 30	30
Gewicht	kg 103,00	123,00
Afmetingen (l x b x h)	mm 1500 x 640 x 1013	2000 x 640 x 1013
Prijs	€ 432,00	442,00



Metalen werktafel compleet met perforandwandplaat.

Kan op zichzelf worden geplaatst zonder muurbevestiging.

Geleverd zonder haken of gereedschap. Model DER2017M en DER2017PM geleverd met 18mm MDF-werkblad.



Order nr.	751002017 €	751002019 €	751002018 €	751002020 €
Orig. nr.	DER2017	DER2017P	DER2017M	DER2017PM
Maximum belastbare capaciteit	kg 300	300	300	300
Verstelbare voeten		✓		✓
Lades	3	3	3	3
Perforaneel	2000x830	2000x830	2000x830	2000x830
Afmetingen lade (l)	mm 510x120 (3x)	510x120 (3x)	510x120 (3x)	510x120 (3x)
Gewicht	kg 128,00	128,00	140,00	140,00
Afmetingen (l x b x h)	mm 2000 x 640 x 860	2000 x 640 x 996	2000 x 640 x 860	2000 x 640 x 1013
Prijs	€ 699,00	699,00	775,00	799,00

WERKBANKEN

Stel zelf uw werktafel samen dankzij dit modulair concept. De elementen worden los geleverd met bevestigingsmateriaal. De werkbanken zijn belastbaar tot 500 kg.

Werkblad

- Tafels met een stevig multiplex werkblad
- 30mm

Onderstel

- Metalen voeten instelbaar in de hoogte (810-1180 mm)
- Altijd de meest ergonomische houding

Kleur

- Rood en grijs gepoederlakt

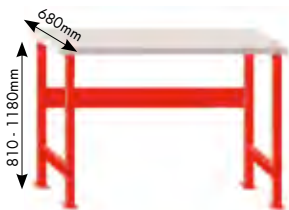

Order nr.	856001370 €
Orig. nr.	MOD120
Lades	400
Draagcapaciteit	kg 400
Werkblad	multiplex 30mm
Verstelbare voeten	✓
Gewicht	kg 50,00
Afmetingen (l x b x h)	mm 1200 x 680 x 1180
Prijs	€ 308,00



Order nr.	856001374 €
Orig. nr.	MOD124
Lades	1
Draagcapaciteit	kg 400
Werkblad	multiplex 30mm
Verstelbare voeten	✓
Afmetingen ladeblok	mm 572x525x810
Afmetingen lade (1)	mm 510x168
Gewicht	kg 50,00
Afmetingen (l x b x h)	mm 1200 x 680 x 1180
Prijs	€ 410,00



Order nr.	856001375 €
Orig. nr.	MOD125
Lades	3
Draagcapaciteit	kg 400
Werkblad	multiplex 30mm
Verstelbare voeten	✓
Afmetingen ladeblok	mm 572x525x470
Afmetingen lade (1)	mm 510x90 (2x)
Afmetingen lade (2)	mm 510x168 (1x)
Gewicht	kg 50,00
Afmetingen (l x b x h)	mm 1200 x 680 x 1180
Prijs	€ 485,00



Order nr.	856001371 €
Orig. nr.	MOD121
Lades	5
Draagcapaciteit	kg 400
Werkblad	multiplex 30mm
Afmetingen ladeblok	mm 572x525x870
Afmetingen lade (1)	mm 510x90 (3x)
Afmetingen lade (2)	mm 510x168 (2x)
Gewicht	kg 50,00
Afmetingen (l x b x h)	mm 1200 x 680 x 810
Prijs	€ 515,00

TOOLS



Order nr.	856001360 €
Orig. nr.	MOD200
Draagcapaciteit	kg 300
Werkblad	multiplex 30mm
Verstelbare voeten	✓
Gewicht	kg 50,00
Afmetingen (l x b x h)	mm 2000 x 680 x 1180
Prijs	€ 345,00

TOOLS



Order nr.	856001364 €
Orig. nr.	MOD204
Lades	1
Draagcapaciteit	kg 300
Werkblad	multiplex 30mm
Verstelbare voeten	✓
Afmetingen ladeblok	mm 572x525x810 (2x)
Afmetingen lade (1)	mm 510x168
Gewicht	kg 50,00
Afmetingen (l x b x h)	mm 2000 x 680 x 1180
Prijs	€ 464,00

TOOLS



Order nr.	856001365 €
Orig. nr.	MOD205
Lades	3
Draagcapaciteit	kg 300
Werkblad	multiplex 30mm
Verstelbare voeten	✓
Afmetingen ladeblok	mm 572x525x470
Afmetingen lade (1)	mm 510x90 (2x)
Afmetingen lade (2)	mm 510x168 (1x)
Gewicht	kg 50,00
Afmetingen (l x b x h)	mm 2000 x 680 x 1180
Prijs	€ 555,00

TOOLS



Order nr.	856001361 €
Orig. nr.	MOD201
Lades	5
Draagcapaciteit	kg 400
Werkblad	multiplex 30mm
Afmetingen ladeblok	mm 572x525x810
Afmetingen lade (1)	mm 510x90 (3x)
Afmetingen lade (2)	mm 510x168 (2x)
Gewicht	kg 50,00
Afmetingen (l x b x h)	mm 2000 x 680 x 810
Prijs	€ 520,00

TOOLS



Order nr.	856001366 €
Orig. nr.	MOD206
Lades	2x5
Draagcapaciteit	kg 400
Werkblad	multiplex 30mm
Afmetingen ladeblok	mm 572x525x810 (2x)
Afmetingen lade (1)	mm 510x90 (3x)
Afmetingen lade (2)	mm 510x168 (2x)
Gewicht	kg 50,00
Afmetingen (l x b x h)	mm 2000 x 680 x 810
Prijs	€ 742,00

TOOLS



Order nr.	856001367 €
Orig. nr.	MOD207
Lades	2x5 + 4
Draagcapaciteit	kg 400
Werkblad	multiplex 30mm
Afmetingen ladeblok	mm 572x525x810 (2x)
Afmetingen lade (1)	mm 510x90 (8x)
Afmetingen lade (2)	mm 510x168 (6x)
Gewicht	kg 50,00
Afmetingen (l x b x h)	mm 2000 x 680 x 810
Prijs	€ 1.029,00

EQUIPMENT

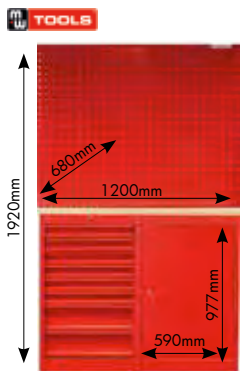

Complete set modulaire werkplaatsinrichting.

Stevig multiplex werkblad

- Breedte 1200 mm x diepte 680 mm
- Op ergonomische werkhoogte 977 mm

Perfopaneel

- Breedte 1200 mm x hoogte 940 mm
- Te bevestigen aan de muur
- Geschikt voor MOD haken

Kast

- DELK8 + DEK5962

Order nr.	856001450		
Orig. nr.	MOD12LA		
Gewicht	kg	1,00	
Afmetingen (l x b x h)	mm	1200 x 628 x 950	
Prijs	€	935,00	

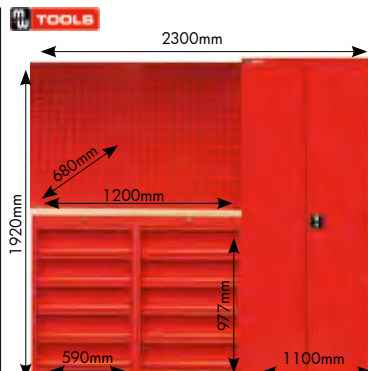

Complete set modulaire werkplaatsinrichting.

Stevig multiplex werkblad

- Breedte 1200 mm x diepte 680 mm
- Op ergonomische werkhoogte 977 mm

Perfopaneel

- Breedte 1200 mm x hoogte 940 mm
- Te bevestigen aan de muur
- Geschikt voor MOD haken

Kast

- 2x DELK5 + DEK11058

Order nr.	856001452		
Orig. nr.	MOD12LBK		
Gewicht	kg	1,00	
Afmetingen (l x b x h)	mm	1200 x 628 x 950	
Prijs	€	1.679,00	

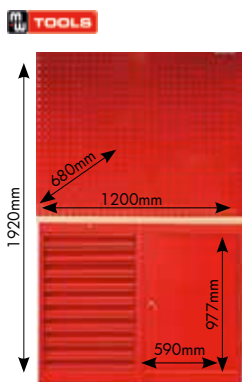

Complete set modulaire werkplaatsinrichting.

Stevig multiplex werkblad

- Breedte 1200 mm x diepte 680 mm
- Op ergonomische werkhoogte 977 mm

Perfopaneel

- Breedte 1200 mm x hoogte 940 mm
- Te bevestigen aan de muur
- Geschikt voor MOD haken

Kast

- DELK10 + DEK5962

Order nr.	856001453		
Orig. nr.	MOD12LD		
Gewicht	kg	1,00	
Afmetingen (l x b x h)	mm	1200 x 628 x 950	
Prijs	€	949,00	

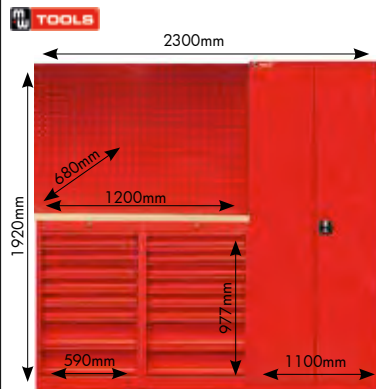

Complete set modulaire werkplaatsinrichting.

Stevig multiplex werkblad

- Breedte 1200 mm x diepte 680 mm
- Op ergonomische werkhoogte 977 mm

Perfopaneel

- Breedte 1200 mm x hoogte 940 mm
- Te bevestigen aan de muur
- Geschikt voor MOD haken

Kast

- 2x DELK8 + DEK11058

Order nr.	856001451		
Orig. nr.	MOD12LCK		
Gewicht	kg	1,00	
Afmetingen (l x b x h)	mm	1200 x 628 x 950	
Prijs	€	1.735,00	

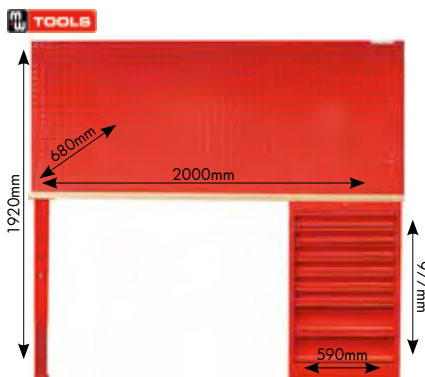

Complete set modulaire werkplaatsinrichting.

Stevig multiplex werkblad

- Breedte 2000 mm x diepte 680 mm
- Op ergonomische werkhoogte 977 mm

Perfopaneel

- Breedte 2000 mm x hoogte 940 mm
- Te bevestigen aan de muur
- Geschikt voor MOD haken

Kast

- DELK8

Order nr.	856001457	
Orig. nr.	MOD20LA	
Gewicht	kg	1,00
Prijs	€	825,00

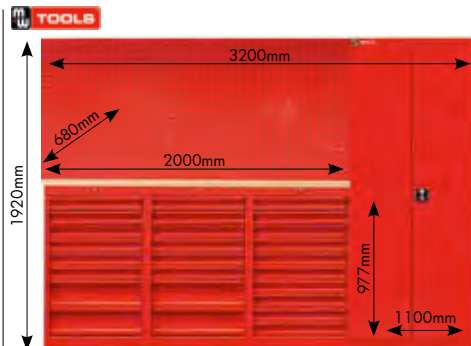

Complete set modulaire werkplaatsinrichting.

Stevig multiplex werkblad

- Breedte 2000 mm x diepte 680 mm
- Op ergonomische werkhoogte 977 mm

Perfopaneel

- Breedte 2000 mm x hoogte 940 mm
- Te bevestigen aan de muur
- Geschikt voor MOD haken

Kast

- 2 x DELK8 + DELK10 + DEK11058

Order nr.	856001454	
Orig. nr.	MOD20LDK	
Gewicht	kg	1,00
Afmetingen (l x b x h)	mm	2000 x 628 x 950
Prijs	€	2.325,00

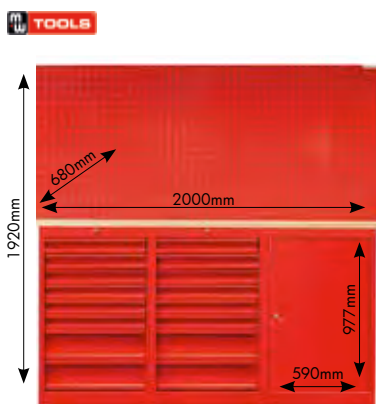

Complete set modulaire werkplaatsinrichting.

Stevig multiplex werkblad

- Breedte 2000 mm x diepte 680 mm
- Op ergonomische werkhoogte 977 mm

Perfopaneel

- Breedte 2000 mm x hoogte 940 mm
- Te bevestigen aan de muur
- Geschikt voor MOD haken

Kast

- 2 x DELK8 + DEK11058

Order nr.	856001456	
Orig. nr.	MOD20LB	
Gewicht	kg	1,00
Afmetingen (l x b x h)	mm	2000 x 628 x 950
Prijs	€	1.509,00

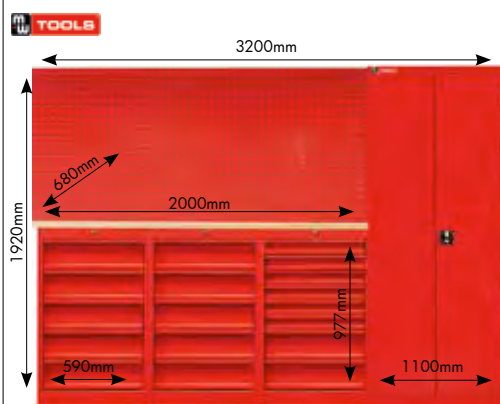

Complete set modulaire werkplaatsinrichting.

Stevig multiplex werkblad

- Breedte 2000 mm x diepte 680 mm
- Op ergonomische werkhoogte 977 mm

Perfopaneel

- Breedte 2000 mm x hoogte 940 mm
- Te bevestigen aan de muur
- Geschikt voor MOD haken

Kast

- 2 x DELK5 + DELK8 + DEK11058

Order nr.	856001455	
Orig. nr.	MOD20LCK	
Gewicht	kg	1,00
Afmetingen (l x b x h)	mm	2000 x 628 x 950
Prijs	€	2.259,00

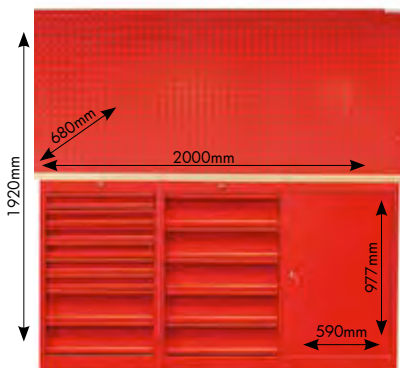

Complete set modulaire werkplaatsinrichting.

Stevig multiplex werkblad

- Breedte 2000 mm x diepte 680 mm
- Op ergonomische werkhoogte 977 mm

Perfopaneel

- Breedte 2000 mm x hoogte 940 mm
- Te bevestigen aan de muur
- Geschikt voor MOD haken

Kast

- DELK5 + DELK8 + DEK11058

Order nr.	856001458 €
Orig. nr.	MOD20LC
Gewicht	kg 1,00
Prijs	€ 1.489,00



Stabiele, opklapbare werkbank met watervast bovenblad in multiplex.

Gemakkelijk op te plooiën en op te bergen. Ideaal voor gebruik op de werf of kleine werkruimtes.

Order nr.	713900030 €
Orig. nr.	DETW10070
Maximum belastbare capaciteit	kg 250
Werkblad	multiplex
Plooibaar	✓
Gewicht	kg 36,00
Afmetingen (l x b x h)	mm 1000 x 700 x 830
Prijs	€ 172,00

MW Wandpanelen & wandkasten



Metalen geperforeerde wandplaat.

Kenmerken:

- Tussenafstand perforatie 8mm.
- Diameter perforatie 5mm.

Geleverd zonder gereedschap noch haken.

Order nr.	751501102 €
Orig. nr.	DERGR17
Lengte	mm 2000
Hoogte	mm 830
Gewicht	kg 13,00
Prijs	€ 167,00

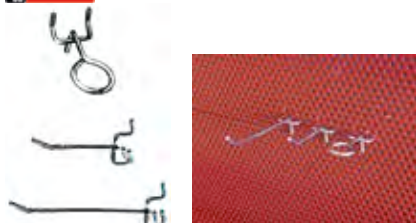

Stalen verchroomde haken voor de geperforeerde wandplaten voor DERGR17.

Order nr.	751600010 €	751607000 €	751601000 €
Orig. nr.	DERR10	DERH70	DERH100
Omschrijving	ronde haak	rechte haak, lengte 70mm	rechte haak, lengte 100mm
Gewicht	kg 0,10	0,10	0,10
Prijs	€ 1,60	1,60	1,80

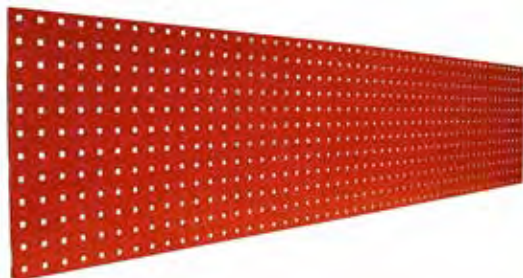

Vlak metalen perforpaneel geschikt voor de MOD-haken. Te monteren op de muur.

Order nr.	856001342	856001178	856001177
	€	€	€
Orig. nr.	MODP2000	DEKP118	DEKP200
Breedte	mm 2000	1180	2000
Hoogte	mm 460	940	940
Diepte	mm 20	20	20
Perforatie	mm 10x10	10x10	10x10
Hart-op-hart afstand	mm 38x38	38x38	38x38
Gewicht	kg 9,50	10,00	16,00
Afmetingen (l x b x h)	mm 2000 x 20 x 460	1180 x 20 x 940	2000 x 20 x 940
Prijs	€ 122,00	83,50	117,00

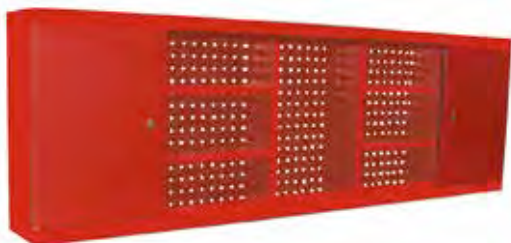

Muurkast met geperforeerde achterwand en 2 afsluitbare deuren.

Kenmerken:

- 4 liggers
- Voorzien om op de muur of op de optionele houders te monteren

Order nr.	856001326	856001351
	€	€
Orig. nr.	MODM1200	MODM1850
Lengte	mm 1200	1950
Breedte	mm 200	200
Hoogte	mm 600	600
Gewicht	kg 50,00	42,00
Prijs	€ 187,00	253,00

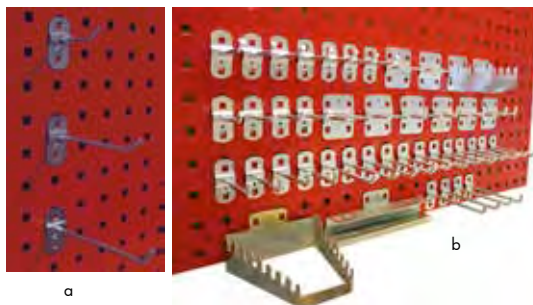

Haken en klemmen passend op

- perforpanelen DEKP118/200, MODP2000, MODM1200/1850
- gereedschapskarren GW107/115, GW207R/G.

Order nr.	856001504	856001505	856001507	856001551
	€	€	€	€
Orig. nr.	MOD23105	MOD23115	MOD23117	MOD23201
Type	a	a	a	b
Omschrijving	haak 45° 50 mm	haak 45° 100 mm	haak 45° 200 mm	45-delige hakenset Modular
Gewicht	kg 1,00	1,00	1,00	1,00
VE	1	1	1	1
Min. bestelhoeveelheid	5	5	5	1
Prijs/VE	€ 1,30	1,40	1,80	64,90



Houders muurkast voor het monteren van muurkast MODM1200/1850 op werkbank MODULAR.

Order nr.	856001328
	€
Orig. nr.	MODMHK
Gewicht	kg 50,00
Prijs	€ 42,50

MW Ladekasten



Kast met 5 laden.

Kenmerken:

- 5 laden (hoogte: 145mm)
- Stevige stalen constructie uit 0,7 - 1,0mm staalplaat
- Laden 100% uittrekbaar
- Met rolgelagerde geleiders
- Met cilinderslot

Bestemd voor vaste opstelling (niet voor mobiele werkplaatsen)

Order nr.	856001168 €		
Orig. nr.	DELK5		
Lades	5		
Afmetingen lade (1)	mm	498x552x145 (5x)	
Draagcapaciteit per lade	kg	40	
Gewicht	kg	57,00	
Afmetingen (l x b x h)	mm	590 x 628 x 950	
Prijs	€	488,00	



Kast met 8 laden.

Kenmerken:

- 8 laden (hoogte: 6 x 65mm + 2 x 145mm)
- Stevige stalen constructie uit 0,7-1,0mm staalplaat
- Laden 100% uittrekbaar
- Met rolgelagerde geleiders
- Met cilinderslot

Bestemd voor vaste opstelling (niet voor mobiele werkplaatsen)

Order nr.	856001169 €		
Orig. nr.	DELK8		
Lades	8		
Afmetingen lade (1)	mm	498x552x65 (6x)	
Afmetingen lade (2)	mm	498x552x145 (2x)	
Draagcapaciteit per lade	kg	40	
Gewicht	kg	72,00	
Afmetingen (l x b x h)	mm	590 x 628 x 950	
Prijs	€	535,00	



Kast met 10 laden.

Kenmerken:

- 10 laden (hoogte: 65mm)
- Stevige stalen constructie uit 0,7 - 1,0mm staalplaat
- Laden 100% uittrekbaar
- Met rolgelagerde geleiders
- Met cilinderslot

Bestemd voor vaste opstelling (niet voor mobiele werkplaatsen)

Order nr.	856001170 €		
Orig. nr.	DELK10		
Lades	10		
Afmetingen lade (1)	mm	498x552x65 (10x)	
Draagcapaciteit per lade	kg	40	
Gewicht	kg	79,00	
Afmetingen (l x b x h)	mm	590 x 628 x 950	
Prijs	€	545,00	



Kast met legplank.

Kenmerken:

- Deur + legplank.
- Stevige stalen constructie uit 0,7 - 1,0mm staalplaat.
- Met cilinderslot.

Order nr.	856001173 €		
Orig. nr.	DEK5962		
Deuren	✓		
Liggers	1		
Gewicht	kg	1,00	
Afmetingen (l x b x h)	mm	590 x 628 x 950	
Prijs	€	226,00	



Lade-indeling 4x4 vakjes voor ladekasten DELK5, DELK8 en DELK10.

Order nr.	856001184 €		
Orig. nr.	DELKV		
Gewicht	kg	1,00	
Prijs	€	22,90	



Kast met 7 laden.

Kenmerken:

- 7 laden (hoogte: 2 x 50mm + 5 x 117mm)
- Stevige stalen constructie uit 0,7-1,0mm staalplaat
- Laden 85% uittrekbaar of 55cm
- Met rolgelagerde geleiders
- Met cilinderslot
- Rood gepoederlakt
- Rubber beschermingstop op het bovenblad
- Mogelijkheid tot opdeling van de laden

Bestemd voor vaste opstelling (niet voor mobiele werkplaatsen)

Order nr.	751501203 €		
Orig. nr.	DERLK7		
Lades	7		
Afmetingen lade (1)	mm	610x645x50 (2x)	
Afmetingen lade (2)	mm	610x645x117 (5x)	
Gewicht	kg	103,00	
Afmetingen (l x b x h)	mm	715 x 725 x 980	
Prijs	€	629,00	



Kast met 10 laden.

Kenmerken:

- 10 laden (hoogte: 8 x 50mm + 2 x 117mm)
- Stevige stalen constructie uit 0,7-1,0mm staalplaat
- Laden 85% uittrekbaar of 55 cm
- Met rolgelagerde geleiders
- Met cilinderslot
- Rood gepoederlakt
- Rubber beschermingstop op het bovenblad
- Mogelijkheid tot opdeling van de laden

Bestemd voor vaste opstelling (niet voor mobiele werkplaatsen)

Order nr.	751501210 €		
Orig. nr.	DERLK10S		
Lades	10		
Afmetingen lade (1)	mm	610x645x50 (8x)	
Afmetingen lade (2)	mm	610x645x117 (2x)	
Gewicht	kg	110,00	
Afmetingen (l x b x h)	mm	715 x 725 x 980	
Prijs	€	805,00	



Compartmenteersset voor ladekasten STAR DERLK. Bestaande uit 18 (3x6) gelijke onderverdelingen.

Order nr.	751501304 €		
Orig. nr.	DERLK7S		
Aantal compartimenten	18		
Afmetingen per compartiment (l x b x h)	mm	200x100x45	
Gewicht	kg	5,00	
Afmetingen (l x b x h)	mm	600 x 600 x 45	
Prijs	€	52,50	



Handige materiaalbak met 4 afsluitbare lades en een open opbergvak bovenaan.



Kenmerken:

- De lades zijn 100% uittrekbaar
- Rubber berschermmat bovenaan
- 2 handgrepen
- Rolgelagerde geleiders
- Kan onder alle modular werkbanken worden gereden

Order nr.	856001325 €		
Orig. nr.	MODK440		
Lengte	mm	440	
Breedte	mm	530	
Hoogte	mm	750	
Gewicht	kg	35,00	
Prijs	€	256,00	



Ladeblok met 1, 3 of 5 lades.

Kenmerken:

- Met cilinderslot.
- De lades zijn 100% uittrekbaar.
- Rolgelagerde geleiders.
- Stevige stalen constructie uit 0,7 - 1,0 mm staalplaat.
- Inclusief tussenschotten (zie tabel).

Order nr.	856001345 €	856001346 €	856001347 €
Orig. nr.	MOD1L	MOD3L	MOD5L
Lades	1	3	5
Breedte	mm 572	572	572
Diepte	mm 525	525	525
Hoogte	255	470	810
Capaciteit	kg 50	50	50
Type	hangend	hangend	staand
Gewicht	kg 50,00	36,00	50,00
Afmetingen (l x b x h)	mm 572 x 525 x 250	572 x 525 x 500	572 x 635 x 810
Prijs	€ 145,00	232,00	399,00



Ladeverdeling (h = 62mm) voor ladeblokken MOD1L/3L/5L.

Order nr.	856001350 €		
Orig. nr.	MODLV62		
Gewicht	kg	2,50	
Prijs	€	21,90	

MW Universele kasten



Universele opbergkast met liggers.

Kenmerken:

- Stevige gelaste stalen constructie.
- 4 liggers met capaciteit 50 kg, in hoogte verstelbaar.
- 2-punt slot.
- Gepoederlakt.
- Deuren draaien tot 180° open.



Order nr.	856001000	856001110	856001120
	E	E	E
Orig. nr.	DEK7838	DEK11038	DEK11058
Draagcapaciteit	kg 50	50	50
Materie	metaal	metaal	metaal
Liggers	4	4	4
Slot	ja	sleutel	sleutel
Gewicht	kg 50,00	80,00	85,00
Afmetingen (l x b x h)	mm 780 x 380 x 1920	1100 x 380 x 1920	1100 x 580 x 1920
Prijs	€ 355,00	395,00	456,00



Universele kast met liggers en lades.

Kenmerken:

- Met 3 lades en perfwand/deur.
- Stevige, gelaste constructie
- 4 liggers capaciteit 50kg in hoogte verstelbaar.
- 2-punt slot.
- Gepoederlakt.
- Compatibel met modular haken.



Order nr.	856001310
	E
Orig. nr.	DEK7838L
Draagcapaciteit	kg 50
Materie	metaal
Lades	3
Liggers	4
Slot	sleutel
Aantal deuren	2
Gewicht	kg 50,00
Afmetingen (l x b x h)	mm 780 x 380 x 1920
Prijs	€ 460,00

MW Bakjeskasten



Stalen bakjeskast met uitneembare kunststofbakjes.

Kenmerken:

- Met metalen tussenschotten tussen de rijen bakjes.
- Stevig gelast frame.
- Gepoederlakt.
- Gemonteerd geleverd

Order nr.	856001210	856001300	856001200
	E	E	E
Orig. nr.	DEBK30	DEBK48	DEBK114
Materie	metaal	metaal	metaal
Aantal bakjes	27 x ISPA04	48 x ISPA03	114 x ISPA02
Gewicht	kg 50,00	50,00	50,00
Afmetingen (l x b x h)	mm 650 x 405 x 1920	650 x 290 x 1920	650 x 200 x 1920
Prijs	€ 335,00	367,00	314,00



Stalen bakjeskast

Kenmerken:

- 2 afsluitbare deuren
- Uitneembare kunststofbakjes
- Metalen tussenschotten tussen de rijen bakjes
- Stevig gelast frame
- Gepoederlakt
- Gemonteerd geleverd
- Cilinderslot

Order nr.	856001211	856001301	856001201
	E	E	E
Orig. nr.	DEBK30D	DEBK48D	DEBK114D
Materie	metaal	metaal	metaal
Slot	ja	ja	ja
Aantal bakjes	27 x ISPA04	48 x ISPA03	114 x ISPA02
Gewicht	kg 50,00	50,00	50,00
Afmetingen (l x b x h)	mm 650 x 450 x 1920	650 x 285 x 1920	650 x 205 x 1920
Prijs	€ 392,00	399,00	442,00



Metalen bakjesrek met 30 plastic bakjes.

Order nr.	751500580 €	
Orig. nr.	DERB580	
Afmetingen per compartiment (l x b x h)	mm	13.3x11.2x3.8
Aantal bakjes	30	
Gewicht	kg	15,00
Afmetingen (l x b x h)	mm	685 x 135 x 580
Prijs	€	112,00

MW Magazijnbakjes



Stevig opbergbakje vervaardigd uit polyurethaan.

Kenmerken:

- Met kaartvakje aan de voorkant.
- met ophanglip achteraan voor bakjesrekken
- Blauwe uitvoering.

Niet geschikt voor de VTC-inrichtingen.

VE = verpakkingseenheid.

Order nr.	Orig. nr.	Gewicht kg	VE	Afmetingen (l x b x h) mm	Prijs/VE €
755002020 €	ISPA02	8,44	96	165 x 100 x 82	85,00
755003030 €	ISPA03	12,69	48	230 x 153 x 125	119,00
755004040 €	ISPA04	12,84	24	335 x 210 x 175	129,00
755005050 €	ISPA05	4,14	4	475 x 308 x 187	45,00



Stevig opbergbakje vervaardigd in PP.

Breekt niet door blootstelling aan de zon.

VE = verpakkingseenheid.



Order nr.	815614110	815614150	815614120
Orig. nr.	DBOC21	DBOC26	DBOC31
Gewicht kg	0,21	0,23	0,46
Afmetingen (l x b x h) mm	148 x 240 x 125	148 x 270 x 125	209 x 335 x 160
Prijs €	114,00	77,90	216,00



Rail uit metaal voor het ophangen van magazijnbakjes aan bv. een muur.

Kenmerk:

- Lengte = 50 cm.



Order nr.	755000101 €	
Orig. nr.	ISRAIL	
Gewicht	kg	0,10
Prijs	€	6,60

MW Kleerkasten



Kleerkast.

Kenmerken:

- 2- of 3-deurs met 2 of 3 compartimenten, ligger en 4 haken
- Cilinderslot en deurventilatie
- Hamerslag gelakt

Order nr.	856001312	856001313
Orig. nr.	DEK2	DEK3
Materie	metaal	metaal
Liggers	2	2
Slot	sleutel	sleutel
Aantal deuren	2	3
Gewicht	kg	50,00
Afmetingen (l x b x h)	mm	600 x 500 x 1800
Prijs €	220,00	297,00

MW Milieukasten



EQUIPMENT



Milieukast.

Geschikt voor stockage van diverse veilig op te bergen vloeistoffen en producten.

Kenmerken:

- Stevige gelaste stalen constructie.
- 6 waterdichte, verzinkte opvangbakken met capaciteit 30 kg, in hoogte verstelbaar
- Ventilatieschacht bovenaan en ventilatiegaten in achterwand.
- 2-punt slot.
- Gepoederlakt.
- Deuren draaien tot 180° open.

Order nr.	856001130 €	
Orig. nr.	DEC9238	
Draagcapaciteit	kg	30
Materie	metaal	
Liggers	6	
Geschikt voor vloeistoffen	✓	
Slot	sleutel	
Gewicht	kg	75,00
Afmetingen (l x b x h)	mm	920 x 380 x 1920
Prijs	€	496,00

MW Brandwerende kasten



Brandveiligheidskasten.

Kenmerken:

- Met een brandwerendheid van 90 minuten bepaald volgens de Europese Norm EN 14470-1
- Geschikt voor veilige opslag van ontvlambare stoffen
- Kwalitatief hoogwaardige kastromp uit Zincor plaatstaal
- Standaard ingericht met 3 verstelbare legborden en verstelpootjes
- Bodempvang met inzetrooster
- Zelfsluitend door middel van hydraulische deurdraner
- Thermolock op ± 45°C (automatisch)

Order nr.	724576527 €	724576528 €
Orig. nr.	BVK1	BVK2
Aantal deuren	1	2
Gewicht	kg	230,00
Afmetingen (l x b x h)	mm	600 x 600 x 2035
Prijs	€	2.789,00
		2.999,00

Teng Tools werkbanken

TENGOOLS

NEW



Werkbank met stevige laminaat bovenplaat en zwarte randen. Verstelbare voeten, voor een werkhoogte van 707 tot 927 mm.

Order nr.	238060107	238060206
Orig. nr.	TWB1500	TWB2000
Plaatdikte	mm 37	37
Lengte werkblad	mm 1500	2000
Werkhoogte	mm 707-927	707-927
Gewicht	kg 58,50	70,40
Prijs	€ 345,60	439,90

TENGOOLS

NEW

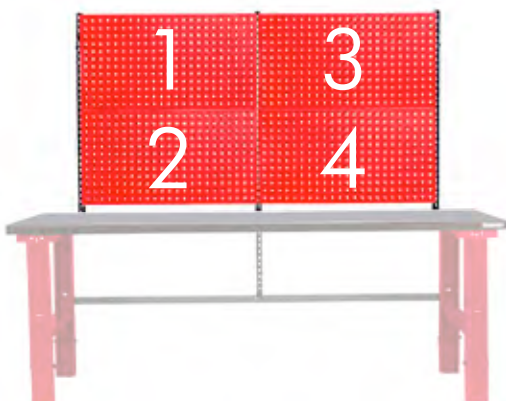

Perforpanelen voor werkbank TWB1500.

Order nr.	238070106	238070205
Orig. nr.	TWB-1500A	TWB-2000A
Omschrijving	2 panelen	4 panelen
Gewicht	kg 30,00	31,30
Afmetingen (l x b x h)	mm 892 x 30 x 966	1784 x 30 x 966
Prijs	€ 153,20	283,60

TENGOOLS



LED lamp AC/DC met magneet.

Order nr.	173420209
Orig. nr.	589ME
Breedte	mm 660
Spanning	V 230
LED	W 7.2
Capaciteit	lumen 2040
Gewicht	kg 1,22
Afmetingen (l x b x h)	mm 49 x 94 x 766
Prijs	€ 87,90

Houten werkbanken

holzkraft



HB1901



HB2004

Houten schaaft werkbank in massieve beuk voor semi-professioneel gebruik of voor de hobbyist.

Troeven:

- Precies en zorgvuldig afgewerkt
- Met 4 bankhaken, 2 rijen gaten en 2 houtklemmen
- Ongemonteerd geleverd
- Model HB2004 geleverd met 1 voorklem en 1 zijklem. Geolied bovenblad

Order nr.	715101411	715101911	715102019
Orig. nr.	HB1401	HB1901	HB2004
Plaatdikte	mm 30	30	40
Lengte werkblad	mm 1500x650	2000x650	2120x760
Lengte voorklem/achterklem	mm 360 / 360	360 / 360	500 / 470
Breedte voorklem/achterklem	mm 55 / 55	55 / 55	60 / 120
Verspreiding voorklem/achterklem	mm 160 / 160	160 / 160	210 / 180
Gewicht	kg 47,00	55,00	87,00
Afmetingen (l x b x h)	mm 1350 x 500 x 820	1980 x 650 x 820	2120 x 760 x 860
Prijs	€ 494,00	535,00	959,00

EQUIPMENT

Hotzkraft



HB2006

Professionele houten werkbank voor schrijnwerkers. Europese kwaliteit

Troeven:

- Robuuste uitvoering
- Vervaardigd uit gestoomde beuk, met afgeronde hoeken en stevig geolied bovenblad (50mm).
- Zijklemmen, voorklem met stabiele gietijzeren lineaire geleiding en gemakkelijk te bedienen hendel. Zijklem met vingerlasverbindingen
- Met 2 korte en 2 lange bankhaken die het opspannen van werkstukken met speciale vormen vergemakkelijkt (driehoeken, ronde vormen, ...)
- Bankhaakkoppen uit zacht aluminium, wat beschadiging aan het werkstuk vermijdt. De schuin aflopende koppen zorgen voor de optimale klemming. Door de zijdelingse rij kogels, zijn de bankhaken gemakkelijk in hoogte regelbaar

Geslacht voor:

- Schrijnwerkers

Tip: U kunt uw houten werkbank HB2007 uitbreiden met een kiplade 715102142, of met 4 laden en twee deuren 715102140.

Order nr.	715102070 M		
Orig. nr.	HB2007		
Plaatdikte	mm	50	
Lengte werkblad	mm	1915x615	
Lengte voorklem/achterklem	mm	520x450	
Breedte voorklem/achterklem	mm	55x15	
Verspreiding voorklem/achterklem	mm	165x190	
Werkhoogte	mm	870	
Gewicht	kg	85,00	
Afmetingen (l x b x h)	mm	2000 x 650 x 820	
Prijs	€	1.029,00	

Hotzkraft



Zware houten werkbank voor schrijnwerkers. Europese kwaliteit

Troeven:

- Robuuste uitvoering
- Vervaardigd uit gestoomde beuk, met afgeronde hoeken en stevig geolied bovenblad (50mm).
- Zijklemmen, voorklem met stabiele gietijzeren lineaire geleiding en gemakkelijk te bedienen hendel. Zijklem met vingerlasverbindingen.
- Met 2 korte en 2 lange bankhaken die het opspannen van werkstukken met speciale vormen vergemakkelijkt (driehoeken, ronde vormen, ...).
- Bankhaakkoppen uit zacht aluminium, wat beschadiging aan het werkstuk vermijdt. De schuin aflopende koppen zorgen voor de optimale klemming. Door de zijdelingse rij kogels, zijn de bankhaken gemakkelijk in hoogte regelbaar.

Geslacht voor:

- schrijnwerkers

Order nr.	715102102 M		
Orig. nr.	HB2010		
Plaatdikte	mm	50	
Werkoppervlak (zonder bankschroef)	mm	1910x615	
Lengte voorklem/achterklem	mm	520/460	
Breedte voorklem/achterklem	mm	170/190	
Verspreiding voorklem/achterklem	mm	50x110	
Werkhoogte	mm	870	
Gewicht	kg	85,00	
Afmetingen (l x b x h)	mm	2000 x 650 x 820	
Prijs	€	1.349,00	

Hotzkraft



Accessoires voor HB2006.

Order nr.	715102151 M	715102152 M
Orig. nr.	5102151	5102152
Omschrijving	set van 2 lange haken	set van 2 korte haken
Gewicht	kg	1,00
Prijs	€	80,90
		76,50

MW Werkkoffers



Handige Metalworks werkkoffer.

Kenmerken:

- Gelaste staalplaat van 1 tot 1,2mm
- Rood poederlak
- 1 sluiting (type 550 en 670) of 2 sluitingen (800 en 1000)
- Afsluitbaar met hangslot (niet meegeleverd)
- Met 2 stevige handvaten en 2 scharnieren

Order nr.		758121550 €	758121670 €	758121800 €	758121100 €
Algemeen					
Orig. nr.		SORCR550B	SORCR670B	SORCR800B	SORCR1000B
Volume	l	60	67	80	198
Staaldikte	mm	1,0-1,2	1,0-1,2	1,0-1,2	1,0-1,2
Materie		staal	staal	staal	staal
Afmetingen					
Inwendige lengte	mm	555	689	819	1019
Inwendige breedte	mm	328	379	389	509
Inwendige hoogte	mm	300	352	355	360
Gewicht	kg	10,00	13,50	15,00	20,00
Afmetingen (l x b x h)	mm	590 x 355 x 310	720 x 405 x 362	850 x 415 x 365	1050 x 535 x 370
Prijs	€	70,90	82,50	106,00	143,00



Metalworks werkkoffer.

Kenmerken:

- Stevige staalplaat van 1,5 en 5mm (naargelang type).
- Kleur : mat rood gepoederlakt.
- Rondom de koffer is een anti-inbraak rand die geforceerd openen onmogelijk maakt.
- 2 stevige opklapbare stalen handgrepen.
- 2 hydraulische hulpveren voor een soepel openen van het deksel.
- Sluiting van de koffer met 2 Eurotype-cilindersloten verzonken in de koffer.
- Sterke gelaste pianoscharnier over de volledige lengte van het kofferdeksel.

Geleverd met 6 sleutels per koffers.

Order nr.		758120195 €	758120265 €
Algemeen			
Orig. nr.		MWB195	MWB265
Volume	l	195	265
Staaldikte	mm	1,5 - 3	1,5 - 5
Afmetingen			
Inwendige lengte	mm	910	1255
Inwendige breedte	mm	445	445
Inwendige hoogte	mm	440	425
Gewicht	kg	36,60	52,50
Afmetingen (l x b x h)	mm	955 x 485 x 455	1300 x 500 x 460
Prijs	€	284,00	376,00

EQUIPMENT



MWB445



MWB700



MWB445



MWB700

EQUIPMENT

Metalworks werfkoffer.

Kenmerken:

- Stevige staalplaat van 1,5 en 5mm (naargelang type).
- Kleur : mat rood gepoederlakt.
- Rondom de koffer is een anti-inbraak rand die geforceerd openen onmogelijk maakt.
- 2 stevige opklapbare stalen handgrepen.
- 2 hydraulische hulpveren voor een soepel openen van het deksel.
- Sluiting van de koffer met 2 Eurotype-cilindersloten verzonken in de koffer.
- Sterke gelaste pianoscharnier over de volledige lengte van het kofferdeksel.
- Voorzien van 2 vorksheuven voor manipulatie met een vorkheftruck.



Geleverd met 6 sleutels per koffers.

Order nr.		758120445	758120700
Algemeen			
Orig. nr.		MWB445	MWB700
Volume	l	445	700
Staaldikte	mm	2 - 5	2 - 5
Afmetingen			
Inwendige lengte	mm	1100	1810
Inwendige breedte	mm	595	595
Inwendige hoogte	mm	525	510
Gewicht	kg	71,50	114,20
Afmetingen (l x b x h)	mm	1135 x 635 x 600	1840 x 635 x 610
Prijs	€	483,00	719,00



MWB905



MWB905

Metalworks werfkoffer

Kenmerken:

- Stevige staalplaat van 1,5 en 5mm (naargelang type).
- Rondom de koffer is een anti-inbraak rand die geforceerd openen onmogelijk maakt.
- 2 stevige opklapbare stalen handgrepen.
- 2 hydraulische hulpveren voor een soepel openen van het deksel.
- Sluiting van de koffer met 2 Eurotype-cilindersloten verzonken in de koffer.
- Geleverd met 4 sleutels per koffers.
- Sterke gelaste pianoscharnier over de volledige lengte van het kofferdeksel.
- Voorzien van 2 vorksheuven voor manipulatie met een vorkheftruck.



EQUIPMENT

Order nr.		758120905 €
Orig. nr.		MWB905
Volume	l	905
Staaldikte	mm	2-5
Gewicht	kg	164,70
Afmetingen (l x b x h)	mm	1140 x 650 x 1270
Prijs	€	885,00



4-delige wielenset voor werfkoffers MWB445, MWB700 en MWB905.
Gemakkelijk transporteren van uw werfkoffer.
Bevestigingsgaten niet voorzien in de koffers.

Order nr.		758120446 €
Orig. nr.		MWB4WS
Gewicht	kg	3,50
Prijs	€	105,00

WERKPLAATSMEUBILAIR

Stel uw eigen werkplaats samen met het werkplaatsmeubilair van HECO. HECO heeft een breed gamma van producten met meer dan 2.000 referenties zoals ladekasten, werkbanken, opbergkasten en wandpanelen om de ideale oplossing te bieden voor de behoeften van onze klanten. We streven ernaar om steeds zo veel mogelijk producten op voorraad te hebben, zodat we de best mogelijke service kunnen bieden. 98% van onze brede waaier van referenties zijn onmiddellijk leverbaar. Er is ook de mogelijkheid om artikelen te produceren volgens de wensen en eisen van de klant: kleuren, maten, prototype, ...



HECO



HECO, PROUD SPONSOR OF THE GP3 CHAMPIONSHIP

Heco opbergkasten

HECO



HE1301



HE1302

OOK IN ANDERE KLEUREN BESCHIKBAAR
 ORIG. NR. MET EXTENSIE GR
 ORIG. NR. MET EXTENSIE RL



• Legplank



HE1303



EHBO-kasten.

Order nr.	761000915 €	761000916 €	761000917 €
Orig. nr.	HE1301	HE1302	HE1303
Aantal inlegborden	1	2	2
Aantal deuren	1	1	2
Gewicht	kg 5,50	8,00	22,00
Afmetingen (l x b x h)	mm 400 x 150 x 450	400 x 150 x 600	800 x 150 x 880
Prijs	€ 214,00	280,00	405,00

HECO

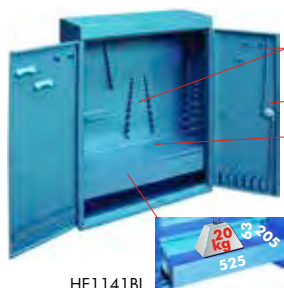

- Gelaste gereedschapshouders
- Slot met sleutel
- Vaste legplank



- Geleverd zonder gereedschappen

HE1141BL

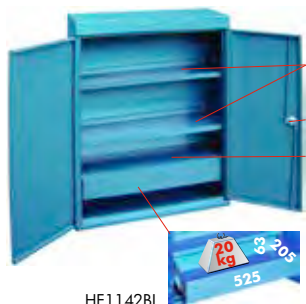

- 2 legplanken, verstelbaar om de 25mm
- Slot met sleutel
- Vaste legplank



OOK IN ANDERE KLEUREN BESCHIKBAAR
 ORIG-NR MET EXTENSIE GR
 ORIG-NR MET EXTENSIE RL

HE1142BL



- 10 V-BULL 1
- Gelaste gereedschapshouders
- 15 V-BULL 2
- Slot met sleutel
- Vaste legplank



- Geleverd zonder gereedschappen

HE114CBL

ACCESSOIRES
 p. 578

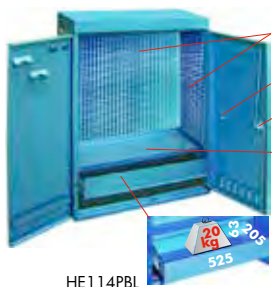

- Geperforeerd paneel tegen de wand en zijkant
- Gelaste gereedschapshouders
- Slot met sleutel
- Vaste legplank

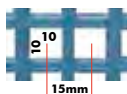

- Geleverd zonder gereedschappen

HE114PBL

Gereedschapskast in zeer stabiele en zware uitvoering geschikt voor intensief en industrieel gebruik. Constructie in plaatstaal 10/10mm met een poederlak coating in lichte hamerslag uitvoering.

- breedte 605mm, hoogte 900mm en diepte 230mm
- verschillende indelingen mogelijk
- capaciteit : tot 118 gereedschappen

Order nr.	Orig. nr.	Gewicht kg	Afmetingen (l x b x h) mm	Prijs €
761000293	HE1141BL	21,00	605 x 230 x 900	310,00
761000294	HE1142BL	25,42	605 x 230 x 900	315,00
761000295	HE114CBL	21,00	605 x 230 x 900	347,00
761000297	HE114PBL	19,00	605 x 230 x 900	303,00



HE1251BL



HE1252BL



EQUIPMENT

OOK IN ANDERE KLEUREN BESCHIKBAAR
 ORIG. NR. MET EXTENSIE GR
 ORIG. NR. MET EXTENSIE RL

Gereedschapskasten in zeer stabiele en zware uitvoering, geschikt voor intensief en industrieel gebruik. Constructie in plaatstaal 10/10mm met een poederlak coating in lichte hamerslag uitvoering.

Order nr.		761000817	761000828
Orig. nr.		HE1251BL	HE1252BL
Gewicht	kg	38,00	47,00
Afmetingen (l x b x h)	mm	513 x 623 x 700	513 x 623 x 1000
Prijs	€	373,00	451,00

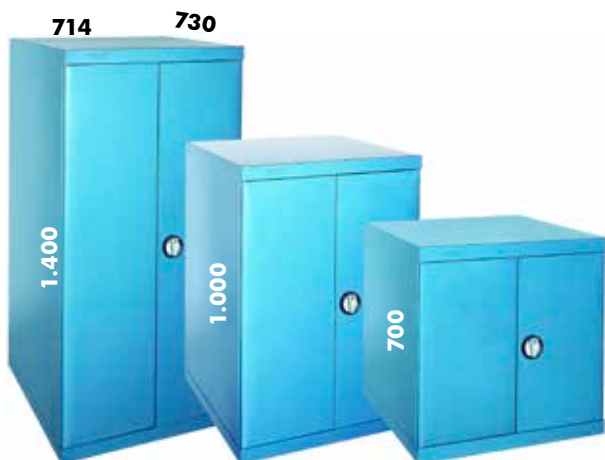

EQUIPMENT

Gereedschapskasten met vleugeldeuren in zeer stabiele en zware uitvoering, geschikt voor intensief en industrieel gebruik. Constructie in plaatstaal 10/10mm met een poederlak coating in lichte hamerslag uitvoering.

- in de hoogte per 25mm verstelbare legborden (cap. 100kg)
- breedte 714mm, diepte 730mm en hoogte 700, 1000 of 1400mm
- centrale vergrendeling met een cilinderslot (+2 sleutels)

Order nr.		761000856	761000863	761000870
Orig. nr.		HE1261BL	HE1262BL	HE1264BL
Gewicht	kg	41,00	49,00	55,00
Afmetingen (l x b x h)	mm	714 x 730 x 700	714 x 730 x 1000	714 x 730 x 1400
Prijs	€	487,00	555,00	685,00

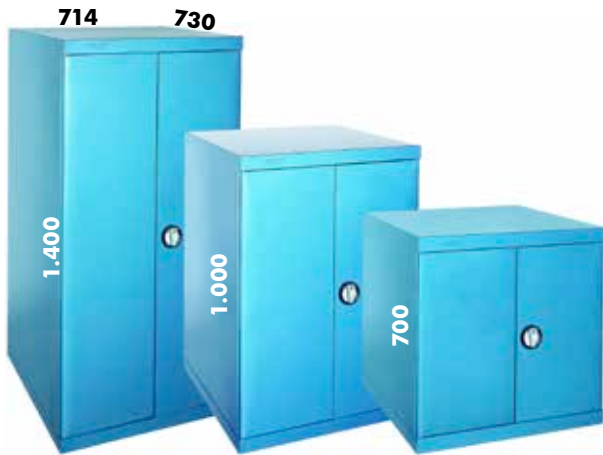

EQUIPMENT



Gereedschapskasten met vleugeldeuren in zeer stabiele en zware uitvoering, geschikt voor intensief en industrieel gebruik. Constructie in plaatstaal 10/10mm met een poederlak coating in lichte hamerslag uitvoering.

- in de hoogte per 25mm verstelbare legborden (cap. 100kg)
- breedte 714, diepte 730mm en hoogte 700, 1000 of 1400mm
- centrale vergrendeling met een cilinderslot (+2 sleutels)
- met uitschuifbare steunen of met cone-houders

Order nr.	Orig. nr.	Gewicht kg	Afmetingen (l x b x h) mm	Prijs €
761000857	HE12611BL	42,50	714 x 730 x 700	525,00
761000858	HE12612BL	51,00	714 x 730 x 700	625,00
761000859	HE12613BL	67,50	714 x 730 x 700	745,00
761000860	HE12614BL	76,00	714 x 730 x 700	829,00
761000861	HE12615BL	65,50	714 x 730 x 700	939,00
761000862	HE12616BL	74,00	714 x 730 x 700	1.039,00
761000864	HE12621BL	52,00	714 x 730 x 1000	615,00
761000865	HE12622BL	69,00	714 x 730 x 1000	835,00
761000866	HE12623BL	100,00	714 x 730 x 1000	995,00
761000867	HE12641BL	84,00	714 x 730 x 1400	885,00
761000868	HE12625BL	82,00	714 x 730 x 1000	1.105,00
761000869	HE12626BL	98,00	714 x 730 x 1000	1.349,00
761000871	HE12641BL	59,50	714 x 730 x 1400	779,00
761000872	HE12642BL	85,00	714 x 730 x 1400	1.069,00
761000873	HE12643BL	108,00	714 x 730 x 1400	1.139,00
761000874	HE12644BL	116,50	714 x 730 x 1400	1.245,00
761000875	HE12645BL	99,50	714 x 730 x 1400	1.499,00
761000876	HE12646BL	108,00	714 x 730 x 1400	1.575,00



HE12611BL



HE12612BL



HE12613BL



HE12614BL



HE12615BL



HE12616BL



HE12621BL



HE12622BL



HE12623BL



HE12624BL



HE12625BL



HE12626BL



HE12641BL



HE12642BL



HE12643BL



HE12644BL



HE12645BL



HE12646BL



Gereedschapskasten in zeer stabiele en zware uitvoering, geschikt voor intensief en industrieel gebruik. Constructie in plaatstaal 10/10mm met een poederlak coating in lichte hamerslag uitvoering.

- laden 90% uittrekbaar met een draagvermogen van 15kg
- in de hoogte per 25mm verstelbare legborden (cap. 100kg)

Order nr.	Orig. nr.	Omschrijving	Gewicht kg	Afmetingen (l x b x h) mm	Prijs €
761001274	HE1544BL	muurkast	35,00	677 x 246 x 913	500,00
761001275	HE15445BL	kast + muurkast	33,50	677 x 400 x 1763	899,00
761001276	HE1545BL	kast	32,00	677 x 400 x 850	388,00



Gereedschapskasten in zeer stabiele en zware uitvoering, geschikt voor intensief en industrieel gebruik. Constructie in plaatstaal 10/10mm met een poederlak coating in lichte hamerslag uitvoering.

- laden 90% uittrekbaar met een draagvermogen van 15kg
- in de hoogte per 25mm verstelbare legborden (cap. 100kg)
- centrale vergrendeling met een cilinderslot (+2 sleutels)
- kunststof beschermingsmat
- deuren met afgeronde hoeken
- met voet of met wielen (2 vaste + 2 draaibare, waarvan 1 met rem)

Order nr.	Orig. nr.	Omschrijving	Gewicht kg	Afmetingen (l x b x h) mm	Prijs €
761001260	HE1540BL	beschermingsmat	64,00	500 x 500 x 1050	599,00
761001261	HE1540PBL	beschermingsmat, voet	65,00	500 x 500 x 1125	669,00
761001262	HE1540RBL	beschermingsmat, nylon wielen	75,00	500 x 500 x 1185	779,00
761001263	HE1541BL	beschermingsmat	35,00	500 x 500 x 1050	339,00
761001265	HE1541PBL	beschermingsmat, voet	36,00	500 x 500 x 1125	399,00
761001266	HE1541RBL	beschermingsmat, nylon wielen	46,00	500 x 500 x 1185	497,00
761001267	HE1542BL	bovenaan openklapbaar	37,00	500 x 500 x 1250	412,00
761001268	HE1542PBL	bovenaan openklapbaar, voet	38,00	500 x 500 x 1325	435,00
761001269	HE1542RBL	bovenaan openklapbaar, nylon wielen	48,00	500 x 500 x 1385	575,00
761001270	HE1543BL	beschermingsmat	50,00	1000 x 500 x 1050	495,00
761001272	HE1543PBL	beschermingsmat, voet	52,00	1000 x 500 x 1125	535,00
761001273	HE1543RBL	beschermingsmat, nylon wielen	63,00	1000 x 500 x 1185	685,00



HE1571BL



HE1572BL



HE1573BL



HE1574BL



HE1575BL



HE1576BL



HE1577BL



HE1578BL

EQUIPMENT

Gereedschapskasten met deuren in zeer stabiele en zware uitvoering, geschikt voor intensief en industrieel gebruik. Constructie in plaatstaal 10/10mm met een poederlak coating in lichte hamerslag uitvoering.

OOK IN ANDERE KLEUREN BESCHIKBAAR
 ORIG-NR MET EXTENSIE GR
 ORIG-NR MET EXTENSIE RL

- laden 100% uittrekbaar met een draagvermogen van 50 kg
- centrale vergrendeling met een cilinderslot (+2 sleutels)

Order nr.	Orig. nr.	Gewicht kg	Afmetingen (l x b x h) mm	Prijs €
761001347	HE1571BL	50,00	500 x 500 x 1980	585,00
761001351	HE1572BL	42,00	500 x 500 x 1980	505,00
761001352	HE1573BL	17,70	500 x 500 x 1980	605,00
761001353	HE1574BL	72,50	500 x 500 x 1980	1.005,00
761001354	HE1575BL	73,00	500 x 500 x 1980	1.105,00
761001355	HE1576BL	80,00	500 x 500 x 1980	745,00
761001356	HE1577BL	45,00	500 x 500 x 1980	865,00
761001357	HE1578BL	70,00	500 x 500 x 1980	805,00
761001358	HE1579BL	52,00	500 x 500 x 1980	1.275,00
761001348	HE15710BL	65,50	500 x 500 x 1980	779,00
761001349	HE15711BL	68,00	500 x 500 x 1980	835,00
761001350	HE15712BL	63,50	500 x 500 x 1980	865,00

HECO



HE157CP
Opbergbakjes.

HE157CG

OOK IN ANDERE KLEUREN BESCHIKBAAR
 ORIG-NR MET EXTENSIE GR
 ORIG-NR MET EXTENSIE RL

Order nr.	761001363 €	761001364 €
Orig. nr.	HE157CG	HE157CP
Gewicht	kg 0,75	0,50
Afmetingen (l x b x h)	mm 180 x 300 x 140	120 x 310 x 110
Prijs	€ 19,50	12,90

HECO



100% UITREKBAAR

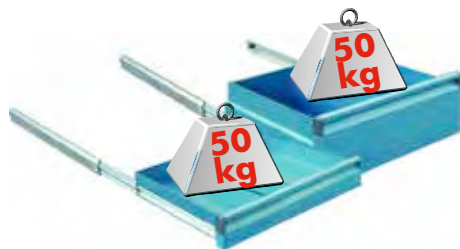

EQUIPMENT

Gereedschapskasten met deuren in zeer stabiele en zware uitvoering, geschikt voor intensief en industrieel gebruik. Constructie in plaatstaal 10/10mm met een poederlak coating in lichte hamerslag uitvoering.

- laden 100% uittrekbaar met een draagvermogen van 50kg
- centrale vergrendeling met een cilinderslot (+2 sleutels)

Order nr.	Orig. nr.	Gewicht kg	Afmetingen (l x b x h) mm	Prijs €
761001372 €	HE1581BL	64,50	700 x 500 x 1980	755,00
761001373 €	HE1582BL	83,50	700 x 500 x 1980	1.215,00
761001374 €	HE1583BL	105,00	700 x 500 x 1980	1.069,00
761001375 €	HE1584BL	87,00	700 x 500 x 1980	959,00
761001376 €	HE1585BL	108,00	700 x 500 x 1980	1.389,00
761001377 €	HE15861BL	81,50	700 x 500 x 1980	1.285,00
761001378 €	HE1587BL	84,00	700 x 500 x 1980	1.025,00
761001379 €	HE1588BL	83,00	700 x 500 x 1980	929,00
761001380 €	HE1589BL	85,00	700 x 500 x 1980	1.069,00



HE1581BL



HE1582BL

H200mm
H200mm
H200mm
H200mm
H200mm



HE1583BL

H200mm
H200mm
H200mm



HE1584BL

H200mm
H200mm



HE1585BL



HE15861BL

H200mm
H200mm

EQUIPMENT

ACCESSOIRES
p. 578



HE1587BL

H100mm
H100mm



HE1588BL

H200mm



HE1589BL

H100mm
H100mm
H200mm



100% UITREKBAAR

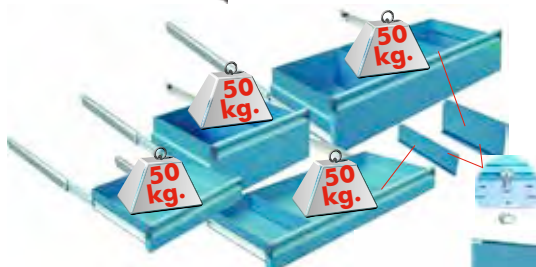

OOK IN ANDERE KLEUREN BESCHIKBAAR
 ORIG-NR MET EXTENSIE GR
 ORIG-NR MET EXTENSIE RL



EQUIPMENT

Gereedschapskasten met deuren in zeer stabiele en zware uitvoering, geschikt voor intensief en industrieel gebruik. Constructie in plaatstaal 10/10mm met een poederlak coating in lichte hamerslag uitvoering.

- laden 100% uittrekbaar met een draagvermogen van 50kg
- centrale vergrendeling met een cilinderslot (+2 sleutels)

Order nr.	Orig. nr.	Gewicht kg	Afmetingen (l x b x h) mm	Prijs €
761001395	HE1591BL	104,00	1000 x 490 x 1980	1.389,00
761001405	HE1592BL	87,50	1000 x 490 x 1980	809,00
761001406	HE1593BL	95,00	1000 x 490 x 1980	1.085,00
761001408	HE1594BL	81,00	1000 x 490 x 1980	885,00
761001409	HE15951BL	91,00	1000 x 490 x 1980	1.369,00
761001410	HE159515BL	91,00	1000 x 490 x 1980	1.339,00
761001411	HE15961BL	91,50	1000 x 490 x 1980	1.275,00
761001412	HE1597BL	90,50	1000 x 490 x 1980	1.069,00
761001413	HE1598BL	116,50	1000 x 490 x 1980	1.419,00
761001414	HE1599BL	120,00	1000 x 490 x 1980	1.645,00
761001396	HE15910BL	95,50	1000 x 490 x 1980	1.175,00
761001397	HE15911BL	106,00	1000 x 490 x 1980	1.135,00
761001398	HE15912BL	118,00	1000 x 490 x 1980	1.485,00
761001399	HE15913BL	112,00	1000 x 490 x 1980	1.369,00
761001400	HE15914BL	122,50	1000 x 490 x 1980	1.599,00
761001401	HE15915BL	144,50	1000 x 490 x 1980	1.805,00
761001402	HE15916BL	110,00	1000 x 490 x 1980	1.165,00
761001403	HE15917BL	110,00	1000 x 490 x 1980	1.165,00
761001404	HE15918BL	110,00	1000 x 490 x 1980	1.165,00



HE1591BL

H200mm
H200mm
H200mm
H200mm
H200mm



HE1592BL



HE1593BL

H200mm



HE1594BL



HE15951BL HE159515BL

H200mm



HE15961BL

H200mm
H200mm



HE1597BL



HE1598BL

H200mm



HE1599BL



HE1599CPBL



HE1599CGBL



HE15910BL

H100mm
H100mm
H200mm



HE15911BL

H100mm
H100mm



HE15912BL

H100mm
H100mm
H200mm
H200mm
H200mm
H200mm



HE15913BL

H100mm
H200mm



HE15914BL

H100mm
H200mm



HE15915BL

H100mm
H200mm



HE15916BL

H200mm



HE15917BL

H200mm



HE15918BL

H200mm

EQUIPMENT



HE159B1



HE159B2



HE159B3



HE159B4



HE159B5



HE159B6



HE159B7

Gereedschapskasten met deuren in zeer stabiele en zware uitvoering, geschikt voor intensief en industrieel gebruik. Constructie in plaatstaal 10/10mm met een poederlak coating in lichte hamerslag uitvoering.

- laden 100% uittrekbaar met een draagvermogen van 50kg
- centrale vergrendeling met een cilinderslot (+2 sleutels)

Order nr.	Orig. nr.	Omschrijving	Gewicht kg	Afmetingen (l x b x h) mm	Prijs €
761001416	HE159B1BL	met 2 legborden	41,50	1000 x 490 x 1000	595,00
761001417	HE159B2BL	met 2 laden	55,50	1000 x 490 x 1000	885,00
761001418	HE159B3BL	met 1 lade	51,50	1000 x 490 x 1000	809,00
761001419	HE159B4BL	met 24 bakjes	53,50	1000 x 490 x 1000	899,00
761001420	HE159B5BL	met 3 laden	63,00	1000 x 490 x 1000	1.049,00
761001421	HE159B6BL	met 1 lade	48,00	1000 x 490 x 1000	779,00
761001422	HE159B7BL	met 6 laden	73,00	1000 x 490 x 1000	1.249,00
761001423	HE159B8BL	met 5 laden	71,50	1000 x 490 x 1000	1.155,00
761001424	HE159B9BL	met 3 laden	60,50	1000 x 490 x 1000	959,00

HECO



OOK IN ANDERE KLEUREN BESCHIKBAAR
 ORIG. NR. MET EXTENSIE GR
 ORIG. NR. MET EXTENSIE RL



Toepassing

Hoekkast zonder legbord voor kasten 157/158/159C.

Order nr.		761001436 €
Orig. nr.		HE159CABL
Gewicht	kg	102,00
Afmetingen (l x b x h)	mm	625 x 490 x 1980
Prijs	€	1.105,00

HECO



Stootbaar voor kasten HE159.

Order nr.		761001451 €
Orig. nr.		HE159TCBL
Gewicht	kg	0,01
Prijs	€	15,90

HECO



Legbord voor hoekkast HE159CA.

Order nr.		761001437 €
Orig. nr.		HE159CABBL
Gewicht	kg	7,00
Prijs	€	64,50



HE157C1BL



HE157C2BL



HE157C3BL



HE157CBL



HE157C4BL



HE157C5BL



HE157C6BL

Gereedschapskasten met deuren in zeer stabiele en zware uitvoering, geschikt voor intensief en industrieel gebruik. Constructie in plaatstaal 10/10mm met een poederlak coating in lichte hamerslag uitvoering. Met geperforeerde achterwand voor montage van plastic bakjes.

- voorzien van bakjes, behalve HE157C
- centrale vergrendeling met een cilinderslot (+2 sleutels)

Order nr.	Orig. nr.	Omschrijving	Gewicht kg	Afmetingen (l x b x h)		Prijs €
				mm		
761001361	HE157CBL	zonder bakjes	32,00	500	x 260 x 1980	482,00
761001362	HE157C1BL	24x0,4 l + 16x1,2 l + 12x3,5 l	46,00	500	x 260 x 1980	579,00
761002074	HE157C2BL	20x0,4 l + 36x1,2 l + 6x3,5 l	46,50	500	x 260 x 1980	605,00
761002075	HE157C3BL	12x0,4 l + 40x1,2 l + 6x3,5 l	46,50	500	x 260 x 1980	605,00
761002076	HE157C4BL	100x0,4 l	45,00	500	x 260 x 1980	579,00
761002077	HE157C5BL	52x1,2 l	46,00	500	x 260 x 1980	595,00
761002078	HE157C6BL	27x3,5 l	46,50	500	x 260 x 1980	605,00

HECO



OOK IN ANDERE KLEUREN BESCHIKBAAR
 ORIG. NR. MET EXTENSIE GR
 ORIG. NR. MET EXTENSIE RL



HE158CBL



HE158C1BL



HE158C2BL



HE158C3BL



HE158C4BL



HE158C5BL



HE158C6BL

Gereedschapskasten met deuren in zeer stabiele en zware uitvoering, geschikt voor intensief en industrieel gebruik. Constructie in plaatstaal 10/10mm met een poederlak coating in lichte hamerslag uitvoering. Met geperforeerde achterwand voor montage van plastic bakjes.

- voorzien van bakjes, behalve HE158C
- centrale vergrendeling met een cilinderslot (+2 sleutels)

Order nr.	Orig. nr.	Omschrijving	Gewicht kg	Afmetingen (l x b x h) mm	Prijs €
761001383	HE158CBL	zonder bakjes	56,00	700 x 260 x 1980	585,00
761001384	HE158C1BL	36x0,4 l + 24x1,2 l + 16x3,5 l	58,00	700 x 260 x 1980	719,00
761002080	HE158C2BL	30x0,4 l + 54x1,2 l + 8x3,5 l	59,50	700 x 260 x 1980	679,00
761002081	HE158C3BL	18x0,4 l + 60x1,2 l + 8x3,5 l	59,50	700 x 260 x 1980	685,00
761002082	HE158C4BL	150x0,4 l	57,00	700 x 260 x 1980	659,00
761002083	HE158C5BL	78x1,2 l	59,00	700 x 260 x 1980	669,00
761002084	HE158C6BL	36x3,5 l	58,50	700 x 260 x 1980	669,00

EQUIPMENT

HECO



HE159CBL



HE159C1BL



HE159C2BL



HE159C3BL



HE159C4BL



HE159C5BL



HE159C6BL

EQUIPMENT

Gereedschapskasten met deuren in zeer stabiele en zware uitvoering, geschikt voor intensief en industrieel gebruik. Constructie in plaatstaal 10/10mm met een poederlak coating in lichte hamerslag uitvoering.

- voorzien van bakjes, behalve HE159C
- centrale vergrendeling met een cilinderslot (+2 sleutels)

Order nr.	Orig. nr.	Omschrijving	Gewicht kg	Afmetingen (l x b x h) mm	Prijs €
761001429	HE159CBL	zonder bakjes	70,00	1000 x 260 x 1980	679,00
761001430	HE159C1BL	54x0,4 l + 36x1,2 l + 24x3,5 l	82,00	1000 x 260 x 1980	849,00
761001431	HE159C2BL	45x0,4 l + 81x1,2 l + 12x3,5 l	84,00	1000 x 260 x 1980	875,00
761001432	HE159C3BL	27x0,4 l + 90x1,2 l + 12x3,5 l	84,00	1000 x 260 x 1980	875,00
761001433	HE159C4BL	225x0,4 l	81,00	1000 x 260 x 1980	829,00
761001434	HE159C5BL	117x1,2 l	83,00	1000 x 260 x 1980	855,00
761001435	HE159C6BL	54x3,5 l	82,50	1000 x 260 x 1980	855,00

HECO

500



HE159P1BL

1980

OOK IN ANDERE KLEUREN BESCHIKBAAR

ORIG. NR. MET EXTENSIE GR
ORIG. NR. MET EXTENSIE RL



HE159P2BL



HE159P3BL



HE159P4BL

ACCESSOIRES

p. 578



HE159P5BL



HE159P6BL

500



HE159PB1BL

1000

Gereedschapskasten in zeer stabiele en zware uitvoering, geschikt voor intensief en industrieel gebruik. Constructie in plaatstaal 10/10mm met een poederlak coating in lichte hamerslag uitvoering.

- laden 100% uittrekbaar met een draagvermogen van 50kg

Order nr.	Orig. nr.	Gewicht kg	Afmetingen (l x b x h) mm	Prijs €
761002089	HE159P1BL	116,00	1005 x 500 x 1980	1.595,00
761002090	HE159P2BL	119,00	1005 x 500 x 1980	1.675,00
761002091	HE159P3BL	101,00	1005 x 500 x 1980	1.095,00
761002092	HE159P4BL	111,00	1005 x 500 x 1980	1.419,00
761002093	HE159P5BL	114,00	1005 x 500 x 1980	1.199,00
761002094	HE159P6BL	112,00	1005 x 500 x 1980	1.309,00
761002096	HE159PB1BL	67,00	1005 x 500 x 1000	1.029,00
761002097	HE159PB2BL	64,00	1005 x 500 x 1000	935,00
761002098	HE159PB3BL	52,00	1005 x 500 x 1000	739,00



Vestiaire kasten in zeer stabiele en zware uitvoering, geschikt voor intensief en industrieel gebruik. Constructie in plaatstaal 10/10mm met een poederlak coating in lichte hamerslag uitvoering.

- type HE155 400mm breed, type HE156 300mm breed

Order nr.	Orig. nr.	Gewicht kg	Prijs €
761001309	HE15611BL	28,00	283,00
761001279	HE15511BL	30,00	307,00
761001314	HE15612BL	25,00	255,00
761001284	HE15512BL	27,00	280,00
761001310	HE156112BL	53,00	525,00
761001280	HE155112BL	57,00	585,00
761001311	HE156113BL	81,00	769,00
761001281	HE155113BL	91,50	829,00
761001312	HE156114BL	111,00	1.015,00
761001282	HE155114BL	122,00	1.115,00
761001313	HE156115BL	141,00	1.265,00
761001283	HE155115BL	154,00	1.379,00
761001315	HE15621BL	29,00	327,00
761001285	HE15521BL	31,00	354,00
761001320	HE15622BL	26,00	299,00
761001290	HE15522BL	28,00	327,00
761001316	HE156212BL	55,00	615,00
761001286	HE155212BL	59,00	689,00
761001317	HE156213BL	89,00	929,00
761001287	HE155213BL	94,50	1.015,00
761001318	HE156214BL	115,00	1.225,00
761001288	HE155214BL	126,00	1.339,00
761001319	HE156215BL	146,00	1.489,00
761001289	HE155215BL	159,00	1.609,00
761001321	HE1562P1BL	30,30	322,00
761001291	HE1552P1BL	32,00	348,00
761001326	HE1562P2BL	27,30	276,00
761001296	HE1552P2BL	29,00	321,00
761001322	HE1562P12BL	57,60	605,00
761001292	HE1552P12BL	61,00	679,00
761001323	HE1562P13BL	84,90	915,00
761001293	HE1552P13BL	90,90	1.005,00
761001324	HE1562P14BL	111,20	1.199,00
761001294	HE1552P14BL	123,70	1.319,00
761001325	HE1562P15BL	138,50	1.469,00
761001295	HE1552P15BL	141,50	1.575,00
761001327	HE15631BL	30,00	398,00
761001297	HE15531BL	31,00	422,00
761001332	HE15632BL	27,00	369,00
761001302	HE15532BL	28,00	390,00
761001328	HE156312BL	57,00	779,00
761001298	HE155312BL	59,00	835,00
761001329	HE156313BL	87,00	1.085,00
761001299	HE155313BL	94,50	1.165,00
761001330	HE156314BL	119,00	1.399,00
761001300	HE155314BL	126,00	1.509,00
761001331	HE156315BL	151,00	1.785,00
761001301	HE155315BL	159,00	1.885,00
761001333	HE15641BL	30,00	387,00
761001303	HE15541BL	33,00	417,00
761001338	HE15642BL	30,00	361,00
761001308	HE15542BL	30,00	390,00
761001334	HE156412BL	57,00	759,00
761001304	HE155412BL	63,00	825,00
761001335	HE156413BL	87,00	1.059,00
761001305	HE155413BL	101,00	1.155,00
761001336	HE156414BL	119,00	1.369,00
761001306	HE155414BL	134,00	1.489,00
761001337	HE156415BL	151,00	1.739,00
761001307	HE155415BL	169,00	1.895,00

EQUIPMENT

OOK IN ANDERE KLEUREN BESCHIKBAAR
 ORIG-NR MET EXTENSIE GR
 ORIG-NR MET EXTENSIE RL

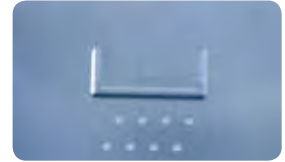

• Etikettenhouders



• Deuren geperforeerd voor verluchting binnenin. 180° openen mogelijk door afgeronde hoeken

• Legbord met baar voor kleeerhangers



• Versterkte deuren

EQUIPMENT



HE15611BL
HE15511BL



HE15612BL
HE15512BL

1 DEUR



HE156112BL
HE155112BL



HE156113BL
HE155113BL



HE156114BL
HE155114BL



HE156115BL
HE155115BL



HE15621BL
HE15521BL



HE15622BL
HE15522BL

2 DEUREN



HE156212BL
HE155212BL



HE156213BL
HE155213BL



HE156214BL
HE155214BL



HE156215BL
HE155215BL

EQUIPMENT

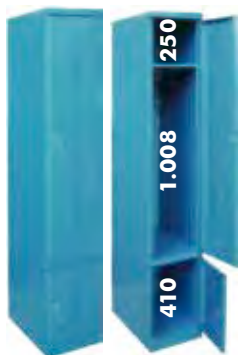

HE1562P1BL
HE1552P1BL



HE1562P2BL
HE1552P2BL

2 DEUREN



HE1562P12BL
HE1552P12BL



HE1562P13BL
HE1552P13BL



HE1562P14BL
HE1552P14BL



HE1562P15BL
HE1552P15BL

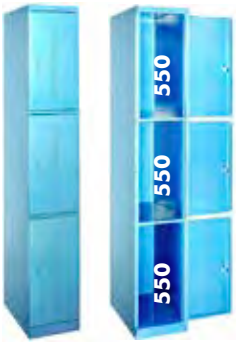

HE15631BL
HE15531BL



HE15632BL
HE15532BL

3 DEUREN



HE156312BL
HE155312BL



HE156313BL
HE155313BL



HE156314BL
HE155314BL



HE156315BL
HE155315BL

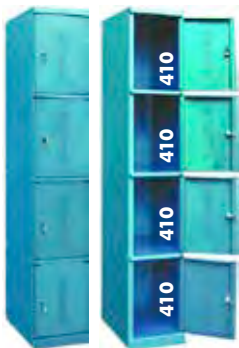

HE15641BL
HE15541BL



HE15642BL
HE15542BL

4 DEUREN



HE156412BL
HE155412BL



HE156413BL
HE155413BL



HE156414BL
HE155414BL



HE156415BL
HE155415BL

EQUIPMENT



HE156BV10



HE156BV15



HE156BV20

Locker bank.

Order nr.	761001339 €	761001340 €	761001341 €
Orig. nr.	HE156BV10BL	HE156BV15BL	HE156BV20BL
Gewicht	kg 11,00	19,00	23,00
Afmetingen (l x b x h)	mm 900 x 320 x 480	1500 x 320 x 480	2000 x 320 x 480
Prijs	€ 198,00	318,00	396,00



OOK IN ANDERE KLEUREN BESCHIKBAAR
 ORIG. NR. MET EXTENSIE GR
 ORIG. NR. MET EXTENSIE RL

Vestiaire kasten in zeer stabiele en zware uitvoering, geschikt voor intensief en industrieel gebruik. Constructie in plaatstaal 10/10mm met een poederlak coating in lichte hamerslag uitvoering. Met afgeschuind dak.

Order nr.	Orig. nr.	Aantal deuren	Gewicht kg	Afmetingen (l x b x h) mm	Prijs €
761001458 €	HE1608TIBL	8	71,00	800 x 500 x 1890	1.135,00
761002106 €	HE160102TIBL	10	76,00	800 x 500 x 1890	1.225,00
761001454 €	HE160122TIBL	12	76,00	800 x 500 x 1890	1.275,00
761002105 €	HE160101TIBL	10	54,00	500 x 500 x 1890	875,00
761001453 €	HE160121TIBL	12	54,00	500 x 500 x 1890	919,00
761002107 €	HE160161TIBL	16	74,00	500 x 500 x 2375	1.275,00



Vestiaire kasten in zeer stabiele en zware uitvoering, geschikt voor intensief en industrieel gebruik. Constructie in plaatstaal 10/10mm met een poederlak coating in lichte hamerslag uitvoering. Met afgeschuind dak en klep om kleding in de kast te gooien.

Order nr.	Orig. nr.	Gewicht kg	Afmetingen (l x b x h) mm	Prijs €
761001452 €	HE1600BL	28,50	400 x 500 x 1890	348,00
761001455 €	HE1601TIBL	58,00	800 x 900 x 2280	709,00

HECO



NEW

Computerkast met rolgordijn.

Order nr.		761040055 €
Orig. nr.		HE110W001BL
Type		computerkast
Gewicht	kg	40,00
Prijs	€	429,00

HECO



NEW

HE103 1BL



PC-kast - HE103 2BL



PC-kast - HE103 3BL



PC-kast - HE103 4BL

Mobiele en modulaire computerkasten.

Ideaal voor werkstations op de werkvloer, waar computers beschermd worden van stof en vuil.

Verschillende modules mogelijk:

- 4 grote wielen ø 100mm, waarvan 2 geremd.
- Afgesloten kasten met plexi front voor zowel pc onderaan als flatscreen 23" bovenaan
- Stroomvoorziening met stroomstekkerdoos, ventilator en LAN-stekker

Order nr.		761013567 €	761013568 €	761013569 €	761013570 €
Orig. nr.		HE1031BL	HE1032BL	HE1033BL	HE1034BL
Gewicht	kg	1,00	1,00	1,00	1,00
Afmetingen (l x b x h)	mm	895 x 860 x 1735	895 x 860 x 1735	895 x 860 x 1735	895 x 860 x 1735
Prijs	€	865,00	845,00	709,00	462,00

LADEKASTEN

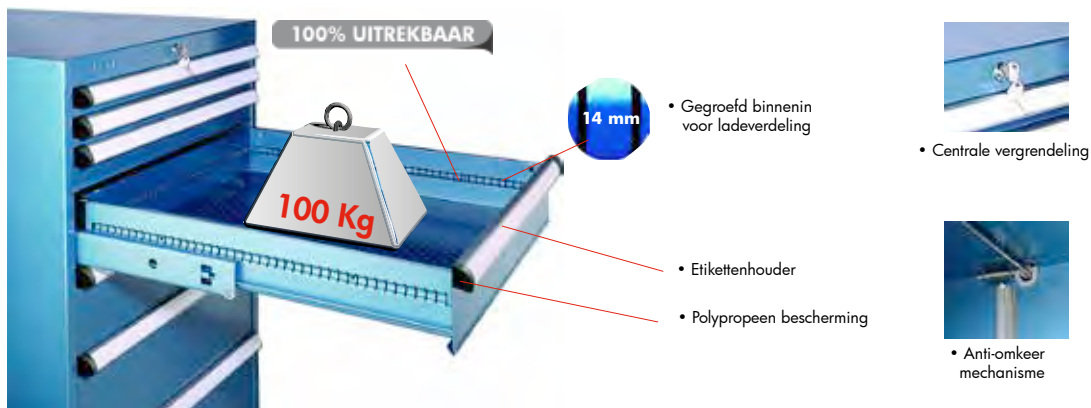

• Zeer goede inzicht op de lade inhoud

OOK IN ANDERE KLEUREN BESCHIKBAAR
ORIG NR MET EXTENSIE GR
ORIG NR MET EXTENSIE RL

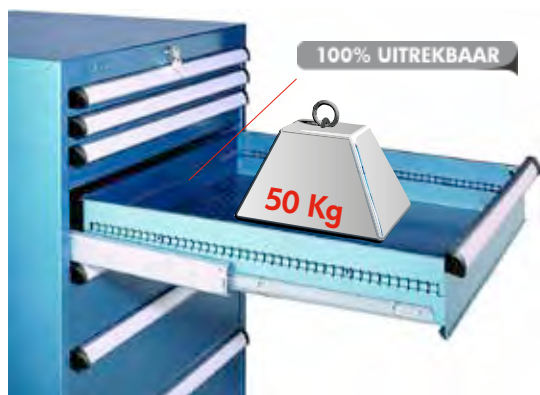
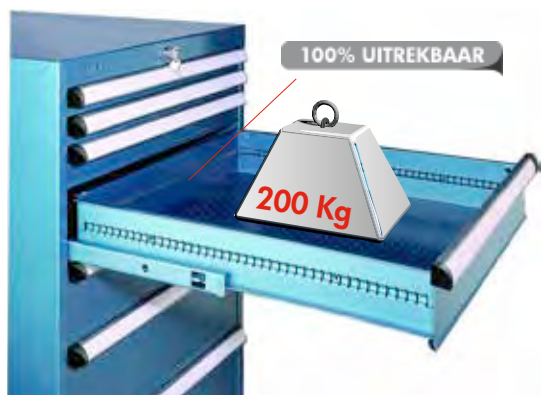

HECO



700x714mm



1400x1020mm



1000x714mm



700x600mm



1400x714mm



1000x600mm



700x1020mm



1400x600mm



1000x1020mm

Heco ladekasten



Ladenkasten in zeer stabiele en zware uitvoering, geschikt voor intensief en industrieel gebruik. Constructie in plaatstaal 10/10mm (kast) en 15/10mm (laden)..

- breedte 714mm, en hoogte 700mm
- centrale vergrendeling met een cilinderslot (+2 sleutels)
- zeer hoogwaardige lagergeleidingen
- 1-lade uittrekbeveiliging voorkomt omkantelen
- verschillende compartimenten en lade-indelingen mogelijk
- Diepte 707mm of 600mm mogelijk
- Afwerking: blauwe poederlak coating in lichte hamerslag uitvoering



Verskillende mogelijke laden:

- Laden 100% uittrekbaar met een draagvermogen van 50kg
- Laden 90% uittrekbaar met een draagvermogen van 100kg - Zelfsluitend
- Laden 100% uittrekbaar met een draagvermogen van 100kg
- Laden 100% uittrekbaar met een draagvermogen van 200kg

Optie: Meerdere kasten kunnen op aanvraag met lopersleutel worden geleverd.

Order nr.	Orig. nr.	Uittrekbaar %	Zelfsluitend	Capaciteit lades kg	Aantal laden	Gewicht kg	Afmetingen (l x b x h) mm	Prijs €
761000322	HE115101BL	100		50	3	70,50	714 x 707 x 700	935,00
761000323	HE115102BL	100		50	4	77,00	714 x 707 x 700	1.059,00
761000324	HE115103BL	100		50	4	76,00	714 x 707 x 700	1.059,00
761000325	HE115104BL	100		50	4	74,00	714 x 707 x 700	1.059,00
761000326	HE115105BL	100		50	4	75,00	714 x 707 x 700	1.059,00
761000327	HE115106BL	100		50	5	80,00	714 x 707 x 700	1.185,00
761000328	HE115107BL	100		50	5	79,00	714 x 707 x 700	1.189,00
761000329	HE115108BL	100		50	6	84,00	714 x 707 x 700	1.319,00
761000330	HE115109BL	100		50	8	90,00	714 x 707 x 700	1.555,00
761000331	HE115111BL	90	✓	100	3	81,50	714 x 707 x 700	925,00
761000332	HE115112BL	90	✓	100	4	89,00	714 x 707 x 700	1.039,00
761000333	HE115113BL	90	✓	100	4	92,00	714 x 707 x 700	1.049,00
761000334	HE115114BL	90	✓	100	4	87,00	714 x 707 x 700	1.029,00
761000335	HE115115BL	90	✓	100	4	89,50	714 x 707 x 700	1.039,00
761000336	HE115116BL	90	✓	100	5	96,00	714 x 707 x 700	1.149,00
761000337	HE115117BL	90	✓	100	5	96,00	714 x 707 x 700	1.155,00
761000338	HE115118BL	90	✓	100	6	105,00	714 x 707 x 700	1.275,00
761000339	HE115119BL	90	✓	100	8	102,00	714 x 707 x 700	1.479,00
761000340	HE115121BL	100		100	3	85,50	714 x 707 x 700	1.049,00
761000341	HE115122BL	100		100	4	96,00	714 x 707 x 700	1.215,00
761000342	HE115123BL	100		100	4	96,00	714 x 707 x 700	1.215,00
761000343	HE115124BL	100		100	4	95,00	714 x 707 x 700	1.199,00
761000344	HE115125BL	100		100	5	103,50	714 x 707 x 700	1.349,00
761000352	HE115126BL	100		100	5	104,50	714 x 707 x 700	1.359,00
761000353	HE115127BL	100		100	5	105,50	714 x 707 x 700	1.359,00
761000354	HE115128BL	100		100	6	117,00	714 x 707 x 700	1.525,00
761000355	HE115129BL	100		100	8	130,00	714 x 707 x 700	1.795,00
761000356	HE115131BL	100		200	3	100,00	714 x 707 x 700	1.079,00
761000357	HE115132BL	100		200	4	113,00	714 x 707 x 700	1.255,00
761000358	HE115133BL	100		200	4	114,00	714 x 707 x 700	1.259,00
761000359	HE115134BL	100		200	4	112,00	714 x 707 x 700	1.245,00
761000360	HE115135BL	100		200	4	112,50	714 x 707 x 700	1.255,00
761000361	HE115136BL	100		200	5	125,50	714 x 707 x 700	1.419,00
761000362	HE115137BL	100		200	5	125,50	714 x 707 x 700	1.429,00
761000363	HE115138BL	100		200	6	138,00	714 x 707 x 700	1.575,00
761000364	HE115139BL	100		200	8	162,00	714 x 707 x 700	1.895,00
761001950	HE122111BL	90		100	3	54,50	714 x 600 x 700	829,00
761001951	HE122112BL	90		100	4	61,00	714 x 600 x 700	929,00
761001952	HE122113BL	90		100	4	61,00	714 x 600 x 700	939,00
761001953	HE122114BL	90		100	4	61,00	714 x 600 x 700	929,00
761001954	HE122115BL	90		100	4	61,00	714 x 600 x 700	935,00
761001955	HE122116BL	90		100	5	67,00	714 x 600 x 700	1.039,00
761001956	HE122117BL	90		100	5	67,00	714 x 600 x 700	1.039,00
761001957	HE122118BL	90		100	6	73,00	714 x 600 x 700	1.135,00
761001958	HE122119BL	90		100	8	85,00	714 x 600 x 700	1.329,00

3 laden



H150mm
H200mm
H250mm

HE115101 - HE115111
HE115121 - HE115131
HE122111

4 laden



H100mm
H100mm
H200mm
H200mm

HE115102 - HE115112
HE115122 - HE115132
HE122112

4 laden



H150mm
H150mm
H150mm
H150mm

HE115103 - HE115113
HE115123 - HE115133
HE122113

4 laden



H75mm
H75mm
H200mm
H250mm

HE115104 - HE115114
HE115124 - HE115134
HE122114

4 laden



H100mm
H100mm
H150mm
H250mm

HE115105 - HE115115
HE115125 - HE115135
HE122115

5 laden



H75mm
H75mm
H100mm
H150mm
H200mm

HE115106 - HE115116
HE115126 - HE115136
HE122116

5 laden



H75mm
H100mm
H100mm
H125mm
H200mm

HE115107 - HE115117
HE115127 - HE115137
HE122117

6 laden



H100mm
H100mm
H100mm
H100mm
H100mm
H100mm

HE115108 - HE115118
HE115128 - HE115138
HE122118

8 laden



H75mm
H75mm
H75mm
H75mm
H75mm
H75mm
H75mm
H75mm

HE115109 - HE115119
HE115129 - HE115139
HE122119

EQUIPMENT

OOK IN ANDERE KLEUREN BESCHIKBAAR
ORIG- NR MET EXTENSIE GR
ORIG- NR MET EXTENSIE RL

ONDERVERDELINGEN
p. 558

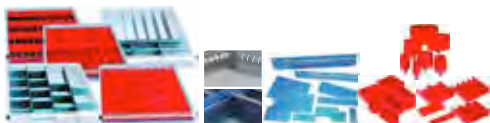



Ladenkasten in zeer stabiele en zware uitvoering, geschikt voor intensief en industrieel gebruik. Constructie in plaatstaal 10/10mm (kast) en 15/10mm (laden)..

- breedte 714mm, en hoogte 700mm
- centrale vergrendeling met een cilinderslot (+2 sleutels)
- zeer hoogwaardige lagergeleidingen
- 1-lade uittrekbeveiliging voorkomt omkantelen
- verschillende compartimenten en lade-indelingen mogelijk
- Diepte 707mm of 600mm mogelijk
- Afwerking: rode poederlak coating in lichte hamerslag uitvoering



Verskillende mogelijke laden:

- Laden 100% uittrekbaar met een draagvermogen van 50kg
- Laden 90% uittrekbaar met een draagvermogen van 100kg - Zelfsluitend
- Laden 100% uittrekbaar met een draagvermogen van 100kg
- Laden 100% uittrekbaar met een draagvermogen van 200kg

Optie: Meerdere kasten kunnen op aanvraag met lopersleutel worden geleverd.

Order nr.	Orig. nr.	Uittrekbaar		Capaciteit lades	Aantal laden	Gewicht	Afmetingen (l x b x h)	Prijs
		%	Zelfsluitend					
761020322	HE115101RE	100		50	3	70,50	714 x 707 x 700	935,00
761020323	HE115102RE	100		50	4	77,00	714 x 707 x 700	1.059,00
761020324	HE115103RE	100		50	4	76,00	714 x 707 x 700	1.059,00
761020325	HE115104RE	100		50	4	74,00	714 x 707 x 700	1.059,00
761020326	HE115105RE	100		50	4	75,00	714 x 707 x 700	1.059,00
761020327	HE115106RE	100		50	5	80,00	714 x 707 x 700	1.185,00
761020328	HE115107RE	100		50	5	79,00	714 x 707 x 700	1.189,00
761020329	HE115108RE	100		50	6	84,00	714 x 707 x 700	1.319,00
761020330	HE115109RE	100		50	8	90,00	714 x 707 x 700	1.555,00
761003585	HE115111RE	90	✓	100	3	81,50	714 x 707 x 700	925,00
761003586	HE115112RE	90	✓	100	4	89,00	714 x 707 x 700	1.039,00
761003587	HE115113RE	90	✓	100	4	92,00	714 x 707 x 700	1.049,00
761003588	HE115114RE	90	✓	100	4	87,00	714 x 707 x 700	1.029,00
761003589	HE115115RE	90	✓	100	4	89,50	714 x 707 x 700	1.039,00
761003590	HE115116RE	90	✓	100	5	96,00	714 x 707 x 700	1.149,00
761003591	HE115117RE	90	✓	100	5	96,00	714 x 707 x 700	1.155,00
761003592	HE115118RE	90	✓	100	6	105,00	714 x 707 x 700	1.275,00
761003593	HE115119RE	90	✓	100	8	102,00	714 x 707 x 700	1.479,00
761020340	HE115121RE	100		100	3	85,50	714 x 707 x 700	1.049,00
761020341	HE115122RE	100		100	4	96,00	714 x 707 x 700	1.215,00
761020342	HE115123RE	100		100	4	96,00	714 x 707 x 700	1.215,00
761020343	HE115124RE	100		100	4	95,00	714 x 707 x 700	1.199,00
761020344	HE115125RE	100		100	5	103,50	714 x 707 x 700	1.349,00
761020352	HE115126RE	100		100	-	104,50	714 x 707 x 700	1.359,00
761020353	HE115127RE	100		100	5	105,50	714 x 707 x 700	1.359,00
761020354	HE115128RE	100		100	6	117,00	714 x 707 x 700	1.525,00
761020355	HE115129RE	100		100	8	130,00	714 x 707 x 700	1.795,00
761020356	HE115131RE	100		200	3	100,00	714 x 707 x 700	1.079,00
761020357	HE115132RE	100		200	4	113,00	714 x 707 x 700	1.255,00
761020358	HE115133RE	100		200	4	114,00	714 x 707 x 700	1.259,00
761020359	HE115134RE	100		200	4	112,00	714 x 707 x 700	1.245,00
761020360	HE115135RE	100		200	4	112,50	714 x 707 x 700	1.255,00
761020361	HE115136RE	100		200	5	125,50	714 x 707 x 700	1.419,00
761020362	HE115137RE	100		200	5	125,50	714 x 707 x 700	1.429,00
761020363	HE115138RE	100		200	6	138,00	714 x 707 x 700	1.575,00
761020364	HE115139RE	100		200	8	162,00	714 x 707 x 700	1.895,00
761021950	HE122111RE	90		100	3	54,50	714 x 600 x 700	829,00
761021951	HE122112RE	90		100	4	61,00	714 x 600 x 700	929,00
761021952	HE122113RE	90		100	4	61,00	714 x 600 x 700	939,00
761021953	HE122114RE	90		100	4	61,00	714 x 600 x 700	929,00
761021954	HE122115RE	90		100	4	61,00	714 x 600 x 700	935,00
761021955	HE122116RE	90		100	4	67,00	714 x 600 x 700	1.039,00
761021956	HE122117RE	90		100	5	67,00	714 x 600 x 700	1.039,00
761021957	HE122118RE	90		100	5	73,00	714 x 600 x 700	1.135,00
761021958	HE122119RE	90		100	6	85,00	714 x 600 x 700	1.329,00



Ladenkasten in zeer stabiele en zware uitvoering, geschikt voor intensief en industrieel gebruik. Constructie in plaatstaal 10/10mm (kast) en 15/10mm (laden)..

- breedte 714mm, en hoogte 700mm
- centrale vergrendeling met een cilinderslot (+2 sleutels)
- zeer hoogwaardige lagergeleidingen
- 1-lade uittrekbeveiliging voorkomt omkantelen
- verschillende compartimenten en lade-indelingen mogelijk
- Diepte 707mm of 600mm mogelijk
- Afwerking: Grijsz poederlak coating in lichte hamerslag uitvoering

INFO
p. 529



Verschillende mogelijke laden:

- Laden 100% uittrekbaar met een draagvermogen van 50kg
- Laden 90% uittrekbaar met een draagvermogen van 100kg - Zelfsluitend
- Laden 100% uittrekbaar met een draagvermogen van 100kg
- Laden 100% uittrekbaar met een draagvermogen van 200kg

Optie: Meerdere kasten kunnen op aanvraag met lopersleutel worden geleverd.

Order nr.	Orig. nr.	Uittrekbaar	Zelfsluitend		Capaciteit lades	Aantal laden	Gewicht	Afmetingen (l x b x h)	Prijs
			%	kg					
761010322	HE115101GR	100	✓	50	3	70,50	714 x 707 x 700	935,00	
761010323	HE115102GR	100	✓	50	4	77,00	714 x 707 x 700	1.059,00	
761010324	HE115103GR	100	✓	50	4	76,00	714 x 707 x 700	1.059,00	
761010325	HE115104GR	100	✓	50	4	74,00	714 x 707 x 700	1.059,00	
761010326	HE115105GR	100	✓	50	4	75,00	714 x 707 x 700	1.059,00	
761010327	HE115106GR	100	✓	50	5	80,00	714 x 707 x 700	1.185,00	
761010329	HE115108GR	100	✓	50	6	84,00	714 x 707 x 700	1.319,00	
761010328	HE115107GR	100	✓	50	5	79,00	714 x 707 x 700	1.189,00	
761010330	HE115109GR	100	✓	50	8	90,00	714 x 707 x 700	1.555,00	
761003567	HE115111GR	90	✓	100	3	81,50	714 x 707 x 700	925,00	
761003568	HE115112GR	90	✓	100	4	89,00	714 x 707 x 700	1.039,00	
761003569	HE115113GR	90	✓	100	4	92,00	714 x 707 x 700	1.049,00	
761003570	HE115114GR	90	✓	100	4	87,00	714 x 707 x 700	1.029,00	
761003571	HE115115GR	90	✓	100	4	89,50	714 x 707 x 700	1.039,00	
761021964	HE115116GR	90	✓	100	5	96,00	714 x 707 x 700	1.149,00	
761021965	HE115117GR	90	✓	100	5	96,00	714 x 707 x 700	1.155,00	
761021966	HE115118GR	90	✓	100	6	105,00	714 x 707 x 700	1.275,00	
761021967	HE115119GR	90	✓	100	8	102,00	714 x 707 x 700	1.479,00	
761010340	HE115121GR	100	✓	100	3	85,50	714 x 707 x 700	1.049,00	
761010341	HE115122GR	100	✓	100	4	96,00	714 x 707 x 700	1.215,00	
761010342	HE115123GR	100	✓	100	4	96,00	714 x 707 x 700	1.215,00	
761010343	HE115124GR	100	✓	100	4	95,00	714 x 707 x 700	1.199,00	
761010344	HE115125GR	100	✓	100	5	103,50	714 x 707 x 700	1.349,00	
761010352	HE115126GR	100	✓	100	-	104,50	714 x 707 x 700	1.359,00	
761010353	HE115127GR	100	✓	100	5	105,50	714 x 707 x 700	1.359,00	
761010354	HE115128GR	100	✓	100	6	117,00	714 x 707 x 700	1.525,00	
761010355	HE115129GR	100	✓	100	8	130,00	714 x 707 x 700	1.795,00	
761010356	HE115131GR	100	✓	200	3	100,00	714 x 707 x 700	1.079,00	
761010357	HE115132GR	100	✓	200	4	113,00	714 x 707 x 700	1.255,00	
761010358	HE115133GR	100	✓	200	4	114,00	714 x 707 x 700	1.259,00	
761010359	HE115134GR	100	✓	200	4	112,00	714 x 707 x 700	1.245,00	
761010360	HE115135GR	100	✓	200	4	112,50	714 x 707 x 700	1.255,00	
761010361	HE115136GR	100	✓	200	5	125,50	714 x 707 x 700	1.419,00	
761010362	HE115137GR	100	✓	200	5	125,50	714 x 707 x 700	1.429,00	
761010363	HE115138GR	100	✓	200	6	138,00	714 x 707 x 700	1.575,00	
761010364	HE115139GR	100	✓	200	8	162,00	714 x 707 x 700	1.895,00	
761011954	HE122115GR	90	✓	100	4	61,00	714 x 600 x 700	935,00	
761011955	HE122116GR	90	✓	100	5	67,00	714 x 600 x 700	1.039,00	
761011956	HE122117GR	90	✓	100	5	67,00	714 x 600 x 700	1.039,00	
761011957	HE122118GR	90	✓	100	6	73,00	714 x 600 x 700	1.135,00	
761011958	HE122119GR	90	✓	100	8	85,00	714 x 600 x 700	1.329,00	

EQUIPMENT



Ladenkasten in zeer stabiele en zware uitvoering, geschikt voor intensief en industrieel gebruik. Constructie in plaatstaal 10/10mm (kast) en 15/10mm (laden)..

- breedte 714mm, en hoogte 1000mm
- centrale vergrendeling met een cilinderslot (+2 sleutels)
- zeer hoogwaardige lagergeleidingen
- 1-lade uittrekbeveiliging voorkomt omkantelen
- verschillende compartimenten en lade-indelingen mogelijk
- Diepte 707mm of 600mm mogelijk
- Afwerking: blauwe poederlak coating in lichte hamerslag uitvoering

Verschillende mogelijke laden:

- Laden 100% uittrekbaar met een draagvermogen van 50kg
- Laden 90% uittrekbaar met een draagvermogen van 100kg - Zelfsluitend
- Laden 100% uittrekbaar met een draagvermogen van 100kg
- Laden 100% uittrekbaar met een draagvermogen van 200kg

Optie: Meerdere kasten kunnen op aanvraag met lopersleutel worden geleverd.

Order nr.	Orig. nr.	Uittrekbaar		Capaciteit lades	Aantal laden	Gewicht	Afmetingen (l x b x h)	Prijs
		Zelfsluitend	%					
761000380	HE115201BL		100	50	5	94,00	714 x 707 x 1000	1.309,00
761000381	HE115202BL		100	50	6	98,00	714 x 707 x 1000	1.439,00
761000382	HE115203BL		100	50	6	100,00	714 x 707 x 1000	1.439,00
761000383	HE115204BL		100	50	7	101,50	714 x 707 x 1000	1.545,00
761000384	HE115205BL		100	50	8	107,00	714 x 707 x 1000	1.669,00
761000385	HE115206BL		100	50	9	111,00	714 x 707 x 1000	1.795,00
761000386	HE115207BL		100	50	9	112,00	714 x 707 x 1000	1.795,00
761000387	HE115208BL		100	50	11	118,00	714 x 707 x 1000	2.039,00
761000388	HE115209BL		100	50	12	121,00	714 x 707 x 1000	2.175,00
761000389	HE115211BL		90	100	5	111,50	714 x 707 x 1000	1.285,00
761000390	HE115212BL	✓	90	100	6	119,00	714 x 707 x 1000	1.399,00
761000391	HE115213BL	✓	90	100	6	124,00	714 x 707 x 1000	1.399,00
761000392	HE115214BL	✓	90	100	7	124,50	714 x 707 x 1000	1.505,00
761000393	HE115215BL	✓	90	100	8	135,00	714 x 707 x 1000	1.609,00
761000394	HE115216BL	✓	90	100	9	141,50	714 x 707 x 1000	1.715,00
761000395	HE115217BL	✓	90	100	9	143,50	714 x 707 x 1000	1.719,00
761000396	HE115218BL	✓	90	100	11	152,50	714 x 707 x 1000	1.925,00
761000397	HE115219BL	✓	90	100	12	157,00	714 x 707 x 1000	2.025,00
761000398	HE115221BL		100	100	6	128,50	714 x 707 x 1000	1.619,00
761000399	HE115222BL		100	100	6	130,00	714 x 707 x 1000	1.635,00
761000400	HE115223BL		100	100	7	137,50	714 x 707 x 1000	1.775,00
761000401	HE115224BL		100	100	8	148,00	714 x 707 x 1000	1.925,00
761000402	HE115225BL		100	100	9	157,50	714 x 707 x 1000	2.079,00
761000403	HE115226BL		100	100	9	158,50	714 x 707 x 1000	2.089,00
761000404	HE115227BL		100	100	9	161,50	714 x 707 x 1000	2.099,00
761000405	HE115228BL		100	100	12	173,50	714 x 707 x 1000	2.519,00
761000406	HE115229BL		100	100	12	181,00	714 x 707 x 1000	2.529,00
761000407	HE115231BL		100	200	6	143,00	714 x 707 x 1000	1.525,00
761000408	HE115232BL		100	200	6	155,00	714 x 707 x 1000	1.695,00
761000409	HE115233BL		100	200	6	172,00	714 x 707 x 1000	1.699,00
761000410	HE115234BL		100	200	7	167,00	714 x 707 x 1000	1.859,00
761000411	HE115235BL		100	200	8	181,00	714 x 707 x 1000	2.029,00
761000412	HE115236BL		100	200	9	193,00	714 x 707 x 1000	2.195,00
761000413	HE115237BL		100	200	9	193,00	714 x 707 x 1000	2.199,00
761000414	HE115238BL		100	200	11	217,00	714 x 707 x 1000	2.519,00
761000415	HE115239BL		100	200	12	229,00	714 x 707 x 1000	2.669,00
761000745	HE1122211BL		90	100	5	84,50	714 x 600 x 1000	1.149,00
761000746	HE1122212BL		90	100	6	91,00	714 x 600 x 1000	1.255,00
761000747	HE1122213BL		90	100	6	91,00	714 x 600 x 1000	1.265,00
761000748	HE1122214BL		90	100	7	97,00	714 x 600 x 1000	1.349,00
761000749	HE1122215BL		90	100	8	103,00	714 x 600 x 1000	1.459,00
761000750	HE1122216BL		90	100	9	109,00	714 x 600 x 1000	1.535,00
761000751	HE1122217BL		90	100	9	109,00	714 x 600 x 1000	1.525,00
761000752	HE1122218BL		90	100	11	121,00	714 x 600 x 1000	1.719,00
761000753	HE1122219BL		90	100	12	127,00	714 x 600 x 1000	1.825,00

5 laden



HE115201 - HE115211
HE115231 - HE122211

6 laden



HE115202 - HE115212
HE115212 - HE115232
HE122212

6 laden



HE115203 - HE115213
HE115222 - HE115233
HE122213

7 laden



HE115204 - HE115214
HE115223 - HE115234
HE122214

8 laden



HE115224

8 laden



HE115205 - HE115215
HE115235 - HE122215

9 laden



HE115206 - HE115216
HE115226 - HE115236
HE122216

9 laden



HE115225

9 laden



HE115207 - HE115217
HE115227 - HE115237
HE122217

11 laden



HE115208 - HE115218
HE115238 - HE122218

12 laden



HE115209 - HE115219
HE115229 - HE115239
HE122219

12 laden



HE115228

OOK IN ANDERE KLEUREN BESCHIKBAAR
ORIG- NR MET EXTENSIE GR
ORIG- NR MET EXTENSIE RL

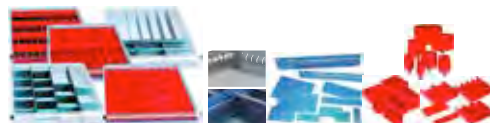

ONDERVERDELINGEN
p. 558

EQUIPMENT



Ladenkasten in zeer stabiele en zware uitvoering, geschikt voor intensief en industrieel gebruik. Constructie in plaatstaal 10/10mm (kast) en 15/10mm (laden)..

- breedte 714mm, en hoogte 1000mm
- centrale vergrendeling met een cilinderslot (+2 sleutels)
- zeer hoogwaardige lagergeleidingen
- 1-lade uittrekbeveiliging voorkomt omkantelen
- verschillende compartimenten en lade-indelingen mogelijk
- Diepte 707mm of 600mm mogelijk
- Afwerking: rode poederlak coating in lichte hamerslag uitvoering



Verskillende mogelijke laden:

- Laden 100% uittrekbaar met een draagvermogen van 50kg
- Laden 90% uittrekbaar met een draagvermogen van 100kg - Zelfsluitend
- Laden 100% uittrekbaar met een draagvermogen van 100kg
- Laden 100% uittrekbaar met een draagvermogen van 200kg

Optie: Meerdere kasten kunnen op aanvraag met lopersleutel worden geleverd.

Order nr.	Orig. nr.	Uittrekbaar %	Zelfsluitend	Capaciteit lades kg	Aantal laden	Gewicht kg	Afmetingen (l x b x h) mm	Prijs €
761020380	HE115201RE	100		50	6	94,00	714 x 707 x 1000	1.309,00
761020381	HE115202RE	100		50	6	98,00	714 x 707 x 1000	1.439,00
761020382	HE115203RE	100		50	6	100,00	714 x 707 x 1000	1.439,00
761020383	HE115204RE	100		50	7	101,50	714 x 707 x 1000	1.545,00
761020384	HE115205RE	100		50	8	107,00	714 x 707 x 1000	1.669,00
761020385	HE115206RE	100		50	9	111,00	714 x 707 x 1000	1.795,00
761020386	HE115207RE	100		50	9	112,00	714 x 707 x 1000	1.795,00
761020387	HE115208RE	100		50	11	118,00	714 x 707 x 1000	2.039,00
761020388	HE115209RE	100		50	12	121,00	714 x 707 x 1000	2.175,00
761003594	HE115211RE	90	✓	100	6	111,50	714 x 707 x 1000	1.285,00
761003595	HE115212RE	90	✓	100	6	119,00	714 x 707 x 1000	1.399,00
761003596	HE115213RE	90	✓	100	6	124,00	714 x 707 x 1000	1.399,00
761003597	HE115214RE	90	✓	100	7	124,50	714 x 707 x 1000	1.505,00
761003598	HE115215RE	90	✓	100	8	135,00	714 x 707 x 1000	1.609,00
761003599	HE115216RE	90	✓	100	9	141,50	714 x 707 x 1000	1.715,00
761003600	HE115217RE	90	✓	100	9	143,50	714 x 707 x 1000	1.719,00
761003601	HE115218RE	90	✓	100	11	152,50	714 x 707 x 1000	1.925,00
761003602	HE115219RE	90	✓	100	12	157,00	714 x 707 x 1000	2.025,00
761020398	HE115221RE	100		100	6	128,50	714 x 707 x 1000	1.619,00
761020399	HE115222RE	100		100	6	130,00	714 x 707 x 1000	1.635,00
761020400	HE115223RE	100		100	7	137,50	714 x 707 x 1000	1.775,00
761020401	HE115224RE	100		100	8	148,00	714 x 707 x 1000	1.925,00
761020402	HE115225RE	100		100	9	157,50	714 x 707 x 1000	2.079,00
761020403	HE115226RE	100		100	9	158,50	714 x 707 x 1000	2.089,00
761020404	HE115227RE	100		100	9	161,50	714 x 707 x 1000	2.099,00
761020405	HE115228RE	100		100	12	173,50	714 x 707 x 1000	2.519,00
761020406	HE115229RE	100		100	12	181,00	714 x 707 x 1000	2.529,00
761020407	HE115231RE	100		200	6	143,00	714 x 707 x 1000	1.525,00
761020408	HE115232RE	100		200	6	155,00	714 x 707 x 1000	1.695,00
761020409	HE115233RE	100		200	6	172,00	714 x 707 x 1000	1.699,00
761020410	HE115234RE	100		200	7	167,00	714 x 707 x 1000	1.859,00
761020411	HE115235RE	100		200	8	181,00	714 x 707 x 1000	2.029,00
761020412	HE115236RE	100		200	9	193,00	714 x 707 x 1000	2.195,00
761020413	HE115237RE	100		200	9	193,00	714 x 707 x 1000	2.199,00
761020414	HE115238RE	100		200	11	217,00	714 x 707 x 1000	2.519,00
761020415	HE115239RE	100		200	12	229,00	714 x 707 x 1000	2.669,00
761020745	HE122211RE	90		100	5	84,50	714 x 600 x 1000	1.149,00
761020746	HE122212RE	90		100	6	91,00	714 x 600 x 1000	1.255,00
761020747	HE122213RE	90		100	6	91,00	714 x 600 x 1000	1.265,00
761020748	HE122214RE	90		100	7	97,00	714 x 600 x 1000	1.349,00
761020749	HE122215RE	90		100	8	103,00	714 x 600 x 1000	1.459,00
761020750	HE122216RE	90		100	9	109,00	714 x 600 x 1000	1.535,00
761020751	HE122217RE	90		100	9	109,00	714 x 600 x 1000	1.525,00
761020752	HE122218RE	90		100	11	121,00	714 x 600 x 1000	1.719,00
761020753	HE122219RE	90		100	12	127,00	714 x 600 x 1000	1.825,00

EQUIPMENT



Ladenkasten in zeer stabiele en zware uitvoering, geschikt voor intensief en industrieel gebruik. Constructie in plaatstaal 10/10mm (kast) en 15/10mm (laden)..

- breedte 714mm, en hoogte 1000mm
- centrale vergrendeling met een cilinderslot (+2 sleutels)
- zeer hoogwaardige lagergeleidingen
- 1-lade uittrekbeveiliging voorkomt omkantelen
- verschillende compartimenten en lade-indelingen mogelijk
- Diepte 707mm of 600mm mogelijk
- Afwerking: grijze poederlak coating in lichte hamerslag uitvoering

INFO
p. 533



Verschillende mogelijke laden:

- Laden 100% uittrekbaar met een draagvermogen van 50kg
- Laden 90% uittrekbaar met een draagvermogen van 100kg - Zelfsluitend
- Laden 100% uittrekbaar met een draagvermogen van 100kg
- Laden 100% uittrekbaar met een draagvermogen van 200kg

Optie: Meerdere kasten kunnen op aanvraag met lopersleutel worden geleverd.

Order nr.	Orig. nr.	Uittrekbaar	Zelfsluitend	Capaciteit lades	Aantal laden	Gewicht	Afmetingen (l x b x h)	Prijs
								€
		%		kg		kg	mm	
761010380	HE115201GR	100		50	6	94,00	714 x 707 x 1000	1.309,00
761010381	HE115202GR	100		50	6	98,00	714 x 707 x 1000	1.439,00
761010382	HE115203GR	100		50	6	100,00	714 x 707 x 1000	1.439,00
761010383	HE115204GR	100		50	7	101,50	714 x 707 x 1000	1.545,00
761010384	HE115205GR	100		50	8	107,00	714 x 707 x 1000	1.669,00
761010385	HE115206GR	100		50	9	111,00	714 x 707 x 1000	1.795,00
761010386	HE115207GR	100		50	9	112,00	714 x 707 x 1000	1.795,00
761010387	HE115208GR	100		50	11	118,00	714 x 707 x 1000	2.039,00
761010388	HE115209GR	100		50	12	121,00	714 x 707 x 1000	2.175,00
761010407	HE115231GR	100		200	6	143,00	714 x 707 x 1000	1.525,00
761010408	HE115232GR	100		200	6	155,00	714 x 707 x 1000	1.695,00
761010409	HE115233GR	100		200	6	172,00	714 x 707 x 1000	1.699,00
761010410	HE115234GR	100		200	7	167,00	714 x 707 x 1000	1.859,00
761010411	HE115235GR	100		200	8	181,00	714 x 707 x 1000	2.029,00
761010412	HE115236GR	100		200	9	193,00	714 x 707 x 1000	2.195,00
761010413	HE115237GR	100		200	9	193,00	714 x 707 x 1000	2.199,00
761010414	HE115238GR	100		200	11	217,00	714 x 707 x 1000	2.519,00
761010415	HE115239GR	100		200	12	229,00	714 x 707 x 1000	2.669,00
761010398	HE115221GR	100		100	6	128,50	714 x 707 x 1000	1.619,00
761010399	HE115222GR	100		100	6	130,00	714 x 707 x 1000	1.635,00
761010400	HE115223GR	100		100	7	137,50	714 x 707 x 1000	1.775,00
761010401	HE115224GR	100		100	8	148,00	714 x 707 x 1000	1.925,00
761010402	HE115225GR	100		100	9	157,50	714 x 707 x 1000	2.079,00
761010403	HE115226GR	100		100	9	158,50	714 x 707 x 1000	2.089,00
761010404	HE115227GR	100		100	9	161,50	714 x 707 x 1000	2.099,00
761010405	HE115228GR	100		100	12	173,50	714 x 707 x 1000	2.519,00
761010406	HE115229GR	100		100	12	181,00	714 x 707 x 1000	2.529,00
761021968	HE115211GR	90	✓	100	6	111,50	714 x 707 x 1000	1.285,00
761021969	HE115212GR	90	✓	100	6	119,00	714 x 707 x 1000	1.399,00
761021970	HE115213GR	90	✓	100	6	124,00	714 x 707 x 1000	1.399,00
761021971	HE115214GR	90	✓	100	7	124,50	714 x 707 x 1000	1.505,00
761021972	HE115215GR	90	✓	100	8	135,00	714 x 707 x 1000	1.609,00
761003572	HE115216GR	90	✓	100	9	141,50	714 x 707 x 1000	1.715,00
761003573	HE115217GR	90	✓	100	9	143,50	714 x 707 x 1000	1.719,00
761003574	HE115218GR	90	✓	100	11	152,50	714 x 707 x 1000	1.925,00
761003575	HE115219GR	90	✓	100	12	157,00	714 x 707 x 1000	2.025,00
761010745	HE122211GR	90		100	5	84,50	714 x 600 x 1000	1.149,00
761010746	HE122212GR	90		100	6	91,00	714 x 600 x 1000	1.255,00
761010747	HE122213GR	90		100	6	91,00	714 x 600 x 1000	1.265,00
761010748	HE122214GR	90		100	7	97,00	714 x 600 x 1000	1.349,00
761010749	HE122215GR	90		100	8	103,00	714 x 600 x 1000	1.459,00
761010750	HE122216GR	90		100	9	109,00	714 x 600 x 1000	1.535,00
761010751	HE122217GR	90		100	9	109,00	714 x 600 x 1000	1.525,00
761010752	HE122218GR	90		100	11	121,00	714 x 600 x 1000	1.719,00
761010753	HE122219GR	90		100	12	127,00	714 x 600 x 1000	1.825,00

EQUIPMENT



Ladenkasten in zeer stabiele en zware uitvoering, geschikt voor intensief en industrieel gebruik. Constructie in plaatstaal 10/10mm (kast) en 15/10mm (laden)..

- breedte 714mm, en hoogte 1400mm
- centrale vergrendeling met een cilinderslot (+2 sleutels)
- zeer hoogwaardige lagergeleidingen
- 1-lade uittrekbeveiliging voorkomt omkantelen
- verschillende compartimenten en lade-indelingen mogelijk
- Diepte 707mm of 600mm mogelijk
- Afwerking: blauwe poederlak coating in lichte hamerslag uitvoering

Verschillende mogelijke laden:

- Laden 100% uittrekbaar met een draagvermogen van 50kg
- Laden 90% uittrekbaar met een draagvermogen van 100kg - Zelfsluitend
- Laden 100% uittrekbaar met een draagvermogen van 100kg
- Laden 100% uittrekbaar met een draagvermogen van 200kg

Optie: Meerdere kasten kunnen op aanvraag met lopersleutel worden geleverd.

Order nr.	Orig. nr.	Uittrekbaar		Capaciteit lades	Aantal lades	Gewicht kg	Afmetingen (l x b x h) mm	Prijs €
		Zelfsluitend	%					
761000423	HE115401BL		100	50	7	120,00	714 x 707 x 1400	1.685,00
761000424	HE115402BL		100	50	7	120,50	714 x 707 x 1400	1.685,00
761000425	HE115403BL		100	50	8	124,00	714 x 707 x 1400	1.809,00
761000426	HE115404BL		100	50	8	123,50	714 x 707 x 1400	1.815,00
761000427	HE115405BL		100	50	10	131,50	714 x 707 x 1400	2.069,00
761000428	HE115406BL		100	50	10	132,50	714 x 707 x 1400	2.069,00
761000429	HE115407BL		100	50	11	134,50	714 x 707 x 1400	2.185,00
761000430	HE115408BL		100	50	12	139,50	714 x 707 x 1400	2.325,00
761000431	HE115409BL		100	50	13	147,00	714 x 707 x 1400	2.445,00
761000432	HE115411BL	✓	90	100	7	144,50	714 x 707 x 1400	1.665,00
761000433	HE115412BL	✓	90	100	7	146,00	714 x 707 x 1400	1.665,00
761000434	HE115413BL	✓	90	100	8	152,00	714 x 707 x 1400	1.769,00
761000435	HE115414BL	✓	90	100	8	151,00	714 x 707 x 1400	1.769,00
761000436	HE115415BL	✓	90	100	10	164,00	714 x 707 x 1400	1.989,00
761000437	HE115416BL	✓	90	100	10	167,00	714 x 707 x 1400	1.999,00
761000438	HE115417BL	✓	90	100	11	169,00	714 x 707 x 1400	2.089,00
761000439	HE115418BL	✓	90	100	12	178,00	714 x 707 x 1400	2.215,00
761000440	HE115419BL	✓	90	100	13	192,00	714 x 707 x 1400	2.345,00
761000441	HE115421BL		100	100	8	166,00	714 x 707 x 1400	2.099,00
761000442	HE115422BL		100	100	8	165,00	714 x 707 x 1400	2.099,00
761000443	HE115423BL		100	100	10	184,00	714 x 707 x 1400	2.389,00
761000444	HE115424BL		100	100	10	185,00	714 x 707 x 1400	2.409,00
761000445	HE115425BL		100	100	11	192,50	714 x 707 x 1400	2.545,00
761000446	HE115426BL		100	100	11	189,50	714 x 707 x 1400	2.539,00
761000447	HE115427BL		100	100	12	202,00	714 x 707 x 1400	2.679,00
761000448	HE115428BL		100	100	12	195,00	714 x 707 x 1400	2.705,00
761000449	HE115429BL		100	100	13	218,50	714 x 707 x 1400	2.875,00
761000450	HE115431BL		100	200	7	189,00	714 x 707 x 1400	2.019,00
761000451	HE115432BL		100	200	7	185,50	714 x 707 x 1400	2.019,00
761000452	HE115433BL		100	200	8	201,00	714 x 707 x 1400	2.185,00
761000453	HE115434BL		100	200	8	200,00	714 x 707 x 1400	2.185,00
761000454	HE115435BL		100	200	10	225,50	714 x 707 x 1400	2.519,00
761000455	HE115436BL		100	200	10	226,00	714 x 707 x 1400	2.525,00
761000456	HE115437BL		100	200	11	236,50	714 x 707 x 1400	2.669,00
761000457	HE115438BL		100	200	12	250,50	714 x 707 x 1400	2.855,00
761000458	HE115439BL		100	200	13	264,00	714 x 707 x 1400	3.029,00
761000757	HE122411BL		90	100	7	114,00	714 x 600 x 1400	1.499,00
761000758	HE122412BL		90	100	7	114,00	714 x 600 x 1400	1.499,00
761000759	HE122413BL		90	100	8	120,00	714 x 600 x 1400	1.575,00
761000760	HE122414BL		90	100	8	121,00	714 x 600 x 1400	1.575,00
761000761	HE122415BL		90	100	10	132,00	714 x 600 x 1400	1.779,00
761000762	HE122416BL		90	100	10	126,00	714 x 600 x 1400	1.779,00
761000763	HE122417BL		90	100	11	138,00	714 x 600 x 1400	1.869,00
761000764	HE122418BL		90	100	12	118,50	714 x 600 x 1400	1.979,00
761000765	HE122419BL		90	100	13	150,00	714 x 600 x 1400	2.069,00

EQUIPMENT

7 laden



HE115401 - HE115411
HE115431 - HE122411

7 laden



HE115402 - HE115412
HE115432 - HE122412

8 laden



HE115403 - HE115413
HE115421 - HE115433
HE122413

8 laden



HE115404 - HE115414
HE115422 - HE115434
HE122414

10 laden



HE115405 - HE115415
HE115435 - HE122415

10 laden



HE115406 - HE115416
HE115424 - HE115436
HE122416

10 laden



HE115423

11 laden



HE115425

11 laden



HE115407 - HE115417
HE115426 - HE115437
HE122417

12 laden



HE115408 - HE115418
HE115428 - HE115438
HE122418

12 laden



HE115427

13 laden



HE115409 - HE115419
HE115429 - HE115439B
HE122419

OOK IN ANDERE KLEUREN BESCHIKBAAR

ORIG. NR. MET EXTENSIE GR
ORIG. NR. MET EXTENSIE RL

ONDERVERDELINGEN

p. 558

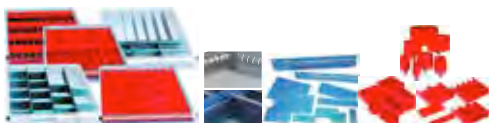



Ladenkasten in zeer stabiele en zware uitvoering, geschikt voor intensief en industrieel gebruik. Constructie in plaatstaal 10/10mm (kast) en 15/10mm (laden)..

- breedte 714mm, en hoogte 1400mm
- centrale vergrendeling met een cilinderslot (+2 sleutels)
- zeer hoogwaardige lagergeleidingen
- 1-lade uittrekbeveiliging voorkomt omkantelen
- verschillende compartimenten en lade-indelingen mogelijk
- Diepte 707mm of 600mm mogelijk
- Afwerking: rode poederlak coating in lichte hamerslag uitvoering

INFO
p. 537



Verskillende mogelijke laden:

- Laden 100% uittrekbaar met een draagvermogen van 50kg
- Laden 90% uittrekbaar met een draagvermogen van 100kg - Zelfsluitend
- Laden 100% uittrekbaar met een draagvermogen van 100kg
- Laden 100% uittrekbaar met een draagvermogen van 200kg

Optie: Meerdere kasten kunnen op aanvraag met lopersleutel worden geleverd.

Order nr.	Orig. nr.	Uittrekbaar		Capaciteit laden	Aantal laden	Gewicht kg	Afmetingen (l x b x h) mm	Prijs €
		Zelfsluitend	%					
761020423	HE115401RE		100	50	7	120,00	714 x 707 x 1400	1.685,00
761020424	HE115402RE		100	50	7	120,50	714 x 707 x 1400	1.685,00
761020425	HE115403RE		100	50	8	124,00	714 x 707 x 1400	1.809,00
761020426	HE115404RE		100	50	8	123,50	714 x 707 x 1400	1.815,00
761020427	HE115405RE		100	50	10	131,50	714 x 707 x 1400	2.069,00
761020428	HE115406RE		100	50	10	132,50	714 x 707 x 1400	2.069,00
761020429	HE115407RE		100	50	11	134,50	714 x 707 x 1400	2.185,00
761020430	HE115408RE		100	50	12	139,50	714 x 707 x 1400	2.325,00
761020431	HE115409RE		100	50	13	147,00	714 x 707 x 1400	2.445,00
761003603	HE115411RE	✓	90	100	7	144,50	714 x 707 x 1400	1.665,00
761003604	HE115412RE	✓	90	100	7	146,00	714 x 707 x 1400	1.665,00
761003605	HE115413RE	✓	90	100	8	152,00	714 x 707 x 1400	1.769,00
761003606	HE115414RE	✓	90	100	8	151,00	714 x 707 x 1400	1.769,00
761003607	HE115415RE	✓	90	100	10	164,00	714 x 707 x 1400	1.989,00
761003608	HE115416RE	✓	90	100	10	167,00	714 x 707 x 1400	1.999,00
761003609	HE115417RE	✓	90	100	11	169,00	714 x 707 x 1400	2.089,00
761003610	HE115418RE	✓	90	100	12	178,00	714 x 707 x 1400	2.215,00
761003611	HE115419RE	✓	90	100	13	192,00	714 x 707 x 1400	2.345,00
761020441	HE115421RE		100	100	8	166,00	714 x 707 x 1400	2.099,00
761020442	HE115422RE		100	100	8	165,00	714 x 707 x 1400	2.099,00
761020443	HE115423RE		100	100	10	184,00	714 x 707 x 1400	2.389,00
761020444	HE115424RE		100	100	10	185,00	714 x 707 x 1400	2.409,00
761020445	HE115425RE		100	100	11	192,50	714 x 707 x 1400	2.545,00
761020446	HE115426RE		100	100	11	189,50	714 x 707 x 1400	2.539,00
761020447	HE115427RE		100	100	12	202,00	714 x 707 x 1400	2.679,00
761020448	HE115428RE		100	100	12	195,00	714 x 707 x 1400	2.705,00
761020449	HE115429RE		100	100	13	218,50	714 x 707 x 1400	2.875,00
761020450	HE115431RE		100	200	7	189,00	714 x 707 x 1400	2.019,00
761020451	HE115432RE		100	200	7	185,50	714 x 707 x 1400	2.019,00
761020452	HE115433RE		100	200	8	201,00	714 x 707 x 1400	2.185,00
761020453	HE115434RE		100	200	8	200,00	714 x 707 x 1400	2.185,00
761020454	HE115435RE		100	200	10	225,50	714 x 707 x 1400	2.519,00
761020455	HE115436RE		100	200	10	226,00	714 x 707 x 1400	2.525,00
761020456	HE115437RE		100	200	11	236,50	714 x 707 x 1400	2.669,00
761020457	HE115438RE		100	200	12	250,50	714 x 707 x 1400	2.855,00
761020458	HE115439RE		100	200	13	264,00	714 x 707 x 1400	3.029,00
761020757	HE122411RE		90	100	7	114,00	714 x 600 x 1400	1.499,00
761020758	HE122412RE		90	100	7	114,00	714 x 600 x 1400	1.499,00
761020759	HE122413RE		90	100	8	120,00	714 x 600 x 1400	1.575,00
761020760	HE122414RE		90	100	8	121,00	714 x 600 x 1400	1.575,00
761020761	HE122415RE		90	100	10	132,00	714 x 600 x 1400	1.779,00
761020762	HE122416RE		90	100	10	126,00	714 x 600 x 1400	1.779,00
761020763	HE122417RE		90	100	11	138,00	714 x 600 x 1400	1.869,00
761020764	HE122418RE		90	100	12	118,50	714 x 600 x 1400	1.979,00
761020765	HE122419RE		90	100	13	150,00	714 x 600 x 1400	2.069,00



Ladenkasten in zeer stabiele en zware uitvoering, geschikt voor intensief en industrieel gebruik. Constructie in plaatstaal 10/10mm (kast) en 15/10mm (laden)..

- breedte 714mm, en hoogte 1400mm
- centrale vergrendeling met een cilinderslot (+2 sleutels)
- zeer hoogwaardige lagergeleidingen
- 1-lade uittrekbeveiliging voorkomt omkantelen
- verschillende compartimenten en lade-indelingen mogelijk
- Diepte 707mm of 600mm mogelijk
- Afwerking: grijze poederlak coating in lichte hamerslag uitvoering

INFO
p. 537



Verschillende mogelijke laden:

- Laden 100% uittrekbaar met een draagvermogen van 50kg
- Laden 90% uittrekbaar met een draagvermogen van 100kg - Zelfsluitend
- Laden 100% uittrekbaar met een draagvermogen van 100kg
- Laden 100% uittrekbaar met een draagvermogen van 200kg

Optie: Meerdere kasten kunnen op aanvraag met lopersleutel worden geleverd.

Order nr.	Orig. nr.	Uittrekbaar %	Zelfsluitend	Capaciteit lades kg	Aantal lades	Gewicht kg	Afmetingen (l x b x h)		Prijs €
							mm	mm	
761010423	HE115401GR	100		50	7	120,00	714 x 707 x 1400	1.685,00	
761010424	HE115402GR	100		50	7	120,50	714 x 707 x 1400	1.685,00	
761010425	HE115403GR	100		50	8	124,00	714 x 707 x 1400	1.809,00	
761010426	HE115404GR	100		50	8	123,50	714 x 707 x 1400	1.815,00	
761010427	HE115405GR	100		50	10	131,50	714 x 707 x 1400	2.069,00	
761010428	HE115406GR	100		50	10	132,50	714 x 707 x 1400	2.069,00	
761010429	HE115407GR	100		50	11	134,50	714 x 707 x 1400	2.185,00	
761010430	HE115408GR	100		50	12	139,50	714 x 707 x 1400	2.325,00	
761010431	HE115409GR	100		50	13	147,00	714 x 707 x 1400	2.445,00	
761010450	HE115431GR	100		200	7	189,00	714 x 707 x 1400	2.019,00	
761010451	HE115432GR	100		200	7	185,50	714 x 707 x 1400	2.019,00	
761010452	HE115433GR	100		200	8	201,00	714 x 707 x 1400	2.185,00	
761010453	HE115434GR	100		200	8	200,00	714 x 707 x 1400	2.185,00	
761010454	HE115435GR	100		200	10	225,50	714 x 707 x 1400	2.519,00	
761010455	HE115436GR	100		200	10	226,00	714 x 707 x 1400	2.525,00	
761010456	HE115437GR	100		200	11	236,50	714 x 707 x 1400	2.669,00	
761010457	HE115438GR	100		200	12	250,50	714 x 707 x 1400	2.855,00	
761010458	HE115439GR	100		200	13	264,00	714 x 707 x 1400	3.029,00	
761010441	HE115421GR	100		100	8	166,00	714 x 707 x 1400	2.099,00	
761010442	HE115422GR	100		100	8	165,00	714 x 707 x 1400	2.099,00	
761010443	HE115423GR	100		100	10	184,00	714 x 707 x 1400	2.389,00	
761010444	HE115424GR	100		100	10	185,00	714 x 707 x 1400	2.409,00	
761010445	HE115425GR	100		100	11	192,50	714 x 707 x 1400	2.545,00	
761010446	HE115426GR	100		100	11	189,50	714 x 707 x 1400	2.539,00	
761010447	HE115427GR	100		100	12	202,00	714 x 707 x 1400	2.679,00	
761010448	HE115428GR	100		100	12	195,00	714 x 707 x 1400	2.705,00	
761010449	HE115429GR	100		100	13	218,50	714 x 707 x 1400	2.875,00	
761003576	HE115411GR	90	✓	100	7	144,50	714 x 707 x 1400	1.665,00	
761003577	HE115412GR	90	✓	100	7	146,00	714 x 707 x 1400	1.665,00	
761003578	HE115413GR	90	✓	100	8	152,00	714 x 707 x 1400	1.769,00	
761003579	HE115414GR	90	✓	100	8	151,00	714 x 707 x 1400	1.769,00	
761003580	HE115415GR	90	✓	100	10	164,00	714 x 707 x 1400	1.989,00	
761003581	HE115416GR	90	✓	100	10	167,00	714 x 707 x 1400	1.999,00	
761003582	HE115417GR	90	✓	100	11	169,00	714 x 707 x 1400	2.089,00	
761003583	HE115418GR	90	✓	100	12	178,00	714 x 707 x 1400	2.215,00	
761003584	HE115419GR	90	✓	100	13	192,00	714 x 707 x 1400	2.345,00	
761010757	HE122411GR	90		100	7	114,00	714 x 600 x 1400	1.499,00	
761010758	HE122412GR	90		100	7	114,00	714 x 600 x 1400	1.499,00	
761010759	HE122413GR	90		100	8	120,00	714 x 600 x 1400	1.575,00	
761010760	HE122414GR	90		100	8	121,00	714 x 600 x 1400	1.575,00	
761010761	HE122415GR	90		100	10	132,00	714 x 600 x 1400	1.779,00	
761010762	HE122416GR	90		100	10	126,00	714 x 600 x 1400	1.779,00	
761010763	HE122417GR	90		100	11	138,00	714 x 600 x 1400	1.869,00	
761010764	HE122418GR	90		100	12	118,50	714 x 600 x 1400	1.979,00	
761010765	HE122419GR	90		100	13	150,00	714 x 600 x 1400	2.069,00	

EQUIPMENT



Ladenkasten in zeer stabiele en zware uitvoering, geschikt voor intensief en industrieel gebruik. Constructie in plaatstaal 10/10mm (kast) en 15/10mm (laden)..

- breedte 1020mm, en hoogte 700mm
- centrale vergrendeling met een cilinderslot (+2 sleutels)
- zeer hoogwaardige lagergeleidingen
- 1-lade uittrekbeveiliging voorkomt omkantelen
- verschillende compartimenten en lade-indelingen mogelijk
- Diepte 707mm of 600mm mogelijk
- Afwerking: blauwe poederlak coating in lichte hamerslag uitvoering

Verskillende mogelijke laden:

- Laden 100% uittrekbaar met een draagvermogen van 50kg
- Laden 90% uittrekbaar met een draagvermogen van 100kg - Zelfsluitend
- Laden 100% uittrekbaar met een draagvermogen van 100kg
- Laden 100% uittrekbaar met een draagvermogen van 200kg

Optie: Meerdere kasten kunnen op aanvraag met lopersleutel worden geleverd.



Order nr.	Orig. nr.	Uittrekbaar		Capaciteit lades	Aantal laden	Gewicht	Afmetingen (l x b x h)	Prijs
		Zelfsluitend	%					
761000563	HE119111BL	✓	90	100	3	107,50	1020 x 707 x 700	1.165,00
761000564	HE119112BL	✓	90	100	4	120,00	1020 x 707 x 700	1.309,00
761000565	HE119113BL	✓	90	100	4	118,00	1020 x 707 x 700	1.319,00
761000566	HE119114BL	✓	90	100	4	117,50	1020 x 707 x 700	1.309,00
761000567	HE119115BL	✓	90	100	4	119,50	1020 x 707 x 700	1.319,00
761000568	HE119116BL	✓	90	100	5	129,00	1020 x 707 x 700	1.455,00
761000569	HE119117BL	✓	90	100	5	130,50	1020 x 707 x 700	1.459,00
761000570	HE119118BL	✓	90	100	6	144,00	1020 x 707 x 700	1.575,00
761000571	HE119119BL	✓	90	100	8	158,00	1020 x 707 x 700	1.849,00
761000572	HE119121BL		100	100	3	115,50	1020 x 707 x 700	1.295,00
761000573	HE119122BL		100	100	4	129,00	1020 x 707 x 700	1.489,00
761000574	HE119123BL		100	100	4	130,00	1020 x 707 x 700	1.499,00
761000575	HE119124BL		100	100	4	129,50	1020 x 707 x 700	1.489,00
761000576	HE119125BL		100	100	5	144,00	1020 x 707 x 700	1.665,00
761000581	HE119126BL		100	100	5	143,50	1020 x 707 x 700	1.665,00
761000582	HE119127BL		100	100	5	144,00	1020 x 707 x 700	1.675,00
761000583	HE119128BL		100	100	6	159,00	1020 x 707 x 700	1.869,00
761000584	HE119129BL		100	100	8	186,00	1020 x 707 x 700	2.235,00
761000585	HE119131BL		100	200	3	131,00	1020 x 707 x 700	1.399,00
761000586	HE119132BL		100	200	4	150,00	1020 x 707 x 700	1.609,00
761000587	HE119133BL		100	200	4	152,00	1020 x 707 x 700	1.619,00
761000588	HE119134BL		100	200	4	149,50	1020 x 707 x 700	1.605,00
761000589	HE119135BL		100	200	4	150,50	1020 x 707 x 700	1.609,00
761000590	HE119136BL		100	200	5	169,50	1020 x 707 x 700	1.835,00
761000591	HE119137BL		100	200	5	169,50	1020 x 707 x 700	1.849,00
761000592	HE119138BL		100	200	6	189,00	1020 x 707 x 700	2.079,00
761000593	HE119139BL		100	200	8	226,00	1020 x 707 x 700	2.509,00
761001964	HE123111		90	100	3	87,00	1020 x 600 x 700	1.039,00
761001965	HE123112		90	100	4	95,00	1020 x 600 x 700	1.155,00
761001966	HE123113		90	100	4	94,00	1020 x 600 x 700	1.169,00
761001967	HE123114		90	100	4	95,00	1020 x 600 x 700	1.169,00
761001968	HE123115		90	100	4	95,00	1020 x 600 x 700	1.159,00
761001969	HE123116		90	100	5	102,00	1020 x 600 x 700	1.295,00
761001970	HE123117		90	100	5	103,00	1020 x 600 x 700	1.289,00
761001971	HE123118		90	100	6	111,00	1020 x 600 x 700	1.399,00
761001972	HE123119		90	100	8	124,00	1020 x 600 x 700	1.675,00

3 laden



H150mm
H200mm
H250mm

HE119111 - HE119121
HE119131 - HE123111

4 laden



H100mm
H100mm
H200mm
H200mm

HE119112 - HE119122
HE119132 - HE123112

4 laden



H150mm
H150mm
H150mm
H150mm

HE119113 - HE119123
HE119133 - HE123113

4 laden



H75mm
H75mm
H200mm
H250mm

HE119114 - HE119134
HE123114

4 laden



H100mm
H100mm
H150mm
H250mm

HE119115 - HE119135
HE123115

4 laden



H50mm
H100mm
H200mm
H250mm

HE119124

5 laden



H75mm
H100mm
H100mm
H125mm
H200mm

HE119117 - HE119127
HE119137 - HE123117

5 laden



H75mm
H75mm
H100mm
H150mm
H200mm

HE119116 - HE119126
HE119136 - HE123116

5 laden



H50mm
H75mm
H75mm
H150mm
H250mm

HE119125

6 laden



H100mm
H100mm
H100mm
H100mm
H100mm
H100mm

HE119118 - HE119128
HE119138 - HE123118

8 laden



H75mm
H75mm
H75mm
H75mm
H75mm
H75mm
H75mm
H75mm

HE119119 - HE119129
HE119139 - HE123119

OOK IN ANDERE KLEUREN BESCHIKBAAR

ORIG. NR. MET EXTENSIE GR
ORIG. NR. MET EXTENSIE RL

ONDERVERDELINGEN

p. 558



EQUIPMENT



Ladenkasten in zeer stabiele en zware uitvoering, geschikt voor intensief en industrieel gebruik. Constructie in plaatstaal 10/10mm (kast) en 15/10mm (laden)..

- breedte 1020mm, en hoogte 700mm
- centrale vergrendeling met een cilinderslot (+2 sleutels)
- zeer hoogwaardige lagergeleidingen
- 1-lade uittrekbeveiliging voorkomt omkantelen
- verschillende compartimenten en lade-indelingen mogelijk
- Diepte 707mm of 600mm mogelijk
- Afwerking: rode poederlak coating in lichte hamerslag uitvoering

INFO
p. 541



Verskillende mogelijke laden:

- Laden 100% uittrekbaar met een draagvermogen van 50kg
- Laden 90% uittrekbaar met een draagvermogen van 100kg - Zelfsluitend
- Laden 100% uittrekbaar met een draagvermogen van 100kg
- Laden 100% uittrekbaar met een draagvermogen van 200kg

Optie: Meerdere kasten kunnen op aanvraag met lopersleutel worden geleverd.

Order nr.	Orig. nr.	Uittrekbaar		Capaciteit lades	Aantal laden	Gewicht kg	Afmetingen (l x b x h)		Prijs €
		Zelfsluitend	%				mm	mm	
761033631	HE119111RE	✓	90	100	3	107,50	1020 x 707 x 700	1.165,00	
761033632	HE119112RE	✓	90	100	4	120,00	1020 x 707 x 700	1.309,00	
761033633	HE119113RE	✓	90	100	4	118,00	1020 x 707 x 700	1.319,00	
761033634	HE119114RE	✓	90	100	4	117,50	1020 x 707 x 700	1.309,00	
761033635	HE119115RE	✓	90	100	4	119,50	1020 x 707 x 700	1.319,00	
761033636	HE119116RE	✓	90	100	5	129,00	1020 x 707 x 700	1.455,00	
761033637	HE119117RE	✓	90	100	5	130,50	1020 x 707 x 700	1.459,00	
761033638	HE119118RE	✓	90	100	6	144,00	1020 x 707 x 700	1.575,00	
761033639	HE119119RE	✓	90	100	8	158,00	1020 x 707 x 700	1.849,00	
761020572	HE119121RE		100	100	3	115,50	1020 x 707 x 700	1.295,00	
761020573	HE119122RE		100	100	4	129,00	1020 x 707 x 700	1.489,00	
761020574	HE119123RE		100	100	4	130,00	1020 x 707 x 700	1.499,00	
761020575	HE119124RE		100	100	4	129,50	1020 x 707 x 700	1.489,00	
761020576	HE119125RE		100	100	5	144,00	1020 x 707 x 700	1.665,00	
761020581	HE119126RE		100	100	5	143,50	1020 x 707 x 700	1.665,00	
761020582	HE119127RE		100	100	5	144,00	1020 x 707 x 700	1.675,00	
761020583	HE119128RE		100	100	6	159,00	1020 x 707 x 700	1.869,00	
761020584	HE119129RE		100	100	8	186,00	1020 x 707 x 700	2.235,00	
761020585	HE119131RE		100	200	3	131,00	1020 x 707 x 700	1.399,00	
761020586	HE119132RE		100	200	4	150,00	1020 x 707 x 700	1.609,00	
761020587	HE119133RE		100	200	4	152,00	1020 x 707 x 700	1.619,00	
761020588	HE119134RE		100	200	4	149,50	1020 x 707 x 700	1.605,00	
761020589	HE119135RE		100	200	4	150,50	1020 x 707 x 700	1.609,00	
761020590	HE119136RE		100	200	5	169,50	1020 x 707 x 700	1.835,00	
761020591	HE119137RE		100	200	5	169,50	1020 x 707 x 700	1.849,00	
761020592	HE119138RE		100	200	6	189,00	1020 x 707 x 700	2.079,00	
761020593	HE119139RE		100	200	8	226,00	1020 x 707 x 700	2.509,00	
761033566	HE123111RE		90	100	3	105,50	1020 x 600 x 700	1.429,00	
761033567	HE123112RE		90	100	4	113,00	1020 x 600 x 700	1.545,00	
761033568	HE123113RE		90	100	4	112,00	1020 x 600 x 700	1.555,00	
761033569	HE123114RE		90	100	4	120,50	1020 x 600 x 700	1.675,00	
761033570	HE123115RE		90	100	4	128,00	1020 x 600 x 700	1.805,00	
761033571	HE123116RE		90	100	5	136,00	1020 x 600 x 700	1.925,00	
761033572	HE123117RE		90	100	5	137,50	1020 x 600 x 700	1.895,00	
761033573	HE123118RE		90	100	6	150,50	1020 x 600 x 700	2.195,00	
761033574	HE123119RE		90	100	8	157,00	1020 x 600 x 700	2.339,00	



Ladenkasten in zeer stabiele en zware uitvoering, geschikt voor intensief en industrieel gebruik. Constructie in plaatstaal 10/10mm (kast) en 15/10mm (laden)..

- breedte 1020mm, en hoogte 700mm
- centrale vergrendeling met een cilinderslot (+2 sleutels)
- zeer hoogwaardige lagergeleidingen
- 1-lade uittrekbeveiliging voorkomt omkantelen
- verschillende compartimenten en lade-indelingen mogelijk
- Diepte 707mm of 600mm mogelijk
- Afwerking: grijze poederlak coating in lichte hamerslag uitvoering



Verschillende mogelijke laden:

- Laden 100% uittrekbaar met een draagvermogen van 50kg
- Laden 90% uittrekbaar met een draagvermogen van 100kg - Zelfsluitend
- Laden 100% uittrekbaar met een draagvermogen van 100kg
- Laden 100% uittrekbaar met een draagvermogen van 200kg

Optie: Meerdere kasten kunnen op aanvraag met lopersleutel worden geleverd.

Order nr.	Orig. nr.	Uittrekbaar %	Zelfsluitend	Capaciteit lades kg	Aantal laden	Gewicht kg	Afmetingen (l x b x h) mm	Prijs €
761010585	HE119131GR	100		200	3	131,00	1020 x 707 x 700	1.399,00
761010586	HE119132GR	100		200	4	150,00	1020 x 707 x 700	1.609,00
761010587	HE119133GR	100		200	4	152,00	1020 x 707 x 700	1.619,00
761010588	HE119134GR	100		200	4	149,50	1020 x 707 x 700	1.605,00
761010589	HE119135GR	100		200	4	150,50	1020 x 707 x 700	1.609,00
761010590	HE119136GR	100		200	5	169,50	1020 x 707 x 700	1.835,00
761010591	HE119137GR	100		200	5	169,50	1020 x 707 x 700	1.849,00
761010592	HE119138GR	100		200	6	189,00	1020 x 707 x 700	2.079,00
761010593	HE119139GR	100		200	8	226,00	1020 x 707 x 700	2.509,00
761033593	HE123111GR	90		100	3	105,50	1020 x 600 x 700	1.429,00
761033594	HE123112GR	90		100	4	113,00	1020 x 600 x 700	1.545,00
761033595	HE123113GR	90		100	4	112,00	1020 x 600 x 700	1.555,00
761033596	HE123114GR	90		100	4	120,50	1020 x 600 x 700	1.675,00
761033597	HE123115GR	90		100	4	128,00	1020 x 600 x 700	1.805,00
761033598	HE123116GR	90		100	5	136,00	1020 x 600 x 700	1.925,00
761033599	HE123117GR	90		100	5	137,50	1020 x 600 x 700	1.895,00
761033600	HE123118GR	90		100	6	150,50	1020 x 600 x 700	2.195,00
761033601	HE123119GR	90		100	8	157,00	1020 x 600 x 700	2.339,00
761010572	HE119121GR	100		100	3	115,50	1020 x 707 x 700	1.295,00
761010573	HE119122GR	100		100	4	129,00	1020 x 707 x 700	1.489,00
761010574	HE119123GR	100		100	4	130,00	1020 x 707 x 700	1.499,00
761010575	HE119124GR	100		100	4	129,50	1020 x 707 x 700	1.489,00
761010576	HE119125GR	100		100	5	144,00	1020 x 707 x 700	1.665,00
761010581	HE119126GR	100		100	5	143,50	1020 x 707 x 700	1.665,00
761010582	HE119127GR	100		100	5	144,00	1020 x 707 x 700	1.675,00
761010583	HE119128GR	100		100	6	159,00	1020 x 707 x 700	1.869,00
761010584	HE119129GR	100		100	8	186,00	1020 x 707 x 700	2.235,00
761033658	HE119111GR	90	✓	100	3	107,50	1020 x 707 x 700	1.165,00
761033659	HE119112GR	90	✓	100	4	120,00	1020 x 707 x 700	1.309,00
761033660	HE119113GR	90	✓	100	4	118,00	1020 x 707 x 700	1.319,00
761033661	HE119114GR	90	✓	100	4	117,50	1020 x 707 x 700	1.309,00
761033662	HE119115GR	90	✓	100	4	119,50	1020 x 707 x 700	1.319,00
761033663	HE119116GR	90	✓	100	5	129,00	1020 x 707 x 700	1.455,00
761033664	HE119117GR	90	✓	100	5	130,50	1020 x 707 x 700	1.459,00
761033665	HE119118GR	90	✓	100	6	144,00	1020 x 707 x 700	1.575,00
761033666	HE119119GR	90	✓	100	8	158,00	1020 x 707 x 700	1.849,00

EQUIPMENT



Ladenkasten in zeer stabiele en zware uitvoering, geschikt voor intensief en industrieel gebruik. Constructie in plaatstaal 10/10mm (kast) en 15/10mm (laden)..

- breedte 1020mm, en hoogte 1000mm
- centrale vergrendeling met een cilinderslot (+2 sleutels)
- zeer hoogwaardige lagergeleidingen
- 1-lade uittrekbeveiliging voorkomt omkantelen
- verschillende compartimenten en lade-indelingen mogelijk
- Diepte 707mm of 600mm mogelijk
- Afwerking: blauwe poederlak coating in lichte hamerslag uitvoering

Verskillende mogelijke laden:

- Laden 100% uittrekbaar met een draagvermogen van 50kg
- Laden 90% uittrekbaar met een draagvermogen van 100kg - Zelfsluitend
- Laden 100% uittrekbaar met een draagvermogen van 100kg
- Laden 100% uittrekbaar met een draagvermogen van 200kg

Optie: Meerdere kasten kunnen op aanvraag met lopersleutel worden geleverd.



Order nr.	Orig. nr.	Uittrekbaar %	Zelfsluitend	Capaciteit lades kg	Aantal laden	Gewicht kg	Afmetingen (l x b x h) mm	Prijs €
761000604	HE119211BL	90	✓	100	5	149,00	1020 x 707 x 1000	1.605,00
761000605	HE119212BL	90	✓	100	6	159,00	1020 x 707 x 1000	1.749,00
761000606	HE119213BL	90	✓	100	6	158,00	1020 x 707 x 1000	1.765,00
761000607	HE119214BL	90	✓	100	7	169,00	1020 x 707 x 1000	1.895,00
761000608	HE119215BL	90	✓	100	8	181,00	1020 x 707 x 1000	2.045,00
761000609	HE119216BL	90	✓	100	9	192,50	1020 x 707 x 1000	2.185,00
761000610	HE119217BL	90	✓	100	9	197,00	1020 x 707 x 1000	2.185,00
761000611	HE119218BL	90	✓	100	11	211,00	1020 x 707 x 1000	2.449,00
761000612	HE119219BL	90	✓	100	12	218,00	1020 x 707 x 1000	2.585,00
761000613	HE119221BL	100		100	6	173,50	1020 x 707 x 1000	2.025,00
761000614	HE119222BL	100		100	6	176,00	1020 x 707 x 1000	2.035,00
761000615	HE119223BL	100		100	7	190,00	1020 x 707 x 1000	2.215,00
761000616	HE119224BL	100		100	8	203,00	1020 x 707 x 1000	2.399,00
761000617	HE119225BL	100		100	9	218,00	1020 x 707 x 1000	2.605,00
761000618	HE119226BL	100		100	9	219,00	1020 x 707 x 1000	2.619,00
761000619	HE119227BL	100		100	9	219,50	1020 x 707 x 1000	2.619,00
761000620	HE119228BL	100		100	9	260,00	1020 x 707 x 1000	3.169,00
761000621	HE119229BL	100		100	12	260,00	1020 x 707 x 1000	3.169,00
761000622	HE119231BL	100		200	5	186,00	1020 x 707 x 1000	1.999,00
761000623	HE119232BL	100		200	6	205,00	1020 x 707 x 1000	2.235,00
761000624	HE119233BL	100		200	6	209,00	1020 x 707 x 1000	2.235,00
761000625	HE119234BL	100		200	7	225,00	1020 x 707 x 1000	2.455,00
761000626	HE119235BL	100		200	8	246,00	1020 x 707 x 1000	2.695,00
761000627	HE119236BL	100		200	9	264,50	1020 x 707 x 1000	2.915,00
761000628	HE119237BL	100		200	9	264,50	1020 x 707 x 1000	2.915,00
761000629	HE119238BL	100		200	11	301,50	1020 x 707 x 1000	3.349,00
761000630	HE119239BL	100		200	12	320,00	1020 x 707 x 1000	2.595,00
761000784	HE123211	90		100	5	105,50	1020 x 600 x 1000	1.429,00
761000785	HE123212	90		100	6	113,00	1020 x 600 x 1000	1.545,00
761000786	HE123213	90		100	6	112,00	1020 x 600 x 1000	1.555,00
761000787	HE123214	90		100	7	120,50	1020 x 600 x 1000	1.675,00
761000788	HE123215	90		100	8	128,00	1020 x 600 x 1000	1.805,00
761000789	HE123216	90		100	9	136,00	1020 x 600 x 1000	1.925,00
761000790	HE123217	90		100	9	137,50	1020 x 600 x 1000	1.895,00
761000791	HE123218	90		100	11	150,50	1020 x 600 x 1000	2.195,00
761000792	HE123219	90		100	12	157,00	1020 x 600 x 1000	2.339,00

5 laden



H100mm
H200mm
H200mm
H200mm
H200mm

HE119211 - HE119231
HE123211

6 laden



H75mm
H100mm
H125mm
H150mm
H200mm
H250mm

HE119212 - HE119221
HE119232 - HE123212

6 laden



H150mm
H150mm
H150mm
H150mm
H150mm
H150mm

HE119213 - HE119222
HE119233 - HE123213

7 laden



H75mm
H75mm
H75mm
H100mm
H125mm
H200mm
H250mm

HE119214 - HE119223
HE119234 - HE123214

8 laden



H75mm
H75mm
H100mm
H100mm
H125mm
H125mm
H150mm
H150mm

HE119215 - HE119235
HE123215

8 laden



H50mm
H50mm
H75mm
H100mm
H100mm
H125mm
H200mm
H200mm

HE119224

9 laden



H100mm
H100mm
H100mm
H100mm
H100mm
H100mm
H100mm
H100mm
H100mm

HE119217 - HE119227
HE119237 - HE123217

9 laden



H75mm
H75mm
H75mm
H100mm
H100mm
H100mm
H100mm
H125mm
H150mm

HE119216 - HE119226
HE119236 - HE123216

9 laden



H50mm
H50mm
H75mm
H75mm
H100mm
H100mm
H125mm
H125mm
H200mm

HE119225

11 laden



H75mm
H75mm
H75mm
H75mm
H75mm
H75mm
H75mm
H75mm
H75mm
H100mm
H100mm

HE119218 - HE119238
HE123218

12 laden



H75mm
H75mm
H75mm
H75mm
H75mm
H75mm
H75mm
H75mm
H75mm
H75mm
H75mm
H75mm

HE119219 - HE119229
HE119239 - HE123219

12 laden



H50mm
H50mm
H50mm
H75mm
H75mm
H75mm
H75mm
H75mm
H75mm
H100mm
H100mm
H100mm

HE119228

EQUIPMENT

ONDERVERDELINGEN

p. 558

OOK IN ANDERE KLEUREN BESCHIKBAAR

ORIG-NR MET EXTENSIE GR

ORIG-NR MET EXTENSIE RL





Ladenkasten in zeer stabiele en zware uitvoering, geschikt voor intensief en industrieel gebruik. Constructie in plaatstaal 10/10mm (kast) en 15/10mm (laden)..

- breedte 1020mm, en hoogte 1000mm
- centrale vergrendeling met een cilinderslot (+2 sleutels)
- zeer hoogwaardige lagergeleidingen
- 1-lade uittrekbeveiliging voorkomt omkantelen
- verschillende compartimenten en lade-indelingen mogelijk
- Diepte 707mm of 600mm mogelijk
- Afwerking: rode poederlak coating in lichte hamerslag uitvoering



Verschillende mogelijke laden:

- Laden 100% uittrekbaar met een draagvermogen van 50kg
- Laden 90% uittrekbaar met een draagvermogen van 100kg - Zelfsluitend
- Laden 100% uittrekbaar met een draagvermogen van 100kg
- Laden 100% uittrekbaar met een draagvermogen van 200kg

Optie: Meerdere kasten kunnen op aanvraag met lopersleutel worden geleverd.

Order nr.	Orig. nr.	Uittrekbaar	Zelfsluitend	Capaciteit	Aantal laden	Gewicht	Afmetingen (l x b x h)	Prijs
				lades		kg		mm
761033640	HE119211RE	90	✓	100	5	149,00	1020 x 707 x 1000	1.605,00
761033641	HE119212RE	90	✓	100	6	159,00	1020 x 707 x 1000	1.749,00
761033642	HE119213RE	90	✓	100	6	158,00	1020 x 707 x 1000	1.765,00
761033643	HE119214RE	90	✓	100	7	169,00	1020 x 707 x 1000	1.895,00
761033644	HE119215RE	90	✓	100	8	181,00	1020 x 707 x 1000	2.045,00
761033645	HE119216RE	90	✓	100	9	192,50	1020 x 707 x 1000	2.185,00
761033646	HE119217RE	90	✓	100	9	197,00	1020 x 707 x 1000	2.185,00
761033647	HE119218RE	90	✓	100	11	211,00	1020 x 707 x 1000	2.449,00
761033648	HE119219RE	90	✓	100	12	218,00	1020 x 707 x 1000	2.585,00
761020613	HE119221RE	100		100	6	173,50	1020 x 707 x 1000	2.025,00
761020614	HE119222RE	100		100	6	176,00	1020 x 707 x 1000	2.035,00
761020615	HE119223RE	100		100	7	190,00	1020 x 707 x 1000	2.215,00
761020616	HE119224RE	100		100	8	203,00	1020 x 707 x 1000	2.399,00
761020617	HE119225RE	100		100	9	218,00	1020 x 707 x 1000	2.605,00
761020618	HE119226RE	100		100	9	219,00	1020 x 707 x 1000	2.619,00
761020619	HE119227RE	100		100	9	219,50	1020 x 707 x 1000	2.619,00
761020620	HE119228RE	100		100	9	260,00	1020 x 707 x 1000	3.169,00
761020621	HE119229RE	100		100	12	260,00	1020 x 707 x 1000	3.169,00
761020622	HE119231RE	100		200	5	186,00	1020 x 707 x 1000	1.999,00
761020623	HE119232RE	100		200	6	205,00	1020 x 707 x 1000	2.235,00
761020624	HE119233RE	100		200	6	209,00	1020 x 707 x 1000	2.235,00
761020625	HE119234RE	100		200	7	225,00	1020 x 707 x 1000	2.455,00
761020626	HE119235RE	100		200	8	246,00	1020 x 707 x 1000	2.695,00
761020627	HE119236RE	100		200	9	264,50	1020 x 707 x 1000	2.915,00
761020628	HE119237RE	100		200	9	264,50	1020 x 707 x 1000	2.915,00
761020629	HE119238RE	100		200	11	301,50	1020 x 707 x 1000	3.349,00
761020630	HE119239RE	100		200	12	320,00	1020 x 707 x 1000	2.595,00
761033575	HE1123211RE	90		100	5	142,50	1020 x 600 x 1400	1.935,00
761033576	HE1123212RE	90		100	6	142,00	1020 x 600 x 1400	1.945,00
761033577	HE1123213RE	90		100	6	151,00	1020 x 600 x 1400	2.069,00
761033578	HE1123214RE	90		100	7	150,50	1020 x 600 x 1400	2.079,00
761033579	HE1123215RE	90		100	8	165,00	1020 x 600 x 1400	2.339,00
761033580	HE1123216RE	90		100	9	155,00	1020 x 600 x 1400	2.329,00
761033581	HE1123217RE	90		100	9	172,00	1020 x 600 x 1400	2.479,00
761033582	HE1123218RE	90		100	11	179,50	1020 x 600 x 1400	2.605,00
761033583	HE1123219RE	90		100	12	177,50	1020 x 600 x 1400	2.669,00



Ladenkasten in zeer stabiele en zware uitvoering, geschikt voor intensief en industrieel gebruik. Constructie in plaatstaal 10/10mm (kast) en 15/10mm (laden)..

- breedte 1020mm, en hoogte 1000mm
- centrale vergrendeling met een cilinderslot (+2 sleutels)
- zeer hoogwaardige lagerveleidingen
- 1-lade uittrekbeveiliging voorkomt omkantelen
- verschillende compartimenten en lade-indelingen mogelijk
- Diepte 707mm of 600mm mogelijk
- Afwerking: grijze poederlak coating in lichte hamerslag uitvoering



Verskillende mogelijke laden:

- Laden 100% uittrekbaar met een draagvermogen van 50kg
- Laden 90% uittrekbaar met een draagvermogen van 100kg - Zelfsluitend
- Laden 100% uittrekbaar met een draagvermogen van 100kg
- Laden 100% uittrekbaar met een draagvermogen van 200kg

Optie: Meerdere kasten kunnen op aanvraag met lopersleutel worden geleverd.

Order nr.	Orig. nr.	Uittrekbaar	Zelfsluitend	Capaciteit	Aantal laden	Gewicht	Afmetingen (l x b x h)	Prijs
				lades				kg
761010622	HE119231GR	100		200	5	186,00	1020 x 707 x 1000	1.999,00
761010623	HE119232GR	100		200	6	205,00	1020 x 707 x 1000	2.235,00
761010624	HE119233GR	100		200	6	209,00	1020 x 707 x 1000	2.235,00
761010625	HE119234GR	100		200	7	225,00	1020 x 707 x 1000	2.455,00
761010626	HE119235GR	100		200	8	246,00	1020 x 707 x 1000	2.695,00
761010627	HE119236GR	100		200	9	264,50	1020 x 707 x 1000	2.915,00
761010628	HE119237GR	100		200	9	264,50	1020 x 707 x 1000	2.915,00
761010629	HE119238GR	100		200	11	301,50	1020 x 707 x 1000	3.349,00
761010630	HE119239GR	100		200	12	320,00	1020 x 707 x 1000	2.595,00
761033602	HE123211GR	90		100	5	142,50	1020 x 600 x 1400	1.935,00
761033603	HE123212GR	90		100	6	142,00	1020 x 600 x 1400	1.945,00
761033604	HE123213GR	90		100	6	151,00	1020 x 600 x 1400	2.069,00
761033605	HE123214GR	90		100	7	150,50	1020 x 600 x 1400	2.079,00
761033606	HE123215GR	90		100	8	165,00	1020 x 600 x 1400	2.339,00
761033607	HE123216GR	90		100	9	155,00	1020 x 600 x 1400	2.329,00
761033608	HE123217GR	90		100	9	172,00	1020 x 600 x 1400	2.479,00
761033609	HE123218GR	90		100	11	179,50	1020 x 600 x 1400	2.605,00
761033610	HE123219GR	90		100	12	177,50	1020 x 600 x 1400	2.669,00
761010613	HE119221GR	100		100	6	173,50	1020 x 707 x 1000	2.025,00
761010614	HE119222GR	100		100	6	176,00	1020 x 707 x 1000	2.035,00
761010615	HE119223GR	100		100	7	190,00	1020 x 707 x 1000	2.215,00
761010616	HE119224GR	100		100	8	203,00	1020 x 707 x 1000	2.399,00
761010617	HE119225GR	100		100	9	218,00	1020 x 707 x 1000	2.605,00
761010618	HE119226GR	100		100	9	219,00	1020 x 707 x 1000	2.619,00
761010619	HE119227GR	100		100	9	219,50	1020 x 707 x 1000	2.619,00
761010620	HE119228GR	100		100	9	260,00	1020 x 707 x 1000	3.169,00
761010621	HE119229GR	100		100	12	260,00	1020 x 707 x 1000	3.169,00
761033667	HE119211GR	90	✓	100	5	149,00	1020 x 707 x 1000	1.605,00
761033668	HE119212GR	90	✓	100	6	159,00	1020 x 707 x 1000	1.749,00
761033669	HE119213GR	90	✓	100	6	158,00	1020 x 707 x 1000	1.765,00
761033670	HE119214GR	90	✓	100	7	169,00	1020 x 707 x 1000	1.895,00
761033671	HE119215GR	90	✓	100	8	181,00	1020 x 707 x 1000	2.045,00
761033672	HE119216GR	90	✓	100	9	192,50	1020 x 707 x 1000	2.185,00
761033673	HE119217GR	90	✓	100	9	197,00	1020 x 707 x 1000	2.185,00
761033674	HE119218GR	90	✓	100	11	211,00	1020 x 707 x 1000	2.449,00
761033675	HE119219GR	90	✓	100	12	218,00	1020 x 707 x 1000	2.585,00

EQUIPMENT



Ladenkasten in zeer stabiele en zware uitvoering, geschikt voor intensief en industrieel gebruik. Constructie in plaatstaal 10/10mm (kast) en 15/10mm (laden)..

- breedte 1020mm, en hoogte 1400mm
- centrale vergrendeling met een cilinderslot (+2 sleutels)
- zeer hoogwaardige lagereleidingen
- 1-lade uittrekbeveiliging voorkomt omkantelen
- verschillende compartimenten en lade-indelingen mogelijk
- Diepte 707mm of 600mm mogelijk
- Afwerking: blauwe poederlak coating in lichte hamerslag uitvoering

Verschillende mogelijke laden:

- Laden 100% uittrekbaar met een draagvermogen van 50kg
- Laden 90% uittrekbaar met een draagvermogen van 100kg - Zelfsluitend
- Laden 100% uittrekbaar met een draagvermogen van 100kg
- Laden 100% uittrekbaar met een draagvermogen van 200kg

Optie: Meerdere kasten kunnen op aanvraag met lopersleutel worden geleverd.

Order nr.	Orig. nr.	Uittrekbaar	Zelfsluitend	Capaciteit lades	Aantal laden	Gewicht	Afmetingen (l x b x h)		Prijs
							mm	€	
761000636	HE119411BL	90	✓	100	7	193,00	1020 x 707 x 1400	2.069,00	
761000637	HE119412BL	90	✓	100	7	192,00	1020 x 707 x 1400	2.079,00	
761000638	HE119413BL	90	✓	100	8	205,00	1020 x 707 x 1400	2.215,00	
761000639	HE119414BL	90	✓	100	8	203,50	1020 x 707 x 1400	2.215,00	
761000640	HE119415BL	90	✓	100	10	223,50	1020 x 707 x 1400	2.499,00	
761000641	HE119416BL	90	✓	100	10	225,50	1020 x 707 x 1400	2.509,00	
761000642	HE119417BL	90	✓	100	11	231,00	1020 x 707 x 1400	2.629,00	
761000643	HE119418BL	90	✓	100	12	243,00	1020 x 707 x 1400	2.789,00	
761000644	HE119419BL	90	✓	100	13	265,00	1020 x 707 x 1400	2.935,00	
761000645	HE119421BL	100		100	8	230,00	1020 x 707 x 1400	2.569,00	
761000646	HE119422BL	100		100	8	230,00	1020 x 707 x 1400	2.569,00	
761000647	HE119423BL	100		100	10	251,50	1020 x 707 x 1400	2.955,00	
761000648	HE119424BL	100		100	10	254,00	1020 x 707 x 1400	2.975,00	
761000649	HE119425BL	100		100	11	266,00	1020 x 707 x 1400	3.149,00	
761000650	HE119426BL	100		100	11	272,00	1020 x 707 x 1400	3.135,00	
761000651	HE119427BL	100		100	12	280,50	1020 x 707 x 1400	3.339,00	
761000652	HE119428BL	100		100	12	282,50	1020 x 707 x 1400	3.355,00	
761000653	HE119429BL	100		100	13	297,50	1020 x 707 x 1400	3.559,00	
761000654	HE119431BL	100		200	7	245,50	1020 x 707 x 1400	2.619,00	
761000655	HE119432BL	100		200	7	246,50	1020 x 707 x 1400	2.619,00	
761000656	HE119433BL	100		200	8	265,00	1020 x 707 x 1400	2.849,00	
761000657	HE119434BL	100		200	8	265,00	1020 x 707 x 1400	2.849,00	
761000658	HE119435BL	100		200	10	303,50	1020 x 707 x 1400	3.309,00	
761000659	HE119436BL	100		200	10	304,50	1020 x 707 x 1400	3.315,00	
761000660	HE119437BL	100		200	11	321,50	1020 x 707 x 1400	3.515,00	
761000661	HE119438BL	100		200	12	342,50	1020 x 707 x 1400	3.759,00	
761000662	HE119439BL	100		200	13	362,50	1020 x 707 x 1400	3.999,00	
761000796	HE123411	90		100	7	142,50	1020 x 600 x 1400	1.935,00	
761000797	HE123412	90		100	7	142,00	1020 x 600 x 1400	1.945,00	
761000798	HE123413	90		100	8	151,00	1020 x 600 x 1400	2.069,00	
761000799	HE123414	90		100	8	150,50	1020 x 600 x 1400	2.079,00	
761000800	HE123415	90		100	10	165,00	1020 x 600 x 1400	2.339,00	
761000801	HE123416	90		100	10	155,00	1020 x 600 x 1400	2.329,00	
761000802	HE123417	90		100	11	172,00	1020 x 600 x 1400	2.479,00	
761000803	HE123418	90		100	12	179,50	1020 x 600 x 1400	2.605,00	
761000804	HE123419	90		100	13	177,50	1020 x 600 x 1400	2.669,00	

7 laden



H100mm
H200mm
H200mm
H200mm
H200mm
H200mm
H200mm

HE119411 - HE119431
HE123411

7 laden



H150mm
H150mm
H200mm
H200mm
H200mm
H200mm
H200mm

HE119412 - HE119432
HE123412

8 laden



H100mm
H100mm
H100mm
H100mm
H200mm
H250mm
H250mm

HE119413 - HE119433
HE119421 - HE123413

8 laden



H75mm
H100mm
H100mm
H125mm
H200mm
H200mm
H250mm
H250mm

HE119414 - HE119434
HE119422 - HE123414

10 laden



H75mm
H75mm
H75mm
H75mm
H100mm
H125mm
H125mm
H200mm
H200mm
H250mm

HE119415 - HE119435

10 laden



H75mm
H75mm
H100mm
H100mm
H100mm
H125mm
H125mm
H150mm
H200mm
H250mm

HE119424 - HE119416
HE119436 - HE123416

10 laden



H50mm
H50mm
H75mm
H100mm
H125mm
H150mm
H150mm
H200mm
H200mm
H200mm

HE119423

11 laden



H75mm
H75mm
H75mm
H75mm
H75mm
H75mm
H75mm
H200mm
H250mm
H250mm

HE119417 - HE119426
HE119437 - HE123415
HE123417

11 laden



H50mm
H50mm
H75mm
H75mm
H75mm
H125mm
H150mm
H150mm
H200mm
H200mm

HE119425

12 laden



H50mm
H50mm
H50mm
H50mm
H75mm
H75mm
H100mm
H100mm
H150mm
H150mm
H200mm
H200mm

HE119427

12 laden



H75mm
H75mm
H75mm
H75mm
H75mm
H75mm
H125mm
H125mm
H150mm
H250mm

HE119418 - HE119428
HE119438 - HE123418

13 laden



H100mm
H100mm
H100mm
H100mm
H100mm
H100mm
H100mm
H100mm
H100mm
H100mm
H100mm
H100mm

HE119419 - HE119429
HE119439 - HE123419

OOK IN ANDERE KLEUREN BESCHIKBAAR

ORIG. NX MET EXTENSIE GR
ORIG. NX MET EXTENSIE RL

EQUIPMENT



Ladenkasten in zeer stabiele en zware uitvoering, geschikt voor intensief en industrieel gebruik. Constructie in plaatstaal 10/10mm (kast) en 15/10mm (laden)..

- breedte 1020mm, en hoogte 1400mm
- centrale vergrendeling met een cilinderslot (+2 sleutels)
- zeer hoogwaardige lagergeleidingen
- 1-lade uittrekbeveiliging voorkomt omkantelen
- verschillende compartimenten en lade-indelingen mogelijk
- Diepte 707mm of 600mm mogelijk
- Afwerking: rode poederlak coating in lichte hamerslag uitvoering



Verskillende mogelijke laden:

- Laden 100% uittrekbaar met een draagvermogen van 50kg
 - Laden 90% uittrekbaar met een draagvermogen van 100kg - Zelfsluitend
 - Laden 100% uittrekbaar met een draagvermogen van 100kg
 - Laden 100% uittrekbaar met een draagvermogen van 200kg
- Optie:** Meerdere kasten kunnen op aanvraag met lopersleutel worden geleverd.

Order nr.	Orig. nr.	Uittrekbaar %	Zelfsluitend ✓	Capaciteit lades kg	Aantal laden	Gewicht kg	Afmetingen (l x b x h) mm	Prijs €
761033649	HE119411RE	90	✓	100	7	193,00	1020 x 707 x 1400	2.069,00
761033650	HE119412RE	90	✓	100	7	192,00	1020 x 707 x 1400	2.079,00
761033651	HE119413RE	90	✓	100	8	205,00	1020 x 707 x 1400	2.215,00
761033652	HE119414RE	90	✓	100	8	203,50	1020 x 707 x 1400	2.215,00
761033653	HE119415RE	90	✓	100	10	223,50	1020 x 707 x 1400	2.499,00
761033654	HE119416RE	90	✓	100	10	225,50	1020 x 707 x 1400	2.509,00
761033655	HE119417RE	90	✓	100	11	231,00	1020 x 707 x 1400	2.629,00
761033656	HE119418RE	90	✓	100	12	243,00	1020 x 707 x 1400	2.789,00
761033657	HE119419RE	90	✓	100	13	265,00	1020 x 707 x 1400	2.935,00
761020645	HE119421RE	100		100	8	230,00	1020 x 707 x 1400	2.569,00
761020646	HE119422RE	100		100	8	230,00	1020 x 707 x 1400	2.569,00
761020647	HE119423RE	100		100	10	251,50	1020 x 707 x 1400	2.955,00
761020648	HE119424RE	100		100	10	254,00	1020 x 707 x 1400	2.975,00
761020649	HE119425RE	100		100	11	266,00	1020 x 707 x 1400	3.149,00
761020650	HE119426RE	100		100	11	272,00	1020 x 707 x 1400	3.135,00
761020651	HE119427RE	100		100	12	280,50	1020 x 707 x 1400	3.339,00
761020652	HE119428RE	100		100	12	282,50	1020 x 707 x 1400	3.355,00
761020653	HE119429RE	100		100	13	297,50	1020 x 707 x 1400	3.559,00
761020654	HE119431RE	100		200	7	245,50	1020 x 707 x 1400	2.619,00
761020655	HE119432RE	100		200	7	246,50	1020 x 707 x 1400	2.619,00
761020656	HE119433RE	100		200	8	265,00	1020 x 707 x 1400	2.849,00
761020657	HE119434RE	100		200	8	265,00	1020 x 707 x 1400	2.849,00
761020658	HE119435RE	100		200	10	303,50	1020 x 707 x 1400	3.309,00
761020659	HE119436RE	100		200	10	304,50	1020 x 707 x 1400	3.315,00
761020660	HE119437RE	100		200	11	321,50	1020 x 707 x 1400	3.515,00
761020661	HE119438RE	100		200	12	342,50	1020 x 707 x 1400	3.759,00
761020662	HE119439RE	100		200	13	362,50	1020 x 707 x 1400	3.999,00
761033584	HE123411RE	90		100	7	87,00	1020 x 600 x 700	1.039,00
761033585	HE123412RE	90		100	7	95,00	1020 x 600 x 700	1.155,00
761033586	HE123413RE	90		100	8	94,00	1020 x 600 x 700	1.169,00
761033587	HE123414RE	90		100	8	95,00	1020 x 600 x 700	1.169,00
761033588	HE123415RE	90		100	10	95,00	1020 x 600 x 700	1.159,00
761033589	HE123416RE	90		100	10	102,00	1020 x 600 x 700	1.295,00
761033590	HE123417RE	90		100	11	103,00	1020 x 600 x 700	1.289,00
761033591	HE123418RE	90		100	12	111,00	1020 x 600 x 700	1.399,00
761033592	HE123419RE	90		100	13	124,00	1020 x 600 x 700	1.675,00



Ladenkasten in zeer stabiele en zware uitvoering, geschikt voor intensief en industrieel gebruik. Constructie in plaatstaal 10/10mm (kast) en 15/10mm (laden)..

- breedte 1020mm, en hoogte 1400mm
- centrale vergrendeling met een cilinderslot (+2 sleutels)
- zeer hoogwaardige lagergeleidingen
- 1-lade uittrekbeveiliging voorkomt omkantelen
- verschillende compartimenten en lade-indelingen mogelijk
- Diepte 707mm of 600mm mogelijk
- Afwerking: grijze poederlak coating in lichte hamerslag uitvoering



Verschillende mogelijke laden:

- Laden 100% uittrekbaar met een draagvermogen van 50kg
- Laden 90% uittrekbaar met een draagvermogen van 100kg - Zelfsluitend
- Laden 100% uittrekbaar met een draagvermogen van 100kg
- Laden 100% uittrekbaar met een draagvermogen van 200kg

Optie: Meerdere kasten kunnen op aanvraag met lopersleutel worden geleverd.

Order nr.	Orig. nr.	Uittrekbaar %	Zelfsluitend	Capaciteit lades kg	Aantal laden	Gewicht kg	Afmetingen (l x b x h) mm	Prijs €
761010654	HE119431GR	100		200	7	245,50	1020 x 707 x 1400	2.619,00
761010655	HE119432GR	100		200	7	246,50	1020 x 707 x 1400	2.619,00
761010656	HE119433GR	100		200	8	265,00	1020 x 707 x 1400	2.849,00
761010657	HE119434GR	100		200	8	265,00	1020 x 707 x 1400	2.849,00
761010658	HE119435GR	100		200	10	303,50	1020 x 707 x 1400	3.309,00
761010659	HE119436GR	100		200	10	304,50	1020 x 707 x 1400	3.315,00
761010660	HE119437GR	100		200	11	321,50	1020 x 707 x 1400	3.515,00
761010661	HE119438GR	100		200	12	342,50	1020 x 707 x 1400	3.759,00
761010662	HE119439GR	100		200	13	362,50	1020 x 707 x 1400	3.999,00
761033611	HE123411GR	90		100	7	87,00	1020 x 600 x 700	1.039,00
761033612	HE123412GR	90		100	7	95,00	1020 x 600 x 700	1.155,00
761033613	HE123413GR	90		100	8	94,00	1020 x 600 x 700	1.169,00
761033614	HE123414GR	90		100	8	95,00	1020 x 600 x 700	1.169,00
761033615	HE123415GR	90		100	10	95,00	1020 x 600 x 700	1.159,00
761033616	HE123416GR	90		100	10	102,00	1020 x 600 x 700	1.295,00
761033617	HE123417GR	90		100	11	103,00	1020 x 600 x 700	1.289,00
761033618	HE123418GR	90		100	12	111,00	1020 x 600 x 700	1.399,00
761033619	HE123419GR	90		100	13	124,00	1020 x 600 x 700	1.675,00
761010645	HE119421GR	100		100	8	230,00	1020 x 707 x 1400	2.569,00
761010646	HE119422GR	100		100	8	230,00	1020 x 707 x 1400	2.569,00
761010647	HE119423GR	100		100	10	251,50	1020 x 707 x 1400	2.955,00
761010648	HE119424GR	100		100	10	254,00	1020 x 707 x 1400	2.975,00
761010649	HE119425GR	100		100	11	266,00	1020 x 707 x 1400	3.149,00
761010650	HE119426GR	100		100	11	272,00	1020 x 707 x 1400	3.135,00
761010651	HE119427GR	100		100	12	280,50	1020 x 707 x 1400	3.339,00
761010652	HE119428GR	100		100	12	282,50	1020 x 707 x 1400	3.355,00
761010653	HE119429GR	100		100	13	297,50	1020 x 707 x 1400	3.559,00
761033676	HE119411GR	90	✓	100	7	193,00	1020 x 707 x 1400	2.069,00
761033677	HE119412GR	90	✓	100	7	192,00	1020 x 707 x 1400	2.079,00
761033678	HE119413GR	90	✓	100	8	205,00	1020 x 707 x 1400	2.215,00
761033679	HE119414GR	90	✓	100	8	203,50	1020 x 707 x 1400	2.215,00
761033680	HE119415GR	90	✓	100	10	223,50	1020 x 707 x 1400	2.499,00
761033681	HE119416GR	90	✓	100	10	225,50	1020 x 707 x 1400	2.509,00
761033682	HE119417GR	90	✓	100	11	231,00	1020 x 707 x 1400	2.629,00
761033683	HE119418GR	90	✓	100	12	243,00	1020 x 707 x 1400	2.789,00
761033684	HE119419GR	90	✓	100	13	265,00	1020 x 707 x 1400	2.935,00



• Plaatdikte 10/10 mm, Laden 15/10 mm

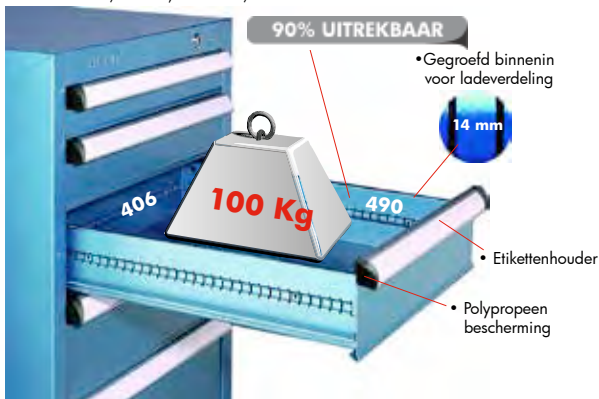

• Zeer goede inzicht op de lade inhoud



• Centrale vergrendeling



• Anti-omkeer mechanisme

Ladenkasten in zeer stabiele en zware uitvoering, geschikt voor intensief en industrieel gebruik. Constructie in plaatstaal 10/10mm met een poederlak coating in lichte hamerslag uitvoering.

- laden 90% uittrekbaar met een draagvermogen van 100kg
- breedte 515mm, diepte 600mm en 3 hoogtes (700, 1000 en 1400mm)
- centrale vergrendeling met een cilinderslot (+2 sleutels)
- zeer hoogwaardige lagergeleidingen
- 1-lade uittrekbeveiliging voorkomt omkantelen
- verschillende compartimenten en lade-indelingen mogelijk

Order nr.	Orig. nr.	Uittrekbaar %	Capaciteit lades kg	Aantal laden	Gewicht kg	Afmetingen (l x b x h) mm	Prijs €
761000944	HE135111BL	90	100	2	44,00	515 x 600 x 700	605,00
761000945	HE135112BL	90	100	4	54,50	515 x 600 x 700	819,00
761000946	HE135113BL	90	100	4	55,00	515 x 600 x 700	819,00
761000947	HE135114BL	90	100	4	54,00	515 x 600 x 700	815,00
761000948	HE135115BL	90	100	4	54,50	515 x 600 x 700	815,00
761000949	HE135116BL	90	100	5	59,50	515 x 600 x 700	899,00
761000950	HE135117BL	90	100	5	59,50	515 x 600 x 700	899,00
761000951	HE135118BL	90	100	6	65,00	515 x 600 x 700	995,00
761000952	HE135119BL	90	100	8	75,00	515 x 600 x 700	1.185,00
761000964	HE135211BL	90	100	5	71,00	515 x 600 x 1000	1.049,00
761000965	HE135212BL	90	100	6	77,00	515 x 600 x 1000	1.145,00
761000966	HE135213BL	90	100	6	78,00	515 x 600 x 1000	1.155,00
761000967	HE135214BL	90	100	7	82,00	515 x 600 x 1000	1.245,00
761000968	HE135215BL	90	100	8	88,00	515 x 600 x 1000	1.349,00
761000969	HE135216BL	90	100	9	93,00	515 x 600 x 1000	1.439,00
761000970	HE135217BL	90	100	9	93,00	515 x 600 x 1000	1.439,00
761000971	HE135218BL	90	100	11	103,00	515 x 600 x 1000	1.609,00
761000972	HE135219BL	90	100	12	108,00	515 x 600 x 1000	1.699,00
761001976	HE135411BL	90	100	7	98,00	515 x 600 x 1400	1.389,00
761001977	HE135412BL	90	100	7	98,00	515 x 600 x 1400	1.389,00
761001978	HE135413BL	90	100	8	104,00	515 x 600 x 1400	1.485,00
761001979	HE135414BL	90	100	8	104,00	515 x 600 x 1400	1.485,00
761001980	HE135415BL	90	100	10	114,00	515 x 600 x 1400	1.665,00
761001981	HE135416BL	90	100	10	114,50	515 x 600 x 1400	1.665,00
761001982	HE135417BL	90	100	11	120,00	515 x 600 x 1400	1.749,00
761001983	HE135418BL	90	100	12	125,00	515 x 600 x 1400	1.849,00
761001984	HE135419BL	90	100	12	131,00	515 x 600 x 1400	1.939,00



ONDERVERDELINGEN
p. 558

OOK IN ANDERE KLEUREN BESCHIKBAAR
ORIG-NR MET EXTENSIE GR
ORIG-NR MET EXTENSIE RL



EQUIPMENT



• Plaatdikte 10/10 mm

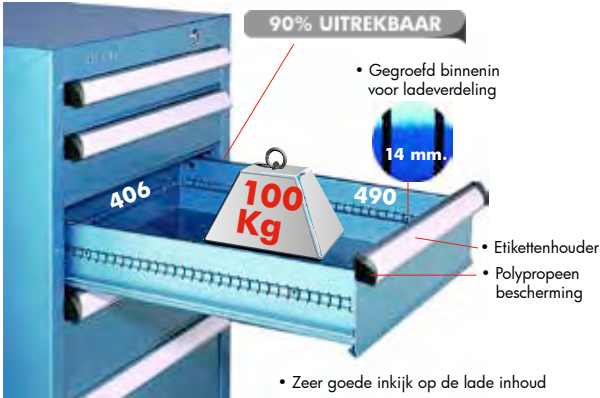

• Centrale vergrendeling



• Anti-omkeermechanisme

EQUIPMENT



OOK IN ANDERE KLEUREN BESCHIKBAAR
 ORIG. NR. MET EXTENSIE GR
 ORIG. NR. MET EXTENSIE RL

Ladenkasten in zeer stabiele en zware uitvoering, geschikt voor intensief en industrieel gebruik. Constructie in plaatstaal 10/10mm met een poederlak coating in lichte hamerslag uitvoering.

- laden 90% uittrekbaar met een draagvermogen van 100kg
- breedte 555mm, diepte 600mm en hoogte 825mm
- centrale vergrendeling met een cilinderslot (+2 sleutels)
- zeer hoogwaardige lagergeleidingen
- 1-lade uittrekbeveiliging voorkomt omkantelen
- verschillende compartimenten en lade-indelingen mogelijk

Order nr.	Orig. nr.	Gewicht kg	Afmetingen (l x b x h) mm	Prijs €
761001988	HE13621BL	62,00	600 x 515 x 825	959,00
761001989	HE13622BL	67,00	600 x 515 x 825	1.059,00



OOK IN ANDERE KLEUREN BESCHIKBAAR
 ORIG-NR MET EXTENSIE GR
 ORIG-NR MET EXTENSIE RL



HE127

Ladenkasten met deuren in zeer stabiele en zware uitvoering, geschikt voor intensief en industrieel gebruik. Constructie in plaatstaal 10/10mm met een poederlak coating in lichte hamerslag uitvoering.

- laden 100% uittrekbaar met een draagvermogen van 100kg
- breedte 714mm, diepte 707mm en 2 hoogtes (1000 en 1400mm)
- deurhoogte 600mm, 675mm of 900mm
- centrale vergrendeling met een cilinderslot (+2 sleutels)
- zeer hoogwaardige lagergeleidingen
- 1-lade uittrekbeveiliging voorkomt omkantelen
- verschillende compartimenten en lade-indelingen mogelijk

Order nr.	Orig. nr.	Aantal laden	Open ruimte mm	Gewicht kg	Afmetingen (l x b x h) mm	Prijs €
761000879	HE12731BL	3	600	77,50	714 x 730 x 1000	1.149,00
761000886	HE12741BL	4	900	97,50	714 x 730 x 1400	1.535,00
761000893	HE12751BL	5	675	112,00	714 x 730 x 1400	1.279,00
761000900	HE12761BL	6	600	121,00	714 x 730 x 1400	1.895,00
761000901	HE12762BL	6	600	138,00	714 x 730 x 1400	2.079,00
761000894	HE12752BL	5	675	129,00	714 x 730 x 1400	1.469,00
761000887	HE12742BL	4	900	114,50	714 x 730 x 1400	1.719,00
761000880	HE12732BL	3	600	97,50	714 x 730 x 1000	1.339,00
761000902	HE12763BL	6	600	144,50	714 x 730 x 1400	2.049,00
761000895	HE12753BL	5	675	135,50	714 x 730 x 1400	1.449,00
761000888	HE12743BL	4	900	146,00	714 x 730 x 1400	1.905,00
761000881	HE12733BL	3	600	104,00	714 x 730 x 1000	1.319,00
761000903	HE12764BL	6	600	153,00	714 x 730 x 1400	2.149,00
761000896	HE12754BL	5	675	144,00	714 x 730 x 1400	1.515,00
761000889	HE12744BL	4	900	129,50	714 x 730 x 1400	1.795,00
761000882	HE12734BL	3	600	112,50	714 x 730 x 1000	1.419,00
761000904	HE12765BL	6	600	154,50	714 x 730 x 1400	2.355,00
761000897	HE12755BL	5	675	145,50	714 x 730 x 1400	1.719,00
761000890	HE12745BL	4	900	127,50	714 x 730 x 1400	1.999,00
761000883	HE12735BL	3	600	110,50	714 x 730 x 1000	1.575,00
761000905	HE12766BL	6	600	171,00	714 x 730 x 1400	2.605,00
761000898	HE12756BL	5	675	162,00	714 x 730 x 1400	1.969,00
761000891	HE12746BL	4	900	147,50	714 x 730 x 1400	2.245,00
761000884	HE12736BL	3	600	123,50	714 x 730 x 1000	1.849,00



HE10641

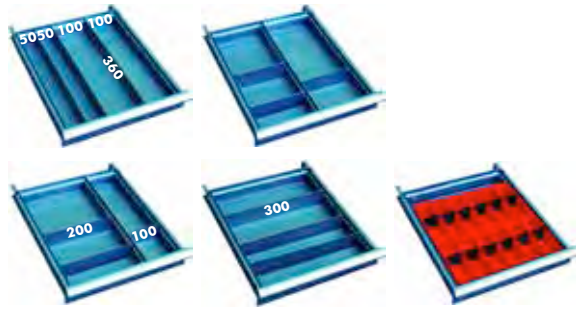

HE10642

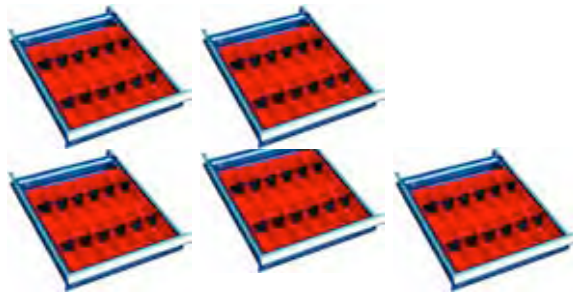

HE10643

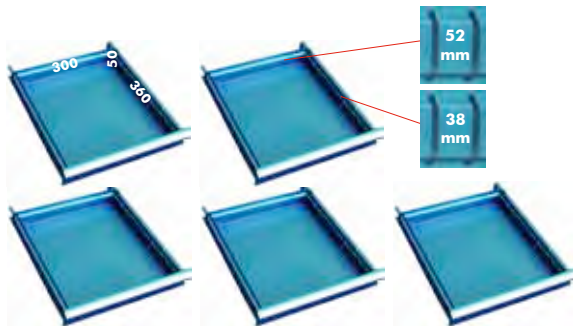

HE10644



EQUIPMENT

Ladenkasten in zeer stabiele en zware uitvoering geschikt voor intensief en industrieel gebruik. Constructie in plaatstaal 8/10mm met een poederlak coating in lichte hamerslag uitvoering.

- breedte 370mm, hoogte 360mm en diepte 420mm
- zeer hoogwaardige geleidingen
- verschillende compartimenten en lade-indelingen mogelijk

Order nr.	Orig. nr.	Gewicht kg	Afmetingen (l x b x h) mm	Prijs €
761000067	HE10641BL	19,84	370 x 420 x 360	320,00
761000068	HE10642BL	20,56	370 x 420 x 360	337,00
761000069	HE10643BL	17,70	370 x 420 x 360	265,00
761000070	HE10644BL	18,40	370 x 420 x 360	305,00



Ladenkasten in zeer stabiele en zware uitvoering, geschikt voor intensief en industrieel gebruik. Constructie in plaatstaal 10/10mm en 15/10mm (laden) met een poederlak coating in lichte hamerslag uitvoering.

- laden 90% uittrekbaar met een draagvermogen van 100kg
- breedte 714mm, diepte 600mm, hoogte 700mm
- centrale vergrendeling met een cilinderslot (+2 sleutels)
- zeer hoogwaardige lagergeleidingen
- 1-lade uittrekbeveiliging voorkomt omkantelen
- verschillende compartimenten en lade-indelingen mogelijk

Order nr.	Orig. nr.	Uittrekbaar	Capaciteit lades	Aantal laden	Kleur	Gewicht	Afmetingen (l x b x h)	Prijs
		%	kg			kg	mm	€
761011950	HE122111GR	90	100	3	grijs	54,50	714 x 600 x 700	829,00
761011951	HE122112GR	90	100	4	grijs	61,00	714 x 600 x 700	929,00
761011952	HE122113GR	90	100	4	grijs	61,00	714 x 600 x 700	939,00
761011953	HE122114GR	90	100	4	grijs	61,00	714 x 600 x 700	929,00



Kunststof bakjes voor lades en tussenschotten.

Order nr.	Orig. nr.	Gewicht kg	Afmetingen (l x b x h) mm	Prijs €
761001745	HECPA00	5,00	100 x 50 x 50	1,20
761001746	HECPA01	5,00	150 x 50 x 47	0,80
761001748	HECPA02	5,00	100 x 100 x 50	1,30
761001749	HECPA03	5,00	75 x 75 x 50	2,30
761001750	HECPA04	5,00	150 x 75 x 50	2,50
761001751	HECPA05	5,00	150 x 150 x 50	2,70
761001752	HECPA06	5,00	120 x 60 x 50	1,40
761001753	HECPA07	5,00	120 x 120 x 50	1,20
761001762	HECPC03	5,00	75 x 75 x 71	3,30
761001763	HECPC04	5,00	150 x 75 x 71	3,60
761001764	HECPC05	5,00	150 x 150 x 71	3,80



Freezshouder in kunstof. Hoogte 25mm.

Order nr.	Orig. nr.	Diameter mm	Gewicht kg	Prijs €
761001773	HEPFA13	13	5,00	6,10
761001774	HEPFA16	16	5,00	6,10
761001775	HEPFA22	22	5,00	1,20
761001776	HEPFA27	13	5,00	6,20
761001777	HEPFA32	32	5,00	6,20
761001778	HEPFA40	40	5,00	6,20
761001779	HEPFA50	50	5,00	6,30



Gereedschapshouder 6 onderverdelingen. Tot 20 mm. 150x30x28 of 150x65x28.

Order nr.	Orig. nr.	Gewicht kg	Prijs €
	761001780		
Orig. nr.	HEPHA06		
Gewicht	kg	5,00	
Prijs	€	8,90	



Gereedschapshouder 8 onderverdelingen. Tot 14 mm. 150x30x28 of 150x65x28.

Order nr.	Orig. nr.	Gewicht kg	Prijs €
	761001781		
Orig. nr.	HEPHA08		
Gewicht	kg	5,00	
Prijs	€	9,80	



Gereedschapshouder 11 onderverdelingen. Tot 8 mm. 150x30x28 of 150x65x28.

Order nr.	Orig. nr.	Gewicht kg	Prijs €
	761001782		
Orig. nr.	HEPHA11		
Gewicht	kg	5,00	
Prijs	€	14,90	



Universeel opdeelvak 2-delig.

Order nr.	Orig. nr.	Gewicht kg	Prijs €
	761001785		
Orig. nr.	HECPA10		
Gewicht	kg	5,00	
Prijs	€	14,90	



Tussenschot voor HECPA10.

Order nr.	Orig. nr.	Gewicht kg	Prijs €
	761001757		
Orig. nr.	HECPA101		
Gewicht	kg	5,00	
Prijs	€	2,30	

HECO



Universeel opdeelvak 3-delig.

Order nr.	761001758 €
Orig. nr.	HECPA11
Gewicht	kg 5,00
Prijs	€ 14,90

HECO



Tussenschot voor HECPA11.

Order nr.	761001759 €
Orig. nr.	HECPA111
Gewicht	kg 5,00
Prijs	€ 1,80

HECO



Universeel opdeelvak 4-delig.

Order nr.	761001760 €
Orig. nr.	HECPA12
Gewicht	kg 5,00
Prijs	€ 14,90

HECO



Tussenschot voor HECPA12.

Order nr.	761001761 €
Orig. nr.	HECPA121
Gewicht	kg 5,00
Prijs	€ 1,40

HECO

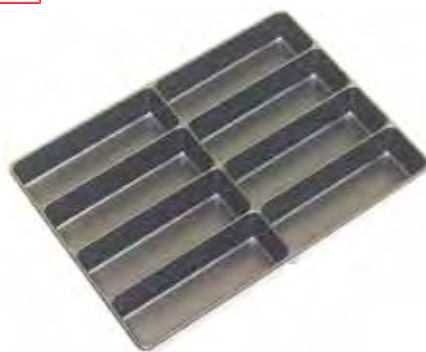

HEMPO1



HEMPO2



HEMPO3



HEMPO4



HEMPO5

Ladeonderverdelingen in ABS. Langs- en dwarschotten. Leverbaar met 5, 6, 8, 10, 12 of 20 onderverdelingen.

Order nr.	Orig. nr.	Aantal afdelingen	Gewicht	Afmetingen (l x b x h)	Prijs €
			kg	mm	
761001765 €	HEMPO1	8	0,50	410 x 300 x 0	33,50
761001766 €	HEMPO2	10	0,50	410 x 300 x 0	33,50
761001767 €	HEMPO3	5	0,50	410 x 300 x 0	33,50
761001768 €	HEMPO4	12	0,50	410 x 300 x 0	33,50
761001769 €	HEMPO5	6	0,50	410 x 300 x 0	33,50
761001770 €	HEMPO6	20	0,50	410 x 300 x 0	33,50

EQUIPMENT

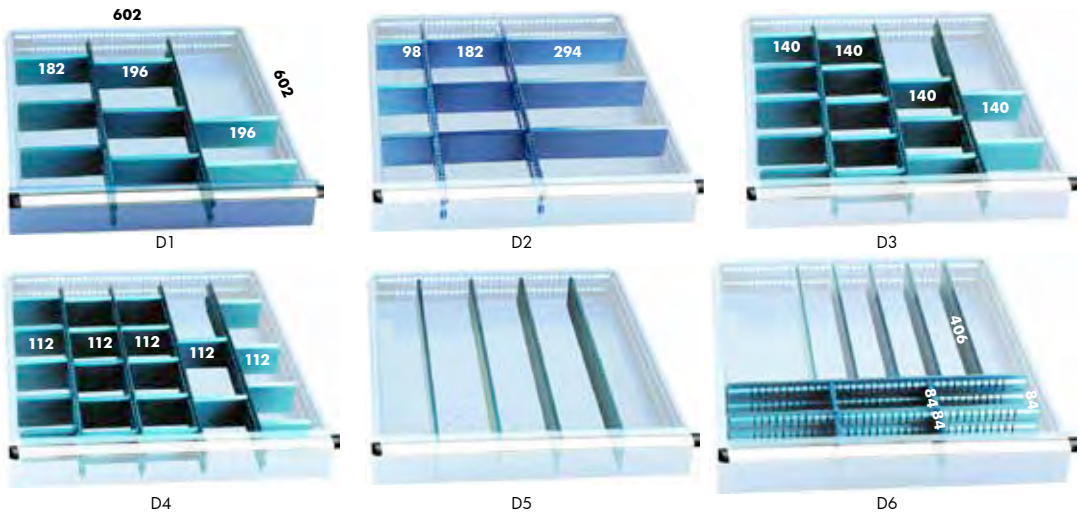

Opdeling lade 600mm voor serie HE115 met breedte 714mm, diepte 707mm. Langs- en dwarschotten. In gepoederlakt staal. Leverbaar in verschillende hoogtes : 50, 100, 150, 200 en 250mm.

Order nr.	Orig. nr.	Type	Hoogte mm	Gewicht kg	Prijs €
761000299	HE115050D1BL	D1	50	1,86	45,50
761000309	HE115075D1BL	D1	75	2,50	42,90
761000316	HE115100D1BL	D1	100	2,93	52,50
761000346	HE115125D1BL	D1	125	3,82	58,90
761000365	HE115150D1BL	D1	150	4,42	60,90
761000374	HE115200D1BL	D1	200	6,04	71,90
761000416	HE115250D1BL	D1	250	7,46	81,50
761000300	HE115050D2BL	D2	50	1,94	52,50
761000310	HE115075D2BL	D2	75	2,63	42,90
761000317	HE115100D2BL	D2	100	3,09	52,50
761000347	HE115125D2BL	D2	125	4,03	58,90
761000366	HE115150D2BL	D2	150	4,46	62,50
761000375	HE115200D2BL	D2	200	6,41	75,90
761000417	HE115250D2BL	D2	250	8,62	94,90
761000301	HE115050D3BL	D3	50	2,27	64,50
761000311	HE115075D3BL	D3	75	3,08	60,90
761000318	HE115100D3BL	D3	100	3,84	64,50
761000348	HE115125D3BL	D3	125	5,05	77,50
761000367	HE115150D3BL	D3	150	5,95	104,00
761000376	HE115200D3BL	D3	200	8,51	137,00
761000418	HE115250D3BL	D3	250	10,34	139,00
761000302	HE115050D4BL	D4	50	2,57	113,00
761000312	HE115075D4BL	D4	75	3,53	75,90
761000319	HE115100D4BL	D4	100	4,47	109,00
761000349	HE115125D4BL	D4	125	6,00	98,50
761000368	HE115150D4BL	D4	150	6,93	112,00
761000377	HE115200D4BL	D4	200	10,93	141,00
761000419	HE115250D4BL	D4	250	12,35	164,00
761000303	HE115050D5BL	D5	50	1,76	21,50
761000313	HE115075D5BL	D5	75	2,25	29,50
761000320	HE115100D5BL	D5	100	2,69	31,90
761000350	HE115125D5BL	D5	125	3,63	34,90
761000369	HE115150D5BL	D5	150	3,95	39,50
761000378	HE115200D5BL	D5	200	5,71	47,90
761000420	HE115250D5BL	D5	250	7,04	60,90
761000304	HE115050D6BL	D6	50	2,01	50,50
761000314	HE115075D6BL	D6	75	2,96	47,90
761000321	HE115100D6BL	D6	100	3,68	56,50
761000351	HE115125D6BL	D6	125	4,68	63,50
761000370	HE115150D6BL	D6	150	6,34	68,50
761000379	HE115200D6BL	D6	200	7,83	84,90
761000421	HE115250D6BL	D6	250	9,85	104,00

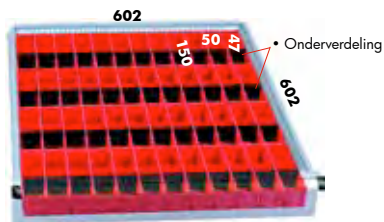

HE115075C1

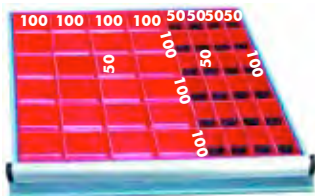

HE115075C2

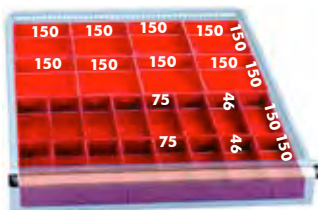

HE115075C3

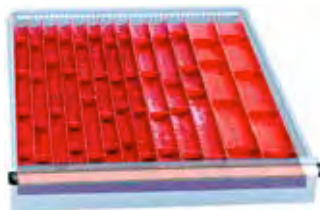

HE115075C4

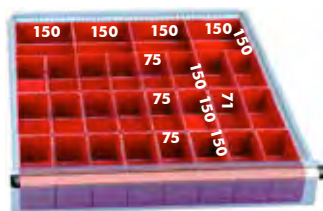

HE115125C1

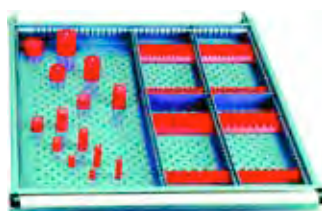

Toepassing

Opdeling bakjes 600mm serie voor ladenkasten breedte 714 mm x diepte 707mm.

Order nr.	Orig. nr.	Hoogte mm	Gewicht kg	Prijs €
761000305	HE115075C1	75/100	2,99	64,50
761000306	HE115075C2	75/100	0,01	75,90
761000307	HE115075C3	75/100	0,01	224,00
761000308	HE115075C4	75/100	0,01	217,00
761000345	HE115125C1BL	125/150	0,01	319,00

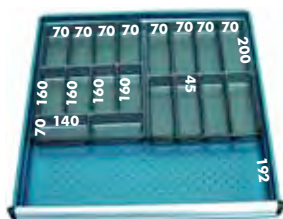

HE115MP01-02

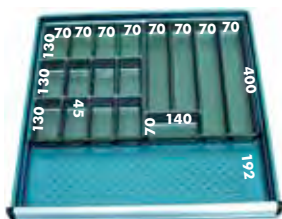

HE115MP03-04

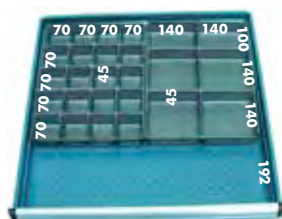

HE115MP05-06

Compactbakjes met onderverdelingen voor ladenkasten breedte 714mm x diepte 707mm. Van slagvaste ABS-kunststof. Onderverdeling per 15mm in grijs polystyrol. PS tray.

Order nr.	Orig. nr.	Hoogte mm	Breedte PS tray mm	Gewicht kg	Prijs €
761000481	HE115MP01-02	75/100	560	0,01	78,50
761000482	HE115MP03-04	75/100	560	0,01	78,50
761000483	HE115MP05-06	75/100	560	0,01	78,50

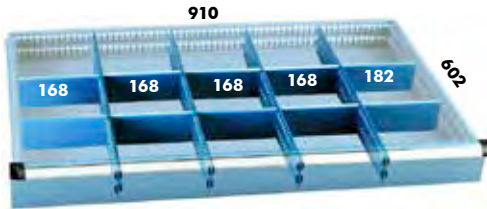

D3

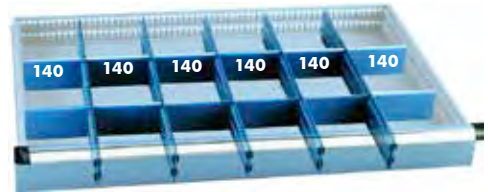

D4

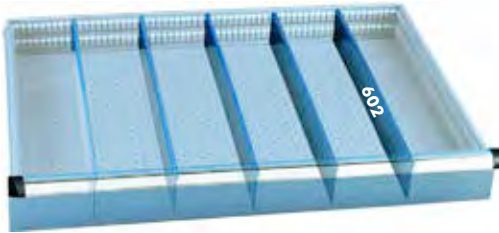

D5



D6

EQUIPMENT

Opdeling lade 910mm voor serie HE119 met breedte 1020mm, diepte 707mm. Langs- en dwarschotten. In gepoederlakt staal. Leverbaar in verschillende hoogtes : 50, 100, 150, 200 en 250mm.

Order nr.	Orig. nr.	Type	Hoogte mm	Gewicht kg	Prijs €
761000550	HE119050D3BL	D3	50	2,31	66,50
761000554	HE119075D3BL	D3	75	3,16	60,90
761000559	HE119100D3BL	D3	100	3,92	69,90
761000577	HE119125D3BL	D3	125	5,42	73,90
761000594	HE119150D3BL	D3	150	6,03	83,90
761000600	HE119200D3BL	D3	200	9,11	107,00
761000631	HE119250D3BL	D3	250	10,49	130,00
761000551	HE119050D4BL	D4	50	2,51	77,50
761000555	HE119075D4BL	D4	75	3,38	68,50
761000560	HE119100D4BL	D4	100	4,36	78,50
761000578	HE119125D4BL	D4	125	5,78	88,50
761000595	HE119150D4BL	D4	150	6,74	96,90
761000601	HE119200D4BL	D4	200	9,53	128,00
761000632	HE119250D4BL	D4	250	11,74	139,00
761000552	HE119050D5BL	D5	50	1,97	24,90
761000556	HE119075D5BL	D5	75	2,59	35,90
761000561	HE119100D5BL	D5	100	3,15	38,50
761000579	HE119125D5BL	D5	125	4,28	40,90
761000596	HE119150D5BL	D5	150	4,72	47,90
761000602	HE119200D5BL	D5	200	6,91	57,90
761000633	HE119250D5BL	D5	250	8,58	68,50
761000553	HE119050D6BL	D6	50	2,95	107,00
761000557	HE119075D6BL	D6	75	3,94	92,90
761000562	HE119100D6BL	D6	100	5,20	100,00
761000580	HE119125D6BL	D6	125	7,03	121,00
761000597	HE119150D6BL	D6	150	8,04	128,00
761000603	HE119200D6BL	D6	200	11,69	147,00
761000634	HE119250D6BL	D6	250	14,20	177,00

HECO

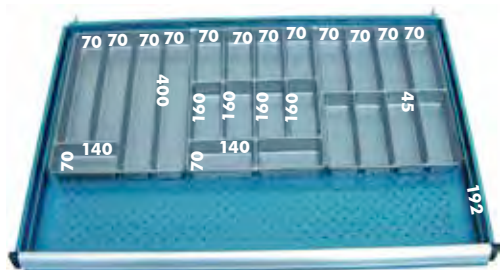

HE119MP01-02-03

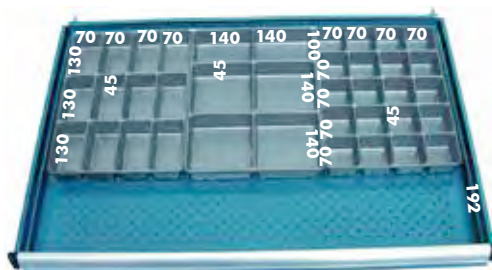

HE119MP04-05-06

Compactbakjes met onderverdelingen voor serie HE119 met breedte 1020mm, diepte 707mm. Van slagvaste ABS-kunststof. Onderverdeling per 15mm. Onderverdelingbakje per 15mm in grijs polystyrol. (tray). PS tray.

Order nr.	Orig. nr.	Hoogte mm	Breedte PS tray mm	Gewicht kg	Prijs €
761000681	HE119MP01-02-03	75/100	840	0,01	110,00
761000682	HE119MP04-05-06	75/100	840	0,01	110,00

EQUIPMENT

HECO

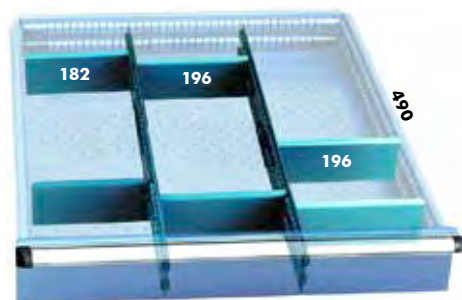

D1

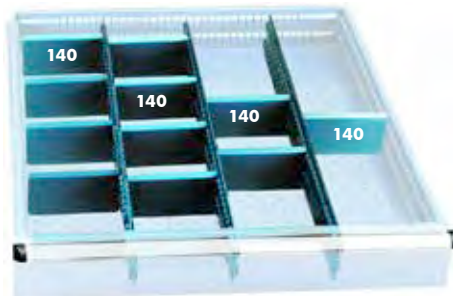

D2

Opdeling lade 602mm voor serie HE122 kasten breedte 714mm x diepte 600mm. Langs- en dwarschotten. In gepoederlakt staal. Leverbaar in verschillende hoogtes 75, 100, 125, 150, 200 en 250mm.

Order nr.	Orig. nr.	Type	Hoogte mm	Gewicht kg	Prijs €
761000734	HE122075D1BL	D1	75	2,12	35,90
761000736	HE122100D1BL	D1	100	2,42	44,50
761000738	HE122125D1BL	D1	125	3,03	47,90
761000740	HE122150D1BL	D1	150	3,59	50,50
761000743	HE122200D1BL	D1	200	4,88	59,90
761000754	HE122250D1BL	D1	250	5,89	69,90
761000735	HE122075D2BL	D2	75	2,57	52,50
761000737	HE122100D2BL	D2	100	3,07	64,50
761000739	HE122125D2BL	D2	125	3,89	62,50
761000741	HE122150D2BL	D2	150	4,70	68,50
761000744	HE122200D2BL	D2	200	6,61	84,90
761000755	HE122250D2BL	D2	250	8,01	104,00

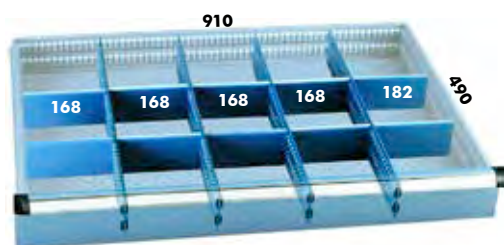

D1



D2

Opdeling lade 910mm voor serie HE123 met breedte 1020mm, diepte 600mm. Langs- en dwarschotten. Van gepoederlakt staal. Leverbaar in verschillende hoogtes 75, 100, 125, 150, 200 en 250mm.

Order nr.	Orig. nr.	Type	Hoogte mm	Gewicht kg	Prijs €
761000773	HE123075D1BL	D1	75	2,95	55,90
761000775	HE123100D1BL	D1	100	3,49	64,50
761000777	HE123125D1BL	D1	125	4,74	68,50
761000779	HE123150D1BL	D1	150	5,43	77,50
761000782	HE123200D1BL	D1	200	8,27	107,00
761000793	HE123250D1BL	D1	250	9,41	130,00
761000774	HE123075D2BL	D2	75	3,57	80,50
761000776	HE123100D2BL	D2	100	4,45	92,90
761000778	HE123125D2BL	D2	125	5,79	110,00
761000780	HE123150D2BL	D2	150	6,96	114,00
761000783	HE123200D2BL	D2	200	10,18	147,00
761000794	HE123250D2BL	D2	250	12,34	177,00

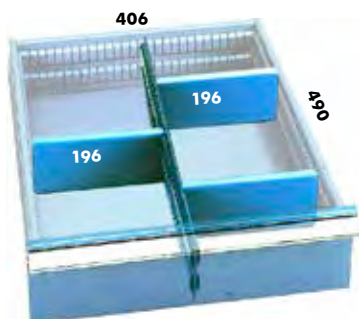

D1

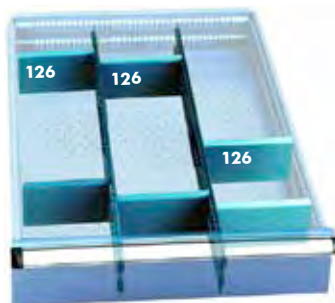

D2

Opdeling lade 406mm voor serie HE135 met breedte 515mm, diepte 600mm. Langs- en dwarschotten. In gepoederlakt staal. Leverbaar in verschillende hoogtes 75, 100, 125, 150, 200 en 250mm.

Order nr.	Orig. nr.	Type	Hoogte mm	Gewicht kg	Prijs €
761000936	HE135075D1BL	D1	75	1,48	15,90
761000941	HE135100D1BL	D1	100	1,67	17,50
761000953	HE135125D1BL	D1	125	1,97	21,50
761000956	HE135150D1BL	D1	150	2,26	21,50
761000961	HE135200D1BL	D1	200	2,89	25,90
761000973	HE135250D1BL	D1	250	3,45	33,50
761000937	HE135075D2BL	D2	75	1,83	25,90
761000942	HE135100D2BL	D2	100	2,13	30,90
761000954	HE135125D2BL	D2	125	2,61	34,90
761000957	HE135150D2BL	D2	150	3,14	39,50
761000962	HE135200D2BL	D2	200	4,60	46,90
761000974	HE135250D2BL	D2	250	5,01	63,50

Heco muurkasten



HECO



HE145 20 + 136 20 C2

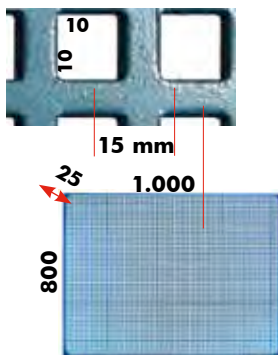

HE14510



HE145101

EQUIPMENT

OPTIONELE HAKEN
p. 575



HE14513



HE145131



HE14515



HE145151

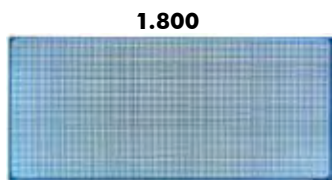

HE14518



HE145181



HE14520



HE145201

Wandplaat met geperforeerde achterwand. Staalplaatconstructie in blauwe hamerslagcoating.

- diepte en hoogte : 25/800mm
- leverbaar in breedte 1000, 1300, 1500, 1800 en 2000mm
- geleverd zonder haken en gereedschapshouders

Order nr.	Orig. nr.	Perforatie mm	Hart-op-hart afstand mm	Gewicht kg	Afmetingen (l x b x h) mm	Prijs €
761001106	HE14510BL	10x10	15x15	9,56	1000 x 800 x 25	106,00
761001109	HE14513BL	10x10	15x15	12,00	1300 x 800 x 25	129,00
761001111	HE14515BL	10x10	15x15	13,20	1500 x 800 x 25	148,00
761001113	HE14518BL	10x10	15x15	16,50	1800 x 800 x 25	157,00
761001115	HE14520BL	10x10	15x15	19,10	2000 x 800 x 25	174,00

HECO



HE11215 + 14515C + HE145CTP + HEV-BULL1 + HEV-BULL2



ACCESSOIRES

p. 578

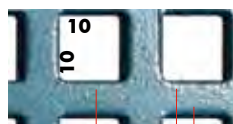

15 mm

1.300

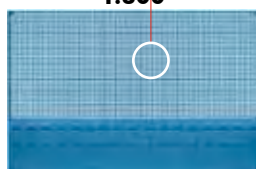

HE14513C



HE145131

OPTIONELE HAKEN

p. 575

EQUIPMENT

1.000

800

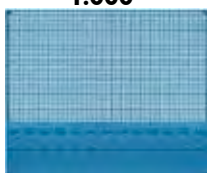

HE14510C



HE145101

1.800



HE14518C



HE145181

1.500



HE14515C



HE145151

2.000



HE14520C



HE145201

Wandplaat met geperforeerde achterwand en bakjes steun. Perforatie met 10/10mm vierkant profiel. Staalplaatconstructie in blauwe hamerslagcoating.

- diepte en hoogte 15/800mm
- leverbaar in breedte 1000, 1300, 1500, 1800 en 2000mm
- geleverd zonder haken en gereedschapshouders

Order nr.	Orig. nr.	Gewicht kg	Afmetingen (l x b x h) mm	Prijs €
761001995	HE14510CBL	9,56	1000 x 800 x 25	125,00
761001996	HE14513CBL	12,00	1300 x 800 x 25	146,00
761001997	HE14515CBL	13,20	1500 x 800 x 25	156,00
761001998	HE14518CBL	16,50	1800 x 800 x 25	175,00
761001999	HE14520CBL	19,10	2000 x 800 x 25	198,00



EQUIPMENT



OPTIONELE HAKEN
p. 575

OOK IN ANDERE KLEUREN BESCHIKBAAR
■ ORIG. NR. MET EXTENSIE GR
■ ORIG. NR. MET EXTENSIE RL

HE110184 + HE13618M11 + HE1350

Wandkast met geperforeerde achterwand met afsluitbaar rolgordijn in metaalplaat. Perforatie met 10/10mm vierkant profiel. Staalplaatconstructie in blauwe hamerslagcoating.

- type extra plat
- diepte en hoogte 170/900mm
- leverbaar in breedte 1000, 1300, 1500, 1800 en 2000mm
- geleverd zonder haken en gereedschapshouders
- metalen rolgordijn met terugslagmechanisme
- afsluitbaar met sleutel

Order nr.	Orig. nr.	Gewicht kg	Afmetingen (l x b x h) mm	Prijs €
761000116	HE110104BL	36,50	1000 x 900 x 170	386,00
761000118	HE110134BL	51,00	1300 x 900 x 170	439,00
761000120	HE110154BL	64,80	1500 x 900 x 170	447,00
761000122	HE110184BL	66,50	1800 x 900 x 170	509,00
761000124	HE110204BL	72,00	2000 x 900 x 170	535,00

1.000



HE110104

ACCESSOIRES

p. 578



HE145101



- Ook verkrijgbaar in gezeefdrukte afbeeldingen van gereedschappen (HE109 + HE110) zie www.vynckier.biz

1.300



HE110134

1.500



HE110154



HE145131



HE145151

1.800

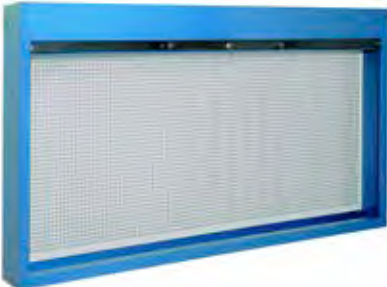

HE110184

2.000

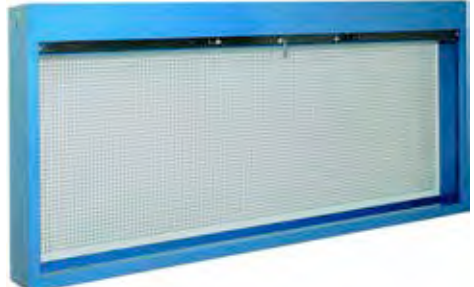

HE110204



HE145181

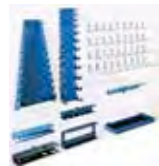

HE145201

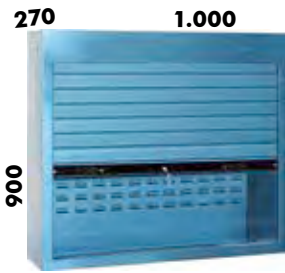

HE11010C



HE11013C

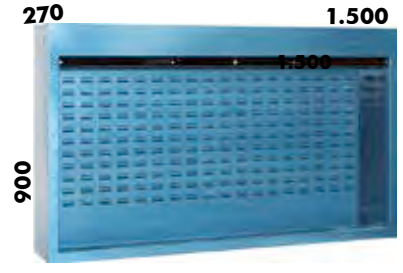

HE11015C



HE11010C1



HE11013C1



HE11015C1



HE11010C2



HE11013C2



HE11015C2

EQUIPMENT

Wandkast met geperforeerde achterwand voor bakjes V-BULL 1, 2 en 3. Met afsluitbaar rolgordijn in metaalplaat. Perforatie met 10/10mm vierkant profiel. Staalplaatconstructie in blauwe hamerslagcoating.

- diepte en hoogte 270/900mm
- leverbaar in breedte 1000, 1300, 1500, 1800 en 2000mm
- metalen rolgordijn met terugslagmechanisme
- afsluitbaar met sleutel

Order nr.	Orig. nr.	Bakjes	Gewicht kg	Afmetingen (l x b x h) mm	Prijs €
761001841	HE11010CBL	-	31,00	1000 x 270 x 900	405,00
761001842	HE11010C1BL	18x0,4L+18x1,2L+18x3,5L	38,00	1000 x 270 x 900	515,00
761001843	HE11010C2BL	22x0,4L+18x1,2L+18x3,5L	38,00	1000 x 270 x 900	525,00
761001844	HE11013CBL	-	38,50	1300 x 270 x 900	461,00
761001845	HE11013C1BL	24x0,4L+24x1,2L+24x3,5L	48,00	1300 x 270 x 900	615,00
761001846	HE11013C2BL	22x0,4L+36x1,2L+20x3,5L	48,00	1300 x 270 x 900	619,00
761001847	HE11015CBL	-	43,00	1500 x 270 x 900	475,00
761001848	HE11015C1BL	28x0,4L+28x1,2L+30x3,5L	54,00	1500 x 270 x 900	659,00
761001849	HE11015C2BL	33x0,4L+30x1,2L+26x3,5L	53,50	1500 x 270 x 900	645,00
761001850	HE11018CBL	-	50,00	1800 x 270 x 900	545,00
761001851	HE11018C1BL	34x0,4L+34x1,2L+36x3,5L	63,00	1800 x 270 x 900	759,00
761001852	HE11018C2BL	33x0,4L+42x1,2L+32x3,5L	63,00	1800 x 270 x 900	755,00
761001853	HE11020CBL	-	53,00	2000 x 270 x 900	555,00
761001854	HE11020C1BL	38x0,4L+38x1,2L+39x3,5L	68,00	2000 x 270 x 900	789,00
761001855	HE11020C2BL	33x0,4L+36x1,2L+41x3,5L	68,00	2000 x 270 x 900	795,00



HE11018C



HE11020C



HE11018C1



HE11020C1



HE11018C2



HE11020C2

EQUIPMENT

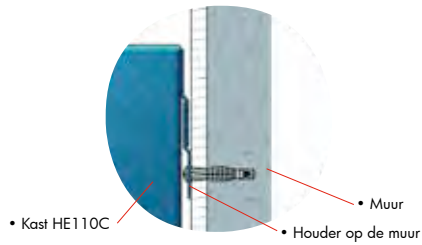
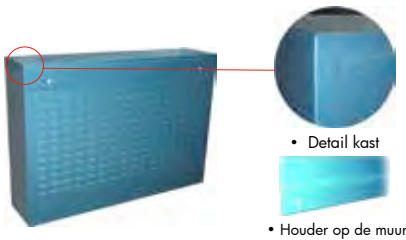

HEV-BULL1



HEV-BULL2



HEV-BULL3

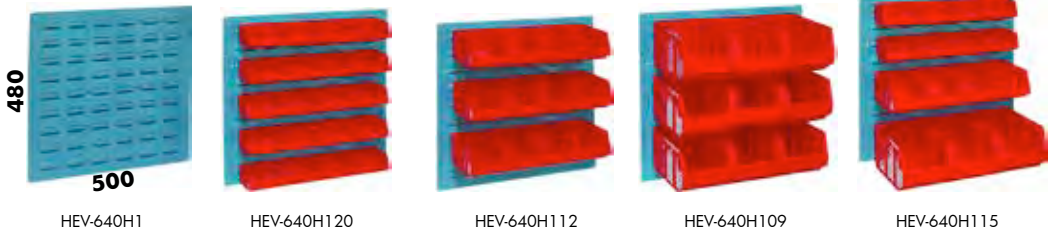

HEV-640H1

HEV-640H120

HEV-640H112

HEV-640H109

HEV-640H115

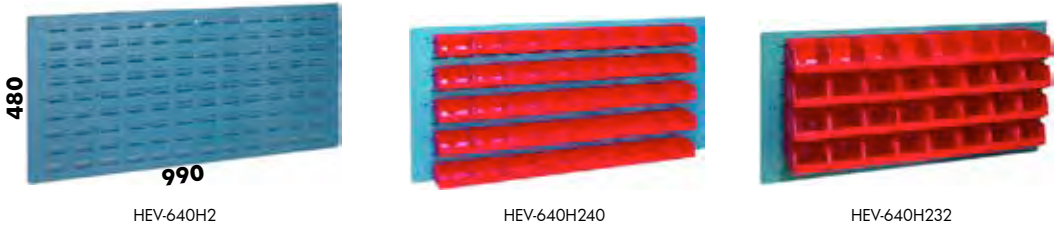

HEV-640H2

HEV-640H240

HEV-640H232



HEV-640H218

HEV-640H230

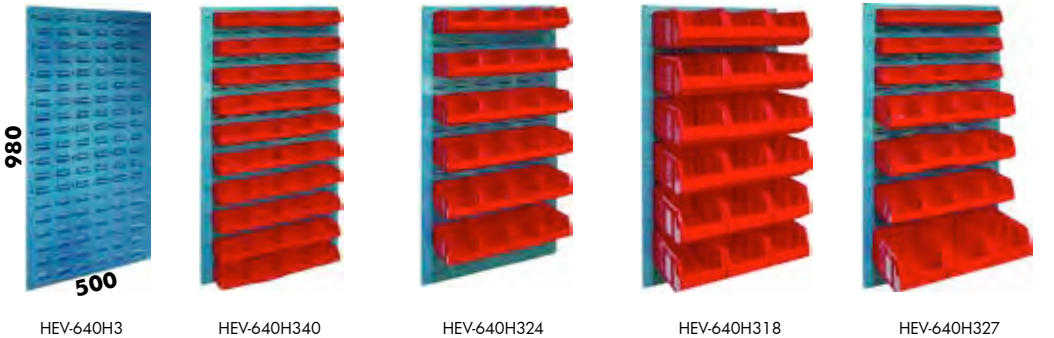

HEV-640H3

HEV-640H340

HEV-640H324

HEV-640H318

HEV-640H327

EQUIPMENT

Metalen wandpaneel type V-640H voor bakjes V-BULL 1, 2 en 3. Staalplaat 12/10mm.

Order nr.	Orig. nr.	Bakjes	Diepte mm	Gewicht kg	Afmetingen (l x b x h) mm	Prijs €
761001808	HEV-640H1BL	-	-	3,00	500 x 480 x 0	31,90
761001812	HEV-640H120BL	20x0,4L	100	3,92	500 x 480 x 0	50,50
761001810	HEV-640H112BL	12x1,2L	180	4,40	500 x 480 x 0	55,50
761001809	HEV-640H109BL	9x3,5L	250	5,10	500 x 480 x 0	66,50
761001811	HEV-640H115BL	8x0,4L+4x1,2L+3x3,5L	250	4,50	500 x 480 x 0	59,90
761001813	HEV-640H2BL	-	-	10,00	990 x 480 x 0	48,90
761001817	HEV-640H240BL	40x0,4L	100	7,00	990 x 480 x 0	78,50
761001816	HEV-640H232BL	32x1,2L	180	9,00	990 x 480 x 0	104,00
761001814	HEV-640H218BL	18x3,5L	250	9,50	990 x 480 x 0	116,00
761001815	HEV-640H230BL	8x0,4L+16x1,2L+6x3,5L	250	9,00	990 x 480 x 0	106,00
761001818	HEV-640H3BL	-	-	10,00	500 x 980 x 0	50,50
761001822	HEV-640H340BL	40x0,4L	100	7,00	500 x 980 x 0	80,50
761001820	HEV-640H324BL	24x1,2L	180	8,00	500 x 980 x 0	90,90
761001819	HEV-640H318BL	18x3,5L	250	9,50	500 x 980 x 0	119,00
761001821	HEV-640H327BL	12x0,4L+12x1,2L+3x3,5L	250	8,00	500 x 980 x 0	90,90

HECO

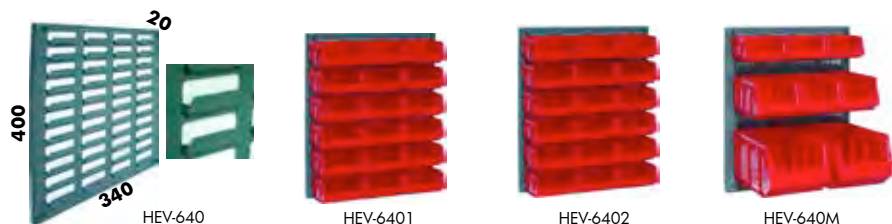

Kunststof wandpaneel geschikt voor bakjes V-BULL 1, 2 en 3.

Order nr.	Orig. nr.	Bakjes	Gewicht kg	Afmetingen (l x b x h) mm	Prijs €
761001805	HEV-640	-	0,20	340 x 20 x 400	9,80
761001806	HEV-6401	18x0,4L	1,10	340 x 20 x 400	25,90
761001807	HEV-6402	12x1,2L	1,50	340 x 20 x 400	33,50
761001823	HEV-640MBL	3x0,4L+3x1,2L+2x3,5L	1,20	340 x 20 x 400	29,50

HECO

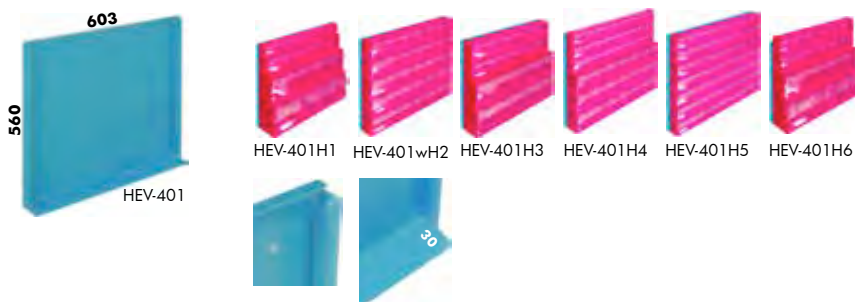

Wandpaneel voor opbergbakjes HEV-FOX 101, 102, 103 en 104.

Order nr.	Orig. nr.	Bakjes	Gewicht kg	Afmetingen (l x b x h) mm	Prijs €
761001783	HEV-401BL	-	11,50	603 x 560 x 0	50,50
761001784	HEV-401H1BL	24	12,43	603 x 560 x 0	190,00
761001785	HEV-401H2BL	22	26,26	603 x 560 x 0	175,00
761001786	HEV-401H3BL	22	11,96	603 x 560 x 0	180,00
761001787	HEV-401H4BL	45	11,19	603 x 560 x 0	177,00
761001788	HEV-401H5BL	63	10,55	603 x 560 x 0	173,00
761001789	HEV-401H6BL	22	12,86	603 x 560 x 0	198,00

HECO



Wandpaneel voor opbergbakjes HEV-FOX 101, 102, 103 en 104.

Order nr.	Orig. nr.	Bakjes	Gewicht kg	Afmetingen (l x b x h) mm	Prijs €
761001790	HEV-402BL	-	14,50	603 x 800 x 0	60,90
761001791	HEV-402H1BL	49	15,21	603 x 800 x 0	245,00
761001792	HEV-402H2BL	72	14,46	603 x 800 x 0	242,00
761001793	HEV-402H3BL	36	15,81	603 x 800 x 0	252,00
761001794	HEV-402H4BL	42	14,86	603 x 800 x 0	236,00
761001795	HEV-402H5BL	25	16,80	603 x 800 x 0	266,00
761001796	HEV-402H6BL	33	16,24	603 x 800 x 0	235,00

OOK IN ANDERE KLEUREN BESCHIKBAAR
 ORIG-NR MET EXTENSIE GR
 ORIG-NR MET EXTENSIE RL

EQUIPMENT

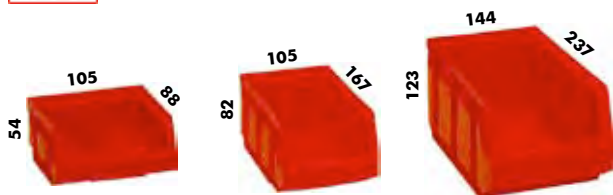

HEV-BULL1

HEV-BULL2

HEV-BULL3



Opbergbakjes.

Order nr.	761003495 €	761003496 €	761003497 €
Orig. nr.	HEV-BULL1	HEV-BULL2	HEV-BULL3
Volume	0,40	1,20	3,50
Capaciteit (op perfwand)	kg 5,00	10,00	15,00
Gewicht	kg 0,46	0,11	0,23
Afmetingen (l x b x h)	mm 105 x 88 x 54	105 x 167 x 82	144 x 237 x 123
Prijs	€ 0,90	2,30	4,80



EQUIPMENT



HEV-940



HEV-9401



HEV-9402



HEV-9403

Kunststof steun, type geschikt voor opbergbakjes V-BULL 1, 2 en 3.

Order nr.	Orig. nr.	Bakjes	Gewicht kg	Afmetingen (l x b x h) mm	Prijs €
761003465 €	HEV-940	-	0,01	415 x 45 x 0	3,70
761003466 €	HEV-9401	4x0,4L	0,01	415 x 45 x 0	8,90
761003467 €	HEV-9402	4x1,2L	0,01	415 x 45 x 0	13,90
761003468 €	HEV-9403	3x3,5L	0,01	415 x 45 x 0	26,90



HE110019



HE110020

Opbergbakjes met houder voor wandpanelen HE144, HE109 en HE110 (hout).

Order nr.	Orig. nr.	Gewicht kg	Prijs €
761000112 €	HE110019BL	0,54	29,50
761000113 €	HE110020BL	0,11	12,90

HECO



Verpakking van 5 haken 45° voor wandpanelen HE110, HE141 en HE145.

Order nr.	761001065 €
Orig. nr.	HE141001
Aantal stuks	5
Lengte	mm 20
Gewicht	kg 0,12
Prijs	€ 8,80

HECO



Verpakking van 5 haken 45° voor wandpanelen HE110, HE141 en HE145.

Order nr.	761001066 €
Orig. nr.	HE141002
Aantal stuks	5
Lengte	mm 40
Gewicht	kg 0,13
Prijs	€ 8,80

HECO



Verpakking van 5 haken 45° voor wandpanelen HE110, HE141 en HE145.

Order nr.	761001067 €
Orig. nr.	HE141003
Aantal stuks	5
Lengte	mm 65
Gewicht	kg 0,15
Prijs	€ 9,80

HECO



Verpakking van 5 haken 45° voor wandpanelen HE110, HE141 en HE145.

Order nr.	761001068 €
Orig. nr.	HE141004
Aantal stuks	5
Lengte	mm 90
Gewicht	kg 0,17
Prijs	€ 11,90

HECO



Verpakking van 5 haken 45° voor wandpanelen HE110, HE141 en HE145.

Order nr.	761001069 €
Orig. nr.	HE141005
Aantal stuks	5
Lengte	mm 20
Gewicht	kg 0,11
Prijs	€ 9,80

HECO



Verpakking van 5 haken 45° voor wandpanelen HE110, HE141 en HE145.

Order nr.	761001070 €
Orig. nr.	HE141006
Aantal stuks	5
Lengte	mm 40
Gewicht	kg 0,13
Prijs	€ 9,80

HECO



Verpakking van 5 haken 45° voor wandpanelen HE110, HE141 en HE145.

Order nr.	761001071 €
Orig. nr.	HE141007
Aantal stuks	5
Lengte	mm 65
Gewicht	kg 0,14
Prijs	€ 11,90

HECO



Verpakking van 5 haken 45° voor wandpanelen HE110, HE141 en HE145.

Order nr.	761001072 €
Orig. nr.	HE141008
Aantal stuks	5
Lengte	mm 90
Gewicht	kg 0,16
Prijs	€ 11,90

HECO



Gereedschapsteunen voor wandpanelen HE110, HE141 en HE145.

Order nr.	Orig. nr.	Aantal stuks	Gewicht kg	Prijs €
761001073	HE141009BL	1	0,42	12,90
761001074	HE141010BL	1	0,42	15,90
761001077	HE141013BL	1	0,06	5,40

HECO



Opbergbakjes met houder voor wandpanelen HE110, HE141 en HE145.

Order nr.	761001075	761001090
Orig. nr.	HE141011BL	HE141026BL
Gewicht	kg 0,12	0,54
Prijs	€ 14,90	26,90

HECO



Gereedschapshaken voor wandpanelen HE110, HE141 en HE145. 5 stuks.

Order nr.	761001097
Orig. nr.	HE144001BL
Aantal stuks	5
Gewicht	kg 0,08
Prijs	€ 17,50

HECO



Gereedschapshaken voor wandpanelen HE110, HE141 en HE145. 5 stuks.

Order nr.	761001098
Orig. nr.	HE144002BL
Aantal stuks	5
Gewicht	kg 0,09
Prijs	€ 11,90

HECO



Gereedschapssteun voor wandpanelen HE110, HE141 en HE145.

Order nr.	761001079
Orig. nr.	HE141015BL
Aantal stuks	1
Gewicht	kg 0,08
Prijs	€ 5,80

HECO



Gereedschapssteun voor wandpanelen HE110, HE141 en HE145.

Order nr.	761001080
Orig. nr.	HE141016BL
Aantal stuks	1
Gewicht	kg 0,06
Prijs	€ 6,10

HECCO



Gereedschapssteun voor wandpanelen HE110, HE141 en HE145.

Order nr.	761001076 €		
Orig. nr.	HE141012BL		
Aantal stuks	1		
Gewicht	kg	0,14	
Prijs	€	7,00	

HECCO



Gereedschapssteun voor wandpanelen HE110, HE141 en HE145.

Order nr.	761001078 €		
Orig. nr.	HE141014BL		
Aantal stuks	1		
Gewicht	kg	0,20	
Prijs	€	7,20	

HECCO



Gereedschapssteun voor wandpanelen HE110, HE141 en HE145.

Order nr.	761001081 €		
Orig. nr.	HE141017BL		
Aantal stuks	1		
Gewicht	kg	0,10	
Prijs	€	6,50	

HECCO



Gereedschapssteunen voor wandpanelen HE110, HE141 en HE145. 2 stuks.

Order nr.	761001089 €		
Orig. nr.	HE141025BL		
Aantal stuks	2		
Gewicht	kg	0,13	
Prijs	€	6,10	

HECCO



Gereedschapssteun voor wandpanelen HE110, HE141 en HE145.

Order nr.	761001087 €		
Orig. nr.	HE141023BL		
Aantal stuks	1		
Gewicht	kg	0,15	
Prijs	€	6,10	

HECCO



Gereedschapssteun voor wandpanelen HE110, HE141 en HE145.

Order nr.	761001088 €		
Orig. nr.	HE141024BL		
Aantal stuks	1		
Gewicht	kg	0,04	
Prijs	€	9,80	

HECCO



Gereedschapssteun voor wandpanelen HE110, HE141 en HE145.

Order nr.	761001086 €		
Orig. nr.	HE141022BL		
Aantal stuks	1		
Gewicht	kg	0,11	
Prijs	€	7,20	

HECCO



Gereedschapssteun voor wandpanelen HE110, HE141 en HE145.

Order nr.	761001085 €		
Orig. nr.	HE141021BL		
Aantal stuks	1		
Gewicht	kg	0,07	
Prijs	€	5,60	

EQUIPMENT



HE145101

HE145131

HE145151

HE145181

HE145201

Ophangset voor wandpanelen HE110, HE141 en HE145.

Order nr.	Orig. nr.	Aantal stuks	Gewicht kg	Prijs €
761001107	HE145101BL	17	2,50	62,50
761001110	HE145131BL	21	3,00	63,50
761001112	HE145151BL	27	3,20	71,90
761001114	HE145181BL	35	3,50	75,90
761001116	HE145201BL	43	4,00	77,50

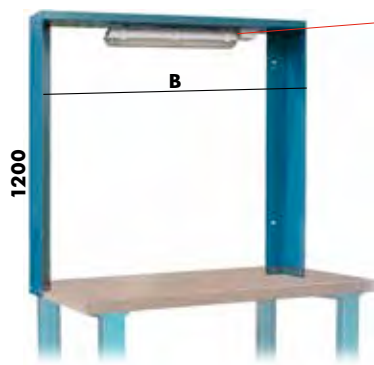

OOK IN ANDERE KLEUREN BESCHIKBAAR
 ORIG-NR MET EXTENSIE GR
 ORIG-NR MET EXTENSIE RL

toepassingen



steun:
werkbank: HE11215SL
HE13615DT



paneel:
steun:
werkbank: HE14520
HE11220SL
HE11220

Steun met fluorescerende lamp.

Order nr.	Orig. nr.	Breedte mm	Vermogen W	Gewicht kg	Prijs €
761003561	HE11210SLBL	1000	1x18	1,00	359,00
761003562	HE11213SLBL	1300	1x18	1,00	365,00
761003563	HE11215SLBL	1500	1x36	1,00	418,00
761003564	HE11218SLBL	1800	1x58	1,00	444,00
761003565	HE11220SLBL	2000	1x58	1,00	449,00



Steunen set voor panelen.

Order nr.	761002000
Orig. nr.	HE145CTPBL
Gewicht	kg 7,00
Prijs	€ 73,90

HECO

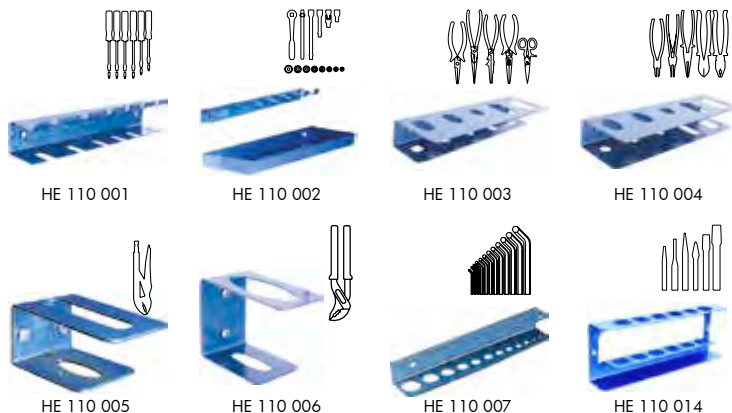

Gereedschapssteunen voor wandpanelen HE144, HE109 en HE110 (hout).

Order nr.	Orig. nr.	Aantal stuks	Gewicht kg	Prijs €
76100094	HE110001BL	1	0,14	5,30
76100095	HE110002BL	1	0,31	15,90
76100096	HE110003BL	1	0,12	5,60
76100097	HE110004BL	1	0,20	5,80
76100098	HE110005BL	1	0,07	4,10
76100099	HE110006BL	1	0,05	4,20
761000100	HE110007BL	1	0,11	5,40
761000107	HE110014BL	1	0,15	5,40

HECO

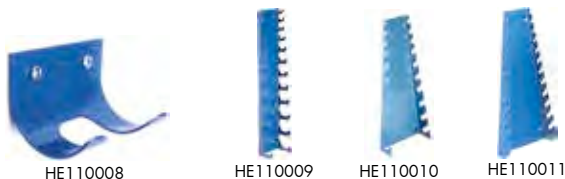

Gereedschapssteunen voor wandpanelen HE144, HE109 en HE110 (hout)

Order nr.	Orig. nr.	Aantal stuks	Gewicht kg	Prijs €
761000101	HE110008BL	2	0,12	6,10
761000102	HE110009BL	1	0,44	12,90
761000103	HE110010BL	1	0,30	14,90
761000104	HE110011BL	1	0,45	14,50

HECO



Gereedschapssteunen voor wandpanelen HE144, HE109 en HE110 (hout). HE110021 niet geschikt voor HE144.

Order nr.	Orig. nr.	Aantal stuks	Gewicht kg	Prijs €
761000105	HE110012BL	1	0,08	4,80
761000106	HE110013BL	1	0,11	4,10
761000108	HE110015BL	1	0,06	5,40
761000109	HE110016BL	1	0,04	5,00
761000110	HE110017BL	2	0,06	5,80
761000111	HE110018BL	1	0,03	7,60
761000114	HE110021BL	2	0,05	5,30



HE1391BL



HE1392BL

Materiaalkar. In plaatstaal 10/10mm, lateraal 30/10mm. Met kunststof wielen diameter 75mm.

Order nr.	761001059 €	761001060 €
Orig. nr.	HE1391BL	HE1392BL
Gewicht	kg 14,50	18,50
Afmetingen (l x b x h)	mm 700 x 450 x 800	810 x 480 x 900
Prijs	€ 177,00	191,00



HE1401BL



HE1402BL



HE1403BL

Materiaalkar. Gelast in plaatstaal 10/10mm, lateraal 30/10mm. Met kunststof wielen diameter 75mm.

Order nr.	761001061 €	761001062 €	761001063 €
Orig. nr.	HE1401BL	HE1402BL	HE1403BL
Gewicht	kg 13,80	16,55	16,50
Afmetingen (l x b x h)	mm 630 x 350 x 825	760 x 400 x 825	760 x 400 x 825
Prijs	€ 167,00	206,00	308,00

HECO

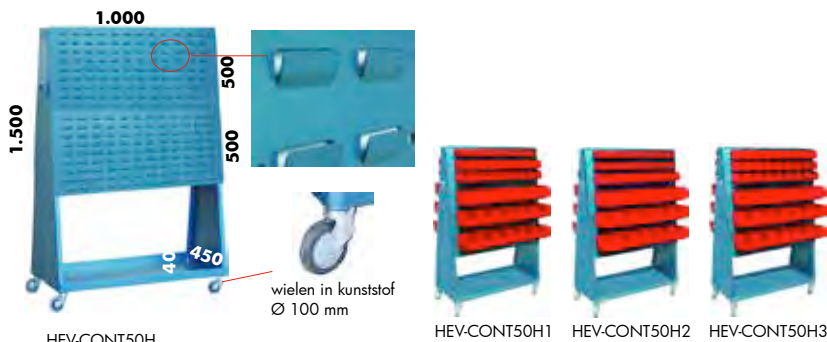

Paneel met rubberwielen voor bakjes V-BULL 1, 2 en 3.

Order nr.	Orig. nr.	Aantal bakjes	Gewicht kg	Afmetingen (l x b x h) mm	Prijs €
761001824	HEV-CONT50HBL	-	35,00	1000 x 1500 x 0	453,00
761001825	HEV-CONT50H1BL	16 x V-BULL1 - 32 x V-BULL2 - 36 x V-BULL3	65,70	1000 x 1500 x 0	669,00
761001826	HEV-CONT50H2BL	32 x V-BULL1 - 16 x V-BULL2 - 36 x V-BULL3	62,70	1000 x 1500 x 0	649,00
761001827	HEV-CONT50H3BL	48 x V-BULL2 - 36 x V-BULL3	71,10	1000 x 1500 x 0	679,00

HECO

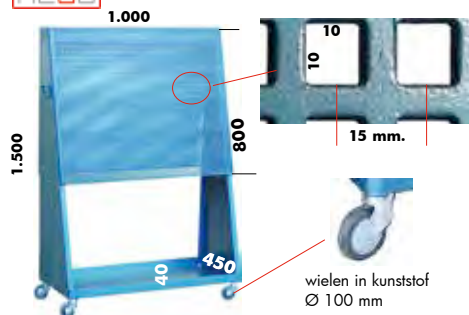

Geperforeerd paneel met rubberwielen.

Order nr.	Orig. nr.	Gewicht kg	Afmetingen (l x b x h) mm	Prijs €
761001108	HE14510RBL	33,00	1000 x 1500 x 0	479,00

HECO



Paneel met wielen voor bakjes V-BULL 1, 2 en 3.

Order nr.	Orig. nr.	Aantal bakjes	Gewicht kg	Afmetingen (l x b x h) mm	Prijs €
761003507	HEV-CONT45HBL	-	53,50	1000 x 1500 x 0	535,00
761003508	HEV-CONT45H1BL	384	71,50	1000 x 1500 x 0	845,00
761003509	HEV-CONT45H2BL	192	75,20	1000 x 1500 x 0	855,00
761003510	HEV-CONT45H3BL	108	78,00	1000 x 1500 x 0	929,00
761003511	HEV-CONT45H4BL	228	75,00	1000 x 1500 x 0	875,00

EQUIPMENT

Heco werkbanken



HE11220
Metaal

HE11220D
MDF:
hoge densiteit - PU gelakt

HE11220M
Kastanje hardhout -
PU gelakt

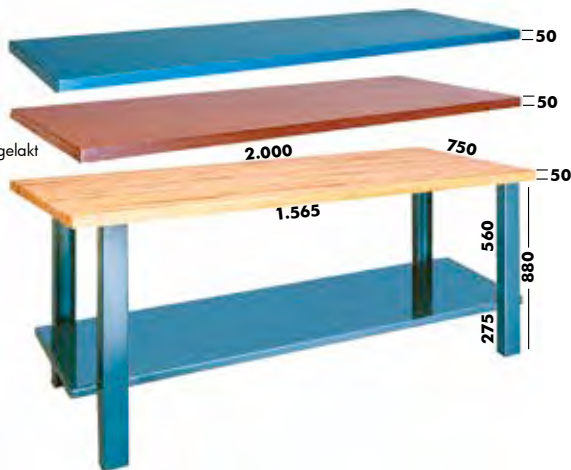

NEW



• Rubber vlak



• Rubber geopt



• 4 verstevigingen gelast aan de binnenkant van de legplank, geperforeerd om de 55mm, om 1 of 2 ladenblokken aan te bevestigen

• Regelbare voeten in ge vulcaniseerde kunststof

Robuuste stalen werkbanken met 5 types bovenbladen en stalen onderblad.

Kenmerken:

- Bovenblad leverbaar in:
 - staalplaat 20/10 met 4 verstevigingsbalken onderaan
 - PU-gelakte MDF 50mm van zeer hoge densiteit
 - PU-gelakt massief kastanjehout 50 mm
 - Stalen blad met vlakke rubber onder hoge druk verlijmd
 - Stalen blad met genopte rubber onder hoge druk verlijmd
- Niet gemonteerd geleverd
- leverbaar in breedte 1000, 1300, 1500, 1800 en 2000 mm
- Voeten voorzien van een rubber top ter bescherming van de werkvloer
- Aparte ladeblokken beschikbaar
- Draagvermogen onder verdeelde last : 700kg

OOK IN ANDERE KLEUREN BESCHIKBAAR
ORIG-NR MET EXTENSIE GR
ORIG-NR MET EXTENSIE RL

Order nr.	Orig. nr.	Bovenblad	Gewicht kg	Afmetingen (l x b x h) mm	Prijs €
761000195	HE11210BL	metaal	48,00	1000 x 750 x 880	369,00
761000207	HE11213BL	metaal	58,00	1300 x 750 x 880	418,00
761000219	HE11215BL	metaal	66,00	1500 x 750 x 880	468,00
761000233	HE11218BL	metaal	76,00	1800 x 750 x 880	515,00
761000245	HE11220BL	metaal	83,00	2000 x 750 x 880	565,00
761000197	HE11210DBL	MDF	56,00	1000 x 750 x 880	416,00
761000209	HE11213DBL	MDF	64,00	1300 x 750 x 880	477,00
761000222	HE11215DBL	MDF	71,00	1500 x 750 x 880	535,00
761000235	HE11218DBL	MDF	82,00	1800 x 750 x 880	595,00
761000247	HE11220DBL	MDF	92,00	2000 x 750 x 880	645,00
761000201	HE11210MBL	hout	51,00	1000 x 750 x 880	605,00
761000213	HE11213MBL	hout	60,00	1300 x 750 x 880	719,00
761000227	HE11215MBL	hout	68,00	1500 x 750 x 880	799,00
761000239	HE11218MBL	hout	77,00	1800 x 750 x 880	885,00
761000251	HE11220MBL	hout	83,00	2000 x 750 x 880	965,00
761040020	HE11210BL-GOM	rubber	48,00	1000 x 750 x 880	425,00
761040026	HE11213BL-GOM	vlakke rubber	58,00	1300 x 750 x 880	505,00
761040032	HE11215BL-GOM	vlakke rubber	66,00	1500 x 750 x 880	565,00
761040038	HE11218BL-GOM	vlakke rubber	76,00	1800 x 750 x 880	635,00
761040044	HE11220BL-GOM	vlakke rubber	83,00	2000 x 750 x 880	699,00
761040021	HE11210BL-GOMREL	genopte rubber	48,00	1000 x 750 x 880	529,00
761040027	HE11213BL-GOMREL	genopte rubber	58,00	1300 x 750 x 880	635,00
761040033	HE11215BL-GOMREL	genopte rubber	66,00	1500 x 750 x 880	719,00
761040039	HE11218BL-GOMREL	genopte rubber	76,00	1800 x 750 x 880	819,00
761040045	HE11220BL-GOMREL	genopte rubber	83,00	2000 x 750 x 880	905,00



HE11220R
Metaal

HE11220DR
MDF:
hoge densiteit - PU gelakt

HE11220MR
Kastanje hardhout -
PU gelakt



Robuuste stalen werkbanken met 5 types bovenbladen en stalen onderblad.

Kenmerken:

- **4 draaibare met PU-beklede nylonwielen ø150 mm, waarvan 2 geremd.**

- Bovenblad leverbaar in:
 - staalplaat 20/10 met 4 verstevigingsbalken onderaan
 - PU-gelakte MDF 50mm van zeer hoge densiteit
 - PU-gelakt massief kastanjehout 50 mm
 - Stalen blad met vlakke rubber onder hoge druk verlijmd
 - Stalen blad met genopte rubber onder hoge druk verlijmd
- Niet gemonteerd geleverd
- leverbaar in breedte 1000, 1300, 1500, 1800 en 2000 mm
- Voeten voorzien van een rubber top ter bescherming van de werkvloer
- Aparte ladeblokken beschikbaar
- Draagvermogen onder verdeelde last : 700kg



NEW



• Rubber vlak



• Rubber genopt



- 4 verstevigingen gelast aan de binnenkant van de legplank, geperforeerd om de 55mm, om 1 of 2 ladenblokken aan te bevestigen

EQUIPMENT

OOK IN ANDERE KLEUREN BESCHIKBAAR
ORIG NR MET EXTENSIE GR
ORIG NR MET EXTENSIE RL

Order nr.	Orig. nr.	Bovenblad	Gewicht kg	Afmetingen (l x b x h) mm	Prijs €
761000206	HE11210RBL	metaal	60,00	1000 x 750 x 880	799,00
761000218	HE11213RBL	metaal	70,00	1300 x 750 x 880	839,00
761000232	HE11215RBL	metaal	78,00	1500 x 750 x 880	885,00
761000244	HE11218RBL	metaal	88,00	1800 x 750 x 880	919,00
761000256	HE11220RBL	metaal	95,00	2000 x 750 x 880	959,00
761000200	HE11210DRBL	MDF	67,00	1000 x 750 x 880	835,00
761000212	HE11213DRBL	MDF	76,00	1300 x 750 x 880	885,00
761000226	HE11215DRBL	MDF	83,00	1500 x 750 x 880	945,00
761000238	HE11218DRBL	MDF	94,00	1800 x 750 x 880	985,00
761000250	HE11220DRBL	MDF	104,00	2000 x 750 x 880	1.025,00
761000204	HE11210MRBL	hout	63,00	1000 x 750 x 880	1.015,00
761000216	HE11213MRBL	hout	72,00	1300 x 750 x 880	1.115,00
761000230	HE11215MRBL	hout	80,00	1500 x 750 x 880	1.199,00
761000242	HE11218MRBL	hout	89,00	1800 x 750 x 880	1.285,00
761000254	HE11220MRBL	hout	95,00	2000 x 750 x 880	1.359,00
761040024	HE11210RBL-GOM	vlakke rubber	60,00	1000 x 750 x 880	775,00
761040030	HE11213RBL-GOM	vlakke rubber	70,00	1300 x 750 x 880	845,00
761040036	HE11215RBL-GOM	vlakke rubber	78,00	1500 x 750 x 880	919,00
761040042	HE11218RBL-GOM	vlakke rubber	88,00	1800 x 750 x 880	975,00
761040048	HE11220RBL-GOM	vlakke rubber	95,00	2000 x 750 x 880	1.035,00
761040025	HE11210RBL-GOMREL	genopte rubber	60,00	1000 x 750 x 880	875,00
761040031	HE11213RBL-GOMREL	genopte rubber	70,00	1300 x 750 x 880	975,00
761040037	HE11215RBL-GOMREL	genopte rubber	78,00	1500 x 750 x 880	1.075,00
761040043	HE11218RBL-GOMREL	genopte rubber	88,00	1800 x 750 x 880	1.159,00
761040049	HE11220RBL-GOMREL	genopte rubber	95,00	2000 x 750 x 880	1.239,00



HE11220PG
Metaal



HE11220DPG
MDF:
hoge densiteit - PU gelakt



HE11220MPG
Kastanje hardhout -
PU gelakt



OOK IN ANDERE KLEUREN BESCHIKBAAR
ORIG. NR. MET EXTENSIE GR.
ORIG. NR. MET EXTENSIE RL.

ACCESSOIRES
p. 586



NEW



• Rubber vlak



• Rubber genopt



• 4 verstevigingen gelast aan de binnenkant van de legplank, geperforeerd om de 55mm, om 1 of 2 ladenblokken aan te bevestigen

• Regelbare voeten in ge vulcaniseerde kunststof



HE112PG

Robuuste stalen werkbanken met 5 types bovenbladen en stalen onderblad.

Kenmerken:

- In de hoogte (per 25 mm) verstelbare voeten min/max 810/1060 mm
- Bovenblad leverbaar in:
 - staalplaat 20/10 met 4 verstevigingsbalken onderaan
 - PU-gelakte MDF 50mm van zeer hoge densiteit
 - PU-gelakt massief kastanjehout 50 mm
 - Stalen blad met vlakke rubber onder hoge druk verlijmd
 - Stalen blad met genopte rubber onder hoge druk verlijmd
- Niet gemonteerd geleverd
- leverbaar in breedte 1000, 1300, 1500, 1800 en 2000 mm
- Voeten voorzien van een rubber top ter bescherming van de werkvloer
- Aparte ladeblokken beschikbaar
- Draagvermogen onder verdeelde last : 700kg

EQUIPMENT

Order nr.	Orig. nr.	Bovenblad	Gewicht kg	Afmetingen (l x b x h) mm	Prijs €
761000205	HE11210PGBL	metaal	48,00	1000 x 750 x 880	499,00
761000217	HE11213PGBL	metaal	58,00	1300 x 750 x 880	555,00
761000231	HE11215PGBL	metaal	66,00	1500 x 750 x 880	609,00
761000243	HE11218PGBL	metaal	76,00	1800 x 750 x 880	635,00
761000255	HE11220PGBL	metaal	83,00	2000 x 750 x 880	699,00
761000199	HE11210DPGBL	MDF	56,00	1000 x 750 x 880	565,00
761000211	HE11213DPGBL	MDF	64,00	1300 x 750 x 880	609,00
761000225	HE11215DPGBL	MDF	71,00	1500 x 750 x 880	679,00
761000237	HE11218DPGBL	MDF	82,00	1800 x 750 x 880	719,00
761000249	HE11220DPGBL	MDF	92,00	2000 x 750 x 880	769,00
761000203	HE11210MPGBL	hout	56,00	1000 x 750 x 880	749,00
761000215	HE11213MPGBL	hout	60,00	1300 x 750 x 880	829,00
761000229	HE11215MPGBL	hout	68,00	1500 x 750 x 880	925,00
761000241	HE11218MPGBL	hout	77,00	1800 x 750 x 880	1.005,00
761000253	HE11220MPGBL	hout	83,00	2000 x 750 x 880	1.079,00
761040022	HE11210PGBL-GOM	vlakke rubber	48,00	1000 x 750 x 880	539,00
761040028	HE11213PGBL-GOM	vlakke rubber	48,00	1300 x 750 x 880	605,00
761040034	HE11215PGBL-GOM	vlakke rubber	48,00	1500 x 750 x 880	685,00
761040040	HE11218PGBL-GOM	vlakke rubber	48,00	1800 x 750 x 880	739,00
761040046	HE11220PGBL-GOM	vlakke rubber	83,00	2000 x 750 x 880	799,00
761040023	HE11210PGBL-GOMREL	genopte rubber	48,00	1000 x 750 x 880	639,00
761040029	HE11213PGBL-GOMREL	genopte rubber	58,00	1300 x 750 x 880	739,00
761040035	HE11215PGBL-GOMREL	genopte rubber	66,00	1500 x 750 x 880	835,00
761040041	HE11218PGBL-GOMREL	genopte rubber	76,00	1800 x 750 x 880	925,00
761040047	HE11220PGBL-GOMREL	genopte rubber	83,00	2000 x 750 x 880	1.005,00



HE15210



HE15215

OOK IN ANDERE KLEUREN BESCHIKBAAR
 ORIG. NR. MET EXTENSIE GR
 ORIG. NR. MET EXTENSIE RL



HE15220



EQUIPMENT

Werkbanken in stevige stalen constructie in blauwe hamerslagcoating. Bovenblad in metaal. Staaldikte 20/10.

- gelast
- hoge weerstand
- dikte bovenbladen 50mm
- leverbaar in diverse breedtes van 1000, 1500 en 2000mm
- voeten voorzien van een rubber top ter bescherming van de werkvloer

Order nr.	Orig. nr.	Gewicht kg	Afmetingen (l x b x h) mm	Prijs €
761001252	HE15210BL	78,00	1030 x 780 x 895	625,00
761001253	HE15215BL	105,00	1530 x 780 x 895	769,00
761001254	HE15220BL	132,00	2030 x 780 x 895	899,00

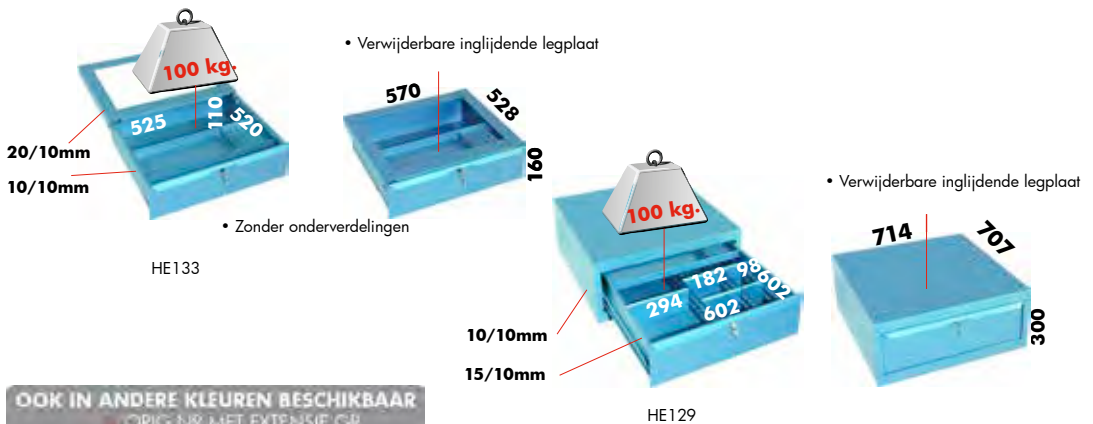
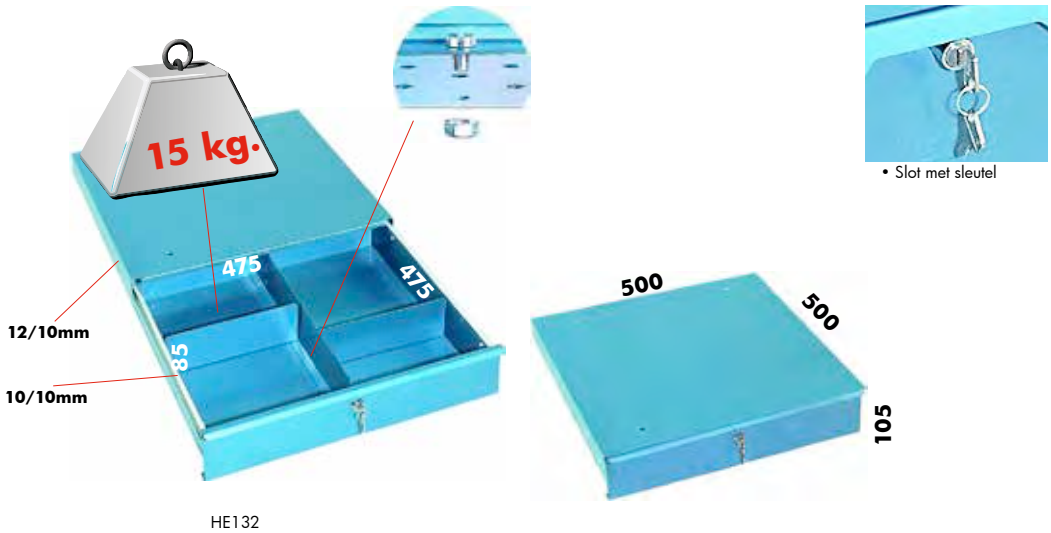

OOK IN ANDERE KLEUREN BESCHIKBAAR
 ORIG. NR. MET EXTENSIE GR.
 ORIG. NR. MET EXTENSIE RL.

Ladeblok voor werkbanken serie HE112.

- staaldikte variërend tussen 10/10, 12/10 en 15/10
- individueel afsluitbaar met sleutel
- compartimentering inbegrepen cfr. afbeeldingen
- wordt bevestigd aan de versterkingbalken in geval van een metalen topblad, in geval van houten of MDF bovenblad worden de ladeblokken met schroefbouten bevestigd (type bovenblad te vermelden bij bestelling).

Order nr.	Orig. nr.	Aantal laden	Afmetingen lade (1) mm	Afmetingen lade (2) mm	Afmetingen lade (3) mm	Afmetingen lade (4) mm	Gewicht kg	Afmetingen (l x b x h) mm	Prijs €
761000287	HE1131100BL	1	602x602x100	-	-	-	28,00	714 x 707 x 200	337,00
761000288	HE1131200BL	1	602x602x200	-	-	-	29,00	714 x 707 x 300	350,00
761000289	HE1132BL	2	602x602x75	602x602x125	-	-	37,00	714 x 707 x 300	505,00
761000290	HE1133BL	3	602x602x75	602x602x100	602x602x125	-	60,00	714 x 707 x 400	689,00
761000291	HE1134BL	4	602x602x75	602x602x75	602x602x125	602x602x125	76,00	714 x 707 x 500	839,00
761000914	HE129BL	1	602x602x200	-	-	-	34,90	714 x 707 x 300	348,00
761000918	HE132BL	1	475x475x85	-	-	-	9,00	500 x 500 x 105	95,90
761000919	HE133BL	1	525x520x110	-	-	-	12,90	570 x 528 x 160	139,00
761001255	HE1531100BL	1	406x490x100	-	-	-	18,00	515 x 600 x 200	262,00
761001256	HE1531200BL	1	378x490x200	-	-	-	21,00	515 x 600 x 300	295,00
761001257	HE1532BL	2	378x490x75	378x490x125	-	-	24,00	515 x 600 x 300	398,00
761001258	HE1533BL	3	378x490x75	378x490x100	378x490x125	-	37,50	515 x 600 x 400	515,00
761001259	HE1534BL	4	-	-	-	-	48,00	515 x 600 x 500	649,00

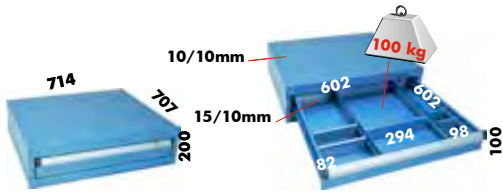

HE1131100

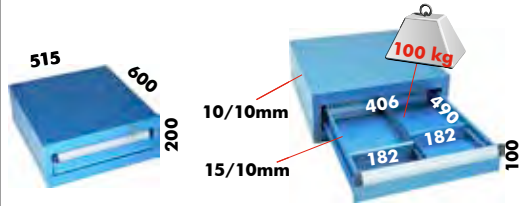

HE1531100

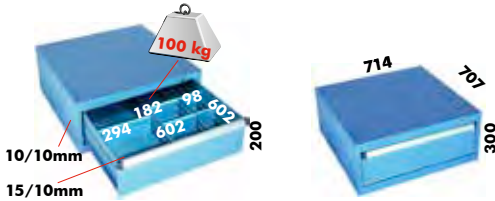

HE1131200

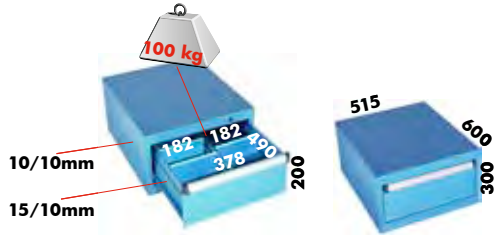

HE1531200

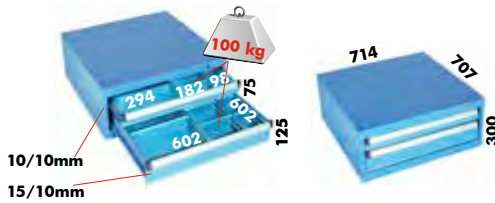

HE1132

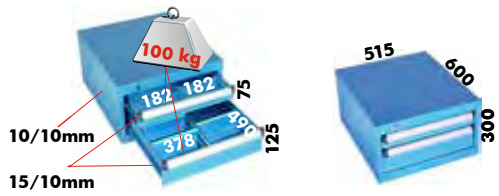

HE1532

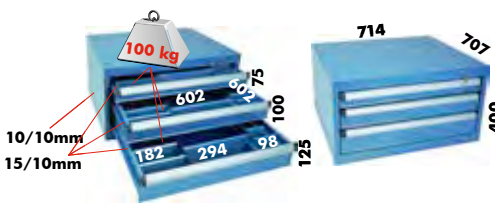

HE1133

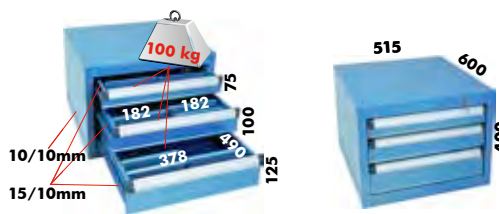

HE1533

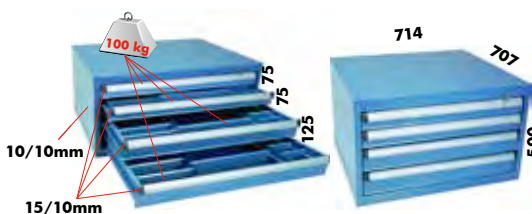

HE1134

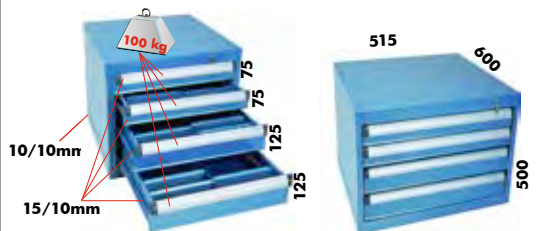

HE1534

EQUIPMENT



HE10913 + HE1133 + HE15013AM



- 4 verstevigingen gelast aan de binnenkant van de legplank, geperforeerd om de 55mm, om 1 of 2 ladenblokken aan te bevestigen



- Regelbare poten in gevulcaniseerde kunststof



- Ook leverbaar met opstaande rand (HE150P)
Zie www.vynckier.biz

Werkbanken in stevige stalen constructie in blauwe hamerslagcoating. Bovenblad leverbaar ofwel in een metaal, MDF of massief kastanjehout. Staaldikte 20/10. Niet gemonteerd geleverd.

- dikte bovenbladen 50mm
- leverbaar in diverse breedtes van 1000, 1300, 1500, 1800 en 2000mm
- voeten voorzien van een rubber top ter bescherming van de werkvloer
- werkbanken kunnen worden voorzien van 1 of 2 ladenblokken (ladenblokken van 1 tot 4 laden)

Order nr.	Orig. nr.	Bovenblad	Gewicht kg	Afmetingen (l x b x h) mm	Prijs €
761001148	HE15010ABL	metaal	81,00	1000 x 750 x 880	565,00
761001166	HE15013ABL	metaal	94,00	1300 x 750 x 880	635,00
761001183	HE15015ABL	metaal	105,00	1500 x 750 x 880	699,00
761001201	HE15018ABL	metaal	120,00	1800 x 750 x 880	769,00
761001218	HE15020ABL	metaal	126,00	2000 x 750 x 880	669,00
761001149	HE15010ADBL	MDF	82,00	1000 x 750 x 880	565,00
761001167	HE15013ADBL	MDF	94,00	1300 x 750 x 880	635,00
761001184	HE15015ADBL	MDF	103,00	1500 x 750 x 880	699,00
761001202	HE15018ADBL	MDF	117,00	1800 x 750 x 880	769,00
761001219	HE15020ADBL	MDF	129,00	2000 x 750 x 880	669,00
761001150	HE15010AMBL	hout	77,00	1000 x 750 x 880	755,00
761001168	HE15013AMBL	hout	90,00	1300 x 750 x 880	865,00
761001185	HE15015AMBL	hout	100,00	1500 x 750 x 880	939,00
761001203	HE15018AMBL	hout	112,00	1800 x 750 x 880	1.059,00
761001220	HE15020AMBL	hout	120,00	2000 x 750 x 880	985,00

HE15010A
metaal

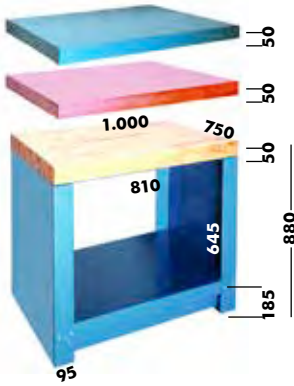

HE15010AD
MDF

HE15010AM
hout

OOK IN ANDERE KLEUREN BESCHIKBAAR
 ORIG. NR. MET EXTENSIE GR
 ORIG. NR. MET EXTENSIE RL

HE15018A
metaal

HE15018AD
MDF

HE15018AM
hout



HE15013A
metaal

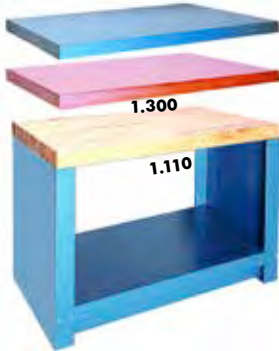

HE15013AD
MDF

HE15013AM
hout

HE15020A
metaal

HE15020AD
MDF

HE15020AM
hout



HE15015A
metaal

HE15015AD
MDF

HE15015AM
hout

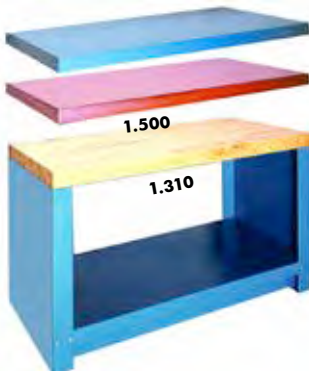

EQUIPMENT



HE150S

Werkbanken in stevige stalen constructie in blauwe hamerslagcoating. Bovenblad leverbaar ofwel in een metaal, MDF of massief kastanje hout. Staaldikte 20/10. Niet gemonteerd geleverd.

- dikte bovenbladen 50mm
- leverbaar in diverse breedtes van 1000, 1300, 1500, 1800 en 2000mm
- voeten voorzien van een rubber top ter bescherming van de werkvloer
- werkbanken kunnen worden voorzien van 1 of 2 ladeblokken (ladeblokken kunnen van 1 tot 4 laden)
- metalen bovenblad voorzien van versterkingen aan de onderkant. Max. draagvermogen gelijk verdeeld : 700kg.

Order nr.	Orig. nr.	Bovenblad	Gewicht kg	Afmetingen (l x b x h) mm	Prijs €
761001154	HE15010SBL	metaal	90,00	1000 x 750 x 880	735,00
761001172	HE15013SBL	metaal	105,00	1300 x 750 x 880	795,00
761001189	HE15015SBL	metaal	116,00	1500 x 750 x 880	845,00
761001207	HE15018SBL	metaal	132,00	1800 x 750 x 880	929,00
761001224	HE15020SBL	metaal	142,00	1800 x 750 x 880	839,00
761001155	HE15010SDBL	MDF	97,00	1000 x 750 x 880	759,00
761001173	HE15013SDBL	MDF	111,00	1300 x 750 x 880	845,00
761001190	HE15015SDBL	MDF	121,00	1500 x 750 x 880	885,00
761001208	HE15018SDBL	MDF	137,00	1800 x 750 x 880	965,00
761001225	HE15020SDBL	MDF	151,00	2000 x 750 x 880	875,00
761001156	HE15010SMBL	hout	92,00	1000 x 750 x 880	919,00
761001174	HE15013SMBL	hout	107,00	1300 x 750 x 880	1.059,00
761001191	HE15015SMBL	hout	118,00	1500 x 750 x 880	1.145,00
761001209	HE15018SMBL	hout	132,00	1800 x 750 x 880	1.265,00
761001226	HE15020SMBL	hout	142,00	2000 x 750 x 880	1.199,00



ACCESSOIRES
p. 578



Set werkbank-kast in stevige stalen constructie in blauwe hamerslagcoating. Bovenblad leverbaar ofwel in een metaal, MDF of massief kastanjehout. Staaldikte 20/10. Kasten met zeefdruk of met geperforeerd paneel. Niet gemonteerd geleverd.

- dikte bovenbladen 50mm
- breedte 1000mm, 1300mm, 1500mm, 1800mm of 2000mm
- voeten voorzien van een rubber top ter bescherming van de werkvloer

Order nr.	Orig. nr.	Bovenblad	Kast type	Gewicht kg	Afmetingen (l x b x h) mm	Prijs €
761001142	HE150101BL	metaal	zeefdruk paneel	114,00	1000 x 750 x 880	1.159,00
761001143	HE150102BL	metaal	geperforeerd paneel	112,00	1000 x 750 x 880	1.105,00
761001144	HE150103BL	DM	zeefdruk paneel	120,00	1000 x 750 x 880	1.185,00
761001145	HE150104BL	DM	geperforeerd paneel	118,00	1000 x 750 x 880	1.135,00
761001146	HE150105BL	hout	zeefdruk paneel	117,00	1000 x 750 x 880	1.365,00
761001147	HE150106BL	hout	geperforeerd paneel	115,00	1000 x 750 x 880	1.309,00
761001160	HE150131BL	metaal	zeefdruk paneel	133,00	1300 x 750 x 880	1.295,00
761001161	HE150132BL	metaal	geperforeerd paneel	133,00	1300 x 750 x 880	1.225,00
761001162	HE150133BL	DM	zeefdruk paneel	142,00	1300 x 750 x 880	1.349,00
761001163	HE150134BL	DM	geperforeerd paneel	142,00	1300 x 750 x 880	1.269,00
761001164	HE150135BL	hout	zeefdruk paneel	137,00	1300 x 750 x 880	1.555,00
761001165	HE150136BL	hout	geperforeerd paneel	137,00	1300 x 750 x 880	1.489,00
761001177	HE150151BL	metaal	zeefdruk paneel	146,00	1500 x 750 x 880	1.389,00
761001178	HE150152BL	metaal	geperforeerd paneel	145,00	1500 x 750 x 880	1.295,00
761001179	HE150153BL	DM	zeefdruk paneel	155,00	1500 x 750 x 880	1.429,00
761001180	HE150154BL	DM	geperforeerd paneel	161,00	1500 x 750 x 880	1.335,00
761001181	HE150155BL	hout	zeefdruk paneel	150,00	1500 x 750 x 880	1.659,00
761001182	HE150156BL	hout	geperforeerd paneel	149,00	1500 x 750 x 880	1.565,00
761001195	HE150181BL	metaal	zeefdruk paneel	167,00	1800 x 750 x 880	1.489,00
761001196	HE150182BL	metaal	geperforeerd paneel	166,00	1800 x 750 x 880	1.429,00
761001197	HE150183BL	DM	zeefdruk paneel	179,00	1800 x 750 x 880	1.505,00
761001198	HE150184BL	DM	geperforeerd paneel	178,00	1800 x 750 x 880	1.469,00
761001199	HE150185BL	hout	zeefdruk paneel	152,00	1800 x 750 x 880	1.805,00
761001200	HE150186BL	hout	geperforeerd paneel	151,00	1800 x 750 x 880	1.749,00
761001212	HE150201BL	metaal	zeefdruk paneel	171,00	2000 x 750 x 880	1.465,00
761001213	HE150202BL	metaal	geperforeerd paneel	171,00	2000 x 750 x 880	1.359,00
761001214	HE150203BL	DM	zeefdruk paneel	183,00	2000 x 750 x 880	1.509,00
761001215	HE150204BL	DM	geperforeerd paneel	183,00	2000 x 750 x 880	1.399,00
761001216	HE150205BL	hout	zeefdruk paneel	156,00	2000 x 750 x 880	1.815,00
761001217	HE150206BL	hout	geperforeerd paneel	156,00	2000 x 750 x 880	1.709,00



Werkbanken in stevige stalen constructie in blauwe hamerslagcoating.

- Bovenblad leverbaar in metaal of MDF
- Staaldikte 15-20/10
- Gemonteerd geleverd
- Dikte bovenbladen 40mm
- Leverbaar in diverse breedtes van 1000, 1500 tot 2000mm
- Voeten voorzien van een rubber top ter bescherming van de werkvloer

Order nr.	Orig. nr.	Bovenblad	Gewicht kg	Afmetingen (l x b x h) mm	Prijs €
761000126	HE1111001BL	MDF	104,00	1000 x 750 x 880	865,00
761000127	HE1111001CBL	metaal	104,00	1000 x 750 x 880	779,00
761000128	HE1111002BL	MDF	145,00	1000 x 750 x 880	1.775,00
761000129	HE1111002CBL	metaal	145,00	1000 x 750 x 880	1.675,00
761000130	HE1111003BL	MDF	127,00	1000 x 750 x 880	1.379,00
761000131	HE1111003CBL	metaal	127,00	1000 x 750 x 880	1.289,00
761000132	HE1111004BL	MDF	104,00	1000 x 750 x 880	969,00
761000133	HE1111004CBL	metaal	99,00	1000 x 750 x 880	875,00
761000134	HE1111005BL	MDF	112,00	1000 x 750 x 880	1.095,00
761000135	HE1111005CBL	metaal	107,00	1000 x 750 x 880	1.005,00
761000136	HE1111006BL	MDF	118,00	1000 x 750 x 880	1.235,00
761000137	HE1111006CBL	metaal	113,00	1000 x 750 x 880	1.135,00
761000138	HE1111007BL	MDF	111,00	1000 x 750 x 880	1.075,00
761000139	HE1111007CBL	metaal	106,00	1000 x 750 x 880	985,00
761000142	HE1111501BL	MDF	117,00	1500 x 750 x 880	1.235,00
761000143	HE1111501CBL	metaal	110,00	1500 x 750 x 880	1.115,00
761000144	HE1111502BL	MDF	125,00	1500 x 750 x 880	1.469,00
761000145	HE1111502CBL	metaal	118,00	1500 x 750 x 880	1.349,00
761000146	HE1111503BL	MDF	166,00	1500 x 750 x 880	2.275,00
761000147	HE1111503CBL	metaal	159,00	1500 x 750 x 880	2.155,00
761000148	HE1111504BL	MDF	199,00	1500 x 750 x 880	2.965,00
761000149	HE1111504CBL	metaal	192,00	1500 x 750 x 880	2.849,00
761000150	HE1111505BL	MDF	181,00	1500 x 750 x 880	2.559,00
761000151	HE1111505CBL	metaal	174,00	1500 x 750 x 880	2.445,00
761000152	HE1111506BL	MDF	130,00	1500 x 750 x 880	1.585,00
761000153	HE1111506CBL	metaal	123,00	1500 x 750 x 880	1.485,00
761000154	HE1111507BL	MDF	132,00	1500 x 750 x 880	1.565,00
761000155	HE1111507CBL	metaal	125,00	1500 x 750 x 880	1.465,00
761000156	HE1111508BL	MDF	153,00	1500 x 750 x 880	1.985,00
761000157	HE1111508CBL	metaal	146,00	1500 x 750 x 880	1.859,00
761000160	HE1112001BL	MDF	177,00	2000 x 750 x 880	2.219,00
761000161	HE1112001CBL	metaal	168,00	2000 x 750 x 880	2.069,00
761000162	HE1112002BL	MDF	163,00	2000 x 750 x 880	1.935,00
761000163	HE1112002CBL	metaal	154,00	2000 x 750 x 880	1.785,00
761000164	HE1112003BL	MDF	153,50	2000 x 750 x 880	1.805,00
761000165	HE1112003CBL	metaal	144,50	2000 x 750 x 880	1.645,00
761000166	HE1112004BL	MDF	186,50	2000 x 750 x 880	2.499,00
761000167	HE1112004CBL	metaal	177,50	2000 x 750 x 880	2.335,00
761000168	HE1112005BL	MDF	227,50	2000 x 750 x 880	3.319,00
761000169	HE1112005CBL	metaal	218,50	2000 x 750 x 880	3.159,00
761000170	HE1112006BL	MDF	250,50	2000 x 750 x 880	2.735,00
761000171	HE1112006CBL	metaal	241,50	2000 x 750 x 880	3.689,00
761000172	HE1112007BL	MDF	216,50	2000 x 750 x 880	3.135,00
761000173	HE1112007CBL	metaal	207,50	2000 x 750 x 880	2.975,00
761000174	HE1112008BL	MDF	182,00	2000 x 750 x 880	2.419,00
761000175	HE1112008CBL	metaal	173,00	2000 x 750 x 880	2.265,00



HE1111001

HE1111001C



HE1111002

HE1111002C



HE1111003

HE1111003C



HE1111004

HE1111004C



HE1111005

HE1111005C



HE1111006

HE1111006C



HE1111007

HE1111007C

OOK IN ANDERE KLEUREN BESCHIKBAAR
 ORIG NR MET EXTENSIE GR
 ORIG NR MET EXTENSIE RL

EQUIPMENT



HE1111501

HE1111501C



H200mm

HE1111502

HE1111502C



H200mm

H100mm
H100mm
H100mm
H100mm
H100mm

HE1111503

HE1111503C



H100mm
H100mm
H100mm
H100mm
H100mm
H100mm
H100mm
H100mm

H100mm
H100mm
H100mm
H100mm
H100mm
H100mm

HE1111504

HE1111504C



H200mm
H200mm
H200mm

H100mm
H100mm
H100mm
H100mm
H100mm

HE1111505

HE1111505C



H200mm

H200mm

HE1111506

HE1111506C



H100mm

H200mm

HE1111507

HE1111507C



H100mm

H100mm
H100mm

HE1111508

HE1111508C

EQUIPMENT

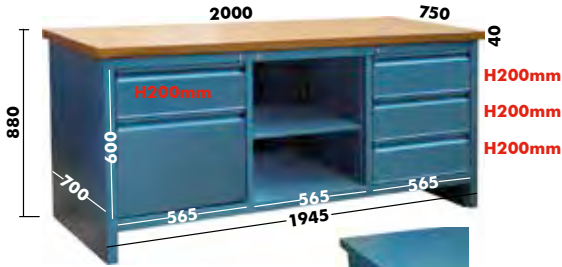

HE1112001

HE1112001C



HE1112002

HE1112002C



HE1112003

HE1112003C



HE1112004

HE1112004C



HE1112005

HE1112005C



HE1112006

HE1112006C



HE1112007

HE1112007C



HE1112008

HE1112008C

EQUIPMENT

HECO



• Centraal slot

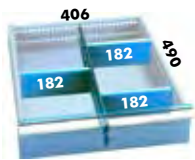

• Laden geleverd met 1 scheidingswand en 3 tussenschotten (behalve 300mm)



• Lade 300mm met houder voor 60 mappen



• Kasten standaard met 1 in de hoogte verstelbaar legbord

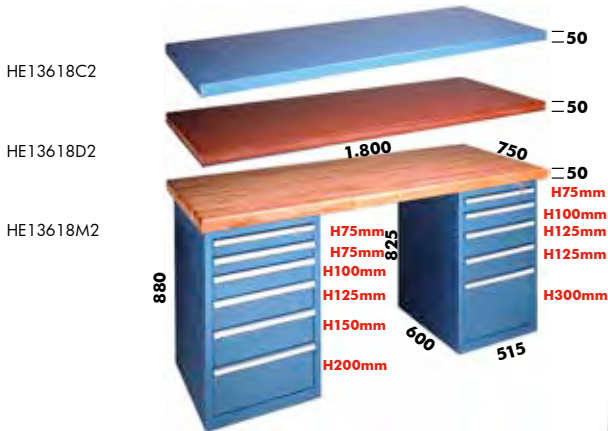

HE13618C2

HE13618D2

HE13618M2

HE13620C2

HE13620D2

HE13620M2

2 LADENKASTEN



OOK IN ANDERE KLEUREN BESCHIKBAAR
 ORIG. NR. MET EXTENSIE GR
 ORIG. NR. MET EXTENSIE RL

Werkbanken in stevige stalen constructie in blauwe hamerslagcoating. Bovenblad leverbaar in metaal, MDF of massief kastanjehout. Staaldikte 20/10. Gemonteerd geleverd.

- breedte 1800 of 2000mm
- werkhogte 880mm
- diepte en dikte van het bovenblad 750/50mm
- combinatie van bovenblad met 2 ladenkasten (6 laden en 5 laden)
- laden 90% uittrekbaar met draagvermogen van 100kg
- lade hoogte 300mm voorzien van houders voor 60 mappen (niet incl.)
- alle laden worden geleverd met 1 scheidingswand en 3 insteekschotjes
- alle ladenkasten zijn met een sleutel afsluitbaar

Order nr.	Orig. nr.	Bovenblad	Gewicht kg	Afmetingen (l x b x h) mm	Prijs €
761001006	HE13618C2BL	metaal	163,00	1800 x 623 x 880	2.529,00
761001011	HE13618D2BL	MDF	172,00	1800 x 623 x 880	2.569,00
761001016	HE13618M2BL	hout	165,00	1800 x 623 x 880	2.865,00
761001020	HE13620C2BL	metaal	174,00	2000 x 623 x 880	2.559,00
761001025	HE13620D2BL	MDF	186,00	2000 x 623 x 880	2.605,00
761001029	HE13620M2BL	hout	172,00	2000 x 623 x 880	2.935,00

HECO

HE13615C1

HE13615D1

HE13615M1



1.500

HE13618C1

HE13618D1

HE13618M1



1.800

VOET + LADENKAST

HE13620C1

HE13620D1

HE13620M1



2.000

OOK IN ANDERE KLEUREN BESCHIKBAAR

ORIG. NR. MET EXTENSIE GR
ORIG. NR. MET EXTENSIE RL

EQUIPMENT

Werkbanken in stevige stalen constructie in blauwe hamerslagcoating. Bovenblad leverbaar in metaal, MDF of massief kastanjehout. Staaldikte 20/10. Gemonteerd geleverd.

- leverbaar in breedte 1500, 1800 en 2000mm
- werkhoogte 880mm
- diepte en dikte van het bovenblad 750/50mm
- combinatie van bovenblad met 1 ladenkast (5 laden) en 1 vaste voet
- laden 90% uittrekbaar met draagvermogen van 100kg
- lade hoogte 300mm voorzien van houders voor 60 mappen (niet incl.)
- alle laden worden geleverd met 1 scheidingswand en 3 insteekschotjes
- alle laden zijn met een sleutel afsluitbaar

Order nr.	Orig. nr.	Bovenblad	Gewicht kg	Afmetingen (l x b x h) mm	Prijs €
761000998	HE13615C1BL	metaal	102,00	1500 x 623 x 880	1.479,00
761001000	HE13615D1BL	MDF	110,00	1500 x 623 x 880	1.509,00
761001002	HE13615M1BL	hout	105,00	1500 x 623 x 880	1.739,00
761001004	HE13618C1BL	metaal	111,00	1800 x 623 x 880	1.509,00
761001009	HE13618D1BL	MDF	121,00	1800 x 623 x 880	1.525,00
761001014	HE13618M1BL	hout	111,00	1800 x 623 x 880	1.825,00
761001019	HE13620C1BL	metaal	117,00	2000 x 623 x 880	1.525,00
761001024	HE13620D1BL	MDF	129,00	2000 x 623 x 880	1.565,00
761001028	HE13620M1BL	hout	115,00	2000 x 623 x 880	1.885,00



HE13615C11

HE13615D11

HE13615M11



VOET+KAST

HE13618C11

HE13618D11

HE13618M11



OOK IN ANDERE KLEUREN BESCHIKBAAR
 ORIG. NR. MET EXTENSIE GR
 ORIG. NR. MET EXTENSIE RL

Werkbanken in stevige stalen constructie in blauwe hamerslagcoating. Bovenblad leverbaar in metaal, MDF of massief kastanje hout. Staaldikte 20/10. Gemonteerd geleverd.

- leverbaar in breedte 1800 en 2000mm
- werkhoogte 880mm
- diepte en dikte van het bovenblad 750/50mm
- combinatie van bovenblad met 1 kast met 2 deuren en 1 vaste voet
- laden 90% uittrekbaar met draagvermogen van 100kg
- kast geleverd met 1 in de hoogte per 25mm verstelbaar legbord
- alle ladenkasten zijn met een sleutel afsluitbaar

Order nr.	Orig. nr.	Bovenblad	Gewicht kg	Afmetingen (l x b x h) mm	Prijs €
761000999	HE13615C11BL	metaal	74,00	1500 x 623 x 880	949,00
761001001	HE13615D11BL	MDF	82,00	1500 x 623 x 880	985,00
761001003	HE13615M11BL	hout	77,00	1500 x 623 x 880	1.245,00
761001005	HE13618C11BL	metaal	83,00	1800 x 623 x 880	985,00
761001010	HE13618D11BL	MDF	93,00	1800 x 623 x 880	1.025,00
761001015	HE13618M11BL	hout	83,00	1800 x 623 x 880	1.319,00



HE13620C21

HE13620D21

HE13620M21



KAST + LADENKAST

HE13618C21

HE13618D21

HE13618M21



EQUIPMENT

OOK IN ANDERE KLEUREN BESCHIKBAAR

ORIG. NR. MET EXTENSIE GR
ORIG. NR. MET EXTENSIE RL

Werkbanken in stevige stalen constructie in blauwe hamerslagcoating. Bovenblad leverbaar in metaal, MDF of massief kastankehout. Staaldikte 20/10. Gemonteerd geleverd.

- leverbaar in breedte 1800 en 2000mm
- werkhoogte 880mm
- diepte en dikte van het bovenblad 750/50mm
- combinatie van bovenblad met 1 ladenkast (5 laden) en 1 kast met 2 deuren
- laden 90% uittrekbaar met draagvermogen van 100kg
- lade hoogte 300mm voorzien van houders voor 60 mappen (niet incl.)
- alle laden worden geleverd met 1 scheidingswand en 3 insteekschotjes
- kast geleverd met 1 in de hoogte per 25mm verstelbaar legbord
- alle ladenkasten zijn met een sleutel afsluitbaar

Order nr.	Orig. nr.	Bovenblad	Gewicht kg	Afmetingen (l x b x h) mm	Prijs €
761001007	HE13618C21BL	metaal	135,00	1800 x 623 x 880	1.799,00
761001012	HE13618D21BL	MDF	145,00	1800 x 623 x 880	1.835,00
761001017	HE13618M21BL	hout	135,00	1800 x 623 x 880	2.135,00
761001021	HE13620C21BL	metaal	141,00	2000 x 623 x 880	1.829,00
761001026	HE13620D21BL	MDF	153,00	2000 x 623 x 880	1.869,00
761001030	HE13620M21BL	hout	139,00	2000 x 623 x 880	2.195,00

HECO

HE13618C22

HE13618D22

HE13618M22



HE13620C22

HE13620D22

HE13620M22



2 KASTEN

OOK IN ANDERE KLEUREN BESCHIKBAAR
 * ORIG. NR. MET EXTENSIE GR
 * ORIG. NR. MET EXTENSIE RL

Werkbanken in stevige stalen constructie in blauwe hamerslagcoating. Bovenblad leverbaar in metaal, MDF of massief kastanjehout. Staal dikte 20/10. Gemonteerd geleverd.

- leverbaar in breedte 1800 en 2000mm
- werkhogte 880mm
- diepte en dikte van het bovenblad 750/50mm
- combinatie van bovenblad met 2 kasten met 2 deuren
- laden 90% uittrekbaar met draagvermogen van 100kg
- kasten geleverd met 1 in de hoogte per 25mm verstelbaar legbord
- alle ladenkasten zijn met een sleutel afsluitbaar

Order nr.	Orig. nr.	Bovenblad	Gewicht kg	Afmetingen (l x b x h) mm	Prijs €
761001008	HE13618C22BL	metaal	107,00	1800 x 623 x 880	1.005,00
761001013	HE13618D22BL	MDF	117,00	1800 x 623 x 880	1.049,00
761001018	HE13618M22BL	hout	107,00	1800 x 623 x 880	1.349,00
761001022	HE13620C22BL	metaal	113,00	2000 x 623 x 880	1.039,00
761001027	HE13620D22BL	MDF	125,00	2000 x 623 x 880	1.079,00
761001031	HE13620M22BL	hout	111,00	2000 x 623 x 880	1.409,00

Order nr.	761040003
Orig. nr.	HE126WO02BL
Afmetingen (l x b x h) mm	714 x 300 x 550
Prijs	€ 629,00

Order nr.	761040002
Orig. nr.	HE126WO01BL
Afmetingen (l x b x h) mm	714 x 300 x 550
Prijs	€ 629,00

Order nr.	761040004
Orig. nr.	HE14507BL
Afmetingen (l x b x h) mm	714 x 25 x 500
Prijs	€ 60,90

Order nr.	761040001
Orig. nr.	HE1592F6BL
Afmetingen (l x b x h) mm	1000 x 600 x 1980
Prijs	€ 1.289,00



Order nr.	761040008
Orig. nr.	HE112WO04BL
Afmetingen (l x b x h) mm	2140 x 600 x 27
Prijs	€ 462,00

Order nr.	761040006
Orig. nr.	HE1221A01BL
Afmetingen (l x b x h) mm	714 x 600 x 900
Prijs	€ 1.435,00

Order nr.	761040005
Orig. nr.	HE112RE01BL
Lengte mm	2140
Afmetingen (l x b x h) mm	2140 x 0 x 0
Prijs	€ 595,00

Order nr.	761040007
Orig. nr.	HE1351MBL
Afmetingen (l x b x h) mm	515 x 600 x 885
Prijs	€ 1.435,00

OOK IN ANDERE KLEUREN BESCHIKBAAR
 ORIG. NR. MET EXTENSIE GR
 ORIG. NR. MET EXTENSIE RL



EQUIPMENT

Luchtslangen



Soft PVC slang versterkt met polyestervezels. 10/20 m met Euro snelkoppelingen. Versie 50 m zonder koppeling. Extreem flexibel ook bij lage temperatuur.

Order nr.	Orig. nr.	Lengte	Diameter inwendig	Diameter uitwendig	Maximum druk	Gewicht	Prijs
		m	mm	mm	bar	kg	€
712105610	PSW106	10	6	10,7	20	0,90	15,50
712105420	2105420	20	6	10,7	20	0,90	34,90
712105910	2105510	10	9	14,5	20	1,47	22,50
712105520	PSW209	20	9	14,5	20	9,20	27,90
712105650	2105450	50	6	10,7	20	3,85	47,90
712105950	PSW509	50	9	14,5	20	6,70	48,50
712105703	2105750	50	13	19	13	9,00	84,50



Standaard Spiraal luchtslang in polyurethaan met snelkoppeling en steeknippel

Order nr.	712115608	
Orig. nr.	2115608	
Lengte	m	7,5
Maximum druk	bar	8
Diameter	mm	6-10
Gewicht	kg	0,34
Prijs	€	15,50



SS68PRO

SS65PRO

Kwaliteit spiraal luchtslang. Pro serie. PU met snelkoppeling en met draaistuk 360°. Hoge flexibiliteit en kniksterkte. SS68Pro met EURO koppeling.

Order nr.	712105854	712105850
Orig. nr.	SS68PRO	SS65PRO
Lengte slang	m	6
Diameter inwendig	mm	8
Diameter uitwendig	mm	12
Aansluiting	inch	1/4
Maximum druk	bar	8
Diameter	mm	8-12
Gewicht	kg	0,40
Prijs	€	38,50



• Optionele balanceer kontrol

Spiraal luchtslang voor balanceer kontrol

- Hoogwaardige PA12 spiraalslang voor gebruik met balanceer kontrol FZ
- 1 m aansluitingsdarm voor aansluiting met luchtdruknetwerk
- Inclusief alle montageonderdelen.
- PA12 spiraalslang 8mm ID x 10 mm AD
- Max werklengte met terugtrekveer 1,6 m

Tip: voor aansluiting op net, 1 x snelkoppeling 6 mm 712200021, nippel 6 mm 712200031, 2 x slangklemmen 712105008

Order nr.	712106050	
Orig. nr.	2106050	
Gewicht	kg	1,00
Prijs	€	68,90



• 2 x 16A

Verdeelbox voor druklucht en elektriciteit.

Kenmerken:

- Geschikt voor mobiel gebruik op de grond of in de lucht op de gewenste hoogte.
- Stof- en waterdicht IP44
- Handgreep/werktuighaak
- 3 m messingketting
- 3 m H07RNF rubber-neopreen kabel
- 3 m drukluchtslang 9 mm

Order nr.	712100001	712100002
Orig. nr.	A-EA1	A-EA2
Type oprollhaspel	drukluft en elektriciteit	drukluft en elektriciteit
Lengte kabel	m	3
Spanning	V	230
Kabel	mm ²	1,5
Lengte slang	m	3
Muurbevestiging	✓	✓
Lengte	m	3
Luchtdrukaansluiting	1 EURO	1 EURO
Gewicht	kg	2,00
Prijs	€	69,90

Blaaspistolen

aircraft



Handige, robuuste blaaspistool in aluminium met koppeling. Werkdruk 2 tot 8 Bar. Luchtverbruik 80-300l/min.

Order nr.	712102100 ^M	712102110 ^M
Orig. nr.	BPK	BPL
Lengte blaaspijp	mm 25	130
Gewicht	kg 0,18	0,22
Prijs	€ 4,90	6,40

TOOLS



Blaaspistool in kunststof met 2 lengte blaaspijp.

Order nr.	737551500 ^T	737553000 ^T
Orig. nr.	PNBL150	PNBL300
Lengte blaaspijp	mm 150	300
Gewicht	kg 0,16	0,20
Prijs	€ 7,50	9,60

aircraft

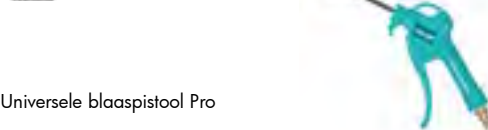

Universele blaaspistool Pro

- Volkunststofbehuizing - geen koude handen meer.
- Met grote hendel voor goede dosering en met koppeling
- Toepassingen in productie, werkplaats en automotive. Snel reinigen grote oppervlaktes.

Order nr.	712112120 ^M
Orig. nr.	BP PRO
Gewicht	kg 0,14
Prijs	€ 8,50

aircraft



Universele blaaspistool Pro in XL en XXL uitvoering

- Volkunststofbehuizing - geen koude handen meer.
- Met grote hendel voor goede dosering en met koppeling
- Toepassingen in productie, werkplaats en automotive. Snel reinigen grote oppervlaktes.

Order nr.	712112124 ^M	712112125 ^M
Orig. nr.	BP PRO XL	BP PRO XXL
Werkdruk	bar 2-8	2-8
Luchtverbruik	l/min 80-300	80-300
Lengte blaaspijp	mm 500	800
Gewicht	kg 0,18	0,22
Prijs	€ 14,90	19,50

aircraft



• Gummi kop

• Regelbaar

BP PRO R

BP PRO G

Blaaspistool BP PRO G met gummikop

Blaaspistool BP PRO R met gummikop en regelbare max. druk

- Volkunststofbehuizing - geen koude handen meer.
- Afneembare gummi (rubberen) lop
- Met grote hendel voor goede dosering en met koppeling
- Toepassingen in productie, werkplaats en automotive. Voor gevoelige oppervlaktes.

Order nr.	712112130 ^M	712102125 ^M
Orig. nr.	BP PRO R	BP PRO G
Luchtverbruik	l/min 80-300	80-300
Regelbaar	Ja	Nee
Gewicht	kg 0,14	0,14
Prijs	€ 18,50	10,90

aircraft



Universele blaaspistool Pro in L uitvoering

- Volkunststofbehuizing - geen koude handen meer.
- Met grote hendel voor goede dosering en met koppeling
- Toepassingen in productie, werkplaats en automotive. Snel reinigen grote oppervlaktes.

Order nr.	712112123 ^M
Lengte blaaspijp	mm 250
Prijs	€ 12,90

aircraft



Blaaspistool BPP PRO V met venturikop

- Volkunststofbehuizing - geen koude handen meer.
- Circa 100% hogere luchtdoorvoer door de venturi-kop.
- Met grote hendel voor goede dosering en met koppeling
- Toepassingen in productie, werkplaats en automotive.

Order nr.	712112122 ^M
Orig. nr.	BP PRO V
Gewicht	kg 0,17
Prijs	€ 17,00

EQUIPMENT



8-delig persluchtset.

8-DELIGE SET

Bestaat uit

- 1 kort blaaspistool,
- 1 bandenblazer SD,
- 3 blaasstukjes,
- 1 verfpistool,
- 1 vernevelpistool
- 1 spiraalslang.

Order nr.	712102008	
Orig. nr.	PG8	
Gewicht	kg	2,30
Prijs	€	50,50



Blaaspistool BPI PRO met venturinaald- en kop

- Volkunststofbehuizing - geen koude handen meer.
- Circa 100% hogere luchtdoorvoer door de venturinaald en kop.
- Met grote hendel voor goede dosering en met koppeling
- Toepassingen in productie, werkplaats en automotive.

Order nr.	712102170	
Orig. nr.	BPI PRO	
Werkdruk	bar	1-6
Luchtverbruik	l/min	100-200
Gewicht	kg	0,24
Prijs	€	17,50



Professioneel blaaspistool met twee aansluitingen

- In alu met rubberen bekleding.
- Met fijnregeling van het debiet.
- 2 aansluitingen voor luchtinlaat boven- en onderaan, voorkomt verwarde toevoerslangen.
- Met lange (112 mm) en korte blaastuit.

Order nr.	712102190	
Orig. nr.	BP PRO DUO	
Gewicht	kg	0,20
Prijs	€	24,90



6-DELIGE SET

6-delig persluchtset.

Bestaat uit:

- 1 kort blaaspistool,
- 1 bandenblazer SD,
- 1 spiraalslang,
- 3 blaasstukjes.

Order nr.	712102006	
Prijs	€	26,50



Schermplaat BP PRO beschermt ogen en gezicht tegen opspattende deeltjes.

Order nr.	712112150	
Orig. nr.	2112150	
Gewicht	kg	0,05
Prijs	€	7,60



Blaaspistool Soft BPS PRO. Blazen door indrukken. Traploos regelbaar.

Order nr.	712102130	
Orig. nr.	BPS PRO	
Gewicht	kg	0,06
Prijs	€	8,80

Bandenblazers



Bandenblazer / Bandenvulmeter

- Alu behuizing
- Met manometer ø 63 mm.
- Met snelkoppeling.
- Versie SD-G geijkte versie

Order nr.	712102300 ^M	712102350 ^M
Orig. nr.	SD	SD-G
Werkdruk maximum	bar 8	10
Aflezing	bar 0-8	0-10
Geijkt		✓
Prijs	€ 15,50	34,50



Set van 3 pompnippels.

- Ideaal voor het gebruik thuis.
- Een fietsadaptor
- Een smalle en dikke naald voor fietsen, ballen, opblaasbootjes en luchtmatrassen.

Order nr.	712102900 ^M
Orig. nr.	2102900
Prijs	€ 4,95



Dubbele vulstekker (trekken/duwen) voor alle types van ventielen.

Met slangaansluiting ø 6 mm

Order nr.	712102605 ^M
Orig. nr.	2102605
Prijs	€ 11,90



Tankstation pompnippel met handgreep en gedraaide kop

- Universele pompnippel dubbel gebruik (trekken/duwen)
- Met handgreep
- Gedraaide kop voor gemakkelijke bereikbaarheid
- Past op alle snelstekkers.

Order nr.	712102803 ^M
Orig. nr.	PRO-DUO
Omschrijving	vulstekker
Gewicht	kg 0,15
Prijs	€ 28,50



Professionele bandenvulmeter PRO en PRO-G met snelstekker.

- PRO-G is een geijkte versie
- Handig en sterk composiet handvat (geen koude handen meer)
- Hoogwaardige precisie manometer ø 80 mm met detail aanduiding
- EURO-steeknippel

Order nr.	712102500 ^M	712102600 ^M
Orig. nr.	PRO	PRO G
Werkdruk maximum	bar 12	12
Aflezing	bar 0-10	0-10
Geijkt		✓
Prijs	€ 62,90	78,50



Compacte geijkte professionele bandenblazer PRO-G KOMPAKT

- Compacte degelijke alu behuizing en hefboom-pompnippel.
- Geijkte versie
- Hoogwaardige metalen manometer met overdrukbescherming ø 63mm.
- EURO-steeknippel

Order nr.	712103010 ^M
Orig. nr.	PRO G KOMPAKT
Werkdruk maximum	bar 10
Aflezing	bar 0-10
Geijkt	✓
Prijs	€ 100,00



Luchtdruktester. Hoofdzakelijk voor autobanden. Met kaliber voor min. druk 0,5 bar/7,5 PSI tot max. 3 bar/43 PSI. Zeer accurate en makkelijk te lezen display. Lang recht model. Dubbel zijdigedruktuit. Geleverd met ophanging.

Order nr.	208260109 ^T
Orig. nr.	208260109
Prijs	€ 19,50



Professionele bandenblazer PRO-E met kip-snelstecker.

- PRO-E versie met hefboom pompnippel
- Handig en sterk composiet handvat (geen koude handen meer)
- Hoogwaardige precisie manometer ø 63mm
- EURO-steeknippel

Order nr.	712102700	
Orig. nr.	PRO E	
Werkdruk maximum	bar	10
Diameter slang	mm	8-12
Prijs	€	53,50



Professionele bandenvulmeter geijkt PRO-GH

Troeven:

- Robuuste uitvoering met hefboom pompnippel
- Hoogwaardige manometer tegen overdruk verzekerd ø 80 mm met 2 schalen. slagvaste behuizing
- Optionele vulslang 2,5m (ref. 712102804)
- Koppeling: EURO-steeknippel

Geschikt voor

- Tankstations, garages, werkplaatsen

Order nr.	712102800	
Orig. nr.	PRO-G H	
Werkdruk maximum	bar	10
Aflezing	bar	0-10
Geijkt	✓	
Prijs	€	155,00



Professionele bandenblazer geijkt met dubbel vulstecker PRO-G DUO



Troeven:

- Robuuste uitvoering met universele, dubbele vulstecker (trekken/duwen) met handgreep en gedraaide kop voor gemakkelijke bereikbaarheid
- Hoogwaardige manometer ø 80 mm met 2 schalen. slagvaste behuizing
- Optionele vulslang 2,5m (ref. 712102804)
- Koppeling: EURO-steeknippel

Geschikt voor:

- Tankstations, garages, werkplaatsen, ook geschikt voor moto's

Order nr.	712102850	
Orig. nr.	PRO-G DUO	
Werkdruk maximum	bar	10
Aflezing	bar	0-10
Geijkt	✓	
Prijs	€	171,00



Geijkte draagbare bandenvulmeter met drukat 6 liter.

Troeven:

- Druktank 6 liter op 16 bar
- Met dubbelzijdige blaasnippel met handvat met +/- drukknooppes
- Geschikt voor alle types nippes
- Grote manometer aflezing 0-10 Bar + 0-140 psi
- Koppeling: EURO-steeknippel

Geschikt voor:

- Mobiel gebruik onderweg of depannages

Order nr.	712102860	
Orig. nr.	SFM-G	
Werkdruk maximum	bar	10
Aflezing	bar	0-10
Omschrijving	tank 6 l	
Geijkt	✓	
Prijs	€	949,00



11 delige bandwisselset om eenvoudig uw autobanden te wisselen

Bestaat uit:

- Bandenblazer SD
- Blaaspistool BPK
- 1/2" slagmoersleutel met doppen (17, 19 en 21mm),
- Spiraalslang 5m,
- 3 pompnippes.
- In degelijke opbergkoffer in kunststof

Order nr.	712400100	
Orig. nr.	2400100	
Prijs	€	89,90

Siliconesputters



Pneumatische siliconespuit. Geschikt voor alle standaard cartouches. Met snelontluchting.

Order nr.	712102250 	
Orig. nr.	KP	
Werkdruk	bar	1,22
Consommation d'air	l/min	+/-50
Gewicht	kg	0,50
Prijs	€	53,50





Pneumatische siliconespuit. Geschikt voor alle standaard cartouches. Met snelontluchting. Geen nalooop na het stoppen. traploze regeling voor juiste dosering. draaibare bushouder, voor gemakkelijk werken in alle richtingen.

Order nr.	712102260 	
Werkdruk	bar	ca. 1,5-2,5
Luchtverbruik	l/min	+/-60
Prijs	€	125,00



Pneumatisch siliconespuit. Professioneel model. Geschikt voor alle standaard cartouches. Met snelontluchting en zonder nalooop na het stoppen. Dosering traploos instelbaar.

Order nr.	712102270 	
Orig. nr.	KP PRO	
Werkdruk	bar	8
Luchtverbruik	l/min	100
Gewicht	kg	1,04
Prijs	€	204,00





Pneumatisch siliconespuit voor 600 ml siliconebussen en worsten. Professioneel model. Met snelontluchting en zonder nalooop na het stoppen. Dosering traploos instelbaar.

Order nr.	712102290 	
Werkdruk maximum	bar	8
Luchtverbruik	l/min	100
Prijs	€	221,00

Plaatbewerking





Boormachine links-rechts draaiend BM PRO. Lichte en handige boormachine met links-rechts schakelaar voor hout en metaal. De luchtuitlaat gebeurt via het handvat om werveling van braamsel te vermijden. De boormachine is uitgerust met een zelfspannende boorkop 1-10 mm en handgreep.

Order nr.	712404100 	
Orig. nr.	BM R+L PRO	
Luchtverbruik	m/s ²	360
Toerental onbelast	rpm	+/- 1800
Werkdruk	bar	6
Capaciteit	mm	10
Gewicht	kg	1,10
Prijs	€	53,50





COMPOSIT

Boormachine. Links-rechts draaiend. Met composietbehuizing. Lichte en handige boormachine met links-rechts schakelaar voor hout en metaal. De luchtuitlaat gebeurt via het handvat om werveling van braamsel te vermijden.

Order nr.	712404150 	
Orig. nr.	BM 10 PRO	
Werkdruk	bar	6,3
Luchtverbruik	l/min	460
Toerental	tpm	1800
Capaciteit	mm	10
Gewicht	kg	0,90
Prijs	€	85,50



Haakse Boormachine, links-rechts draaiend met snelspanboorkop 3/8". Dubbele aandrijving garandeert een rustige loop en langere levensduur. Grote verticale handgreep. Lichte en handige composietuitvoering. De luchtuitlaat gebeurt via het handvat om werveling van braamsel te vermijden. Boorkop 1-10 mm

Order nr.	712404190 	
Orig. nr.	WB10 PRO	
Toerental onbelast	rpm	1900
Werkdruk	bar	6,3
Luchtverbruik	l/min	280
Gewicht	kg	1,10
Prijs	€	133,00

aircraft



Multitool voor het snijden en schuren in carrosserie, hout en andere toepassingen.

- Voor het uitsnijden van autoruiten en andere kleefverbindingen.
- Opschuren van diverse moeilijk bereikbare plaatsen
- Geleverd met 3 messen: 37mm recht, 47m recht en 48mm gebogen;
- optioneel diverse messen en schuurkoppen beschikbaar.
- Veiligheid tegen onbedoeld inschakelen.
- Geluidsarm werken.
- Ook bruikbaar met schuurshijven.
- Geleverd met set snijmesses en koffer.

Order nr.		712404850
Toerental	1/min	20.000
Werkdruk	bar	6.3
Luchtverbruik	l/min	280
Prijs	€	0,00

aircraft



Rechte snelslijper. 5 slijpstenen op as diam. 3 mm, 5 slijpstenen op as diam. 6 mm, 1 bits en 1 adapter voor 3 en 6 mm, gereedschap, geleverd in een plastic koffer. Voor het slijpen, borstelen en afbramen.

Order nr.		712403190
Orig. nr.		STS
Werkdruk	bar	6
Luchtverbruik	l/min	270
Toerental onbelast	rpm	+/- 24000
Prijs	€	39,50

aircraft



Rechte slijper. Met ergonomische handgrip in kunststof voor isolatie tegen vibraties en koude luchtstroom. Set bevat 2 spanklauwen (3mm en 6 mm), 5 slijpstenen, 1 adapter en spanwerktuigen. Voor slijpen, borstelen en afbramen. In hoogwaardige kunststofkoffer.

Order nr.		712403200
Orig. nr.		STSPRO
Werkdruk	bar	6,3
Luchtverbruik	l/min	330
Aansluiting	mm	6
Toerental	tpm	22000
Prijs	€	74,90

aircraft



Rechte slijper. Speciaal ontworpen voor roterende vijlen en slijpstenen. Voor schacht diameter 3 mm, 6 mm en 1/4". Voorzien van luchtafvoer langs achteren, veiligheidshendel om ongewild starten te voorkomen, ingebouwde snelheidsregulator en een koppeling die 360° draaibaar is. Ontworpen voor gemakkelijk gebruik met ergonomisch rubberen handvat. Bescherming tegen koude luchtstromen voor comfortabel gebruik. Handig voor gebruik op moeilijk te bereiken plaatsen. Standaard geleverd met een adaptor 3 mm, een adaptor 6 mm en een adaptor 1/4".

Order nr.		207370107
Orig. nr.		207370107
Toerental	tpm	25000
Voor schacht diameter	mm/inch	3-6-1/4
Geluidsniveau	dB(A)	83
Vibratie	m/s ²	3,6
Minimum maat slang	inch	3/8
Luchtaansluiting	G (R)	1/4
Lengte	mm	160
Prijs	€	113,00

aircraft



Rechte slijper. Speciaal ontworpen voor roterende vijlen en slijpstenen. Voor schacht diameter 3 mm, 6 mm en 1/4". Voorzien van luchtafvoer langs achteren, veiligheidshendel om ongewild starten te voorkomen, ingebouwde snelheidsregulator en een koppeling die 360° draaibaar is. Ontworpen voor gemakkelijk gebruik met ergonomisch rubberen handvat. Bescherming tegen koude luchtstromen voor comfortabel gebruik. Handig voor gebruik op moeilijk te bereiken plaatsen. Mini model in set (12977) standaard geleverd met een adaptor 3 mm, een adaptor 6 mm en een adaptor 1/4", 5 stuks slijpstenen 3 mm, 5 stuks slijpstenen 6mm, een mini oliebusje en twee opspanstukken.

Order nr.		207390105
Orig. nr.		207390105
Toerental	tpm	25000
Geluidsniveau	dB(A)	86
Vibratie	m/s ²	3,6
Minimum maat slang	inch	3/8
Luchtaansluiting	G (R)	1/4
Lengte	mm	160
Voor schacht diameter	mm	3-6-1/4
Prijs	€	145,00

aircraft



Knabberscharen voor het knippen, stansen en vormsnijden in plaatmateriaal. Isolerend composiethandvat, vibratiearm. model BN PRO geschikt voor zeer korte bochten of in oneffen materiaal zoals golfplaat.

Order nr.	712404550	712404450
Orig. nr.	BN PRO	BS PRO
Snijbreedte	mm 5	5
Snijcapaciteit - staalplaat	mm 1,2	1,2
Snijcapaciteit - aluminiumplaat	mm 1,6	1,6
Snijsnelheid	slagen/min 2600	2600
Verbruik	l/min 200	450
Gewicht	kg 1,10	1,30
Prijs	€ 91,50	110,00

aircraft



Carrosseriezaag US PRO. Verzaagt tot 3,2mm aluminium en 1,6mm staalplaat.

Order nr.	712404660
Orig. nr.	US PRO
Werkdruk maximum	bar 6,3
Luchtverbruik	l/min 230
Toerental	min-1 10000
Slag	mm 10
lengte staaf	mm 125
Gewicht	kg 0,50
Prijs	€ 229,00

aircraft



Stans- en fixeeraapparaat voor plaatmateriaal; geschikt voor carrossiewerk. voor het uitstansen van puntlassen of fixeren van 2 platen op elkaar.

Order nr.	712404800
Orig. nr.	LAG PRO
Snijbreedte	mm 5
Snijcapaciteit - staalplaat	mm 1,2
Snijcapaciteit - aluminiumplaat	mm 1,2
Gewicht	kg 1,50
Prijs	€ 110,00

aircraft



Opzet naaldontroester voor hakhamers type MHU, MHB en MHV PRO

Order nr.	712402600
Orig. nr.	2402600
Gewicht	kg 1,10
Prijs	€ 31,90

aircraft



Naaldontroesters voor het verwijderen van corrosie, lasslak, verf of betonresten op harde ondergronden op bereikbare plaatsen. Rechte of pistoolvorm. Gehard staal en volledig metalen behuizing voor lange levensduur. Vervangbare naaldkop.

Order nr.	712402620	712402640
Orig. nr.	NE PRO	NP PRO
Werkdruk maximum	bar 6,3	6,3
Luchtverbruik	l/min 170	170
Toerental	min-1 3800	3200
lengte staaf	mm 125	180
Gewicht	kg 1,00	2,60
Prijs	€ 125,00	221,00

aircraft



Rechte staafslijper voor slijpen, borstelen en afbramen. zeer compact en licht. variabel toerental. Met ergonomische handgrip in kunststof voor isolatie tegen vibraties en koude luchtstroom. Set bevat 2 spanklauwen 6 mm.

Order nr.	712403250
Orig. nr.	2403250
Werkdruk	bar 6,3
Luchtverbruik	l/min 330
Toerental onbelast	rpm 22000
Voor schacht diameter	mm 6
Prijs	€ 88,50

aircraft



Haakse slijper. Voor schijven tot diameter 125mm. Hoge capaciteit.

Order nr.	712403470
Orig. nr.	WS125 PRO
Werkdruk	bar 6,3
Luchtverbruik	l/min 490
Aansluiting	mm 22
Toerental voor schijf diam.	tpm 10000 mm 125
Prijs	€ 150,00

aircraft



Pneumatisch uitdeukhamer voor uitbuilen in carrosserie. Werkt via pneumatische onderdruk op 3 verschillende koppen: ø 60, 120 en 150mm. Met afsluiterkraan.

Order nr.	712402700
Orig. nr.	DBH
Aansluiting	inch 1/4
Luchtverbruik 50% interval	mm 250
Gewicht	kg 1,00
Prijs	€ 173,00

Slagmoersleutels



Slagmoersleutel - Assortiment 1/2".

Kenmerken:

- Links-rechts slagmoersleutel met klein-hamer systeem.
- Geschikt voor licht industriële werk.
- Zijn minimaal eigengewicht, ergonomische vorm en regelbaar koppel garanderen een prima toestel.
- De rubberen hoes rond het handvat verhindert een koude luchtstroom.

Geleverd in een plasticen opbergkoffer.

Order nr.	712401100	
Orig. nr.	SSS1/2	
Aansluiting	inch	1/2
Werkdruk	bar	6
Luchtverbruik	l/min	360
Koppel	ca. Nm	345
Prijs	€	69,50



Slagmoersleutelset 1/2". Dubbelslagsysteem met snelle werking composiet handvat. Met 10 doppen en inline olieverniveelaar. 3-standen (moment instelbaar).

Order nr.	712401220	
Orig. nr.	SET ISS1/2	
Luchtverbruik	l/min	420
Koppel	ca. Nm	560
Maten slagdoppen - standaard	mm	9-10-11-13-14-17-19-22-24-27
Prijs	€	129,00



Compacte slagmoersleutels met hoog moment 1/2". Met composietbehuizing uit slagvaste kunststof.

- Geschikt voor gebruik in montage en industrie.
- Composietbehuizing uit slagvaste kunststof.
- Vibratiearm, isolerend handvat. Werkcomfort ook in koude omstandigheden.
- Laag gewicht en compacte vorm.
- Aandraaimoment verstelbaar in 3 trappen.
- Geen opwaaien van stof door afvoerlucht over de handgreep.

Order nr.	712401400	712401420	712401440	712401450
Orig. nr.	1/2 COM-PACT	1/2 PRO	3/4 PRO	1 PRO
Aansluiting	inch	1/2	3/4	1
Werkdruk	bar	6,3	6,3	6,3
Luchtverbruik	l/min	420	410	510
lastloop				
Luchtverbruik	l/min	530	540	700
leegloop				
Koppel rechtsloop	Nm	270-340-430	300-700-800	350-1100-1350
Koppel linksloop	Nm	540	1080	1620
Snelheid onbelast	tpm	10000	10000	4500
Geluidsniveau	dB(A)	97	97	95
Vibratie	m/s ²	1,2	2,2	3,8
Prijs	€	194,00	215,00	535,00



Standaard slagmoersleutel 3/4" voor zware toepassingen zoals bandencentrales en garages.

- Composietbehuizing uit slagvaste anti-slip kunststof.
- Dubbel hamersysteem voor supersnel werken.
- Vibratiearm, isolerend handvat. Werkcomfort ook in koude omstandigheden.
- Aandraaimoment verstelbaar in 3 trappen.
- Geen opwaaien van stof door afvoerlucht over de handgreep.

Order nr.	712401260	
Orig. nr.	IS 3/4	
Aansluiting	inch	3/4
Werkdruk	bar	6,3
Luchtverbruik lastloop	l/min	510
Koppel rechtsloop	Nm	3 standen - max 1220
Koppel linksloop	Nm	1220
Prijs	€	204,00



Slagmoersleutel met dubbel hamersysteem - industrieuitvoering 1" met composietbehuizing uit slagvaste anti-slip kunststof. Vibratiearm en met laag eigengewicht.

Aandraaimoment rechtsloop instelbaar in 3 trappen.

Order nr.	712401310		
Orig. nr.	IS 1 PRO		
Aansluiting	inch	1"	
Werkdruk	bar	6.3	
Luchtverbruik lastloop	l/min	570	
Koppel rechtsloop	Nm	3 standen - max 2800	
Koppel linksloop	Nm	2800	
Prijs	€	432,00	



Kleine en handige haakse ratel. Instelbare torsie op de kop.

Order nr.	712401500		
Orig. nr.	RS 1/4 PRO		
Aansluiting	inch	1/4	
Werkdruk	bar	6	
Luchtverbruik	l/min	210	
Torsie	Nm	33	
Toerental	tpm	110	
Prijs	€	81,50	



Haakse ratel 1/2". Rubber kop voor krasvrij werken. Ergonomische kunststofgrip voor isolatie tegen vibraties en koude luchtstroom. Eenvoudig instellen van de draairichting.

Order nr.	712401520		
Orig. nr.	RS 1/2 PRO		
Aansluiting	inch	1/2	
Werkdruk	bar	6,3	
Luchtverbruik	l/min	170	
Torsie	Nm	135	
Toerental	tpm	160	
Prijs	€	107,00	



Haakse ratel. Kunststofbektele kop voorkomt schade aan gevoelige werkstukken. Draairichting instelbaar. Ergonomische, vibratie-arme werking. Geïsoleerd composiethandvat.

Order nr.	712401510		
Orig. nr.	RS W 1/2 PRO		
Aansluiting	inch	1/2	
Werkdruk	bar	6.3	
Luchtverbruik	l/min	200	
Toerental	tpm	180	
Maximum torsie	Nm	68	
Prijs	€	113,00	



Haakse slagmoersleutel. Robuust en krachtig, speciaal ontworpen voor professioneel gebruik. Geproduceerd uit staal van hoge kwaliteit. Ergonomisch handvat met rubberen bedekking voor betere grip en isolatie tegen trillingen. Voorzien van een koppeling die 360° draaibaar is, om het gebruiksgemak te verhogen.

Order nr.	205720204		
Orig. nr.	205720204		
Aansluiting	inch	1/2	
Toerental	tpm	240	
Boutcapaciteit	mm	M6-M10	
Maximum torsie	Nm	120	
Aanbevolen torsie	Nm	15-100	
Geluidsniveau (ISO8662:7)	dB(A)	92	
Vibratie (ISO 15744:1999)	m/s ²	0,96	
Luchtaansluiting	G (R)	1/4	
Luchtverbruik (bij 15% interval)	l/min	113	
Lengte	mm	330	
Prijs	€	169,00	



Haakse slagmoersleutel. Ergonomische, rubberen grip voor isolatie tegen koude luchtstroom en vibratie. Koude luchtstroom wordt aan de achterkant weggeleid. Voorzien van een koppeling die 360° draaibaar is, om het gebruiksgemak te verhogen. Links-rechts draaiend. Zeer handig bij gebruik op moeilijk te bereiken plaatsen. De trekker is mooi in het handvat verzonken om een comfortabele grip te garanderen. Speciaal ontworpen voor professioneel gebruik. Vierkante aansluiting geschikt voor slagdoppen (ball-point).

Order nr.	207330200		
Orig. nr.	207330200		
Aansluiting	inch	3/8	
Toerental	tpm	280	
Boutcapaciteit	mm	M10	
Maximum torsie	Nm	34	
Aanbevolen torsie	Nm	8-34	
Geluidsniveau (ISO8662:7)	dB(A)	87,5	
Vibratie (ISO 15744:1999)	m/s ²	2,97	
Minimum maat slang	inch	3/8	
Luchtaansluiting	G (R)	1/4	
Luchtverbruik (bij 15% interval)	l/min	63	
Lengte	mm	165	
Prijs	€	153,00	



Slagmoersleutel met dubbel hamersysteem - industrieuitvoering 1". Lichte alu behuizing. Hoog aandraaimoment.

Order nr.	712401350		
Orig. nr.	1 PRO DUO		
Aansluiting	inch	1	
Werkdruk	bar	6.3	
Luchtverbruik	l/min	9.3	
Koppel	ca. Nm	3000	
Lengte verlengstuk	mm	200	
Prijs	€	875,00	

aircraft



Haakse ratel. Kunststofbeklede kop voorkomt schade aan gevoelige werkstukken. Draairichting instelbaar. Ergonomische, vibratie-arme werking. Geïsoleerd composiethandvat (niet op model RS 1/4).

Order nr.	712401550	
Orig. nr.	LR S 1/2	
Aansluiting	inch	1/2
Werkdruk	bar	6
Luchtverbruik	l/min	390
Koppel	ca. Nm	60
Prijs	€	51,50

TENGOOLS

METAAL



Haakse slagmoersleutel set. Robuust en krachtig, speciaal ontworpen voor professioneel gebruik. Geproduceerd uit staal van hoge kwaliteit. Ergonomisch handvat met rubberen bedekking voor betere grip en isolatie tegen trillingen. De set bevat 7 Teng Tools slagdoppen, waaronder de meest gebruikte maten van 10 tot 19mm, een verlengstuk en een universele koppeling. De set bevat bovendien een mini-olievernevelaar. Geleverd in een handige doos, voorzien van handvat, klikslot en rubberen voetjes om het uitglijden te vermijden.

Order nr.	168880102	
Orig. nr.	TA1217	
Aansluiting	inch	1/2
Toerental	tpm	160
Boutcapaciteit	mm	M6-M10
Maximum torsie	Nm	95
Aanbevolen torsie	Nm	15-90
Geluidsniveau (ISO86627)	dB(A)	91,6
Vibratie (ISO 15744:1999)	m/s ²	4,31
Luchtaansluiting	G (R)	1/4
Luchtverbruik (bij 15% interval)	l/min	86
Lengte	mm	292
Maten slagdoppen	mm	10, 11, 12, 13, 15, 17, 19
Gewicht ratel	kg	1,26
Prijs	€	127,00

TENGOOLS

COMPOSIT



Slagmoersleutel set. TA1221C met behuizing in composiet (omkeerbaar: 3-traps vooruit en 2-traps achteruit). TA1221M met een standaard behuizing. De set bevat 9 Teng Tools slagdoppen, waaronder de meest gebruikte maten van 10 tot 21mm, een verlengstuk en 3 diepe wioldoppen en een mini-olievernevelaar. Geleverd in een handige doos, voorzien van handvat, klikslot en rubberen voetjes om het uitglijden te vermijden.

Order nr.	168870103	
Orig. nr.	TA1221C	
Aansluiting	inch	1/2
Toerental	tpm	8500
Boutcapaciteit	mm	M8-M16
Maximum torsie	Nm	650
Geluidsniveau (ISO8662-7)	dB(A)	97,5
Minimum maat slang	inch	3/8
Luchtaansluiting	G (R)	1/4
Luchtverbruik (bij 15% interval)	l/min	133
Maximum torsie (3 slappen)	Nm	390-520-650
Type hamermechanisme	twin hammer	
Maten slagdoppen - standaard	mm	10, 11, 13, 15, 16, 17, 18, 19, 21
Maten slagdoppen - verlengd	mm	17, 19, 21
Lengte verlengstuk	mm	20x3,5 (2x) - 25x3,5 (2x)
Gewicht ratel	kg	1,9
Prijs	€	252,00

TENGI TOOLS



COMPOSIT

Slagmoersleutel.

Kenmerken:

- Lichte slagmoersleutel met geluidsabsorberend vermogen
- Motorbehuizing uit composiet materiaal
- Ergonomisch rubberen handvat, geïsoleerd tegen kou en trillingen
- 360° draaibare slangaansluiting
- Omkeerbaar - 3 snelheden vooruit en 2 achteruit
- Ontsnappen van de lucht door het handvat, ver van de gebruiker
- Traploze trekker
- Twin hammer mechanisme voor een hoog koppel en een goed uitgebalanceerd aandraaien en losmaken
- Vierkante verbinding met ringslot voor slagdoppen

Geschikt voor professionele werkplaatsen.

Order nr.	168840106	
Orig. nr.	TTDAW12C	
Snelheid onbelast	tpm	8500
Geluidsniveau	dB(A)	97,5
Vibratie	m/s ²	4,42
Boutcapaciteit	mm	M8-M16
Maximum torsie	Nm	720
Minimum maat slang	inch	3/8
Luchtaansluiting	G (R)	1/4
Luchtverbruik (bij 15% interval)	l/min	133
Type hamermechanisme	twin hammer	
Prijs	€	218,00

Beitelhamers

aircraft



Hakhamer - universeel. Lichte en handige hakhamer voor universeel gebruik in plasteiken opbergkoffer. Bevat puntbeitel, platte beitel, rivetten beitel, plaat beitel, universele beitel, veer en olieplu. De zeskantopname vermijdt het ronddraaien van de beitels.

Order nr.	712402200	
Orig. nr.	MHU	
Luchtverbruik	l/min	280
Aantal slagen	rpm	+/- 3000
Gewicht	kg	1,60
Prijs	€	74,50

aircraft



Hakhamer. Lichte en handige hakhamer voor universeel gebruik. Set bevat puntbeitel, platte beitel, rivetten beitel, plaat beitel, universele beitel en veer. De zeskantopname vermijdt het ronddraaien van de beitels. In hoogwaardige kunststofkoffer.

MHV PRO met gebalanceerde anti-vibratie en anti-terugslagtechniek. Ideaal voor verwerken van cellenbeton, baksteen, ... Met snelspanboorkop

Order nr.	712402300	712402400
Orig. nr.	MHB PRO	MHV PRO
Aansluiting	mm	10
Werkdruk	bar	6,3
Luchtverbruik	l/min	240
Aantal slagen	rpm	2200
Gewicht	kg	2,00
Prijs	€	103,00
		204,00

aircraft



Wisselbeitels en accessoires voor de set MHU-MHV-MHB.

Order nr.	Orig. nr.	Omschrijving	Gewicht kg	Prijs €
712402101	2402101	veer	0,06	3,10
712402219	2402219	plaatbeitel 180mm	0,14	8,70
712402227	2402227	platte beitel 20mm/180mm	0,30	6,50
712402382	2402382	platte beitel 30mm/250 mm	0,24	12,50
712402239	2402239	puntbeitel 3mm/175 mm	0,14	6,50
712402381	2402381	puntbeitel 4mm/250 mm	0,20	9,80
712402243	2402243	schraper 50mm/180mm	0,15	13,50
712402383	2402383	schraper 40mm/250 mm	0,24	12,50
712402384	2402384	holle beitel 24mm/240mm	0,26	14,50

aircraft



Zware breekhamer MHA PRO met 3 beitels en veer. Ideaal voor afbraak en renovatiewerken. Beitels 12,7mm: puntbeitel, vlakke beitel en brede vlakke beitel.

Order nr.	712402500	
Orig. nr.	MHA PRO	
Aansluiting	mm	12,7
Werkdruk	bar	6
Luchtverbruik	l/min	380
Aantal slagen	rpm	3600
Gewicht	kg	2,80
Prijs	€	244,00

EQUIPMENT

Handboormachines

aircraft



Rechte en pistoolschroevendraaier met instelbaar aandraaimoment. Links/rechtsloop. Zeskantopname 1/4" met snelwisselkop. Geruisloos door luchtaflaat via verlengde slang.

Order nr.	712404220 M		
Orig. nr.		PS PRO	
Werkdruk	bar	6,3	
Luchtverbruik	l/min	360	
Koppel	ca.	1-12	
Gewicht	kg	1,20	
Prijs	€	239,00	

aircraft



Boormachine links-rechts draaiend met grote snelpanboorkop 1/2" tot 13mm. Trager toerental, geschikt voor grotere werktuigen of boordiameters. Dubbele aandrijving garandeert een rustige loop en langere levensduur. De Luchtuitlaat gebeurt via het handvat om werveling van braamsel te vermijden.

Order nr.	712404170 M		
Orig. nr.		BM 13 PRO	
Toerental onbelast	rpm	450	
Luchtverbruik	l/min	430	
Gewicht	kg	1,60	
Prijs	€	99,50	

Schuurmachines

aircraft



Schuurmachines. Met ergonomisch, vibratiearm handvat. Compact en handig. Voor zowel vlakke als gebogen oppervlakken.

Order nr.	712403500 M	712403450 M	712403520 M	
Orig. nr.	DS	ESS150 PRO	SWS 180 PRO	
Toerental	tpm	11.000	10.000	8.500
Luchtverbruik 50% interval	l/min	480	350	360
Werkdruk maximum	bar	6,3	6,3	6,3
Verplaatsing	mm	3,2	5	3,2
Afmetingen schuurband	mm	70x95	150	100x180
Afzuigpaten		4	6	8
Gewicht	kg	0,80	0,90	1,40
Prijs	€	175,00	208,00	251,00

aircraft



Lange vlakschuurmachine met lineaire schuurbeweging. Voor grote oppervlakken in hout en carrosserie.

Order nr.	712403600 M		
Orig. nr.		BDS PRO	
Toerental	tpm	3000	
Werkdruk maximum	bar	6,3	
Verplaatsing	mm	25	
Afmetingen schuurband	mm	65x390	
Gewicht	kg	2,54	
Prijs	€	99,50	

aircraft



Schuurbanden voor BS PRO en BS 20 PRO.

Order nr.	Orig. nr.	Korrel	Voor type	VE	Min. bestelhoeveelheid	Afmetingen (l x b x h) mm	Prijs/VE €
		K					
712403708 M	2403708	80	BS PRO	5	1	330 x 1 x 10	16,90
712403712 M	2403712	120	BS PRO	5	1	330 x 1 x 10	18,50
712403718 M	2403718	180	BS PRO	5	5	330 x 1 x 10	3,60
712403758 M	2403758	80	BS 20 PRO	1	5		20,50
712403762 M	2403762	120	BS 20 PRO	1	5	520 x 1 x 20	20,50

aircraft



Poliermachine PS7

- Grote haakse poliermachine met vlakke polierschijf
- Extra handgreep voor links- of rechtshandigen
- Schijfdiameter 180mm met klitopname
- Spindel M14x2
- Apart verkrijgbare polierspons (712403292) en polierschijf lamsvel (712403294)

Order nr.	712403290 M		
Orig. nr.		PS7	
Toerental	tpm	2800	
Diameter orbitaal	mm	180	
Luchtverbruik 50% interval	l/min	400	
Werkdruk maximum	bar	6,3	
Omschrijving		Spindelgrote M14x2	
Gewicht	kg	2,20	
Prijs	€	166,00	

aircraft



Universele polijster met diverse gereedschappen, voor het reinigen en polijsten in carrosserie, metaal- en interieurbouw. Vibratie-arm composiethandvat met zijgreep. Geleverd met: 2x draagwiel 11mm en 23mm voor opzetten van schijven, 2x draadborstel fijn 11mm en 23mm en 23mm voor het verwijderen van grove verontreinigingen, roest, verven, lakken en corrosiebeschermingsmiddelen, 1x rubberschijf oker 23mm voor het verwijderen van etiketten, klevers, folie, plakband, ... Alle opzetstukken zijn apart naleverbaar.

Order nr.	712403800	
Orig. nr.	UE PRO	
Werkdruk	bar	6,3
Luchtverbruik	l/min	532
Toerental onbelast	rpm	3500
Prijs	€	394,00

aircraft



Mini polierder PSM3 PRO
 - Handige en compacte poliermachine voor detailwerk
 - Traploos regelbaar toerental
 - Kunststof handgreep voor goede isolatie
 - Luchtafvoer via handgreep, geen extra opwaaiend stof
 - Schijf met klitopname
 - Geleverd met: klitpad ø 76mm, polierspons hard 90 mm (712403281), polierspons zacht 90 mm (712403282), polierschijf lamsvel 80mm (712403283)

Order nr.	712403280	
Orig. nr.	PSM 3 PRO	
Toerental	tpm	2000
Diameter orbitaal	mm	80
Luchtverbruik 50% interval	l/min	340
Werkdruk maximum	bar	6,3
Omschrijving	Spindelopname M6	
Gewicht	kg	0,75
Prijs	€	177,00

aircraft



Draagwiel 11 mm voor UE PRO.

Order nr.	712403840	
Prijs	€	16,90

aircraft



Schuurpapier voor DS schuurmachine van Aircraft.

Order nr.	Orig. nr.	Korrel	Voor type	VE	Min. bestelhoeveelheid	Prijs/VE €
		K				
712403504	2403504	60	DS	1	10	1,40
712403506	2403506	80	DS	1	10	0,90
712403508	2403508	100	DS	1	10	0,70
712403510	2403510	120	DS	1	10	0,70
712403512	2403512	120	DS	1	10	0,70

aircraft



Rubberschijf oker Ø 23 mm voor polijster UE PRO. Voor het verwijderen van etiketten, klevers, folie, plakband, ...

Order nr.	712403810	
Orig. nr.	2403810	
Diameter asgat	mm	23
Voor type	UE PRO	
Prijs	€	22,90

aircraft



Rubberschijf grijs Ø 23 mm voor polijster UE PRO. Voor het verwijderen van wateroplosbare verf.

Order nr.	712403815	
Orig. nr.	2403815	
Diameter asgat	mm	23
Voor type	UE PRO	
Prijs	€	22,90

aircraft



Staaldraadborstel Ø 11 mm, fijne draad (rechte draden, Ø 0,5 mm, verenstaal) voor polijster UE PRO.

Voor reinigen, ontroesten en verwijderen van verf.

Order nr.	712403820	
Orig. nr.	2403820	
Diameter asgat	mm	11
Diameter staaldraad	mm	0,5
Voor type	UE PRO	
Prijs	€	15,50

aircraft



Staaldraadborstel Ø 23 mm, fijne draad (rechte draden, Ø 0,5 mm, verenstaal) voor polijster UE PRO.

Voor reinigen, ontroesten en verwijderen van verf.

Order nr.	712403825	
Orig. nr.	2403825	
Diameter asgat	mm	23
Diameter staaldraad	mm	0,5
Voor type	UE PRO	
Prijs	€	15,50



Staaldraadborstel Ø 11 mm, grove draad (schuine draden Ø 0,7 mm, verenstaal) voor polijster UE PRO.
Voor grovere reiniging. Voor het verwijderen van bodembescherming en afdichtingsmiddel.

Order nr.	712403830		
Orig. nr.	2403830		
Diameter asgat	mm	11	
Diameter staaldraad	mm	0,7	
Voor type	UE PRO		
Prijs	€	15,50	



Staaldraadborstel Ø 23 mm, grove draad (schuine draden Ø 0,7 mm, verenstaal) voor polijster UE PRO.
Voor grovere reiniging. Voor het verwijderen van bodembescherming en afdichtingsmiddel.

Order nr.	712403835		
Orig. nr.	2403835		
Diameter asgat	mm	23	
Diameter staaldraad	mm	0,7	
Voor type	UE PRO		
Prijs	€	15,50	



Dragerwiel Ø 23 mm voor accessoires polijster UE PRO.

Order nr.	712403845		
Orig. nr.	2403845		
Diameter	mm	23	
Voor type	UE PRO		
Prijs	€	16,90	



Grove reinigingsschijf. Voor het verwijderen van verf, kleefstoffen en roest.

Order nr.	712403850		
Orig. nr.	2403850		
Voor type	UE PRO		
Prijs	€	8,30	



Speciaal dragerwiel voor reinigingsschijf 2403850. Enkelvoudige model voor 1 schijf.

Order nr.	712403860		
Orig. nr.	2403860		
Prijs	€	16,90	



Speciaal dragerwiel voor reinigingsschijf 2403850. Dubbele model voor 2 schijven.

Order nr.	712403865		
Orig. nr.	2403865		
Prijs	€	16,90	



Vervangschijf Ø 180 mm met klitopname voor PS7.

Order nr.	712403291		
Orig. nr.	2403291		
Diameter	mm	180	
Prijs	€	19,50	

Slijpers



Terugtrekveer voor ergonomisch werken. Regelbaar.

Order nr.	712106001	712106002
Orig. nr.	2106001	2106002
Belasting	kg 0,4-1,0	1,2
Lengte	m 1,6	1,6
Gewicht	kg 0,70	0,80
Afmetingen (l x b x h)	mm 113 x 113 x 60	
Prijs	€ 49,90	55,50



Band slijper met 360° zwenkbare arm voor moeilijk bereikbare plaatsen. Automatische opspanning van de band.

Order nr.	712403700	712403750
Orig. nr.	BS PRO	BS20PRO
Toerental	tpm 16000	17000
Luchtverbruik 50% interval	mm 400	400
Luchtverbruik 50% interval	l/min 400	400
Werkdruk maximum	bar 6,3	6,3
Afmetingen schuurband	mm 10x330	20x520
Gewicht	kg 0,77	0,84
Prijs	€ 139,00	229,00



Precisie staafslijper set PSS PRO voor polieren en frezen in diverse materialen. Geleverd met 10 slijpstenen, inline olieverniveelaar, olie en aanspan sleutels. Opname 3 mm.

Order nr.	712403120		
Orig. nr.	PSS PRO		
Werkdruk	bar	6,3	
Luchtverbruik	l/min	170	
Toerental onbelast	rpm	54000	
Voor schacht diameter	mm	3	
Prijs	€	79,90	

 aircraft



Haakse slijper met verlengd handvat, perfect voor moeilijk bereikbare plaatsen. instelbare afschermkap verbetert het gericht slijpen. Regelbare luchtstroom op handvat. Geïsoleerd compositiehandvat met veiligheidsknop.

Order nr.	712403490 	
Orig. nr.	TWS PRO	
Werkdruk	bar	6,3
Luchtverbruik	l/min	532
Toerental onbelast voor schijf diam.	rpm	17000
	mm	100
Prijs	€	200,00

 aircraft



Haakse staafslijper voor slijpen, borstelen en afbramen. Zeer compact en licht. Variabel toerental. Met ergonomische handgrip in kunststof voor isolatie tegen vibraties en koude luchtstroom. Set bevat 2 spanklauwen 6 mm en 3mm.

Order nr.	712403210 	
Orig. nr.	WST PRO	
Werkdruk	bar	6,3
Luchtverbruik	l/min	330
Toerental onbelast	rpm	18000
Voor schacht diameter	mm	3-6
Prijs	€	89,00

 aircraft



Set van 4 slijpwalsen en schuurhulzen voor staafslijpers STS Aircraft. ø 9 en 12 mm (schacht 3 mm), en ø 18 en 25 mm (schacht 6 mm).

Order nr.	712403152 	
Orig. nr.	2403152	
Prijs	€	13,90

 aircraft



Set van 5 slijpstiften voor staafslijpers Aircraft. Schacht 3 en 6 mm

Order nr.	712403150 	
Orig. nr.	2403150	
Prijs	€	11,90

 aircraft



Set van 4 schuurhulzen staafslijpers STS Aircraft. ø 9,12,18 en 25mm

Order nr.	712403158 	
Orig. nr.	2403158	
Gewicht	kg	0,02
Prijs	€	3,60

Verfpistolen

 aircraft



Airbrush verfpistoolkit. Sproeier 0,3mm. Voor de kwaliteitsbewuste hobbyist. Eenhandsbediening van verf- en luchtregeling. Met metalen beker van 5cc en 2 glazen bekers van 22 en 50cc. Met 2m leiding, pistoolhouder en koppeling. Verpakt in een handig kunststof doosje.

Order nr.	712101050 	
Orig. nr.	2101050	
Sproeier	mm	0,3
Prijs	€	59,90

 aircraft



Accessoires voor Airbrush verfpistool.

Order nr.	712101052 	
Orig. nr.	2101052	
Omschrijving	naaldset 0,3 mm	
Prijs	€	22,50

 aircraft



Verfpistool met bovenbeker.

Kenmerken:



- Rond of plat regelbare straal.
- Regeling van verfdobiet.
- Veelzijdig inzetbaar in de modelbouw en automobielsector voor moeilijk bereikbare plaatsen.
- Met mini-bovenbeker 100ml.

Order nr.	712101260 	
Orig. nr.	ES	
Luchtverbruik	l/min	30-60
Sproeier	mm	0,5
Werkdruk	bar	1-3
Prijs	€	28,90

 aircraft



Accessoires voor ES verfpistool.

Order nr.	712101265 	712101267 	712101261 
Orig. nr.	2101265	2101267	2101261
Omschrijving	Naaldset 0,5 mm	Naaldset 0,7 mm	Kunststof beker
Prijs	€	11,90	11,90



Verfpistool met bovenbeker 500 ml. Rond of plat regelbare straal. Regeling van verfdébiet. Voor universeel gebruik in industrie en automobielsector.

Order nr.	712101400	
Orig. nr.	SD V	
Luchtverbruik	l/min	100-200
Sproeier	mm	1,5
Werkdruk	bar	3,0-4,5
Prijs	€	22,50



Accessoires voor SD verfpistool.

Order nr.	Orig. nr.	Omschrijving	Prijs €
712101401	2101401	vervangbeker	12,50
712101412	2101412	Naaldset 1,2 mm	16,50
712101415	2101415	Naaldset 1,5 mm	16,50
712101420	2101420	Naaldset 2,0 mm	16,50
712101425	2101425	Naaldset 2,5 mm	16,50



Verfpistool met bovenbeker 750 ml. Rond of plat regelbare straal. Regeling van druk en verfdébiet. Met verfilter. Voor professioneel gebruik in industrie en automobielsector.

Order nr.	712101600	
Orig. nr.	RD HVLP	
Luchtverbruik	l/min	150-200
Sproeier	mm	1,5
Werkdruk	bar	3,5-4,0
Prijs	€	85,50



Accessoires voor HVLP verfpistool.

Order nr.	Orig. nr.	Omschrijving	Prijs €
712101614	2101614	Naaldset 1,4 mm	35,90
712101617	2101617	Naaldset 1,7 mm	35,90
712101620	2101620	Naaldset 2,0 mm	35,90
712101622	2101622	Naaldset 2,2 mm	35,90
712101601	2101601	Plastieken beker 0,75 l	12,50



Verfpistool met bovenbeker 600 ml. Industrieel model. Rond of plat regelbare straal. Diameter naald 1,4 of 2,0mm. Aparte regeling van druk en verfdébiet. Voor professioneel gebruik in industrie en automobielsector.

Order nr.	741761714		741761720	
Orig. nr.	VERF1071.4		VERF1072.0	
Werkdruk minimum	bar	3,5	3,5	
Luchtverbruik	l/min	300	300	
Sproeier	mm	-	-	
Capaciteit beker	l	0,6	0,6	
Prijs	€	88,50	91,90	



Accessoires voor VERF107 verfpistool.

Order nr.	741771400	741772000	741761001
Orig. nr.	VERFNK1.4	VERFNK2.0	VERF107C
Omschrijving	Naaldset 1,4 mm	Naaldset 2,0 mm	Bovenbeker voor VERF107
Prijs	€	41,50	49,50
			22,50



Verfpistool met onderbeker 1000 ml. Industrieel model. Rond of plat regelbare straal. Diameter naald 1,8 of 2,5mm. Aparte regeling van druk en verfdébiet. Voor professioneel gebruik in industrie en automobielsector.

Order nr.	741791800		741792500	
Orig. nr.	VESJ101A1.8		VESJ101A2.5	
Werkdruk minimum	bar	3	3	
Luchtverbruik	l/min	175-300	175-300	
Sproeier	mm	1,8	2,5	
Capaciteit beker	l	1	1	
Prijs	€	96,90	98,50	



Accessoires voor VESJ101A verfpistool.

Order nr.	741801801	741802501	711803001
Orig. nr.	VESJNK1.8	VESJNK2.5	VESJNR1-8P
Omschrijving	Naaldset 1,8 mm	Naaldset 2,5 mm	Onderbeker met deksel
Prijs	€	61,50	50,90
			48,90



VECH1001A

VECH1002A

Verfpistool met extern reservoir (10l) en aanvoerslangen van 3,5m. Rond of plat regelbare straal. Diameter naald 2,5mm. Aparte regeling van verfdebiet. Met manometer en ophanghaak. Type VECH1001A: zonder wielen, geschikt voor solvent-verf. Type VECH1002A: met wielen, geschikt voor én solvent-verf én voor verf op waterbasis.

Order nr.	741711001	741711002
Orig. nr.	VECH1001A	VECH1002A
Luchtverbruik	l/min 230-340	230-340
Sproeier	mm 2,5	2,5
Werkdruk minimum	kg/cm ² 4	4
Tankinhoud	l 10	10
Binnentank	metaal	teflon
Prijs	€ 290,00	339,00



Accessoires voor de verfpistolen VECH1001A en VECH1002A.

Order nr.	Orig. nr.	Omschrijving	Prijs €
998320109	VECH10NKLDT20	naaldset 2,0mm voor VECH1001A	48,90
998320067	VECH10NLDKT	naaldset 2,5mm voor VECH1001A	48,90
747111012	VECH1002AKIT	naaldset 2,5mm voor VECH1002A	48,90
747111014	VECH1002A2	dichting tank	20,90
747111016	VECH1002A4-10	kit aansluiting tank	20,90
747111026	VECH1002A27	wiel	2,10
747111031	VECH1002A-DL	wegwerp-binnentank voor VECH1002A	15,90



SPA Standaard aluminium vernevelpistool met 1 liter beker. Met metalen spuitpijp voor het sproeien van reinigers, ontvetters, oliën. Bajonetsluiting. Met ophanghaak.

Order nr.	712102200
Orig. nr.	SPA
Werkdruk	bar 4-6
Luchtverbruik	l/min +200
Gewicht	kg 0,46
Prijs	€ 18,50



SPA-R Regelbaar aluminium vernevelpistool met 1 liter beker. Met metalen spuitpijp voor het sproeien van reinigers, ontvetters, oliën. Bajonetsluiting. Luchtdebiet en vloeistof zijn regelbaar.

Order nr.	712102220
Orig. nr.	SPA-R
Luchtverbruik	l/min 120-220
Werkdruk	bar 3-6
Prijs	€ 40,50



Zandstraalpistool SPB. Met speciale geharde kop van 6mm en onderbeker van 1 liter.

Order nr.	712103100
Orig. nr.	SPB
Werkdruk minimum	bar 4-8
Luchtverbruik	l/min 250-300
Sproeier	mm 6
Capaciteit beker	l 1
Prijs	€ 25,90



Pistool voor corrosie bescherming in de carrosserie.
 - Met 550 mm sproei flexibel voor het bereiken van moeilijke plaatsen zoals onderaan voertuigen, of in holle ruimtes.
 - Met dikke aanzuigbuis voor weinig vloeibare middelen.
 - Met 40mm draadaansluiting voor gangbare sproeimiddelen.

Order nr.	712104150
Orig. nr.	UHP PRO
Werkdruk	bar 4-6
Luchtverbruik	l/slag 120-180
Prijs	€ 28,90



Reinigingspistool voor de snelle, zachte en grondige reiniging van verschillende materialen zoals textiel, glas, metaal, kunststof, gelakte oppervlakken, ...



Kenmerken:

- Spuitmond met draaiende kop
- Droog of nat gebruik
- Micro-sproeisysteem voor een optimale efficiëntie
- Hoeveelheid reinigingsmiddel traploos regelbaar
- Makkelijk te gebruiken

Order nr.	712102210
Orig. nr.	RP
Werkdruk minimum	bar 6,3
Luchtverbruik	l/min 200
Capaciteit beker	l 0,9
Toerental	min-1 6000
Prijs	€ 150,00

Bouwwerktuigen



Dubbele winkelhaak voor het haaks of aftekenen van 2 zijden tegelijk.

Voordelen:

- Altijd juist en haaks
- Minder tijdverlies
- Minder materiaalverlies

Beschikbaar in 2 maten.

Order nr.	829701002	829701003
Orig. nr.	TM1002	TM1003
Lengte	mm 300x190x190	200x90x90
VE	1	1
Min. bestelhoeveelheid	5	5
Prijs/VE	€ 14,90	13,90



Spanschroef voor metselkoord.

Altijd de juiste hoogte, zonder omkijken

Kenmerken:

- Vastzetten van metselkoord op 2 uiterste stenen
- Gebruikt per paar
- Met 1 draaiknop vastzetten en opspannen
- Beschikbaar in 3 breedtes: 10, 15 of 20 cm

Order nr.	829701004	829701005	829701006
Orig. nr.	TM1010	TM1011	TM1012
Maat	mm 20	15	10
VE	1	1	1
Min. bestelhoeveelheid	4	4	4
Afmetingen (l x b x h)	mm 225 x 50 x 30	175 x 50 x 30	125 x 50 x 30
Prijs/VE	€ 14,90	14,50	13,50

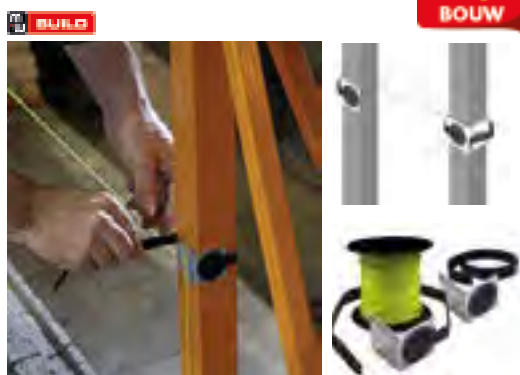

Set van 2 profiel-klemmen met 35m metselkoord.

Voordelen:

- Snel en gemakkelijk opspannen van metselkoord
- Met snelsluiting in Velcro voor het snel veranderen van de hoogte of koordlengte

Order nr.	829701007
Orig. nr.	TM1020
VE	2
Min. bestelhoeveelheid	18
Prijs/VE	€ 13,90



Set van 6 steunen voor bakstenen, betonblokken, enz.

Kenmerken:

- Ondersteunt stenen die uitsteken
- Regelbare schroef, voor diverse hoogtes
- Na droging gemakkelijk te verwijderen door inschroeven
- Geleverd met 2 koplengtes

Order nr.	829701008
Orig. nr.	TM1021
VE	6
Min. bestelhoeveelheid	18
Prijs/VE	€ 39,00

BUILD

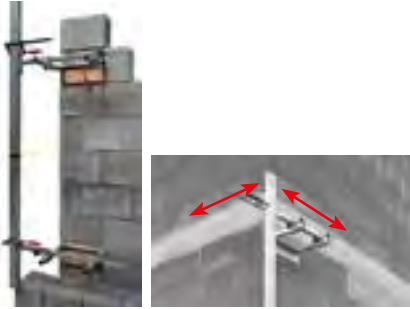

NEW

Set van 4 snelstellers voor metselprofielen.

Voor het metselen van voorgevels en voorzetmuren.

Werking

- De voetplaat van de snelsteller wordt met enkele vijzen vastgezet op de bestaande muur
- Nadien kan het metselprofiel in alle richtingen pas en vast worden gezet

Voordelen

- Geen problemen meer met piketten en klampen
- Werkt sneller, geen tijdverlies
- Heel gemakkelijk werken, steeds nadien aanpasbaar

Kenmerken

- Zowel bij binnen- als buitenhoeken
- Ook voor ronde muren of kolommen

Order nr.	829701010
Orig. nr.	TM1022
VE	4
Prijs/VE	€ 199,00

BUILD



NEW

Voegketel voor stootvoegen

Voordelen:

- Grote inhoud
- Snel en gemakkelijk vullen van verticale voegen
- Beperkt het verlies van mortel
- Ergonomische handgreep
- Verhoogt de werksnelheid

Ideale voegbreedte: 8 mm.

Order nr.	829701009
Orig. nr.	TM1031
Werkbreedte	mm 8
VE	1
Min. bestelhoeveelheid	5
Prijs/VE	€ 27,00

BOUW

BUILD



NEW

Metalen voegplaat met 2 randen.
Voor links- of rechtshandigen.

Order nr.	829701011	829701012
Orig. nr.	TM1032	TM1033
Omschrijving	rechtshandig	linkshandig
VE	1	1
Min. bestelhoeveelheid	3	3
Afmetingen (l x b x h)	mm 354 x 194 x 61	354 x 194 x 61
Prijs/VE	€ 1990	1990

BUILD

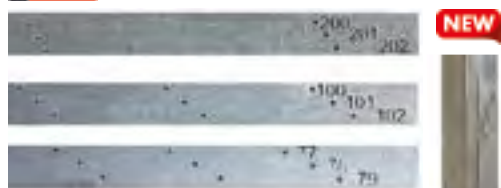

NEW

Stalen lat met standaard lagenmaten.

Wordt op metselprofielen vastgeklemd en vervangt zo het manueel overschrijven van alle lagenmaten.

Kenmerken:

- Ingeponste standaard steenmaten
- 3 versies: 77-78-79 mm, 100-101-102 mm, of 200-201-202 mm
- Wordt per paar gebruikt

Voordelen:

- Werkt veel sneller, geen rekenwerk en tekenwerk meer
- Geen rekenfouten meer
- Wordt op metselprofielen vastgeklemd
- Verhoogt de nauwkeurigheid en snelheid

Order nr.	829701013	829701014	829701015
Orig. nr.	TM1040	TM1041	TM1042
Maat	mm 77-78-79	100-101-102	100-201-202
VE	1	1	1
Min. bestelhoeveelheid	10	10	10
Afmetingen (l x b x h)	mm 1475 x 30 x 2	1475 x 30 x 2	1475 x 30 x 2
Prijs/VE	€ 12,90	12,90	12,90

EQUIPMENT

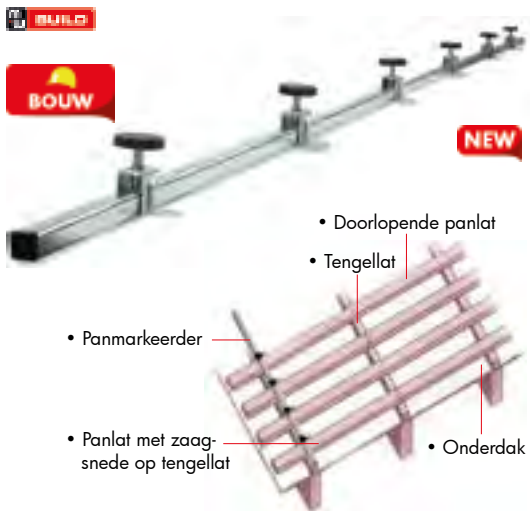

- Doorlopende panlat
- Tengellat
- Panmarkeerder
- Panlat met zaagsnede op tengellat
- Onderdak

Markeerlat 2000 mm voor dakdekkers.

Gemakkelijk overzetten van afstanden zonder te moeten nameten.

Kenmerken:

- Voor het bepalen van de positie van de stofflatten en panlatten
- De lat heeft 5 verstelbare markeercursors
- Voor dakpakken, betonpannen, leien

Order nr.	829701022
Orig. nr.	TM1060
VE	1
Min. bestelhoeveelheid	2
Afmetingen (l x b x h)	mm 2000 x 50 x 50
Prijs/VE	€ 65,00



Stalen schraper voor het egaal uitschrapen van voegen.

Kenmerken:

- 2 schraapkanten voor voegen en stootvoegen
- De hand zit beschermd in de beugel
- Beschikbaar voor verschillende voeghoogtes: 10, 12 en 15 mm

Order nr.	829701023	829701024	829701025
Orig. nr.	TM1065	TM1066	TM1067
Voeghoogte	mm 10	12	15
VE	1	1	1
Min. bestelhoeveelheid	10	10	10
Prijs/VE	€ 27,50	27,50	27,50

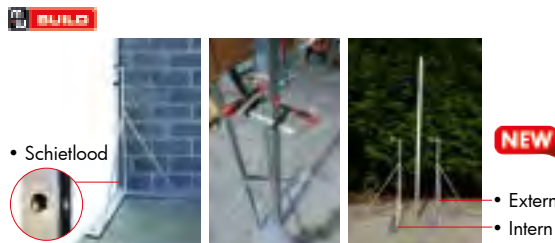

- Schietlood
- Extern
- Intern

Stalen metselprofiel 3000 mm met schietlood binnenin. Pas zetten zonder extra gereedschap.

Hoeksteunen voor vast en pas zetten van metselprofielen

Voordelen:

- 1 persoon kan profielen pas en vast zetten
- Geen problemen meer met piketten en schoren
- Tijdsbesparend systeem

Kenmerken:

- 2 versies: binnen - of buitenhoek
- Vastzetten met enkele betonstenen
- Snel regelbaar met 3 stelschroeven
- Geschikt voor verharde ondergronden

Order nr.	829701026	829701027	829701028
Orig. nr.	TM1070	TM1071	TM1072
Omschrijving	hoeksteun intern voor staand profiel	hoeksteun extern voor staand profiel	staand profiel met schietlood
VE	1	1	1
Min. bestelhoeveelheid	1	1	2
Afmetingen (l x b x h)	mm 1400 x 800 x 800	1400 x 800 x 800	3000 x 50 x 50
Prijs/VE	€ 145,00	145,00	83,00



Dubbele waterpas voor venstertabletten en dorpels.

Met instelschroeven kiest u het gewenste afschot van het tablet.

Voordelen:

- Leg uw tabletten altijd onder dezelfde hoek, zonder nameten
- Werkt veel sneller dan 2 aparte waterpassen
- Zowel voor korte als lange tabletten

Order nr.	829701029
Orig. nr.	TM1073
VE	1
Min. bestelhoeveelheid	3
Prijs/VE	€ 79,00

BUILD

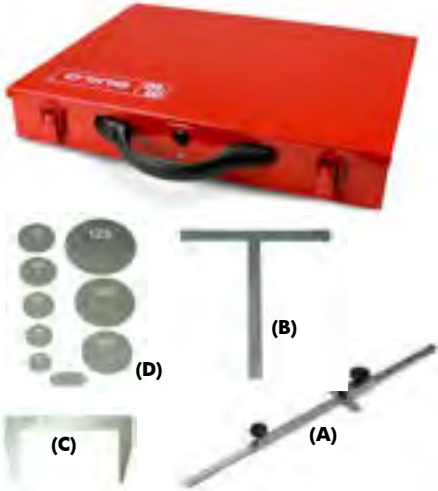

BOUW
NEW

Set van afschrijfgereedschappen voor vloerders en tegelzeters.

Bestaat uit:

- **Kruishout met markeerpunt (A)**
Aftekenen van de snijlijn bij te verzagen tegels.
Bepalen van boorgaten in tegels.
- **T-aanslag met schaalverdeling (B)**
Tegels parallel aan een rand aftekenen.
- **150 mm caliber met 2 bekken (C)**
Afmeten van de positie en diameter van doorvoeren door de tegel.
- **Set 8 traceerschijven met ovaal (D)**
Aftekenen van de laatste rij te verzagen tegels.

Order nr.	829701021	+
Orig. nr.	TM1055	
Prijs	€	239,00

EQUIPMENT

BUILD



NEW

Set 8 traceerschijven met 1 ovaal voor vloerders. Voor het aftekenen van de laatste rij te verzagen tegels en buizen.

Order nr.	829701016	+
Orig. nr.	TM1050	
Afmetingen (l x b x h)	mm	350 x 350 x 2
Prijs	€	150,00

BUILD



NEW

T-aanslag met schaalverdeling voor vloerders. Om tegels parallel aan een rand af te tekenen.

Order nr.	829701017	+
Orig. nr.	TM1051	
VE		4
Afmetingen (l x b x h)	mm	299 x 290 x 30
Prijs/VE	€	35,00

BUILD



NEW

150 mm caliber met 2 bekken. Voor het afmeten van de positie en diameter van doorvoeren door de tegel.

Order nr.	829701018	+
Orig. nr.	TM1052	
Prijs	€	24,00

BUILD



NEW

Kruishout met markeerpunt. Voor het aftekenen van de snijlijn bij te verzagen tegels. Bepalen van boorgaten in tegels.

Order nr.	829701019	+
Orig. nr.	TM1053	
Maximum lengte	mm	759
VE		2
Prijs/VE	€	35,00

Bouwdrogers



Industriële bouwdrogers met opvoerpomp.
Voor het ontvochtigen van diverse lokalen.

Troeven:

- **Hoge capaciteit:** 70 liter of 90 liter per 24 h
- Automatische werking (hygrostaat) of manuele werking
- **afvoerpomp** voert condenswater tot 5 meter hoog af
- Roterende compressor
- Stevige metalen behuizing
- Digitaal display met eenvoudige bediening en timer
- Uitwasbare en herbruikbare luchtfilter

Toepassing:

- Op bouwerven: pleister, beton, dekvloeren, chape, ...
- Bij vochtproblemen na waterlek of overstroming
- Verbeteren van luchtkwaliteit in permanent vochtige ruimtes: kelders, wasruimtes
- Bij vochtgevoelige materialen zoals papier, metaalwaren, houtvoorraad, enz.

Kenmerken:

- Grote schokbestendige PE wielen voor ruw terrein en handige hendel
- Luchtaanvoer via ingang ø 160 mm: met aparte aansuigslang is gericht drogen van extra vochtige plekken mogelijk.
- Inklapbare metalen hendel
- Ingebouwde afvoerpomp met opvoerhoogte 5 m: ideaal voor kelders en bouwputten
- Kan blijven draaien dankzij afvoerpomp, geen beperkende tank
- Automatische ontdooistand
- Stille werking
- Milieuvriendelijk koelmiddel R410A

Voordelen van deze bouwdrogers:

- Tijdbesparend: sneller drogen van pleisters, chapes en beton, vooral in koude en vochtige omstandigheden
- Laat uw bouwplaatsen vele malen sneller uitdrogen
- Kostenbesparend: geen lange wachttijden meer op de werf
- Sneller werven, vloeren, parket leggen, ... zonder risico op restvocht
- Vermijd vocht- en schimmelproblemen
- Optimaal resultaat in combinatie met een MV mobiele ventilator

Order nr.		722313557	722313559
Orig. nr.		BD70P	BD90P
Spanning	V	230	230
Vermogen	W	900	1300
Luchtverplaatsing	cm ³ /h	700	850
Capaciteit	l/24h	70	90
Werktemperatuur	°C	1-40	1-40
Regelbereik luchtvochtigheid	%	35-95	35-95
Capaciteit pomp	W	85	85
Opvoerhoogte pomp	m	5	5
Geluidsniveau	dB(A)	56	56
COP (230V/50Hz)	l/kWh	2,85	2,45
Koelmiddel		R410A	R410A
Afvoer		1/2" slang met snelkoppeling	1/2" slang met snelkoppeling
Automatische ontdooing		✓	✓
Gewicht	kg	45,00	48,50
Afmetingen (l x b x h)	mm	555 x 500 x 1060	555 x 590 x 1060
Prijs	€	649,00	739,00



• Digitaal display

• Schokbestendig



• Opvoerpomp 5 meter



BD70P

• Opklapbaar

• Sterke metalen behuizing

• Filter uitwasbaar

NEW



MACHINES

Waterpompen

MACH

NEW

Pomp met benzinemotor voor vuilwater.

Geleverd met:

- 1 verwijderbare zeef
- 2 uitlaatverbindingen
- 3 klemmen
- 1 bougiesleutel



Order nr.	910000250	910000251	910000252
	€	€	€
Orig. nr.	AGITP50C	AGITP80C	AGITP100C
Diameter afzuiging	mm 50	80	100
Diameter afvoer	mm 50	80	100
Max. debiet vloerniveau	l/min 600	833	1600
Opvoerhoogte	m 28	27	40
Max. afzuighoogte	m 8	8	8
Maximum toerental	rpm 3600	3600	3600
Motor	benzine IT160	benzine IT160	benzine IT240
Vermogen motor	CV 5,5	5,5	8
Cilinderinhoud	cc 163	163	242
Start	startkoord	startkoord	startkoord
Tankinhoud	l 3,6	3,6	4,7
Gewicht	kg 25,00	30,00	47,00
Afmetingen (l x b x h)	mm 465 x 395 x 408	530 x 395 x 459	630 x 500 x 555
Prijs	€ 272,00	299,00	615,00

MACH

NEW

Pomp met benzinemotor voor schoon water.

Geleverd met:

- 1 verwijderbare zeef
- 2 uitlaatverbindingen 45 mm
- 2 uitlaatverbindingen 45 mm
- 4 klemmen 45 mm
- 3 klemmen 45 mm
- 1 bougiesleutel



Order nr.	910000253
	€
Orig. nr.	AGITF50C
Diameter afzuiging	mm 50
Diameter afvoer	mm 50
Max. debiet vloerniveau	l/min 500
Opvoerhoogte	m 55
Max. afzuighoogte	m 6
Maximum toerental	rpm 3600
Motor	benzine IT200
Vermogen motor	CV 6,5
Cilinderinhoud	cc 196
Start	startkoord
Tankinhoud	l 3,6
Gewicht	kg 26,50
Afmetingen (l x b x h)	mm 490 x 400 x 432
Prijs	€ 367,00

MACH

NEW



Afvoerslang voor waterpompen.

Plat oprolbare slang, drie lagen met versterking.

Order nr.	Orig. nr.	Diameter	Lengte	Gewicht	Afmetingen (l x b x h)	Prijs
		mm	m	kg	mm	€
910000257	AGT5250	52	50	27,00	660 x 660 x 90	337,00
910000258	AGT7550	75	50	44,00	700 x 700 x 140	559,00
910000259	AGT5225	52	25	15,00	510 x 510 x 100	201,00
910000260	AGT7525	75	25	22,00	500 x 500 x 120	346,00
910000261	AGT10025	100	25	20,50	500 x 500 x 150	478,00

MACH

NEW



Spiraal zuigslang voor waterpompen.

Veelzijdige flexibele slang, transparant, 3 lagen met versterking.

Order nr.	910000262	910000263	910000264
	€	€	€
Orig. nr.	AGTS5025	AGTS7525	AGTS10025
Diameter	mm 50	75	100
Lengte	m 25	25	25
Gewicht	kg 22,00	33,00	19,00
Afmetingen (l x b x h)	mm 820 x 820 x 230	1250 x 1250 x 270	500 x 500 x 150
Prijs	€ 171,00	309,00	535,00

**NEW**

Pomp met diesel motor voor vuilwater.

Geleverd met:

- 1 verwijderbare zeef
- 2 uitlaatverbindingen 4"/100 mm
- 3 klemmen 4"/100 mm

Order nr.	910000254 €	
Orig. nr.	AGCWD100	
Diameter afzuiging	mm	100
Diameter afvoer	mm	100
Max. debiet vloerniveau	l/min	1600
Opvoerhoogte	m	21
Max. afzuighoogte	m	8
Maximum toerental	rpm	3600
Motor	CF 186 FE	
Vermogen motor	CV	6/8,2
Cilinderinhoud	cc	406
Start	Starter	
Gewicht	kg	51,00
Afmetingen (l x b x h)	mm	680 x 510 x 730
Prijs	€	929,00

**NEW**

Pomp met diesel motor voor schoon water.

Geleverd met:

- 1 verwijderbare zeef
- 2 uitlaatverbindingen 2"/50 mm
- 3 klemmen 2"/50 mm

Order nr.	910000255 €	
Orig. nr.	AGCWD50	
Diameter afzuiging	mm	50
Diameter afvoer	mm	50
Max. debiet vloerniveau	l/min	600
Opvoerhoogte	m	50
Max. afzuighoogte	m	6
Maximum toerental	rpm	3600
Motor	CF 186	
Vermogen motor	CV	6/8,2
Cilinderinhoud	cc	406
Start	Starkkoord	
Gewicht	kg	69,00
Afmetingen (l x b x h)	mm	540 x 485 x 650
Prijs	€	555,00

**NEW**

Waterpomp met diesel motor.

Geleverd met:

- 1 verwijderbare zeef
- 2 uitlaatverbindingen 3"/80 mm
- 3 klemmen 3"/80 mm
- 2 afdichtingen

Order nr.	910000256 €	
Orig. nr.	AGCWD80	
Diameter afzuiging	mm	80
Diameter afvoer	mm	80
Max. debiet vloerniveau	l/min	916
Opvoerhoogte	m	25
Max. afzuighoogte	m	8
Maximum toerental	rpm	3600
Motor	DH170F	
Vermogen motor	CV	6
Start	Starkoord	
Tankinhoud	l	3,5
Gewicht	kg	77,00
Afmetingen (l x b x h)	mm	630 x 485 x 675
Prijs	€	645,00

Trilplaten

TRIL
MILIE



Trilplaat met 4-takt Benzinemotor voor bouw, opritten, tuinaanleg, ...
Verdichten van zand, grind, stabilisé, beton, asfalt, égalisatie, ...

Kenmerken:

- Polyester dempingsmat voor het werken op harde ondergronden (klinkers, bestrating, ...)
- Bescherm- en transport beugel rondom de motor
- Rubber handvat beperkt de vibraties
- Regelbare snelheid voorwaarts

Order nr.	829700000 €	
Orig. nr.	TPT1800	
Verdichtingsvermogen	kN	8
Frequentie	Hz	91.5
Verdichtingsdiepte	cm	25
Verplaatsingssnelheid	m ² /min	0:25
Rendement	m ² /h	450
Afmetingen plaat	mm	450x300
Motor	Benzine 4-takt	
Vermogen motor	kW	2.2
Capaciteit brandstoftank	l	2.4
Klimcapaciteit	°	0-30
Geluidsniveau	dB(A)	102
Gewicht	kg	50,00
Afmetingen (l x b x h)	mm	710 x 360 x 520
Prijs	€	339,00



TRIL
MILIE



Trilplaat met HONDA 4-takt Benzinemotor voor bouw, opritten, tuinaanleg, ...
Verdichten van zand, grind, stabilisé, beton, asfalt, égalisatie, ...

Kenmerken:

- HONDA benzine motor met manuele start
- Polyester dempingsmat voor het werken op harde ondergronden (klinkers, bestrating, ...)
- Bescherm- en transport beugel rondom de motor
- Opklabare transportwielen
- Watertank 10l met grote vuldop, en sproeisysteem over volle plaatbreedte ideaal voor stofbeheersing en voor asfaltwerken
- Rubber handvat beperkt de vibraties
- Regelbare snelheid voorwaarts

Order nr.	829700006 €	
Orig. nr.	TPT1800	
Verdichtingsvermogen	kN	18
Frequentie	Hz	91.5
Verdichtingsdiepte	cm	35
Verplaatsingssnelheid	m ² /min	0-18
Rendement	m ² /h	455
Afmetingen plaat	mm	560x420
Motor	HONDA Benzine 4-takt	
Vermogen motor	kW	4.1
Capaciteit brandstoftank	l	3,6
Klimcapaciteit	°	0:20
Geluidsniveau	dB(A)	103
Wielen		✓
Watertank		✓
Gewicht	kg	90,00
Afmetingen (l x b x h)	mm	760 x 450 x 670
Prijs	€	699,00



- Rubber handvat voorkomt vibraties



- Controle snelheid voorwaarts
- Stalen beschermbeugel voorkomt schade
- Benzinetank
- Afgeschermde transmissieriem
- Centrifuge 5500 RPM
- Rubber dempingsmat voor harde ondergronden
- Gesloten grondplaat
- 4-takt HONDA motor
- Oplegbare transportwielen
- Luchtfilter

Trilplaat met HONDA 4-takt Benzinemotor voor bouw, opritten, tuinaanleg, ...
Verdichten van zand, grind, stabilisé, beton, asfalt, égalisatie, ...

Kenmerken:

- HONDA benzine motor
- manuele start
- Polyester dempingsmat voor het werken op harde ondergronden (klinkers, bestrating, ...)
- Bescherm- en transport beugel rondom de motor
- Oplegbare transportwielen
- Rubber handvat beperkt de vibraties
- Regelbare snelheid voorwaarts

Order nr.	829700003	
Orig. nr.	TPT1200	
Verdichtingsvermogen	kN	12
Frequentie	Hz	91.5
Verdichtingsdiepte	cm	30
Verplaatsingsnelheid	m/min	0-25
Rendement	m ² /h	525
Afmetingen plaat	mm	520X350
Motor	HONDA Benzine 4-takt	
Vermogen motor	kW	4.1
Capaciteit brandstoftank	l	3,6
Klimcapaciteit	°	0-30
Geluidsniveau	dB(A)	104
Wielen		✓
Gewicht	kg	66,00
Afmetingen (l x b x h)	mm	730 x 400 x 630
Prijs	€	619,00

COMPRESSOREN

Klantgerichte planning

Reeds in de planningsfase wordt onze technische afdeling betrokken in de ontwikkeling van nieuwe producten, die zowel in onze werkplaatsen als bij onze partners leveranciers vervaardigd worden. Daardoor worden de behoeften van de markt en van de klanten direct in acht genomen en bevorderen we de ontwikkeling van succesvolle producten.

Toekomstgerichte ontwikkeling

AIRCRAFT producten worden voortdurend verder ontwikkeld, met oog op de toekomst. De ontwikkeling gebeurt met behulp van de nieuwste 3D-CAD-software, door het creëren van een virtueel model. Hier wordt dus aandacht besteed aan de optimale functionaliteit van de ontwikkelingen, en ook aan de herbruikbaarheid van de gegevens.

Ondersteuning fabrikant en leverancier

AIRCRAFT produceert het grootste deel van zijn compressoren in zijn eigen productievestiging in Oostenrijk. Regelmatige werkvergaderingen met onze technici helpen om nieuwe ontwikkelingen en verbeteringen op een gerichte manier in serieproductie in onze werkplaatsen over te dragen. Deze directe ondersteuning bij onze productievestiging is onmisbaar geweest in de productie van kwaliteitsproducten, die onze klanten al bijna 20 jaar vertrouwen.

Praktijkproeven

Onze technische expertise combineert theorie en praktijk. Om niets aan het toeval te laten omtrent de tevredenheid over onze producten, worden op al onze machines en gereedschappen technische testen uitgevoerd. Elk nieuw product moet zich dus eerst in het dagelijkse werk bewijzen, voordat het een vast onderdeel van ons assortiment wordt. De technische analyse helpt ons om de resterende zwakke punten te identificeren en te verwijderen.

Kwaliteitswaarborg

Goed gedocumenteerde kwaliteitscontroles zijn de basis van de constante hoge kwaliteitsproducten. Daarom bevorderen we het begrip kwaliteit in alle afdelingen van ons bedrijf. Regelmatige inspecties zijn een onmisbaar onderdeel van de maatregelen voor kwaliteitsborging. Deskundige medewerkers op het gebied van elektrische, veiligheid- en toepassingstechniek controleren de goederen volgens bepaalde testspecificaties.

Antiroest garantie

Als eerste fabrikant leveren wij onze stationaire compressoren evenals de gehele AIRPROFI serie met verzinkte ketels. Naast de wettelijke garantie, biedt AIRCRAFT op deze ketels 15 jaar garantie tegen doorroesten aan. Ge-poederlakte ketels* zijn standaard geleverd met onze 10 jaar garantie tegen doorroesten.

*Met uitzondering van de compressoren van de bijzonder goedkope E-serie.



Direct aangedreven

 aircraft



NEW

8 BAR

6L

Draagbare, compacte olievrije compressor op 8 Bar.

Troeven:

- Draagbaar en compact
- Olivrij, geen oliewissel meer nodig en geen olie in condenswater
- 8 Bar met tank van 6 liter
- Budgetvriendelijk
- Kwaliteit gegarandeerd

Kenmerken:

- Kwalitatieve elektromotor 230V met een hoog koppel
- Thermische motorbeveiliging beschermt de motor tegen oververhitting
- Volautomatische in- en uitschakeling

Geschikt voor:

- Gebruik in huis, bvb. opblazen zwembaden, banden, etc.
- Instapmodel

Standaard geleverd met:

- Manometer voor werkdruk
- Manometer voor tankdruk
- Gepoederlakte tank
- Schokdempende voetjes met zuignap
- Eenhands snelkoppeling
- Drukregelaar

Order nr.	712001230 	
Orig. nr.	AIRBOY 186 OF E	
Spanning	V	1x230
Aangezogen lucht	l/min	180
Smeersysteem	WDS Olivrij	
Afgegeven lucht	l/min	90
Maximum druk	bar	8
Vermogen motor	kW	1.1
Tankinhoud	l	6
Cilinders/Trappen	1/1	
Toerental	tpm	3400
Geluidsniveau - LWA (0m)	dB(A)	97
Gewicht	kg	9,20
Afmetingen (l x b x h)	mm	315 x 355 x 370
Prijs	€	139,00

OPROLHASPELS

p. 414



 aircraft



NEW

8 BAR

6L

Draagbare, olievrije compressor op 8 Bar.

Troeven:

- Draagbaar
- Olivrij, geen oliewissel meer nodig en geen olie in condenswater
- 8 Bar met tank van 6 liter
- Budgetvriendelijk
- Kwaliteit gegarandeerd

Kenmerken:

- Kwalitatieve elektromotor 230V met een hoog koppel
- Thermische motorbeveiliging beschermt de motor tegen oververhitting
- Volautomatische in- en uitschakeling

Geschikt voor:

- Gebruik in huis, bvb. opblazen zwembaden, banden, etc.
- Instapmodel

Standaard geleverd met:

- Manometer voor werkdruk
- Gepoederlakte tank
- Schokdempende voetjes met zuignap
- Eenhands snelkoppeling
- Drukregelaar

Order nr.	712001235 	
Orig. nr.	AIRBOY 206 OF E	
Spanning	V	1x230
Aangezogen lucht	l/min	180
Smeersysteem	WDS Olivrij	
Afgegeven lucht	l/min	90
Maximum druk	bar	8
Vermogen motor	kW	1.1
Tankinhoud	l	6
Cilinders/Trappen	1/1	
Toerental	tpm	3400
Geluidsniveau - LWA (0m)	dB(A)	97
Gewicht	kg	9,00
Afmetingen (l x b x h)	mm	385 x 170 x 465
Prijs	€	149,00

aircraft



10 BAR

4L

72

Geluidsarme compressor 72 db(A) voor dagelijks gebruik, met kleine tank.

Troeven:

- Geluidsarm 72 db(A)
- Draagbaar
- Olivrij, geen oliewissel meer nodig en geen olie in condenswater
- 10 Bar met tank van 4 liter
- Kwaliteit gegarandeerd

Kenmerken:

- Kwalitatieve elektromotor 230V met een hoog koppel
- Thermische motorbeveiliging beschermt de motor tegen oververhitting
- Volautomatische in- en uitschakeling
- Met de drukregelaar kan deze traploos ingesteld en vastgezet worden

Geschikt voor:

• Bijzonder geluidsarm. Voor gebruik in huis, kantoren en bureaus zoals werken aan electronica, airbrush, ...

Standaard geleverd met:

- Manometer voor werkdruk
- Manometer voor tankdruk
- Gepoederlakte tank
- Schokdempende voetjes met zuignap
- Eenhands snelkoppeling
- Traploos regelbare drukregelaar

Order nr.	71200080	
Orig. nr.	AB SILENCE 40 OF PRO	
Spanning	V	1x230
Aangezogen lucht	l/min	41
Smeersysteem	WDS Olivrij	
Afgegeven lucht	l/min	24
Maximum druk	bar	10
Vermogen motor	kW	250
Tankinhoud	l	4
Cilinders/Trappen	1/1	
Toerental	tpm	2850
Geluidsniveau - LWA (0m)	dB(A)	72
Gewicht	kg	10,20
Afmetingen (l x b x h)	mm	370 x 310 x 300
Prijs	€	249,00

aircraft



8 BAR

9L

43

Geluidsarme compressor 43 db(A) voor dagelijks gebruik, met kleine tank.

Troeven:

- Geluidsarm 43 db(A)
- Draagbaar
- HDS hoog performant olieloosmeersysteem
- 8 Bar met tank van 6 liter
- Kwaliteit gegarandeerd

Kenmerken:

- Kwalitatieve elektromotor 230V met een hoog koppel
- Thermische motorbeveiliging beschermt de motor tegen oververhitting
- Volautomatische in- en uitschakeling
- Traploos regelbare drukregeling van 0 tot 8 bar

Geschikt voor:

• Bijzonder geluidsarm. Voor gebruik in huis, kantoren en bureaus zoals werken aan electronica, airbrush, ...

- Servicewagens, installateurs, etc.

Standaard geleverd met:

- Manometer voor werkdruk
- Gepoederlakte tank
- Schokdempende voetjes met zuignap
- Eenhands snelkoppeling
- Traploos regelbare drukregelaar

Order nr.	712000100	
Orig. nr.	AIRBOY SILENCE50PRO	
Spanning	V	230
Aangezogen lucht	l/min	50
Smeersysteem	gekapseld	
Afgegeven lucht	l/min	33
Maximum druk	bar	8
Vermogen motor	kW	0,340
Tankinhoud	l	9
Cilinders/Trappen	1/1	
Toerental	tpm	2900
Geluidsniveau - LWA (0m)	dB(A)	43
Gewicht	kg	21,00
Afmetingen (l x b x h)	mm	320 x 320 x 480
Prijs	€	825,00



10 BAR

2,4L

Draagbare, compacte compressor voor dagelijks gebruik, met minitank en 10 bar.

Troeven:

- Draagbaar en compact
- HDS hoog performant olieloosmeersysteem
- 10 Bar met minitank van 2,4 liter
- Kwaliteit gegarandeerd

Kenmerken:

- Kwalitatieve elektromotor 230V met een hoog koppel
- Thermische motorbeveiliging beschermt de motor tegen oververhitting
- Volautomatische in- en uitschakeling
- Traploos regelbare drukregeling van 0 tot 10 bar

Geschikt voor:

- Voor gebruik in huis, kantoren en bureaus zoals werken aan electronica, airbrush, ...

Standaard geleverd met:

- Manometer voor werkdruk
- Manometer voor tankdruk
- Gepoederlakte tank
- Schokdempende voetjes met zuignap
- Eenhands snelkoppeling
- Traploos regelbare drukregelaar

Order nr.	712001245	
Orig. nr.	AIRBOY 261E	
Spanning	V	230
Aangezogen lucht	l/min	260
Smeersysteem	HOS	
Afgegeven lucht	l/min	170
Maximum druk	bar	10
Vermogen motor	kW	1,8
Tankinhoud	l	2,4
Cilinders/Trappen	1/1	
Toerental	tpm	2850
Geluidsniveau - LWA (0m)	dB(A)	97
Gewicht	kg	22,00
Afmetingen (l x b x h)	mm	510 x 270 x 400
Prijs	€	269,00



15 BAR

2,4L

Draagbare, compacte compressor voor dagelijks gebruik, met minitank en 15 bar.

Troeven:

- Draagbaar en compact
- HDS hoog performant olieloosmeersysteem
- 15 Bar met minitank van 2,4 liter
- Kwaliteit gegarandeerd
- 10 jaar garantie op ketel tegen doorroesten

Kenmerken:

- Kwalitatieve elektromotor 230V met een hoog koppel
- Thermische motorbeveiliging beschermt de motor tegen oververhitting
- Volautomatische in- en uitschakeling
- Traploos regelbare drukregeling van 0 tot 15 bar

Geschikt voor:

- gebruik in huis, kantoren en bureaus zoals werken aan electronica, airbrush, ...

Standaard geleverd met:

- Manometer voor werkdruk
- Manometer voor tankdruk
- Gepoederlakte tank.
- Schokdempende voetjes met zuignap
- Eenhands snelkoppeling
- Traploos regelbare drukregelaar

Order nr.	712001237	
Orig. nr.	AIRBOY KITT 90	
Spanning	V	230
Smeersysteem	HOS	
Afgegeven lucht	l/min	49
Maximum druk	bar	15
Vermogen motor	kW	0,6
Tankinhoud	l	2,4
Cilinders/Trappen	1/1	
Toerental	tpm	1420
Geluidsniveau - LWA (0m)	dB(A)	85
Gewicht	kg	21,00
Afmetingen (l x b x h)	mm	510 x 270 x 400
Prijs	€	505,00

Zaircraft



8 BAR

6L

Olievrije, draagbare compressor voor dagelijks gebruik, 8 bar met kleine tank 6 liter.

Troeven:

- Draagbaar en compact
- Olivrij model: geen olie in luchtdruk en condenswater en daardoor zuiverder en milieuvriendelijker
- 8 Bar met kleine tank van 6 liter
- Kwaliteit gegarandeerd

Kenmerken:

- Kwalitatieve elektromotor 230V met een hoog koppel
- Thermische motorbeveiliging beschermt de motor tegen oververhitting
- Volautomatische in- en uitschakeling
- Traploos regelbare drukregeling van 0 tot 8 bar

Geschikt voor:

- Gebruik in huis, kantoren en bureaus zoals werken aan electronica, airbrush, ...
- Veeleisende hobbist
- Montagedoeleinden

Standaard geleverd met:

- Manometer voor werkdruk
- Manometer voor tankdruk
- Gepoederlakte tank
- Schokdempende voetjes met zuignap
- Eenhands snelkoppeling
- Traploos regelbare drukregelaar
- Drukschakelaar

Order nr.	712001210	
Orig. nr.	HANDY 201OF	
Spanning	V	230
Aangezogen lucht	l/min	179
Smeersysteem	WDS	
Afgegeven lucht	l/min	110
Maximum druk	bar	8
Vermogen motor	kW	1,1
Tankinhoud	l	6
Cilinders/Trappen		1/1
Toerental	tpm	2850
Geluidsniveau - LWA (0m)	dB(A)	91
Gewicht	kg	11,50
Afmetingen (l x b x h)	mm	330 x 255 x 500
Prijs	€	149,00

Zaircraft



8 BAR

24L

Mobiele, olievrjze compressor 8 bar met tank 24 liter. Universeel inzetbaar.

Troeven:

- Mobiel, dankzij groot gedimensioneerde wielen
- Olivrij model: geen olie in luchtdruk en condenswater en daardoor zuiverder en milieuvriendelijker
- 8 Bar met tank van 24 liter
- Budgetvriendelijk
- Kwaliteit gegarandeerd

Kenmerken:

- Kwalitatieve elektromotor 230V met een hoog koppel
- Thermische motorbeveiliging beschermt de motor tegen oververhitting
- Volautomatische in- en uitschakeling
- Traploos regelbare drukregeling van 0 tot 8 bar

Geschikt voor:

- Gebruik in huis, kantoren en bureaus zoals werken aan electronica, airbrush, ...
- Veeleisende hobbist
- Montagedoeleinden

Standaard geleverd met:

- Manometer voor werkdruk
- Manometer voor tankdruk
- Gepoederlakte tank
- Schokdempende voetjes met zuignap
- Eenhands snelkoppeling
- Traploos regelbare drukregelaar
- Drukschakelaar

Order nr.	712002222	
Orig. nr.	MBOY 221/24 OF	
Spanning	V	230
Aangezogen lucht	l/min	200
Smeersysteem	WDS	
Afgegeven lucht	l/min	110
Maximum druk	bar	8
Vermogen motor	kW	1,5
Tankinhoud	l	24
Cilinders/Trappen		1/1
Toerental	tpm	2850
Geluidsniveau - LWA (0m)	dB(A)	94
Gewicht	kg	24,00
Afmetingen (l x b x h)	mm	570 x 255 x 590
Prijs	€	167,00

aircraft



8 BAR

24L

Mobiele, hoog rendement olieloozmeersysteem compressor 8 bar met tank 24 liter. Universeel inzetbaar.

Troeven:

- Mobiel, dankzij groot gedimensioneerde wielen
- HDS hoog performant olieloozmeersysteem
- 8 Bar met tank van 24 liter
- Kwaliteit gegarandeerd

Kenmerken:

- Kwalitatieve elektromotor 230V met een hoog koppel.
- Thermische motorbeveiliging beschermt de motor tegen oververhitting.
- Volautomatische in- en uitschakeling.
- Traploos regelbare drukregeling van 0 tot 8 bar

Geschikt voor:

- Gebruik in huis, kantoren en bureaus zoals werken aan electronica, airbrush, ...
- veeleisende hobbist
- montagedoeleinden

Standaard geleverd met:

- Manometer voor werkdruk
- Manometer voor tankdruk
- Gepoederlakte tank.
- Schokdempende voetjes met zuignap.
- Eenhands snelkoppeling
- Traploos regelbare drukregelaar
- Drukschakelaar

Order nr.	712002241	
Orig. nr.	MBOY 241/24 E	
Spanning	V	230
Aangezogen lucht	l/min	200
Smeersysteem	HOS	HOS
Afgegeven lucht	l/min	110
Maximum druk	bar	8
Vermogen motor	kW	1,5
Tankinhoud	l	24
Cilinders/Trappen		1/1
Toerental	tpm	2850
Geluidsniveau - LWA (0m)	dB(A)	93
Gewicht	kg	23,00
Afmetingen (l x b x h)	mm	570 x 255 x 590
Prijs	€	139,00

OPROLHASPELS

p. 414



aircraft



10 BAR

24L

Mobiele, hoog rendement olieloozmeersysteem compressor 10 bar met tank 24 liter. Universeel inzetbaar.

Troeven:

- Mobiel, dankzij groot gedimensioneerde wielen
- HDS hoog performant olieloozmeersysteem
- 10 Bar met tank van 24 liter
- Kwaliteit gegarandeerd

Kenmerken:

- Kwalitatieve elektromotor 230V met een hoog koppel
- Thermische motorbeveiliging beschermt de motor tegen oververhitting
- Volautomatische in- en uitschakeling
- Traploos regelbare drukregeling van 0 tot 10 bar

Geschikt voor:

- Gebruik in huis, kantoren en bureaus zoals werken aan electronica, airbrush, ...
- Veeleisende hobbist
- Montagedoeleinden

Standaard geleverd met:

- Manometer voor werkdruk
- Manometer voor tankdruk
- Gepoederlakte tank
- Schokdempende voetjes met zuignap
- Eenhands snelkoppeling
- Traploos regelbare drukregelaar
- Drukschakelaar

Order nr.	712003326	
Orig. nr.	MBOY 301/24 E	
Spanning	V	230
Aangezogen lucht	l/min	260
Smeersysteem	HOS	HOS
Afgegeven lucht	l/min	170
Maximum druk	bar	10
Vermogen motor	kW	1.8
Tankinhoud	l	24
Cilinders/Trappen		1/1
Toerental	tpm	2850
Geluidsniveau - LWA (0m)	dB(A)	97
Gewicht	kg	26,00
Afmetingen (l x b x h)	mm	580 x 310 x 615
Prijs	€	313,00

aircraft



10 BAR

50L

Mobiele, hoog rendement olieloozmeersysteem compressor 10 bar met tank 50 liter. Universeel inzetbaar.

Troeven:

- Mobiel, dankzij groot gedimensioneerde wielen
- HDS hoog performant olieloozmeersysteem
- 10 Bar met tank van 50 liter
- Kwaliteit gegarandeerd

Kenmerken:

- Kwalitatieve elektromotor 230V met een hoog koppel
- Thermische motorbeveiliging beschermt de motor tegen oververhitting
- Volautomatische in- en uitschakeling
- Traploos regelbare drukregeling van 0 tot 10 bar

Geschikt voor:

- gebruik in huis, kantoren en bureaus zoals werken aan electronica, airbrush, ...
- veeleisende hobbist
- montagedoeleinden

Standaard geleverd met:

- Manometer voor werkdruk
- Manometer voor tankdruk
- Gepoederlakte tank
- Schokdempende voetjes met zuignap
- Eenhands snelkoppeling
- Traploos regelbare drukregelaar
- Drukschakelaar

Order nr.	712003331 ^M		
Orig. nr.	MBOY 311/50E		
Spanning	V	230	
Aangezogen lucht	l/min	284	
Smeersysteem	HOS		
Afgegeven lucht	l/min	190	
Maximum druk	bar	10	
Vermogen motor	kW	2,2	
Tankinhoud	l	50	
Cilinders/Trappen		1/1	
Toerental	tpm	2850	
Geluidsniveau - LWA (0m)	dB(A)	97	
Gewicht	kg	36,50	
Afmetingen (l x b x h)	mm	870 x 350 x 700	
Prijs	€	377,00	

aircraft



10 BAR

50L

Mobiele compressor met twee hoogwaardige cilinders 10 bar met tank 50 liter. Universeel inzetbaar.

Troeven:

- Twee hoogwaardige cilinders, V aggregaat
- Mobiel, dankzij groot gedimensioneerde wielen
- HDS hoog performant olieloozmeersysteem
- 10 Bar met tank van 50 liter
- Kwaliteit gegarandeerd

Kenmerken:

- Kwalitatieve elektromotor 230V met een hoog koppel
- Thermische motorbeveiliging beschermt de motor tegen oververhitting
- Volautomatische in- en uitschakeling
- Traploos regelbare drukregeling van 0 tot 10 bar

Geschikt voor:

- Gebruik in huis, kantoren en bureaus zoals werken aan electronica, airbrush, ...
- Veeleisende hobbist
- Montagedoeleinden

Standaard geleverd met:

- Manometer voor werkdruk
- Manometer voor tankdruk
- Gepoederlakte tank
- Schokdempende voetjes met zuignap
- Eenhands snelkoppeling
- Traploos regelbare drukregelaar
- Drukschakelaar

Order nr.	712003650 ^M		
Orig. nr.	MBOY 361/50 E		
Spanning	V	230	
Aangezogen lucht	l/min	356	
Smeersysteem	HOS		
Afgegeven lucht	l/min	215	
Maximum druk	bar	10	
Vermogen motor	kW	2,2	
Tankinhoud	l	50	
Cilinders/Trappen		2/1	
Toerental	tpm	2850	
Geluidsniveau - LWA (0m)	dB(A)	97	
Gewicht	kg	38,00	
Afmetingen (l x b x h)	mm	870 x 350 x 700	
Prijs	€	299,00	



Zeer compacte, mobiele werfcompressor 10 bar met tank van 10L

Troeven:

- HOS Oliegesmeerd voor zware bedrijfsomstandigheden
- Sterk frame beschermt alle componenten.
- Licht en gemakkelijk draagbaar.
- 10 Bar met tank van 10 liter
- Kwaliteit gegarandeerd

Kenmerken:

- Kwalitatieve elektromotor 230V met een hoog koppel.
- Thermische motorbeveiliging beschermt de motor tegen oververhitting.
- Volautomatische in- en uitschakeling.
- Traploos regelbare drukregeling van 0 tot 10 bar

Geschikt voor:

- werven
- montagedoeleinden

Standaard geleverd met:

- Manometer voor werkdruk
- Manometer voor tankdruk
- Gepoederlakte tank.
- Kunststof banden en zuignappen vooraan.
- Eenhands snelkoppeling
- Traploos regelbare drukregelaar
- Automatische drukschakelaar
- Aluminium drukleidingen

Tip: ook beschikbaar in 8 bar, 712005220

Order nr.	712005261 ^M	
Orig. nr.	COMPACT-AIR 265/10 E	
Spanning	V	230
Aangezogen lucht	l/min	250
Smeersysteem	HOS	
Afgegeven lucht	l/min	155
Maximum druk	bar	10
Vermogen motor	kW	1,5
Tankinhoud	l	10
Cilinders/Trappen		1/1
Toerental	tpm	2850
Geluidsniveau - LWA (0m)	dB(A)	96
Gewicht	kg	22,00
Afmetingen (l x b x h)	mm	395 x 320 x 630
Prijs	€	293,00



10 BAR
10L

Mobiele, olievrije compressor BX 10 bar met 24 l ketel voor dagelijkse montagedoeleinden

Troeven:

- HDS BX met patenteerd hoog performant olieeloos smeersysteem, met horizontale zuigers. Dit boxermotor-principe vermindert merkbaar de slijtage in vergelijking met klassieke compressoren. De olievrije compressor zorgt voor een goede arbeidskwaliteit en een lange levensduur van het pneumatische gereedschap
- Model BX240 SILENT met uiterst geluidsarme werking (65dB)
- Onderhoudsvrij
- Licht en gemakkelijk transporteerbaar.
- 10 Bar met ketel van 24 liter
- Hoog debiet door dubbele V-cilinder.
- Met laag toerental 1.400 min-1
- Kwaliteit gegarandeerd
- Met 10 jaar garantie tegen doorroesten tank



Kenmerken:

- Bescherming tegen oververhitting voor continu gebruik
- Rustige loop met laag toerental garandeert een lange levensduur
- Kwaliteit elektromotor met zachte aanloop en thermische veiligheid
- Motor voorzien van een veiligheidsschakelaar
- Volautomatisch aan- en uitschakelen
- Uitgerust met alle veiligheidsvoorzieningen

Geschikt voor:

- Dagelijks, intensief gebruik.
- Licht, compact en hoog debiet: ideaal voor vaklui onderweg of op bouwvelden.
- Ook geschikt als compacte werkplaatscompressor
- Groot luchtdebiet, bestemd voor continu gebruik door lage opwarming

Standaard geleverd met:

- Manometer voor tankdruk
- Gepoederlakte tank.
- Kunststof banden en zuignappen vooraan.
- 1 eenhands snelkoppeling EURO
- Traploos regelbare drukregelaar
- Automatische CONDOR drukschakelaar
- Aluminium drukleidingen

Order nr.	712005310 ^M	712005301 ^M
Orig. nr.	COMPACT-AIR BX 240OF	COMPACT-AIR BX330OF
Spanning	V	230
Aangezogen lucht	l/min	240
Smeersysteem	HDS	HDS
Afgegeven lucht	l/min	150
Maximum druk	bar	10
Vermogen motor	kW	1,5
Tankinhoud	l	24
Cilinders/Trappen		2/1
Toerental	tpm	1400
Geluidsniveau - LWA (0m)	dB(A)	78
Geluidsniveau - LPA (1m)	dB(A)	65
DINISO3744		80
Gewicht	kg	34,00
Afmetingen (l x b x h)	mm	500 x 560 x 810
Prijs	€	809,00

DE AIRCRAFT COMPRESSOREN: POMPSYSTEMEN

WDS - olieloos



WDS-olieleze smering

- Een zuigerring uit Teflon neemt bij WDS systeem de taak over van de normale zuigerring uit staal.
- Een smering met mineraalolie is niet meer nodig.

Voordelen van het WDS systeem

- Oliewissel en -controle vallen weg.
- Gunstige oplossing door een beperkt aantal eenvoudige onderdelen.
- Ideale oplossing bij kleine behoefte aan luchtdruk.

HDS - olieloos

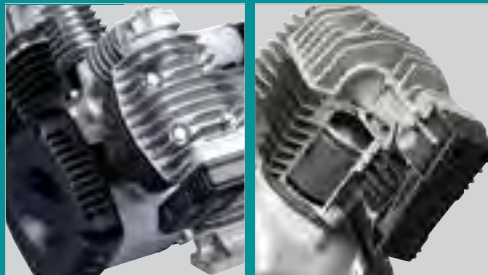

HDS - Hoog performant, olieeloos smeersysteem

- Ontworpen voor continu gebruik, telkens als schone en olievlrije perslucht nodig is.
- Grote zuiger op beweegbare lager gemonteerd, biedt tot 60% meer vermogen in vergelijking met systemen met oscillerende zuiger.
- Zeer precieze en gladde zuigeroppervlakken voor minimale wrijving.
- Hoogwaardige zuiger en zuigerring uit speciale legering van grafiet, Teflon en koolstof voor een langere levensduur dan een gewone Teflon zuigerring.

Voordelen van het HDS systeem

- Levensduur tot 50 keer langer in vergelijking met gewone onderhoudsvrije systemen met oscillerende zuiger.
- De grote koellamellen in combinatie met de zuiger uit een stuk vervaardigd zorgen voor een optimale warmteafvoer.
- Onderhoudsvrij.
- Ideaal overall waar schone en olievlrije perslucht nodig is in dagelijks gebruik.

HOS



HOS - Het systeem met oliesmering voor zware bedrijfsomstandigheden.

De precies afgewerkte zuigers zijn voorzien van 2 dichtingen die de zuigerwand perfect afdichten. Het carter is gevuld met olie en de smering gebeurt door de olie die wordt rondgeworpen door de slag van de cilinder/krukas. Een afdichting/schraper veegt de geoliede zuigerwand af naar onder.

De voordelen van het HOS systeem:

- Perfecte smering en een optimale afdichting.
- Hoge bedrijfszekerheid en lange levensduur.
- Zeer onderhoudsvriendelijk. De ideale compressor voor het zware professionele gebruik.

HDS - MODEL BX



**NEW
GEPATENTEERDE TECHNIEK**

HDS - Hoog performant, olieeloos smeersysteem

- Ontworpen voor continu gebruik, telkens als schone en olievlrije perslucht nodig is.
- Grote zuiger op beweegbare lager gemonteerd, biedt tot 60% meer vermogen in vergelijking met systemen met oscillerende zuiger.
- Op het BX model heeft de zuiger een axiale beweging, zoals een boxermotor – gepatenteerde technologie voor een aanzienlijke vermindering van slijtage (zie afbeelding).
- De zuiger heeft een axiale beweging in een speciale cilinder met keramische coating.
- Dit vermindert aanzienlijk de slijtage van de afdichtingen.
- Dit systeem voorkomt frequent en kostbaar onderhoud dat noodzakelijk is op conventionele droge compressoren.

Voordelen van het smeersysteem HDS BX

- De gepatenteerde olievlrije compressor met dubbele zuiger en de horizontale compressie, vermindert de slijtage aanzienlijk in vergelijking met de conventionele olievlrije compressoren.
- De grote koellamellen in combinatie met de zuiger uit een stuk vervaardigd zorgen voor een optimale warmteafvoer.
- Onderhoudsvrij.
- Ideaal overall waar schone en olievlrije perslucht nodig is in dagelijks gebruik.



COMPACT-AIR311/20E



COMPACT-AIR361/20E



COMPACT-AIR321/20

Zeer compacte, mobiele werfcompressor 10 bar met tank van 20L

Troeven:

- HOS Oliegesmeerd voor zware bedrijfsomstandigheden
- Sterk frame beschermt alle componenten.
- Frontaal bedieningspaneel.
- Licht en gemakkelijk draagbaar.
- 10 Bar met tank van 20 liter
- Hoog debiet door dubbele V-cilinder (modellen 361/20E en 321/20).
- Model 321/20 met laag toerental 1.420 min⁻¹ en V-pomp
- Kwaliteit gegarandeerd
- Model 311/20 en 321/20 met 10 jaar garantie tegen doorroesten tank

Kenmerken:

- Kwalitatieve elektromotor 230V met een hoog koppel.
- Thermische motorbeveiliging beschermt de motor tegen oververhitting.
- Volautomatische in- en uitschakeling.
- Traploos regelbare drukregeling van 0 tot 10 bar

Geschikt voor:

- werven
- montagedoeleinden

Standaard geleverd met:

- Manometer voor werkdruk
- Manometer voor tankdruk
- Gepoederlakte tank.
- Kunststof banden en zuignappen vooraan.
- Eenhands snelkoppeling
- 2 eenhands snelkoppelingen bij 311/20 en 321/20
- Traploos regelbare drukregelaar
- Automatische CONDOR drukschakelaar bij 311/20 en 321/20
- Model 361/20E aluminium drukleidingen
- Model 311/20 en 321/20 koperen drukleidingen

Order nr.		712005291 ^M	712005361 ^M	712005300 ^M
Orig. nr.		COMPACT-AIR 311/20E	COMPACT-AIR 361/20 E	COMPACT-AIR 321/20
Spanning	V	230	230	230
Aangezogen lucht	l/min	284	356	310
Smeersysteem		HOS	HOS	HOS
Afgegeven lucht	l/min	190	215	240
Maximum druk	bar	10	10	10
Vermogen motor	kW	2,2	2,2	2,2
Tankinhoud	l	20	20	20
Cilinders/Trappen		1/1	2/1	2/1
Toerental	tpm	2850	2850	1420
Geluidsniveau - LWA (0m)	dB(A)	97	97	96
Gewicht	kg	33,50	37,00	39,50
Afmetingen (l x b x h)	mm	470 x 490 x 720	470 x 490 x 720	470 x 490 x 720
Prijs	€	429,00	440,00	1.025,00



10 BAR
2x10L

Mobiele, olievrije compressor BX 10 bar met 2 x 10 l ketel voor dagelijkse montage doeleinden

Troeven:

- HDS BX met patenteerd hoog performant olieloos smeersysteem, Dit boxermotor-principe vermindert merkbaar de slijtage in vergelijking met klassieke compressoren. De olievrije compressor zorgt voor een goede arbeidskwaliteit en een lange levensduur van het pneumatische gereedschap
- Onderhoudsvrij
- Licht en gemakkelijk transporteerbaar.
- 10 Bar met 2 ketels van elk 10 liter
- Hoog debiet door dubbele V-cilinder.
- Met laag toerental 1.400 min⁻¹
- Kwaliteit gegarandeerd
- Met 10 jaar garantie tegen doorroesten tank

Kenmerken:

- Bescherming tegen oververhitting voor continu gebruik
- Rustige loop met laag toerental garandeert een lange levensduur
- Kwaliteit elektromotor met zachte aanloop en thermische veiligheid
- Motor voorzien van een veiligheidsschakelaar
- Volautomatisch aan- en uitschakelen
- Uitgerust met alle veiligheidsvoorzieningen

Geschikt voor:

- dagelijks gebruik op werven en montage doeleinden
- het gebruik van gereedschap met hoog luchtverbruik, met lage aanloopstroom, bvb plasmasnijden
- Ideaal in werkomgevingen waar zeer zuivere lucht vereist wordt, of bij lage temperaturen

Standaard geleverd met:

- Manometer voor werkdruk
- Manometer voor tankdruk
- Gepoederlakte tank.
- Kunststof banden en zuignappen vooraan.
- 2 eenhands snelkoppelingen
- Traploos regelbare drukregelaar
- Automatische CONDOR drukschakelaar
- Aluminium drukleidingen

Order nr.	712005400	
Orig. nr.	AIRCAR BX330 OF	
Type	HDS	
Spanning	V	230
Aangezogen lucht	l/min	330
Afgegeven lucht	l/min	200
Maximum druk	bar	10
Vermogen motor	kW	1,7
Tankinhoud	l	2 x 10
Cilinders/Trappen		2/1
Toerental	tpm	1400
Gewicht	kg	50,00
Afmetingen (l x b x h)	mm	670 x 545 x 570
Prijs	€	1.039,00



10 BAR
2x10L

AIRCAR 553/22PRO

AIRCAR 321/22PRO

Zware werfcompressor met oliesmering 10 bar met hoog debiet en complete uitrusting, 2 ketels van 11 liter.

Troeven;

- HOS met oliesmering voor zware bedrijfsomstandigheden
- 10 Bar met 2 ketels van elk 11 liter
- Hoog debiet door dubbele V-cilinder
- Met laag toerental 1.420 min⁻¹
- Kwaliteit gegarandeerd
- Met 10 jaar garantie tegen doorroesten tank

Kenmerken:

- Groot luchtdebiet, bestemd voor continu gebruik
- Robuust frame met werkvlak bovenaan
- Rustige loop door laag toerental garanderen lange levensduur
- Kwaliteits elektromotor met zachte aanloop en thermische veiligheid
- Automatisch aan- en uitschakelen
- Bescherming tegen oververhitting voor continu gebruik
- Brede wielbasis garandeert stabiliteit en veilig transport

Geschikt voor:

- Bouwwerven of als verplaatsbare werkplaatscompressor
- Het gebruik van gereedschap met hoog luchtverbruik, met lage aanloopstroom, bvb plasmasnijden
- Ideaal in werkomgevingen waar zeer zuivere lucht vereist wordt, of bij lage temperaturen

Standaard geleverd met:

- Manometer voor werkdruk
- Manometer voor tankdruk
- Gepoederlakte tank
- Grote PU-schuimbanden voorkomen lekke band
- 3 veiligheids EURO+ORION snelkoppelingen
- 3 aftappunten: 1x gefilterd, 1x gefilterd en geolied, 1x ongefilterd vanuit het drukvat
- Traploos regelbare drukregelaar
- Automatische CONDOR drukschakelaar, luchtfilter en olieverevelaar
- Gepantserde drukleidingen voorkomen verbranding en breuk door vibratie
- 2 handgrepen, kabel en slanghaken in het frame

Order nr.	712005531	712005553	
Orig. nr.	AIRCAR 321/22PRO	AIRCAR 553/22PRO	
Spanning	V	230	3x400
Aangezogen lucht	l/min	310	550
Smeersysteem	HOS		HOS
Afgegeven lucht	l/min	240	410
Maximum druk	bar	10	10
Vermogen motor	kW	2,2	3
Tankinhoud	l	22 (2x11)	22 (2x11)
Cilinders/Trappen		2/1	2/1
Toerental	tpm	1420	1420
Geluidsniveau - LWA (0m)	dB(A)	91	94
Geluidsniveau - LPA (1m)	dB(A)	75	81
DINISO3744			
Gewicht	kg	53,00	77,00
Afmetingen (l x b x h)	mm	780 x 685 x 670	780 x 685 x 670
Prijs	€	1.279,00	1.789,00

MACHINES

Riemaangedreven

 aircraft

10 BAR 14 BAR

2x10L 100L



AIRCAR 652/100B



AIRCAR 500/20B

Zuigercompressoren met Honda benzinemotor voor gebruik op de bouwwerf, depannage, landbouw, ...

Troeven:

- 4 en 6,6kW 4-takt Hondamotor maakt het mogelijk onafhankelijk van stroomgroepen te blijven werken.
- Zware pomp met groot debiet geschikt voor zware belasting.
- Werkdruk tot 14 bar (model AIRBAU 652/100 B PRO) voor langer vullen van banden.
- Automatische regeling van toerental en vrijloopventiel bij veranderende belasting.
- De zware gietijzeren pomp en laag toerental garanderen een rustige loop en lange levensduur
- Optimale koeling door groot loopwiel en koelribben beperken condensvorming in de tank
- Stabiele metalen beschermgrille

Geschikt voor:

- op de bouwwerf, depannage, landbouw, ...
- werkomgevingen zonder elektriciteit

Geleverd met:

- Kwalitatieve EURO-snelkoppeling en CONDOR drukschakelaar
- Kwaliteits elektromotor met zachte aanloop en thermische veiligheid
- Automatisch aan- en uitschakelen
- Grote PU-banden kunnen niet leeglopen.
- Gepoederlakte ketel met 10 jaar garantie

Order nr.		712006530 	712005500 
Orig. nr.		AIRBAU 652/100B	AIRCAR 500/20B
Aangezogen lucht	l/min	642	500
Smeersysteem		HOS	HOS
Afgegeven lucht	l/min	480	390
Maximum druk	bar	14	10
Vermogen motor	kW	6,6	4
Tankinhoud	l	100	20 (2x10)
Cilinders/Trappen		2/2	2/1
Toerental	tpm	950	1375
Geluidsniveau - LWA (0m)	dB(A)	99	97
Gewicht	kg	121,00	81,00
Afmetingen (l x b x h)	mm	1050 x 500 x 1060	750 x 700 x 950
Prijs	€	2.615,00	1.879,00



AIRSTAR 401/50 E - 403/50 E



AIRSTAR 401/90E



Mobiele compressoren riemaandrijving 10 bar en 2-cilinder aggregaat met gietijzer koelribben, met tank 50 of 90 liter.

Troeven:

- Riemaandrijving
- HOS Oliegesmeerd voor zware bedrijfsomstandigheden
- Twee hoogwaardige cilinders, V aggregaat
- Mobiel, dankzij groot gedimensioneerde wielen
- 10 Bar met tank van 50 (Model Airstar 401/90E 90 liter)
- Prijsgunstige uitvoering
- Kwaliteit gegarandeerd
- Model 403/50E op 3x400V met fasenwisselaar.

Kenmerken:

- Elektromotor met hoog koppel en overbelastingsschakelaar.
- Nakoeler met koellamellen beperkt condensvorming.
- Rustige loop door laag toerental garanderen lange levensduur
- Volautomatische in- en uitschakeling via drukschakelaar.
- Traploos regelbare drukregeling van 0 tot 10 bar

Geschikt voor:

- dagelijks gebruik op werven en montage doeleinden
- het gebruik van gereedschap met hoog luchtverbruik, met lage aanloopstroom, bvb plasmasnijden
- Ideaal in werkomgevingen waar zeer zuivere lucht vereist wordt, of bij lage temperaturen

Standaard geleverd met:

- Manometer voor werkdruk
- Manometer voor tankdruk
- Gepoederlakte tank.
- Kunststof banden en zuignappen vooraan.
- 1 eenhands snelkoppeling
- Traploos regelbare drukregelaar
- Automatische drukschakelaar
- Aluminium drukleidingen

Order nr.		712008312	712009413	712009433	712009414
Orig. nr.		AIRSTAR 321/50 E	AIRSTAR 401/50E	AIRSTAR 403/50E	AIRSTAR401/90E
Spanning	V	230	230	3x400	230
Aangezogen lucht	l/min	235	365	365	365
Smeersysteem		HOS	HOS	HOS	HOS
Afgegeven lucht	l/min	185	266	266	266
Maximum druk	bar	10	10	10	10
Vermogen motor	kW	1,5	2,2	2,2	2,2
Tankinhoud	l	50	50	50	100
Cilinders/Trappen		2/1	2/1	2/1	2/1
Toerental	tpm	1040	1375	1375	1375
Geluidsniveau - LWA (0m)	dB(A)	92	94	94	94
Gewicht	kg	48,50	50,00	57,50	59,00
Afmetingen (l x b x h)	mm	870 x 400 x 700	870 x 400 x 700	870 x 400 x 700	870 x 500 x 780
Prijs	€	339,00	515,00	559,00	569,00

SERIE AIRSTAR: PROFESSIONELE

Hoogwaardige pomp met HOS-smering

- De gietijzeren hoogwaardige tweecilinder aggregaat in combinatie met het lage toerental zorgt voor een hoge bedrijfszekerheid en een lange levensduur.
- De nakoeler met grote koellamellen zorgt voor een lage ingangstemperatuur aan de ketel.



- **Kwaliteitselektromotor** met motorbeveiliging tegen oververhitting en overbelasting beschermd.
- Condensator en ontlastingsventiel verzekeren een zachte aanloop op de 230 V modellen.



Aansluiting

- Aansluitingskabel met stekker.
- 400V modellen met fasen omvormer voor gemakkelijke handmatige omkering van de draairichting.

- **Verdeelbox** met schroefverbindingen
- De werkdruk is traploos instelbaar aan de filter drukregelaar, met simultane afscheiding van vuil, olie en condensaat.
- 2 grote manometers tonen de werkdruk en de druk in de ketel aan.
- Standaard uitgerust met veiligheidsnelkoppelingen, met één hand te bedienen.
- Standaard uitgerust met een hoogwaardige CONDOR drukregelaar.



- Lange hendel voor gemakkelijk rechtop verplaatsen van de compressor.
- Geen belasting van de rug door optillen.

- De rubberen handgreep voorkomt wegglijden.

- Comfortabel transport dankzij zwenk wielen met rem.
- De rem voorkomt de draai- en rolbewegingen van de wielen, voor een optimale stabiliteit van de compressor.

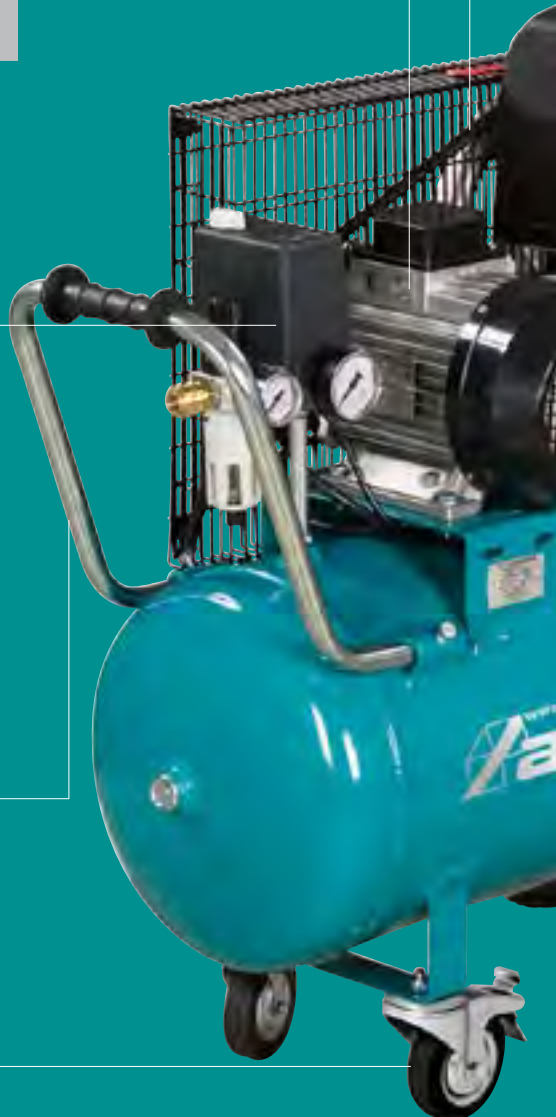

RIEMAANGEDREVEN COMPRESSOREN



- **Krachtige en zuinige aandrijving**
- Gelande aandrijfriem voor een eenvoudig opstarten, rustigere loop en betere krachtoverbrenging, en vermindert opbrengstverliezen tot 30%.
- De grote ventilator en koelribben op de cilinder zorgen voor een optimale koeling van de pomp.
- Het metalen riemdekseel zorgt voor een optimale bescherming van de componenten en voor de veiligheid van de gebruiker.



- Roestvrije platen aan het ontlastingsventiel voor een betere warmte-afvoer en een lange levensduur van de compressor.

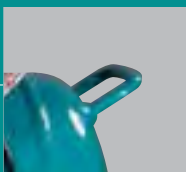

- **Handig transportgreep op de ketel.**

- Gepantserde flexibele slang met bescherming tegen de hitte voor een lange levensduur, zodat geen breuk door vibraties mogelijk is.
- De terugslagklep zorgt voor een zachte aanloop.

- Hoogwaardige gepoederlakte ketel voor een lange levensduur.
- Beschikbaar in 50, 100 en 200 liter.



- De grote volle wielen met PU-schuim en de rem zorgen voor een comfortabel transport, omdat de compressor niet opgetild moet worden.



10 BAR

50L



AIRSTAR 401/50 - 403/50



AIRSTAR 503/50

Mobiele compressoren met tank 50 tot 200 liter voor de veeleisende professional.

Kenmerken:

- Riemaandrijving met groot loopwiel en 2-cilinder aggregaat met gietijzer koelribben.
- Flexibele pantserleiding bestand tegen vibratie.
- Elektromotor met hoog koppel en overbelastingsschakelaar.
- Grote nakoeler met koellamellen beperkt condensvorming.
- Grote, volle banden en draaiwielen en rem vooraan.
- Met gefilterde drukregelaar, dubbele manometer, RECTUS snelkoppeling en condensaflaat.
- Volautomatische in- en uitschakeling via CONDOR drukschakelaar.
- Gepoederlakte ketel met grote ergonomische transportbeugel. 10 jaar garantie op doorroesten.

Compleet aansluitklaar geleverd. Standaard uitgerust met alle veiligheidsdelen.

Modellen 3x400V met fasenwisselaar.

Modellen met tank 270 liter op aanvraag.

Order nr.		712009410 ^M	712009430 ^M	712009530 ^M
Orig. nr.		AIRSTAR 401/50	AIRSTAR 403/50	AIRSTAR 503/50
Spanning	V	230	3x400	3x400
Aangezogen lucht	l/min	390	390	510
Smeersysteem		HOS	HOS	HOS
Afgegeven lucht	l/min	285	285	400
Maximum druk	bar	10	10	10
Vermogen motor	kW	2,2	2,2	3
Tankinhoud	l	50	50	50
Cilinders/Trappen		2/1	2/1	2/1
Toerental	tpm	1490	1490	1310
Geluidsniveau - LWA (0m)	dB(A)	96	96	94
Gewicht	kg	57,50	65,00	65,00
Afmetingen (l x b x h)	mm	860 x 440 x 800	860 x 440 x 880	860 x 440 x 880
Prijs	€	755,00	789,00	905,00

aircraft



AIRSTAR 401/100

Mobiele compressoren met tank 100 tot 200 liter.

Kenmerken:

- Riemaandrijving met groot loopwiel en 2-cilinder aggregaat met gietijzer koelribben
- Flexibele pantserleiding bestand tegen vibratie
- Elektromotor met hoog koppel en overbelastingsschakelaar
- Grote nakoeler met koellamellen beperkt condensvorming
- Grote, PU gevulde banden en draaiwielen en rem vooraan
- Met gefilterde drukregelaar, dubbele manometer, RECTUS snelkoppeling en condensaflaat
- Volautomatische in- en uitschakeling via CONDOR drukschakelaar
- Gepoederlakte ketel met grote ergonomische transportbeugel. 10 jaar garantie op doorroesten

Compleet aansluitklaar geleverd. Standaard uitgerust met alle veiligheidsdelen

Model 3x400V met fasenwisselaar

Order nr.		712007411 ^M	712007421 ^M	712009432 ^M
Orig. nr.		AIRSTAR 401/100	AIRSTAR 401/200	AIRSTAR 403/200
Spanning	V	230	230	3x400
Aangezogen lucht	l/min	390	390	390
Smeersysteem		HOS	HOS	HOS
Afgegeven lucht	l/min	285	285	285
Maximum druk	bar	10	10	10
Vermogen motor	kW	2,2	2,2	2,2
Tankinhoud	l	100	200	200
Cilinders/Trappen		2/1	2/1	2/1
Toerental	tpm	1490	1490	1490
Geluidsniveau - LPA (1m) DINISO3744	dB(A)	96	96	96
Gewicht	kg	69,00	94,00	96,00
Afmetingen (l x b x h)	mm	1080 x 500 x 780	1200 x 640 x 1020	1425 x 580 x 925
Prijs	€	795,00	1.039,00	1.069,00

Aircraft



10 BAR

100L

200L

AIRSTAR 503/100



Volle banden

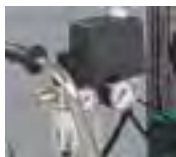

Drukregelaar



Nakoeler

MACHINES

Mobiele compressoren met tank 50 tot 200 liter voor de veeleisende professional.

- Riemaandrijving met groot loopwiel en 2-cilinder aggregaat met gietijzer koelribben.
- Flexibele pantslerleiding bestand tegen vibratie.
- Elektromotor met hoog koppel en overbelastingsschakelaar.
- Grote nakoeler met koellamellen beperkt condensvorming.
- Grote, volle banden en draaiwielen en rem vooraan.
- Met gefilterde drukregelaar, dubbele manometer, RECTUS snelkoppeling en condensaflaat.
- Volautomatische in- en uitschakeling via CONDOR drukschakelaar.
- Gepoederlakte ketel met grote ergonomische transportbeugel. 10 jaar garantie op doorroesten.
- Compleet aansluitklaar geleverd.
- Standaard uitgerust met alle veiligheidsdelen.
- Modellen 3x400V met fasenwisselaar.
- Modellen met tank 270 liter op aanvraag.

Order nr.		712009531 ^M	712007623 ^M	712009731 ^M
Orig. nr.		AIRSTAR 503/100	AIRSTAR 503/200	AIRSTAR 703/100
Spanning	V	3x400	3x400	3x400
Aangezogen lucht	l/min	510	510	650
Smeersysteem		HOS	HOS	HOS
Afgegeven lucht	l/min	400	400	520
Maximum druk	bar	10	10	10
Vermogen motor	kW	3,0	3,0	4
Tankinhoud	l	100	200	100
Cilinders/Trappen		2/1	2/1	2/2
Toerental	tpm	1310	1310	950
Geluidsniveau - LWA (0m)	dB(A)	94	94	79
Gewicht	kg	79,00	85,00	99,00
Afmetingen (l x b x h)	mm	1125 x 480 x 925	1180 x 600 x 900	1125 x 480 x 1015
Prijs	€	999,00	1.159,00	1.419,00



AIRSTAR 853/100

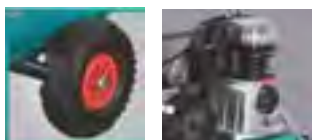

10 BAR
100L 200L

Mobiele compressoren met tank 50 tot 200 liter voor de veeleisende professional.

Kenmerken:

- Riemaandrijving met groot loopwiel en 2-cilinder aggregaat met gietijzer koelribben.
- Flexibele pantserleiding bestand tegen vibratie.
- Elektromotor met hoog koppel en overbelastingsschakelaar.
- Grote nakoeler met koellamellen beperkt condensvorming.
- Grote, volle banden en draaiwielen en rem vooraan.
- Met gefilterde drukregelaar, dubbele manometer, RECTUS snelkoppeling en condensaflaat.
- Volautomatische in- en uitschakeling via CONDOR drukschakelaar.
- Gepoederlakte ketel met grote ergonomische transportbeugel. 10 jaar garantie op doorroesten.

Compleet aansluitklaar geleverd. Standaard uitgerust met alle veiligheidsdelen.

Modellen 3x400V met fasenwisselaar.

Modellen met tank 270 liter op aanvraag.

Order nr.	712009831 ^M	712009832 ^M
Orig. nr.	AIRSTAR 853/100	AIRSTAR 853/200
Spanning	V 3x400	400
Aangezogen lucht	l/min 850	850
Smeersysteem	HOS	HOS
Afgegeven lucht	l/min 680	680
Maximum druk	bar 10	10
Vermogen motor	kW 5,5	5,5
Tankinhoud	l 100	200
Cilinders/Trappen	2/2	2/2
Toerental	tpm 1240	1240
Geluidsniveau - LWA (0m)	dB(A) 95	95
Gewicht	kg 112,00	65,00
Afmetingen (l x b x h)	mm 1125 x 480 x 1015	1190 x 680 x 1150
Prijs	€ 1.525,00	1.635,00



AIRPROFI 401/50 - 403/50

10 BAR
50L
PRO

AIRPROFI 503/50

Professionele montagecompressor met verzinkte tank voor de veeleisende gebruiker.

Kenmerken:

- Kwaliteitselektromotor met een hoog koppel wordt door een overbelastingsschakelaar beschermd tegen oververhitting en overbelasting.
- 3x400V met fasewisselknop in de stekker.
- Hoogwaardige CONDOR drukschakelaar voor volautomatische in- en uitschakeling.
- Verdeelblok met drukregelaar en 2 grote manometers voor druk op het vat en op de uitgangen.
- 2 aftakpunten met gefilterde lucht en al dan niet geolieide lucht.
- 2 EURO veiligheids-snelkoppelingen voor het drukloos ontkoppelen van gereedschappen.
- Met aftakkraan aan de ketel.
- Mobiele met grote stabiele PU-schuimgevulde banden en rubber handgreep.
- Betrouwbare riemaandrijving en een hoogwaardige 2-cilinder luchtaggregate vervaardigd uit aluminium/gietijzer.
- De Nakoeler met grote koellamellen. Flexibele, gepantereerde en hittebestendige slangleiding is bestand tegen vibratiebreuken.

Compleet aansluitklaar geleverd. Standaard uitgerust met alle veiligheidsvoorzieningen. Gebouwd volgens de geldende CE-normen.

Order nr.	712018410 ^M	712018430 ^M	712018530 ^M
Orig. nr.	AIRPROFI 401/50	AIRPROFI 403/50	AIRPROFI 503/50
Spanning	V 230	3x400	3x400
Aangezogen lucht	l/min 365	390	510
Smeersysteem	HOS	HOS	HOS
Afgegeven lucht	l/min 266	285	400
Maximum druk	bar 10	10	10
Vermogen motor	kW 2,2	2,2	3
Tankinhoud	l 50	50	50
Cilinders/Trappen	2/1	2/1	2/1
Toerental	tpm 1375	1360	1310
Geluidsniveau - LWA (0m)	dB(A) 96	96	95
Gewicht	kg 56,00	56,00	66,00
Afmetingen (l x b x h)	mm 810 x 430 x 790	810 x 430 x 790	860 x 440 x 880
Prijs	€ 899,00	875,00	1.049,00

MACHINES

10 BAR 13 BAR
75L 100L 200L
PRO

AIRPROFI 503



AIRPROFI 703

Professionele montagecompressor met verzinkte tank 100 of 200 liter voor de veeleisende gebruiker.

Kenmerken:

- Kwaliteitselectromotor met een hoog koppel wordt door een overbelastingsschakelaar beschermd tegen oververhitting en overbelasting.
- 3x400V met fasewisselknop in de stekker.
- Hoogwaardige CONDOR drukschakelaar voor volautomatische in- en uitschakeling.
- Verdeelblok met drukregelaar en 2 grote manometers voor druk op het vat en op de uitgangen.
- 2 aftakpunten met gefilterde lucht en al dan niet geolieerde lucht.
- 2 EURO veiligheids-snelkoppelingen voor het drukloos ontkoppelen van gereedschappen.
- Met aftakkraan aan de ketel.
- Mobiele met grote stabiele PU-schuimgevulde banden en rubber handgreep.
- Betrouwbare riemaandrijving en een hoogwaardige 2-cilinder luchttaggregaat vervaardigd uit aluminium/gietijzer.
- De Nakoeler met grote koellamellen. Flexibele, gepantere en hittebestendige slangleiding is bestand tegen vibratiebreuken.
- Compleet aansluitklaar geleverd. Standaard uitgerust met alle veiligheidsvoorzieningen. Gebouwd volgens de geldende CE-normen.
- 270 liter tank op aanvraag.

Order nr.	712018531	712018731	712018831	712018832	712018734	712018735
Orig. nr.	AIRPROFI 503/100	AIRPROFI 703/100	AIRPROFI 853/100	AIRPROFI 853/200	AIRPROFI 703/75/13	AIRPROFI 703/100/15
Spanning	V 3x400	3x400	3x400	3x400	3x400	3x400
Aangezogen lucht	l/min 510	650	850	850	575	575
Smeersysteem	HOS	HOS	HOS	HOS	HOS	HOS
Afgegeven lucht	l/min 400	520	680	680	460	460
Maximum druk	bar 10	10	10	10	13	13 (15)
Vermogen motor	kW 3,0	4	5,5	5,5	4	4
Tankinhoud	l 100	100	100	200	75	100
Cilinders/Trappen	2/1	2/2	2/2	2/2	2/2	2/2
Toerental	tpm 1310	950	1240	1240	850	850
Geluidsniveau - LWA (0m)	dB(A) 93	93	95	95	93	94
Gewicht	kg 76,00	99,00	112,00	139,00	103,00	109,00
Afmetingen (l x b x h)	mm 1080 x 500 x 940	1120 x 480 x 960	1275 x 480 x 1015	1190 x 680 x 1150	1020 x 440 x 1015	1275 x 480 x 1015
Prijs	€ 1.165,00	1.489,00	1.649,00	1.749,00	1.725,00	1.735,00

Stationair

aircraft



AIRSTAR 703/270H



AIRSTAR 703/270V

10 BAR

270L

Stationaire driefasige compressor met gepoederlakte ketel.

Kenmerken:

- Hoge prestaties op een kleine oppervlakte, ontwikkeld voor intensief gebruik.
- Tweecilinderige compressorkop uit gietijzer met rustige loop.
- Grote koellamellen en vliegwiel. Hoogwaardig filterpatroon zorgt voor zuivere aanzuiglucht.
- Kwaliteits elektromotor met overbelastingsschakelaar.
- 3 luchtafname-uitgangen op de ketel.
- Gebouwd volgens de geldende CE-normen.
- Met CONDOR drukschakelaar.

Model 270V met een plaatsbesparende verticale ketel van 270 liter.

Model 270H met horizontale ketel van 270 liter.

Order nr.		712028753	712028752
Orig. nr.		AIRSTAR 703/270 H	AIRSTAR 703/270 V
Spanning	V	3x400	3x400
Aangezogen lucht	l/min	650	650
Smeersysteem		HOS	HOS
Afgegeven lucht	l/min	520	520
Maximum druk	bar	10	10
Vermogen motor	kW	4	4
Tankinhoud	l	270	270
Cilinders/Trappen		2/2	2/2
Toerental	tpm	950	950
Geluidsniveau - LPA (1m) DINISO3744	dB(A)	80	80
Gewicht	kg	160,00	160,00
Afmetingen (l x b x h)	mm	1950 x 600 x 1250	720 x 720 x 1770
Prijs	€	1.569,00	1.835,00



AIRPROFI 853/100/10H



AIR-
PROFI703/75/13H



AIRPROFI BK
703/13/10

10 BAR 13 BAR
4KW 5,5KW
13L 75L 100L
PRO

Compacte bijzetcompressoren met kleine druktank voor piekbehoeften.
Ook inzetbaar tijdens werkzaamheden aan andere compressoren in een systeem.

Kenmerken:

- Heel compact, met toch serieus luchtdebiet. Perfect voor kleine compressorlokalen of als tijdelijke oplossing.
- Modellen met tankinhoud 13, 75 of 100 liter, werkdruk 10 of 13 bar
- Aansluitbaar op elk netwerk. Met aftapkraan.
- Kan ook worden aangesloten op de Aircraft mobiele tankbatterijen (zie toebehoren)
- Kwalitatieve compressorpomp voor intensief gebruik. Het lage toerental garandeert een rustige, trillingsvrije loop
- Optimale koeling door groot loopwiel en koelribben beperken condensvorming in de tank
- Lage warmteontwikkeling, lange levensduur.
- Gepantserde, flexibele drukleiding voorkomt afbreken van de leiding.
- Thermische motorbeveiliging tegen overbelasting. Aanloopontlasting beperkt de stroompiek.
- Verzinkte ketel, ook vanbinnen, geeft de beste garantie tegen doorroesten.
- CONDOR druschakelaar, manometer en overdrukventiel
- 100 liter-modellen met veiligheids-snelkoppeling voor zowel ORION als EURO nippels. Drukloos en veilig aan- en afkoppelen.
- Driefasige kwaliteitsmotor 3x400V.

Geleverd met trillinasdempers

Order nr.		712022273 M	712022283 M	712022275 M	712029711 M	712029911 M
Orig. nr.		AIRPROFI 703/100	AIRPROFI 853/100	AIRPROFI 703/75/13	AIRPROFI BK703/13/10	AIRPR BK1003/13/10
Spanning	V	3x400	3x400	3x400	3x400	3x400
Aangezogen lucht	l/min	650	850	575	650	960
Smeersysteem		HOS	HOS	HOS	HOS	HOS
Afgegeven lucht	l/min	520	680	460	520	750
Maximum druk	bar	10	10	13	10	10
Vermogen motor	kW	4	5,5	4	4	5,5
Tankinhoud	l	100	100	75	13	13
Cilinders/Trappen		2/2	2/2	2/2	2/2	2/2
Toerental	tpm	950	1240	850	950	1060
Geluidsniveau - LPA (1m) DINISO3744	dB(A)	83	83	79	83	83
Luchtdrukaansluiting	inch	1/2	1/2	3/4	3/4	3/4
Gewicht	kg	99,00	112,00	103,00	55,00	80,00
Afmetingen (l x b x h)	mm	1120 x 460 x 960	1120 x 460 x 960	850 x 460 x 960	685 x 745 x 675	685 x 790 x 745
Prijs	€	1.489,00	1.595,00	1.725,00	1.575,00	2.099,00



2025712

10 BAR
4KW 5,5KW 7,5KW
270L 300L 500L
PRO



WE AC 1/4"



Condensafleider Bekomat 31 (712049049)

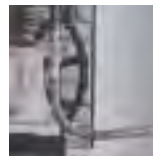

Stationaire zuigercompressoren met druktank van 300 of 500 liter en debiet tot 1200l/min.

Kenmerken

- Grote hoeveelheid druklucht direct beschikbaar.
- Kwalitatieve 2-cilinder compressorpomp voor intensief gebruik. Het lage toerental garandeert een rustige, trillingsvrije loop
- Optimale koeling door groot loopwiel en koelribben beperken condensvorming in de tank
- Lage warmteontwikkeling, lange levensduur.
- Gepantserde, flexibele drukleiding voorkomt afbreken van de leiding.
- Thermische motorbeveiliging tegen overbelasting. Aanlooptasting beperkt de stroompiek.
- Verzinkte ketel, ook vanbinnen, geeft de beste garantie tegen doorroesten.
- CONDOR drukschakelaar, manometer en overdrukventiel

Geleverd met:

- Trillingsdempers
- Driefasige kwaliteitsmotor 3x400V. Model 7,5kW geleverd met ster-driehoekschakelaar en bedrijfsurenteller
- Aansluitklaar geleverd.

Order nr.		712025712 M	712025813 M	712025815 M	712025915 M	712026015 M
Orig. nr.		2025712	AIRPROFI 853/300/10H	AIRPROFI 853/500/10H	AIRPR 1003/500/10H	AIRPR 1253/500/10H
Spanning	V	3x400	3x400	3x400	3x400	3x400
Aangezogen lucht	l/min	650	850	850	950	1200
Smeersysteem		HOS	HOS	HOS	HOS	HOS
Afgegeven lucht	l/min	520	680	680	750	900
Maximum druk	bar	10	10	10	10	10
Vermogen motor	kW	4,0	5,5	5,5	5,5	7,5
Tankinhoud	l	270	300	500	500	500
Cilinders/Trappen		2/2	2/2	2/2	2/2	2/2
Toerental	tpm	950	1240	1240	960	1220
Geluidsniveau - LPA (1m) DINISO3744	dB(A)	83	83	83	82	82
Luchtdrukaansluiting	inch	3/4	3/4	3/4	3/4	3/4
Gewicht	kg	190,00	195,00	235,00	320,00	245,00
Afmetingen (l x b x h)	mm		1690 x 500 x 1150	2020 x 570 x 1300	2020 x 570 x 1400	2020 x 570 x 1340
Prijs	€	2.139,00	2.385,00	2.699,00	3.149,00	3.615,00



AIRPROFI 903/500/15H

13/15 BAR
4KW 5,5KW 7,5KW
300L 500L
PRO

Stationaire zuigercompressoren met werkdruk 15 bar, en druktank van 300 of 500 liter.

Kenmerken:

- Standaard geleverd op werkdruk 13 bar. Regelbaar tot 15 bar.
- Grote hoeveelheid druklucht direct beschikbaar.
- Kwalitatieve 2-cilinder compressorpomp voor intensief gebruik. Het lage toerental garandeert een rustige, trillingsvrije loop
- Optimale koeling door groot loopwiel en koelribben beperken condensvorming in de tank
- Lage warmteontwikkeling, lange levensduur.
- Gepantserde, flexibele drukleiding voorkomt afbreken van de leiding.
- Thermische motorbeveiliging tegen overbelasting. Aanlooptasting beperkt de stroompiek.
- Verzinkte ketel, ook vanbinnen, geeft de beste garantie tegen doorroesten.
- CONDOR drukschakelaar, manometer en overdrukventiel

Geleverd met:

- Trillingsdempers
- Driefasige kwaliteitsmotor 3x400V.
- Model 7,5kW geleverd met ster-driehoekschakelaar en bedrijfsrenteller
- Aansluitklaar geleverd.

Order nr.		712025753 ^M	712025853 ^M	712025955 ^M
Orig. nr.		AIRPROFI 703/300/15H	AIRPROFI 753/300/15H	AIRPROFI 903/500/15H
Spanning	V	3x400	3x400	3x400
Aangezogen lucht	l/min	575	750	1030
Smeersysteem		HOS	HOS	HOS
Afgegeven lucht	l/min	460	525	765
Maximum druk	bar	13 (15)	13 (15)	13 (15)
Vermogen motor	kW	4	5,5	7,5
Tankinhoud	l	300	300	500
Cilinders/Trappen		2/2	2/2	2/2
Toerental	tpm	850	785	1050
Geluidsniveau - lPA (1m) DINISO3744	dB(A)	83	82	82
Luchtdrukaansluiting	inch	3/4	3/4	3/4
Gewicht	kg	220,00	230,00	300,00
Afmetingen (l x b x h)	mm	1690 x 500 x 1150	1690 x 500 x 1190	2020 x 570 x 1340
Prijs	€	2.315,00	2.889,00	3.979,00



AIRPROFI 1283/500/10H

10 BAR

5,5KW

11 KW

500L

PRO

Stationaire 4-cilinder zuigercompressoren met druktank van 500 liter.

Kenmerken:

- Grote hoeveelheid druklucht direct beschikbaar.
- Kwalitatieve 4-cilinder compressorpomp voor intensief gebruik. Het lage toerental garandeert een rustige, trillingsvrije loop
- Optimale koeling door groot loopwiel en koelribben beperken condensvorming in de tank
- Leverbaar in 2 versies:
 1. Standaarduitvoering zonder koeldroger
 2. K-versie met koeldroger en condensaflaat. Droge druklucht verlengt de levensduur van air tools aanzienlijk.
- Lage warmteontwikkeling, lange levensduur.
- Gepantserde, flexibele drukleiding voorkomt afbreken van de leiding.
- Thermische motorbeveiliging tegen overbelasting. Aanlooptlasting beperkt de stroompiek.
- Verzinkte ketel, ook vanbinnen, geeft de beste garantie tegen doorroesten.
- CONDOR drukschakelaar, manometer en overdrukventiel

Geleverd met:

- Trillingsdempers
- Driefasige kwaliteitsmotor 3x400V.
- Geleverd met ster-driehoekschakelaar en bedrijfsurenteller
- Aansluitklaar geleverd.

Order nr.		712027055 ^M	712027065 ^M	7120270551 ^M	7120270651 ^M
Orig. nr.		AIRPR 1283/500/10H	AIRPR 1703/500/10H	AIRPR 1283/500/10H	AIRPR 1703/500/10H
Aangezogen lucht	l/min	1270	1660	1270	1660
Smeersysteem		HOS	HOS	HOS	HOS
Afgegeven lucht	l/min	914	1195	914	1195
Maximum druk	bar	10	10	10	10
Vermogen motor	kW	7,5	11	7,5	11
Tankinhoud	l	500	500	500	500
Cilinders/Trappen		4/2	4/2	4/2	4/2
Toerental	tpm	870	1140	870	1140
Geluidsniveau - LPA (1m) DINISO3744	dB(A)	86	86	86	86
Luchtdrukaansluiting	inch	3/4	3/4	3/4	3/4
Type koeldroger					
Gewicht	kg	320,00	325,00	320,00	325,00
Afmetingen (l x b x h)	mm	2020 x 570 x 1400	2020 x 570 x 1400	2020 x 570 x 1400	2020 x 570 x 1400
Prijs	€	5.610,00	6.190,00	5.610,00	6.190,00



AIRPROFI 903/500/15H



Stationaire zuigercompressoren met werkdruk 15 bar, en druktank van 300 of 500 liter.

Kenmerken:

- Standaard geleverd op werkdruk 13 bar. Regelbaar tot 15 bar.
- Grote hoeveelheid druklucht direct beschikbaar.
- Kwalitatieve 2-cilinder compressorpomp voor intensief gebruik. Het lage toerental garandeert een rustige, trillingsvrije loop
- Optimale koeling door groot loopwiel en koelribben beperken condensvorming in de tank
- Lage warmteontwikkeling, lange levensduur.
- Gepantserde, flexibele drukleiding voorkomt afbreken van de leiding.
- Thermische motorbeveiliging tegen overbelasting. Aanlooptasting beperkt de stroompiek.
- Verzinkte ketel, ook vanbinnen, geeft de beste garantie tegen doorroesten.
- CONDOR drukschakelaar, manometer en overdrukventiel

Geleverd met:

- Trillingsdempers
- Driefasige kwaliteitsmotor 3x400V.
- Model 7,5kW geleverd met ster-driehoekschakelaar en bedrijfsrenteller
- Aansluitklaar geleverd.

Order nr.		712025753 ^M	712025853 ^M	712025955 ^M
Orig. nr.		AIRPROFI 703/300/15H	AIRPROFI 753/300/15H	AIRPROFI 903/500/15H
Spanning	V	3x400	3x400	3x400
Aangezogen lucht	l/min	575	750	1030
Smeersysteem		HOS	HOS	HOS
Afgegeven lucht	l/min	460	525	765
Maximum druk	bar	13 (15)	13 (15)	13 (15)
Vermogen motor	kW	4	5,5	7,5
Tankinhoud	l	300	300	500
Cilinders/Trappen		2/2	2/2	2/2
Toerental	tpm	850	785	1050
Geluidsniveau - lPA (1m) DINISO3744	dB(A)	83	82	82
Luchtdrukaansluiting	inch	3/4	3/4	3/4
Gewicht	kg	220,00	230,00	300,00
Afmetingen (l x b x h)	mm	1690 x 500 x 1150	1690 x 500 x 1190	2020 x 570 x 1340
Prijs	€	2.315,00	2.889,00	3.979,00

aircraft



AIRPROFI 853/270/10 V

10 BAR
4KW 5,5KW 7,5KW
270L
PRO



Condensafleider Bekomat 31 (712049049)



WE AC 1/4"

Stationaire zuigercompressoren met staande druktank van 270 liter

Kenmerken:

- Plaatsbesparende verticale ketel van 270 liter. Perfect voor kleine compressorlokalen.
- Kwalitatieve compressorpomp voor intensief gebruik. Het lage toerental garandeert een rustige, trillingsvrije loop
- Optimale koeling door groot loopwiel en koelribben beperken condensvorming in de tank
- Lage warmteontwikkeling, lange levensduur.
- Gepantserde, flexibele drukleiding voorkomt afbreken van de leiding.
- Thermische motorbeveiliging tegen overbelasting. Aanlooptlastering beperkt de stroompiek.
- 3 aftap- of aansluitpunten op de ketel.
- Verzinkte ketel, ook vanbinnen, geeft de beste garantie tegen doorroesten.
- CONDOR drukschakelaar, manometer en overdrukventiel

Geleverd met:

- Trillingsdempers
- Driefasige kwaliteitsmotor 3x400V. Model 7,5kW geleverd met ster-driehoekschakelaar
- Aansluitklaar geleverd.

Order nr.		712024712 M	712024812 M	712024912 M	712025012 M
Orig. nr.		AIRPROFI 703/270/10V	AIRPROFI 853/270/10V	AIRPR 1003/270/10V	AIRPR 1253/270/10V
Spanning	V	3x400	3x400	3x400	3x400
Aangezogen lucht	l/min	650	850	960	1200
Smeersysteem		HOS	HOS	HOS	HOS
Afgegeven lucht	l/min	520	680	750	900
Maximum druk	bar	10	10	10	10
Vermogen motor	kW	4	5,5	5,5	7,5
Tankinhoud	l	270	270	270	270
Cilinders/Trappen		2/2	2/2	2/2	2/2
Toerental	tpm	950	1240	1060	1220
Geluidsniveau - LPA (1m) DINISO3744	dB(A)	83	83	82	82
Luchtdrukaansluiting	inch	3/4	3/4	3/4	3/4
Gewicht	kg	160,00	170,00	160,00	160,00
Afmetingen (l x b x h)	mm	780 x 710 x 1870	780 x 710 x 1870	850 x 710 x 1950	850 x 710 x 1950
Prijs	€	2.239,00	2.459,00	2.775,00	3.499,00



AIRPROFI 853/270/10 V

13/15 BAR

4KW 5,5KW

270L

PRO

Stationaire zuigercompressoren met werkdruk 15 bar en staande druktank van 270 liter.

Kenmerken:

- Standaard geleverd op werkdruk 13 bar. Regelbaar tot 15 bar.
- Plaatsbesparende verticale ketel van 270 liter. Perfect voor kleine compressorlokalen.
- Kwalitatieve compressorpomp voor intensief gebruik. Het lage toerental garandeert een rustige, trillingsvrije loop
- Optimale koeling door groot loopwiel en koelribben beperken condensvorming in de tank
- Lage warmteontwikkeling, lange levensduur.
- Gepantserde, flexibele drukleiding voorkomt afbreken van de leiding.
- Thermische motorbeveiliging tegen overbelasting. Aanloopontlasting beperkt de stroompiek.
- 3 aftap- of aansluitpunten op de ketel.
- Verzinkte ketel, ook vanbinnen, geeft de beste garantie tegen doorroesten.
- CONDOR drukschakelaar, manometer en overdrukventiel

Geleverd met:

- Trillingsdempers
- Driefasige kwaliteitsmotor 3x400V. Model 7,5kW geleverd met ster-driehoekschakelaar
- Aansluitklaar geleverd.

Order nr.		712024752	712024852
Orig. nr.		AIRPROFI 703/270/15V	AIRPROFI 753/270/15V
Spanning	V	3x400	3x400
Aangezogen lucht	l/min	575	750
Smeersysteem		HOS	HOS
Afgegeven lucht	l/min	460	525
Maximum druk	bar	13 (15)	13 (15)
Vermogen motor	kW	4	5,5
Tankinhoud	l	270	270
Cilinders/Trappen		2/2	2/2
Toerental	tpm	850	785
Geluidsniveau - LPA (1m) DINISO3744	dB(A)	83	82
Luchtdrukaansluiting	inch	3/4	3/4
Gewicht	kg	190,00	190,00
Afmetingen (l x b x h)	mm	745 x 652 x 1860	850 x 710 x 1950
Prijs	€	2.459,00	2.985,00

Schroefaangedreven



A-MICRO



A-MICRO-D



A-MICRO DK

10 BAR

1KW

200L

300L

PRO

Geluidsarme 61 db(A) schroefcompressoren 10 bar met of zonder tank 200 of 300L en met of zonder koeldroger voor kleinere drukluchtbehoefte.

Troeven:

- Plaats- en energiebesparende schroefcompressoren met hoogwaardige riemaandrijving.
- Continu luchtverbruik mogelijk tegen lage aanschaf- en bedrijfskosten. Kan perfect dienen als hoofdcompressor in bestaande of nieuwe netwerken.
- Superisolerende omkasting reduceert het geluidsniveau drastisch tot 61dB(A). Draait zonder overlast in een werkplaats.
- Aan/uitschakeling met drukknop, geen kosten door leegloop, of door aanschaf van een sturing
- Intensieve koeling beperkt condensatie in de ketel en het netwerk
- Ingebouwde veiligheids: thermische motorbeveiliging, bewaking olietemperatuur, bedrijfsurenteller, trillingsdempers.
- Driefasige kwaliteitsmotor 3x400V.
- Gebruiksvriendelijke toegang tot alle onderhoudselementen.

Leverbaar in 3 versies:

- Type A-MICRO : Tankloze compressor
- Type A-MICRO-D : Compressor met 200 of 300l druktank, Verzinkte ketel, ook vanbinnen, geeft de beste garantie tegen doorroesten: 15 jaar
- Type A-MICRO-DK: Compressor met 200 of 300l druktank en koeldroger

Ook modellen beschikbaar in 8 bar/ debiet 580l/min.

Optionele trolley voor tankloze compressor.

Order nr.		712089001 ^(H)	712089003 ^(H)	712081664 ^(H)
Orig. nr.		A-MICRO 4-10	A-MICRO D 4-10-300	2081664
Type		A-MICRO	A-MICRO-D	A-MICRO-DK
Spanning	V	3x400	3x400	3x400
Afgegeven lucht	l/min	485	485	485
Maximum druk	bar	10	10	10
Vermogen motor	kW	4	4	4
Tankinhoud	l		300	200
Geluidsniveau - LPA (1m) DINISO3744	dB(A)	61	61	61
Luchtdrukaansluiting	inch	1/2	1/2	1/2
Gewicht	kg	93,00	93,00	182,00
Afmetingen (l x b x h)	mm	580 x 480 x 760	1745 x 600 x 1460	
Prijs	€	3.295,00	4.349,00	4.789,00

OPROPHASPELS

p. 414



A-KMID 5.5.10

10 BAR
5,5KW **7,5KW**
300L
PRO



A-MKID-D 5.5-10



A-KMID-DK 5.5.10

Geluidsarme, (< 63 db(A)) coaxiale schroefcompressoren 10 bar met of zonder tank en met of zonder droger voor continu bedrijf

Troeven:

- Directgekoppelde coaxiale schroefcompressoren met zeer beperkte onderhoudsbehoefte en zeer hoge belastbaarheid tot 100%.
- Energiebesparend door uiterst efficiënte overdracht van het volle motorvermogen.
- Standaard met ster-driehoekschakelaar en elektronische sturing EasyTRONIC II met druksensorbediening, voor een optimale motorbelasting en lange levensduur. Alle belangrijke functies worden gemonitord op het digitale display.
- Superisolerende omkasting en thermostatisch gestuurde ventilator reduceren het geluidsniveau drastisch tot 62dB(A). Draait zonder overlast in een werkplaats.
- Voorzien van verschillende ingebouwde veiligheden:
- Thermische motorbeveiliging en bedrijfsurenteller met registratie van last- en leeglooptijden. Automatische melding voor onderhoud.
- Draairichtingscontrole op de motor, voorkomt schade bij inbedrijfstelling, verplaatsing of bij faseverwisseling.
- Grote warmtewisselaar voor optimale oliekoeling. alle olieleidingen uit flexibele, gepantserde slangen.
- Koelcircuit beperkt condensatie in de tank en het netwerk
- Gebruiksvriendelijke toegang tot alle onderhoudselementen.

Leverbaar in 3 versies:

- Type A-KMID : Tankloze compressor
- Type A-KMID-D : Compressor met 300l druktank met verzinkte tank, ook vanbinnen, geeft de beste garantie tegen doorroesten: 15 jaar.
- Type A-KMID-DK : Compressor met 300l druktank en koeldroger

Ook modellen beschikbaar met werkdruk 13 bar.

Order nr.		712089100	712089102	712089104	712089106	712089108
Orig. nr.		A-KMID 5.5-10	A-KMID 7.5-10	A-KMID-D 5.5-10	A-KMID-D 7.5-10	A-KMID-DK 5.5-10
Type		A-KMID	A-KMID	A-KMID-D	A-KMID-D	A-KMID-DK
Spanning	V	3x400	3x400	3x400	3x400	3x400
Afgegeven lucht	l/min	705	1050	705	1050	705
Maximum druk	bar	10	10	10	10	10
Vermogen motor	kW	5.5	7.5	5.5	7.5	5.5
Tankinhoud	l	-	-	300	300	300
Geluidsniveau - LPA (1m) DINISO3744	dB(A)	62	62	62	62	62
Luchtdrukaansluiting	inch	1/2	1/2	1/2	1/2	1/2
Gewicht	kg	160,00	165,00	255,00	260,00	290,00
Afmetingen (l x b x h)	mm	720 x 650 x 860	720 x 650 x 860	1745 x 650 x 1560	1745 x 650 x 1560	1745 x 650 x 1560
Prijs	€	4.469,00	4.595,00	5.570,00	5.690,00	7.100,00



10 BAR

11KW

15KW

500L

PRO



A-QUADRO-DK 11-10



A-QUADRO 11-10



Geluidsarme, riemaangedreven schroefcompressoren 10 bar met of zonder tank en met of zonder droger voor continubedrijf.

Troeven:

- Hoogwaardige riemaandrijving voor optimale krachtoverbrenging en hoge belastbaarheid tot 100%.
- Compact gebouwd en mobiel, en toch een heel groot luchtdebiet.
- Standaard met ster-driehoekschakelaar en elektronische sturing EasyTRONIC II met druksensorbediening, voor een optimale motorbelasting en lange levensduur. Alle belangrijke functies worden gemonitord op het digitale display.
- Superisolerende omkasting en thermostatisch gestuurde ventilator reduceren het geluidsniveau drastisch tot 62dB(A). Draait zonder overlast in een werkplaats.
- Voorzien van verschillende ingebouwde veiligheden:
- Temperatuurbewaking op de schoefunit.
- Thermische motorbeveiliging en bedrijfsurenteller met registratie van last- en leeglooptijden. Automatische melding voor onderhoud.
- Draairichtingscontrole op de motor, voorkomt schade bij inbedrijfstelling, verplaatsing of bij faseverwisseling.
- Grote warmtewisselaar voor optimale drukluchtcooling en oliekoeling. alle leidingen met hoge temperatuurbestendigheid.
- Koelcircuit beperkt condensatie in de tank en het netwerk.
- Gebruiksvriendelijke toegang tot alle onderhoudselementen.

Leverbaar in 3 versies:

- Type A-QUADRO : Tankloze compressor
- Type A-QUADRO-D : Compressor met 500l druktank met verzinkte tank, ook vanbinnen, geeft de beste garantie tegen doorroesten.
- Type A-QUADRO-DK : Compressor met 500l druktank en koeldroger

Ook modellen beschikbaar met werkdruk 8 en 13 bar.

Order nr.	712089131	712089133	712089136	712089138	712089141	712089143
Orig. nr.	A-QUADRO 11-10	A-QUADRO 15-10	A-QUADRO-D 11-10	A-QUADRO-D 15-10	A-QUADRO-DK 11-10	A-QUADRO-DK 15-10
Type	A-QUADRO	A-QUADRO	A-QUADRO	A-QUADRO	A-QUADRO-DK	A-QUADRO-DK
Spanning	V 3x400	3x400	3x400	3x400	3x400	3x400
Afgegeven lucht	l/min 1500	1850	1500	1850	1500	1850
Maximum druk	bar 10	10	10	10	10	10
Vermogen motor	kW 11	15	11	15	11	15
Tankinhoud	l		500	500	500	500
Geluidsniveau - LPA (1m) DINISO3744	dB(A) 69	70	69	70	69	70
Luchtdrukaansluiting	inch 3/4	3/4		3/4	3/4	3/4
Gewicht	kg 230,00	250,00	380,00	400,00	422,00	442,00
Afmetingen (l x b x h)	mm 800 x 650 x 980	800 x 650 x 980	1980 x 650 x 1630	1980 x 650 x 1630	1980 x 650 x 1630	1980 x 650 x 1630
Prijs	€ 5.380,00	5.420,00	6.580,00	6.770,00	7.910,00	8.470,00

LUCHTDRIUK-VERDEELSYSTEMEN

De AIRCRAFT luchtdruk-verdeelsystemen zijn kosten besparend en op maat gemaakt. VYNCKIER stelt graag samen met u een maatoplossing voor.

- Kunststof en Alu leidingen Ø15 tot 28mm
- Voor kleine werkplaatsen tot fabrieksgebouwen
- Eenvoudige montage met snelkoppelingen
- Onderhoudsarm
- Kostenbesparend

Het AIRCRAFT drukluchtsysteem biedt de volgende voordelen:

- Gladde kunststof wand, met perfecte luchtgeleiding
- Snelle en eenvoudige installatie met snelkoppelingen, zonder gereedschap
- 50% tijdsbesparing op de montagetijd
- Geen extra dichtingen of materialen nodig
- De koppelingen zijn veelvoudig opnieuw bruikbaar
- Toepasbaar met allerlei metalen of kunststof buizen
- Flexibel aanpasbare aftakdozen
- Onderhoudsvrij systeem
- U bespaart op onderhoudskosten, installatiekosten en bedrijfskosten

Ons AIRCRAFT Airtools assortiment ziet u hieronder.



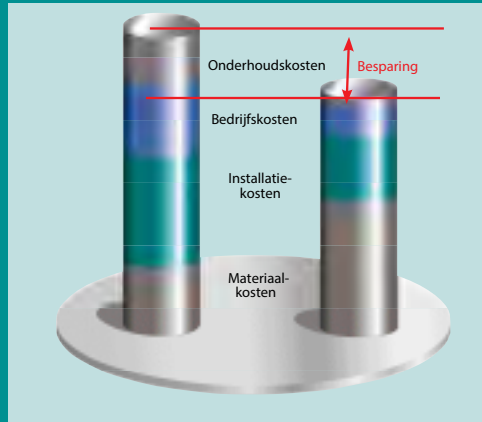

SNELKOPPELINGEN: SNELLE INSTALLATIE DOOR HET EENVOUDIG INEENSCHUIVEN :

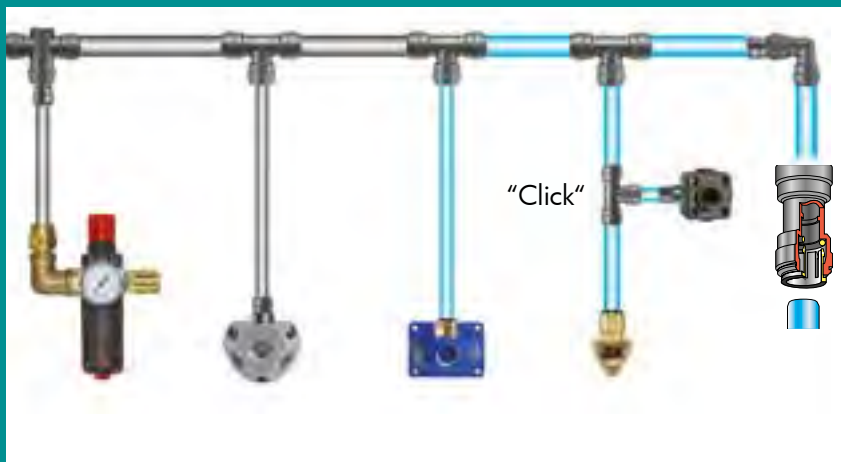
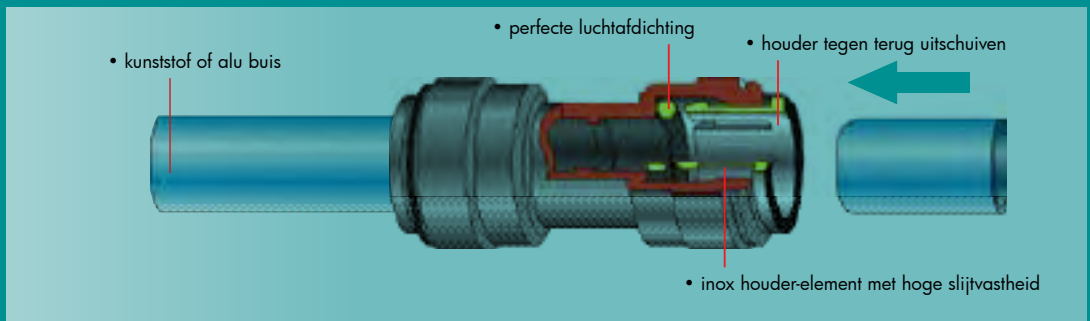

Luchtbehandeling



Vervangglas voor filterdrukregelaar.

Order nr.	Orig. nr.	Omschrijving	Prijs €
712316001	2316001	voor FDR AC 1/4" (712316000)	19,50
712316201	2316201	voor FDR AC 1/2" (712316200)	25,50
712316061	2316061	voor NO AC 1/4" (712316060)	19,50
712316261	2316261	voor NO AC 1/2" (712316260)	26,90



Waterafscheider. 12 bar.

Order nr.	712316070	712316270	712316370
Orig. nr.	2316070	2316270	2316370
Draadaansluiting	1/4"	1/2"	1"
Werkdruk	bar 12	12	12
Prijs	€ 0,00	43,90	98,90



Olievernevelaar.

Order nr.	712316060	712316260	712316360
Orig. nr.	2316060	2316260	2316360
Draadaansluiting	1/4"	1/2"	1"
Werkdruk	bar 12	12	12
Prijs	€ 34,90	0,00	94,50



Air control Unit. Bestaat uit filterdrukregelaar en olievernevelaar. 12 bar.

Order nr.	712316080	712316280
Orig. nr.	2316080	2316280
Draadaansluiting	1/4"	1/2"
Werkdruk	bar 12	12
Prijs	€ 85,50	111,00



712502104



712502104



AIRPROFI 853/100/10H



712502102

Vergroot je drukluchtcapaciteit met 150 tot 400 liter extra, door middel van een tankbatterij op maat.

Ideaal om bestaande compressoren met kleine tankcapaciteit uit te breiden. Lost het probleem van een krap compressorlokaal op, de tankbatterij kan op afstand van de compressor geplaatst worden.

Tankbatterij KB 2x100/10

- 2x 100L druktank 10 bar
- Extra capaciteit op uw bestaande installatie
- De grotere drukluchtvoorraad kan piekbehoeftes opvangen.
- Elke tank is voorzien van een afsluitkraan en manometer, om indien nodig een snellere drukopbouw te bekomen
- Plaatsbesparend door verticale opstelling: het grootste volume op de kleinste oppervlakte

Tankbatterij KB 2x75/13

- 2x 75L druktank 13 bar
- Extra capaciteit op uw bestaande installatie
- De grotere drukluchtvoorraad kan piekbehoeftes opvangen.
- Elke tank is voorzien van een afsluitkraan en manometer, om indien nodig een snellere drukopbouw te bekomen
- Plaatsbesparend door verticale opstelling: het grootste volume op de kleinste oppervlakte

Tankbatterij KB 4x100/10

- 4x 100L druktank 10 bar
- Extra capaciteit op uw bestaande installatie
- De grotere drukluchtvoorraad kan piekbehoeftes opvangen.
- Elke tank is voorzien van een afsluitkraan en manometer, om indien nodig een snellere drukopbouw te bekomen
- Plaatsbesparend door verticale opstelling: het grootste volume op de kleinste oppervlakte

Order nr.	712502102	712502104	712502132
Maximum druk	bar 10	10	13
Omschrijving	l 2x100	4x100	2x75
Prijs	€ 1.295,00	2.135,00	1.515,00

aircraft



Filterdrukregelaar. 12 bar.

Order nr.	712316000 ^M	712316200 ^M	712316300 ^M
Orig. nr.	2316000	2316200	2316300
Draadaansluiting	1/4"	1/2"	1"
Werkdruk bar	12	12	12
Prijs	€ 48,90	56,50	134,00

IME



Mini olievernelaar 1/4". Speciaal voor Race luchtdruktoestellen. Alle luchtdruktoestellen moeten voldoende voorzien zijn van olie teneinde slijtage en roest te voorkomen.

Order nr.	205710106 ^M
Orig. nr.	205710106
Prijs	€ 12,50

aircraft



Automatische condensaflaten type AOK.

Niveaigestuurde, automatische aflaats van condens of andere niet-agressieve vloeistoffen

Order nr.	712053072 ^M	712053074 ^M
Orig. nr.	AOK 16B	AOK 20B
Afscheidingscapaciteit	l/u	167
Werkdruk	min/ max bar	16 20
Temperatuur minimum/ maximum	°C	1,6 - 65 1,5 - 65
Condensaervoer	G 1/2"	G 1/2"
Condensaafvoer	8 mm	G 1/2"
Prijs	€ 36,90	62,50

aircraft



Olie voor drukluchtgereedschap. Beschermt tegen corrosie en smeert bewegende delen. Goede viscositeit in lage temperatuur.

Order nr.	712500011 ^M
Orig. nr.	2500011
Inhoud	l
Prijs	€ 15,50

aircraft



Dielektrische vloeistof IME 110 ICO P50 voor Airboy Silence.

Order nr.	712500014 ^M
Orig. nr.	2500014
Inhoud	l
Prijs	€ 16,90

MACHINES VOOR

Holzkräft kwaliteitsmachines voor houtbewerking

De wensen van onze klanten en de ervaring die is opgedaan gedurende decennia hebben altijd de basis gevormd van onze moderne, veilige en vooral efficiënte machines. De Holzkräft HWS 700 werd benoemd tot beste in de praktijktesten boven andere machines. HOLZKRAFT machines voor houtbewerking worden gebruikt door professionals in de land- en bosbouw, alsook door particuliere gebruikers. HOLZKRAFT machines betekenen kwaliteit, betrouwbaarheid, veiligheid en duurzaamheid.

We bieden deze machines aan:

- Houtsplitters
- Zaagmachines
- Boormachines
- Combinatiemachines
- ...

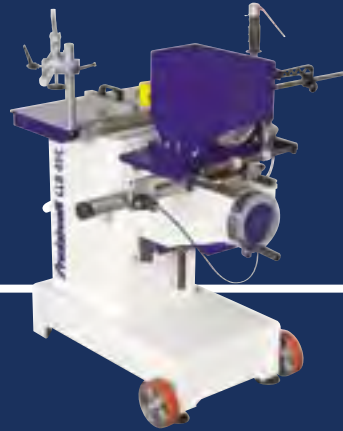

HOUTBEWERKING

Holzstar Houtbewerkingsmachines voor veeleisende beginners

HOLZSTAR biedt een houtbewerkingsprogramma aan voor beginners voor verschillende toepassingsgebieden zoals de modelbouw, binnenhuisinrichtingen, bouwplaatsen, productie van speelgoed, enz. Perfect voor beginners in de houtbewerking!

We leveren deze houtbewerkingsmachines:

- Rollerbanen
- Decoupeerzagen
- Bandzagen
- Cirkelzagen
- Draaibanken
- Slijpmachines
- Stofzuigers en spaanderzuigers
- Accessoires

...



 **holzstar**
Holzbearbeitungsmaschinen

Slijpmachines

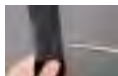

Beoordeling en vaststelling van de snijhoek

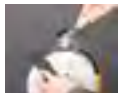

Instellen van de geschikte beugelhoogte voor de snijhoek



Instellen van de gemeten snijhoek

Universeel instelbare nat en droogslijpmachine

Troeven:

- voor het slijpen van metalen, glas, steen en andere materialen
- Ideaal voor de hobbist en handwerker
- Draagbaar.
- Voor zowel nat als droog slijpen.
- In de hoogte verstelbare houderbeugel dia. 12mm, kunnen ook houders van andere leveranciers in gebruik worden.
- Speciaal ontwikkelde waterbestendige slijpsteen voor langere standtijd
- Voorzien van een waterbakje.
- Dankzij het geringe toerental van 90 rpm/min in combinatie met het water kan geslepen worden zonder hitte.
- Aan/uit schakelaar met noodstop.

Standaard geleverd met:

- Witte slijpsteen
- Lederen Wetschijf
- Universele houder
- Hoekmeter
- Opbergvak.

Tip: Optionele houders laten toe om gemakkelijk alle soorten messen, beitels, bijlen, etc. te slijpen.

Order nr.		715902251 ^M
Orig. nr.		NTS251
Spanning	V	230
Vermogen motor	W	200
Afmetingen slijpsteen (diameter x b)	mm	250x50
Afmetingen lederen schijf (diameter x b)	mm	220x30
Toerental	tpm	90
Gewicht	kg	20,00
Afmetingen (l x b x h)	mm	340 x 280 x 460
Prijs	€	229,00



Slijpen van messen
713800027



Uitlijnen van slijpsteen
713800029



Slijpen van freesmessen
713800024



Hulpstuk voor accessoires
713800026



Vorbereiden slijpsteen (grof/fijn)
713800030



Slijpen van bijlen
713800018



Slijpen onder hoek van 0-30°
713800038



Slijpen van rondbeitels
713800021

Accessoires voor NTS251.

Order nr.	Omschrijving	Prijs €
713800027 ^M	voor messen	53,50
713800029 ^M	voor uitlijnen van slijpsteen	71,50
713800024 ^M	voor freesmessen	66,90
713800026 ^M	hulpstuk voor accessoires	44,50
713800030 ^M	vorbereiden slijpsteen	30,50
713800018 ^M	voor slijpen van bijlen	34,90
713800038 ^M	voor slijpen onder hoek 0-30°	32,50
713800021 ^M	ronde houtbeitels	59,50

Schuur- & schaafmachines

holzstar



0°
45°

• Hoekaanslag

BTS150

1000W

• Grote alu werktafel

1000W

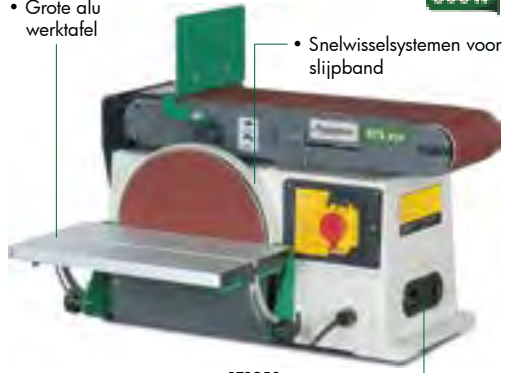

• Snelwisselsystemen voor slijpband

BTS250

• Transporthendels

Universele band- en schijfschuurmachine. Voor ontbramen, afvlakken, en slijpen.

Troeven:

- Snelspanner voor een eenvoudige en snelle schuurband wissel.
- Geïntegreerde aansluiting voor stofzuiger.
- Torsievrije machinebehuizing uit gietijzer
- Traploos onder hoek vestelbare slijpband van 0° tot 90° (BTS150)
- De slijpband Kan zowel horizontaal als verticaal gebruikt worden
- Beschikt over een dubbele geleiding van de schuurtafel voor een verbeterde stabiliteit.
- Schuurtafel is onder hoek verstelbaar van 0° tot 45°.

Geschikt voor:

- het bewerken van harde en zachte houtsoorten
- het produceren van allerlei vormen: lange zijden, vlakken, hoeken, vlakke oppervlakten en rechte hoeken.
- Modelbouwers en de veeleisende doe-het-zelver



0 - 90°
enkel bij BTS150

Standaard geleverd met:

- 1 schuurband en schuurshijf
- Hoekaanslag (BTS150)
- Grote Aluminium werktafel (BTS250)
- Praktische transporthendels (BTS250)
- Nederlandstalige handleiding

Order nr.	715904150 ^M	715904250 ^M
Orig. nr.	BTS150	BTS250
Spanning	V 230	230
Afmetingen tafel (b x d)	mm 150x230	360x200
Toerental	tpm 2850	1440
Vermogen motor	kW 0,4	0,8
Afzuiging diameter	mm 58	58
Afmetingen schuurband	mm 915x100	1220x150
Diameter schuurshijf	mm 150	250
Gewicht	kg 18,00	50,00
Afmetingen (l x b x h)	mm 560 x 270 x 300	720 x 410 x 440
Prijs	€ 200,00	535,00

holzstar



Machievoet voor BTS 250

Order nr.	715914250 ^M
Prijs	€ 71,90

holzstar



Scheidingsplaat voor Holzstar schuurmachines BTS 150, 200 en 250.

Order nr.	715900301 ^M
Omschrijving	scheidingsplaat voor schuurshijven
Voor type	Universeel
Prijs	€ 27,50



• 150 x 1219 mm

• 2 alu werktafels

• Inclusief onderstel



1,1KW

ACCESSOIRES

p. 1166

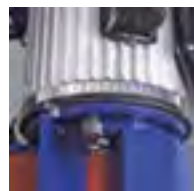

Universele band- en schijfschuurmachine. Voor ontbramen, afvlakken, en slijpen.

Troeven:

- Snelspanner voor een eenvoudige en snelle schuurband wissel.
- Geïntegreerde aansluiting voor stofzuiger.
- Torsievrije machinebehuizing uit gietijzer
- Traploos onder hoek verstelbare slijpband van 0° tot 90°
- De slijpband kan zowel horizontaal als verticaal gebruikt worden
- Beschikt over een dubbele geleiding van de schuurtafel voor een verbeterde stabiliteit.
- Schuurtafel is onder hoek verstelbaar van -15° tot +45°.

Geschikt voor:

- het bewerken van harde en zachte houtsoorten
- het produceren van allerlei vormen: lange zijden, vlakken, hoeken, vlakke oppervlakten en rechte hoeken.
- Modelbouwers en de veeleisende doe-het-zelver

Standaard geleverd met:

- 1 schuurband K100 en schuurshijf K80
- Hoekaanslag
- 2 Aluminium werktafels voor band en schijf.
- Machine onderstel
- Nederlandstalige handleiding

Order nr.

715902200

Orig. nr.		BTS200
Spanning	V	230
Vermogen motor	kW	1,1
Afmetingen schuurband	mm	152x1219
Diameter schuurshijf	mm	305
Snelheid	m/s	12
Gietijzeren werktafel	mm	315x155
Aluminium werktafel	mm	400x225
Hoek werktafel	°	-15 - +45
Afzuiging	mm	2 x 63
Hoek band	°	0-90
Gewicht	kg	53,00
Afmetingen (l x b x h)	mm	830 x 620 x 1340
Prijs	€	665,00



ACCESSOIRES
p. 1166



Bandschuurmachine met verstelbare schuurunit en 2 stabiele tafels.

Troeven:

- Tafel traploos in lengte en hoek instelbaar van 0° tot 45°.
- Horizontaal en verticaal inzetbaar, wat enorm veel toepassingsmogelijkheden toelaat
- Verticaal schuren is mogelijk
- Snel wisselen van slijpband door snelklemmingsstelsel
- Contourschuren op de dwarstafel
- De langs werktafel is in de hoogte verstelbaar met 80 mm voor optimaal gebruik van de slijpbandbreedte
- Verstelbare hoekaanslag
- Krachtige en stille motor
- Grafiet afdekking onder de schuurband voor een betere geleiding en een langere levensduur

Geschiedt voor:

- het schuren van lange stukken, zowel horizontaal als verticaal
- het afschuiven onder een bepaalde hoek
- het schuren van verschillende radii
- Veeleisende doe-het-zelver

Geleverd met:

- 1 schuurband
- 2 degelijke Aluminium werktafels
- Stabiël onderstel
- Verstelbare hoekaanslag
- Nederlandstalige handleiding

Order nr.		715900791 [Ⓜ]	715900790 [Ⓜ]
Orig. nr.		KSO790 230V	KSO790 400V
Spanning	V	1x230	3x400
Werkhoogte minimum/maximum	mm	810/890	810/890
Vermogen motor	kW	1,5	1,5
Afmetingen schuurband	mm	2010x152	2010x152
Hoek werktafel	°	0 - 45	0 - 45
Afmetingen lange tafel	mm	790x221	790x221
Afmetingen tafel zijkant	mm	514x221	514x221
Schuurbandsnelheid	m/s	11	11
Diameter rondschuren	mm	70	70
Diameter zuigmond	mm	100	100
Tafelhoogte verstelbaar	mm	80	80
Diameter wals	mm	70	70
Slijpbreedte	mm	790x152	790x152
Gewicht	kg	86,00	86,00
Afmetingen (l x b x h)	mm	1300 x 600 x 1050	1300 x 600 x 1050
Prijs	€	789,00	795,00

MACHINES



ACCESSOIRES
p. 1166

Bandschuurmachine met verstelbare slijpunit en oscillerende slijpband

Troeven:

- Met oscillerende slijpband om ideaal materiaal te verwijderen, een mooie finish te bekomen en verbeterd aanzienlijk de levensduur van de slijpband
- Werktafel met hoogteverstelling via handwiel
- Met een hoek- en werkstukaanslag variabel instelbaar van -45° tot +45°
- Hoekverstelling van de band (0° tot 90°) voor verticale en horizontale toepassingen
- Robuuste werktafel van gietijzer met T-gleuven, verzekert een stabielere werking gedurende uw slijpbewerkingen
- Met bijkomende in de hoogte verstelbare extra zijtafel voor contourslijpen
- Snel en gemakkelijk vervangen van de band
- Geveerde kleminrichting garandeert een uniforme bandspanning
- Met grafietband voor een hogere levensduur van de slijpband
- Met afsluitbaar onderstel
- Krachtige, stille motor

Geschikt voor:

- het schuren van lange stukken, zowel horizontaal als verticaal
- het afschuiven onder een bepaalde hoek
- het schuren van verschillende radii
- Veeleisende doe-het-zelver, reparateurs, ontwerpers

Geleverd met:

- 1 schuurband
- 2 gietijzeren werktafels
- Verstelbare hoekaanslag
- Werkstukaanslag
- Afsluitbaar onderstel met opbergruimte
- Nederlandstalige handleiding

Order nr.		715900851	715900850
Orig. nr.		KSO850 230V	KSO850 400V
Spanning	V	1x230	3x400
Werkhoogte minimum/maximum	mm	950/1030	950/1030
Vermogen motor	kW	2,2	2,2
Afmetingen schuurband	mm	2515x152	2515x152
Hoek werktafel	°	-45 / +45	-45 / +45
Hoek band	°	0 - 90	0 - 90
Afmetingen lange tafel	mm	840x300	840x300
Afmetingen tafel zijkant	mm	300x250	300x250
Schuurbandsnelheid	m/s	16	16
Diameter rondschuren	mm	110	110
Diameter zuigmond	mm	100	100
Tafelhoogte verstelbaar	mm	80	80
Werkstuk aanslag	mm	700x60	700x60
Slijpbreedte	mm	950x180	950x180
Gewicht	kg	148,00	148,00
Afmetingen (l x b x h)	mm		1430 x 600 x 1250
Prijs	€	1.299,00	1.259,00

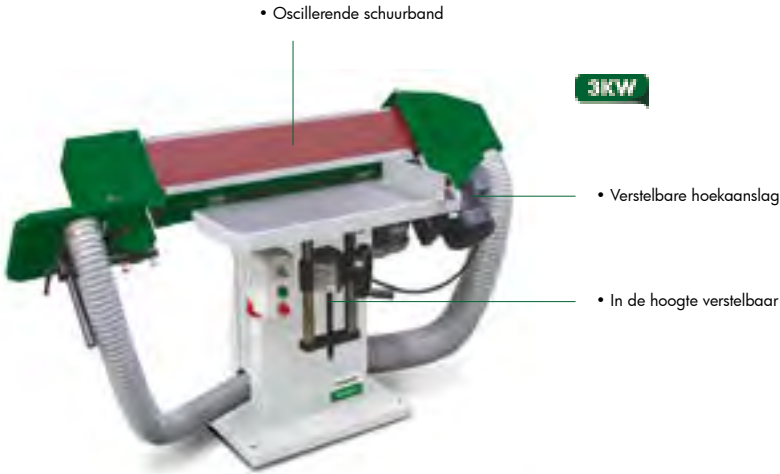

• Oscillerende schuurband

3kW

• Verstelbare hoekaanslag

• In de hoogte verstelbaar

Oscillerende bandschuurmachine met krachtige aandrijfmotor voor optimale schuurresultaten.

Troeven:

- De gelaste plaatstalen constructie garandeert een hoog niveau van torsiestijfheid en een trillingsvrije verwerking
- Schuurband traploos instelbaar onder hoek 0°-45° door middel van een hendel voor het schuren van rechte en afgeschuinde randen
- Oscillerende schuurband **met afzonderlijke tandwielmotor van 0.25 kW** voor optimale schuurresultaten. Oscillatie kan zo als extra hulp worden geactiveerd.
- Langere standtijd van de slijpband dankzij grafietband.
- Zware gietijzeren hoofdtafel instelbaar in hoogte voor het optimaal benutten van het ganse bandoppervlak.
- Zijtafel voor het slijpen van verschillende radii, ook instelbaar in hoogte.
- Automatische, geveerde schuurbandspanning.
- Verstelbare hoekaanslag
- Aparte noodstop en aparte startknop
- Krachtige en stille motor

Geschikt voor:

- het schuren van lange stukken, zowel horizontaal als verticaal
- het afschuinen onder een bepaalde hoek
- het schuren van verschillende radii
- Veeleisende doe-het-zelver, reparateurs, ontwerpers, semi-professionals

Geleverd met:

- 1 schuurband
- 2 gietijzeren werktafels
- Verstelbare hoekaanslag
- Werkstukaanslag
- Nederlandstalige handleiding

Order nr.	715901500	
Orig. nr.	KSO1500F	
Spanning	V	3x400
Werkhoogte minimum/maximum	mm	740/920
Vermogen motor	kW	3,0
Afmetingen schuurband	mm	2600x150
Afmetingen lange tafel	mm	750x300
Afmetingen tafel zijkant	mm	330x330
Schuurbandsnelheid	m/s	20
Diameter rondschuren	mm	100
Diameter zuigmond	mm	120/80
Tafelhoogte verstelbaar	mm	180
Slijpbreedte	mm	850x200
Gewicht	kg	180,00
Afmetingen (l x b x h)	mm	1430 x 600 x 1250
Prijs	€	1.915,00

- Tot 405mm brede werkstukken



Vlakschuurmachine voor houten panelen en balken.

Troeven:

- Uitstekende schuurprestaties ook bij brede en ook bij lange werkstukken.
- Continue variabele voedingsnelheid van 0,5 tot 3 m/min voor optimale slijpresultaten
- Met afzuigmond voor externe stofafzuiging.
- Krachtige motor
- Eenvoudige hoogte-instelling met handwiel en schaal aanduiding.
- Handvat en wielen voor eenvoudig transport.
- Eenvoudige en snelle bandwissel.

Geschikt voor:

- de veeleisende doe-het-zelver met beperkte ruimte.
- het op maat brengen en opschuren van massief hout en panelen.

Tip: geleverd zonder schuurrol, vergeet deze niet bij te bestellen.

Order nr.		715901405
Orig. nr.		ZSM405
Spanning	V	230
Vermogen motor	kW	1,5
Schuurbandsnelheid	m/s	0,5-3
Diameter afzuiging	mm	100
Slijpbreedte	mm	410
Slijpbandsnelheid	rpm	1440
Debiet	m ³ /u	1275
Gewicht	kg	38,00
Afmetingen (l x b x h)	mm	1030 x 950 x 1300
Prijs	€	969,00



Set werkstukstoppers - 4 delig. Praktische anti-sliphulp bij het zagen, schaven, lakken, etc. Set van 4 stuks.

Order nr.		715100004
Prijs	€	13,20

hozstar



Compact, draagbare gecombineerde vlak- en vandiktebank.

Troeven:

- Ideaal om te transporteren door klein en compact design
- Eenvoudige en precieze instelling van de schaafdikte (tot max. 2 mm)
- Automatische doorvoer van materiaal.
- Stalen tandielaangedreven inbrengrollen voor gelijke en constante voeding van het hout
- Rubberen ontladingsrollen werken zacht op het oppervlak tijdens het dikte schaven.
- Eenvoudig instelbare aluminium aanslag, draaibaar van 0° tot 45°, met schaal aanduiding
- Vlakschaafmessen zijn afgeschermd met een praktisch klemmechanisme.
- Geprofileerde boventafel, vervaardigd uit gietaluminium.
- Krachtige 230V motor

Geschikt voor:

- het precies vlakken van solide houten plakken en latten
- de thuiswerker en hobbyist.

Geleverd met:

- Mesgeleiding met 2 HSS vlakschaafmessen
- Ingebouwd opbergvak voor ADH250 en ADH305
- Geïntegreerde afzuiging met opvangzak ADH200

Tip: U kan een vergrotingsstuk bekomen van $\varnothing 60/100$ (715142427) of van $\varnothing 80/100$ (715142421) om aan te sluiten op uw afzuigingsstelsel.

Order nr.		715905200 ^M	715905250 ^M	715905305 ^M
Orig. nr.		ADH200 230V	ADH250 230V	ADH305 230V
Spanning	V	1x230	1x230	1x230
Werkhoogte minimum/maximum	mm	5 / 120	6/160	6 / 160
Maximum schaaftcapaciteit/doorgang	mm	2	2	2
Snelheid automatische aanvoer	m/min	7	7	7
Diameter schaafwielen	mm	50	50	50
Toerental	tpm	8500	8500	9500
Vermogen motor	kW	1.5	1,5	1.8
Afmetingen vlaktafel (l x b)	mm	757x210	1050x260	1075x310
Afmetingen vandiketafel (l x b)	mm	255x204	450x254	610x127
Schaafbreedte	mm	204	254	305
Aantal messen		2	2	2
Afzuiging diameter	mm	58	80	100
Gewicht	kg	29,00	40,00	42,00
Afmetingen (l x b x h)	mm	790 x 470 x 465	1105 x 550 x 570	1135 x 600 x 570
Prijs	€	432,00	679,00	769,00



• Tafelhoogteverstelling



• Onderstel met wielen

ADH260

ADH260 omgebouwd naar vandiktebank

Compact, verplaatsbare gecombineerde vlak- en vandiktebank, inclusief onderstel

Troeven:

- Ideaal om te verplaatsen
- Plaatsbesparend model
- Eenvoudige en precieze instelling van de schaafdikte tot max. 3 mm
- Automatische uniforme doorvoer van materiaal met anti terugslag apparaat.
- Eenvoudig instelbare aluminium aanslag, draaibaar van 90° tot 45°
- Geprofileerde boventafel, vervaardigd uit gietaluminium.
- Stalen tandielaangedreven inbrengrollen voor gelijke en constante voeding van het hout
- Rubberen ontladingsrollen werken zacht op het oppervlak tijdens het dikte schaven.
- Krachtige 230V motor

Geschikt voor:

- het precies vlakken van solide houten plakken en latten
- de thuiswerker en hobbyist.

Geleverd met:

- Mesgeleiding met 2 HSS vlakschaafmessen
- Onderstel met wielen
- Nederlandstalige handleiding

Order nr.	715903260 ^M	
Orig. nr.	ADH260	
Spanning	V	1x230
Maximum schaaftcapaciteit/doorgang	mm	3
Snelheid automatische aanvoer	m/min	5
Diameter schaaftwielen	mm	63
Toerental	tpm	6500
Vermogen motor	kW	2
Afmetingen vlaktafel (l x b)	mm	1030x280
Afmetingen vandiktetafel (l x b)	mm	260x400
Schaalbreedte	mm	260
Aantal messen		2
Afzuiging diameter	mm	100
Gewicht	kg	73,00
Prijs	€	1.155,00



Set vervangmessen (2 st.) voor vandiktteschaaf ADH260.

Order nr.	715913260 ^M	
Prijs	€	55,90

hozstar

NEW IN 230V

3KW



hoogteindicator

Gecombineerde vlak- en vandikteschaafmachine. 310 mm schaafbreedte met onderbouw.

Troeven:

- Ergonomisch en plaatsbesparend model
- Eenvoudige en precieze instelling van de schaafdikte (tot max. 3 mm).
- Automatische doorvoer.
- Eenvoudig instelbare aluminium aanslag, draaibaar van 0° tot 45°.
- Geprofileerde schaafafel, vervaardigd uit geribd gietaluminium
- **Digitale hoogte indicator** op vandiketafel met schaal tot 20 cm laat geschikte dikte schaven toe
- Tafel van de dikteschaaf uit gietijzer met gepoliseerd bovenvlak, 4-punts gelagerd.
- Gegolfde werktafel voor minder wrijvingsweerstand
- Met schaafmesinstelling met maataanduiding
- Krachtige en duurzame ketting aandrijving van inbreng en ontladingsrollen.
- Stalen tandwiel-aangedreven inbrengrollen voor gelijke en constante voeding van het hout
- Rubberen ontladingsrollen werken zacht op het oppervlak tijdens het dikte schaven.
- Ingebouwde, verplaatsbare afzuigmond die zowel voor de langsschaaf als voor de dikteschaaf kan gebruikt worden.
- Krachtige motor.
- Met noodschakelaar.

Geschikt voor:

- de ambitieuze thuiswerker of professional.
- voor het schaven en afwerken van alle houtsoorten, planken en latten.

Geleverd met:

- Mesgeleiding met 3 HSS messen
- Nederlandstalige handleiding

Order nr.		715903301 [®]	715903300 [®]
Orig. nr.		ADH310 230V	ADH310 400V
Spanning	V	1x230	3x400
Werkhoogte minimum/maximum	mm	250	250
Maximum schaafcapaciteit/doorgang	mm	3	3
Snelheid automatische aanvoer	m/min	7	7
Diameter schaafwielen	mm	70	70
Toerental	tpm	5300	5300
Vermogen motor	kW	2,75	2,75
Afmetingen vlaktafel (l x b)	mm	1247x330	1247x330
Afmetingen vandiketafel (l x b)	mm	520x312	520x312
Schaafbreedte	mm	310	310
Aantal messen		3	3
Afzuiging diameter	mm	100	100
Gewicht	kg	170,00	170,00
Afmetingen (l x b x h)	mm	1300 x 1000 x 1300	1300 x 1000 x 1300
Prijs	€	2.190,00	2.115,00

hozstar



Vervangmessen (3 stuks) voor dikteschaaf machine ADH310

Order nr.		715913311 [®]
Orig. nr.		5913311
Prijs	€	108,00

MACHINES

Langgatboormachines

holzkraft



1,1 kW

Compacte langgatboormachine.

Troeven:

- Plaatsbesparend model.
- Boorkop met dubbele geleiding
- Hoogteverstelling boorkop met schaalaflezing
- Eenhandsbediening voor snel en precies boren
- Stabiele constructie uit staal en gietijzer
- Deuvelinrichting met rasterindeling voor gemakkelijk positioneren van de deuvelgaten
- Aparte noodstop
- Europese makelij

Geschikt voor:

- de veeleisende houtbewerker

Standaard geleverd met:

- Deuvelinrichting
- Wescott boorkop
- Excenterspanner

Tip: vergeet uw optionele hoekaanslag met gradenverdeling 715336718, alsook uw optionele verplaatsbare voet UF230 71690230, niet bij te bestellen. Toestel kan eveneens utigerust worden met een laser voor het markeren van de boorlijnen 715336668.



Deuvelinrichting



Dubbele geleiding

MACHINES

Order nr.		715326617 ^M
Orig. nr.		LLB16H
Spanning	V	3x400
Vermogen motor	kW	1,1
Afmetingen tafel	mm	500x200
Boorbreedte	mm	200
Boordiepte	mm	150
Hoogteverstelling boorkop	mm	150
Toerental	tpm	3000
Gewicht	kg	120,00
Afmetingen (l x b x h)	mm	560 x 740 x 1320
Prijs	€	2.085,00

holzkraft

Set langgatboren 5-delig rechts voor LLB16H.



Troeven:

- 5-delig
- Rechtsdraaiend
- Duits fabrikaat

Standaard geleverd met:

- ø 8/10/12/14 mm met een schacht van ø 12,8 mm
- ø 16 mm met een schacht van ø 15,8 mm
- Houten koffer

Order nr.		715333682 ^M
Prijs	€	119,00

holzkraft



Hoekaanslag LLB 16H

Order nr.		715336718 ^M
Prijs	€	201,00

Houtdraaibanken

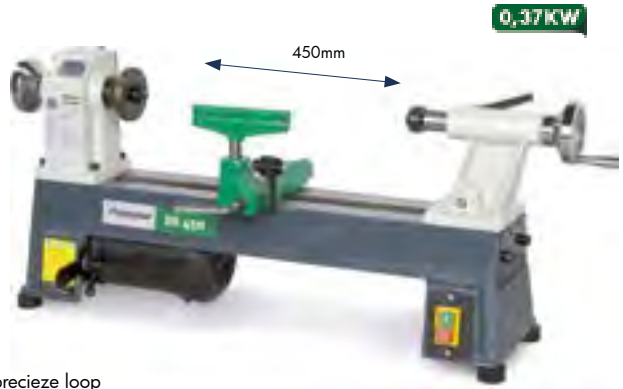

Compacte houtdraaibanken voor tal van toepassingen.

Troeven:

- Torsieresistent grijs gietijzeren bed voor een vlotte en precieze loop
- Kop en tegenpunt eveneens uit grijs gietijzer vervaardigd
- Kijkvenster voor het controleren van de gekozen snelheden.
- 5 gamma's snelheden, via V-snaar
- Gemakkelijk verstellen van de snelheden door middel van hendels
- Eenvoudig verstelbare beitelsteun
- Tegenpunt met 50 mm verplaatsing, handwiel en klemhendel
- Bijzonder stille loop

Geschikt voor:

- enthousiaste doe-het-zelver

Standaard geleverd met:

- Houder voor gereedschap 15 mm,
- Vlakschijf diameter 7 cm
- meelopend center.

Tip: geleverd zonder 4-weg klauwplaat 715931021 of beitelset 715931011, vergeet deze niet bij te bestellen. U kunt uw draaibank ook verlengen tot 1.000 mm met de bedverlenging 715920451.

Order nr.		715920450
Orig. nr.		DB450
Spanning	V	230
Centerhoogte	mm	127
Centerafstand	mm	450 / Opt. 1000
Losse kop	MK	2
Maximum draaidiameter	mm	254
Type draad op spindel	M	33x3.5
Toerental	tpm	680, 1000, 1400, 2000, 2800
Versnellingen		5
Vermogen motor	kW	0.37
Gewicht	kg	35,00
Afmetingen (l x b x h)	mm	820 x 300 x 430
Prijs	€	321,00



8-delige beitelset voor houtdraaibanken.

Standaard geleverd met:

- 3 x holbeitel
- 1 x afsteeksleutel
- 1 x rondbeitel
- 2 x rechte draaibeitel
- 1 x schraapstaal
- In houten koffer



Geschikt voor:

- Alle houtdraaibanken, zoals DB900, DB1100, etc.

Order nr.		715931011
Prijs	€	99,90



Vaste bril voor houtdraaibanken DB

Order nr.	715931050	715931030
Voor type	DB900	DB1100
Prijs	€ 40,90	39,90



• Digitale toerental-aanduiding

VARIO



DB900



DB1100

Houtdraaibank met variabele snelheidsregeling voor professioneel gebruik.

Troeven:

- Stabiele staal/gietijzeren constructie.
- Krachtige 230 V motor met aluminium behuizing.
- Traploos regelbaar toerental van 500 tot 2000 t/min.
- Met digitale aanduiding van het toerental.
- Vlug schakelen van snelheden door middel van hendel aan bedienerszijde
- Eenvoudig verstelbare beitelsteun
- Het motorblok met de spindel kan tot 180° zijdelings gedraaid worden.
- De losse kop wordt door middel van een snelspanner op het machinebed vastgemaakt.

Geschikt voor:

- de professionele houtbewerker, ieder werkplaats, thuiswerker

Standaard geleverd met:

- Houder voor gereedschap 30 mm
- Vlakschijf ø 15 cm
- Meelopend center
- Machinevoet.

Tip: geleverd zonder 4-weg klauwplaat 715931021 of beitelset 715931011, vergeet deze niet bij te bestellen. U kunt uw draaibank ook uitrusten met een vaste bril of copieerapparaat.



Draaibare kop



Vario 500-2000 tpm

MACHINES

Order nr.		715920900 ^M	715921100 ^M
Orig. nr.		DB900	DB1100
Spanning	V	230	230
Centerhoogte	mm	153	179
Centerafstand	mm	900	1100
Losse kop	MK	2	2
Maximum draaidiameter	mm	306	358
Type draad op spindel	M	33x3,5	33x3,5
Toerental	tpm	500-2000	500-2000
Versnellingen		10 + vario	10 + vario
Vermogen motor	kW	0,55	0,75
Gewicht	kg	85,00	92,00
Afmetingen (l x b x h)	mm	1380 x 330 x 370	1620 x 340 x 430
Prijs	€	649,00	899,00



Set meenemers voor houtdraaibanken.



Troeven:

- 3st. in set.
- Opname MK2.

Order nr.	715931056 ^M
Prijs	€ 50,90



Buiten draaiinrichting voor draaibank DB1100. Massieve stalen constructie.



Geleverd met:

- Bedverlenging
- Opname voor draaibeitelhouder

Order nr.	715931052 ^M
Prijs	€ 96,90



1,5KW VARIO

Houtdraaibank met variabele toerentalregeling voor professioneel gebruik.

Troeven:

- Stabiele staal/gietijzeren constructie.
- Krachtige 230 V motor met aluminium behuizing.
- 2 Traps variabele toerentalregeling van 0 tot 1200 en 0 tot 3200 t/min over 2 mechanische snedheden met riemen
- Met digitale aanduiding van het toerental.
- Keuzeschakelaar voor wijzerzin en tegen wijzerzin draaien
- Vlug schakelen van snelheden door middel van hendel aan bedienerszijde
- Eenvoudig verstelbare beitelsteun
- Het motorblok met de spindel kan tot 180° zijdelings gedraaid worden.
- De losse kop wordt door middel van een snelspanner op het machinebed vastgemaakt.

Geschikt voor:

- de professionele houtbewerker, ieder werkplaats, thuiswerker

Standaard geleverd met:

- Houder voor gereedschap 30 mm
- Vlakschijf ø 15 cm
- Meelopend center
- Machinevoet.

Tip: geleverd zonder 4-weg klauwplaat 715931021 of beitelset 715931011, vergeet deze niet bij te bestellen. U kunt uw draaibank ook uitrusten met een copieerapparaat.



Variabel toerental

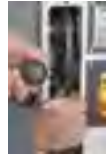

Snel wisselen van de riem

Order nr.	715921200 ^M	
Orig. nr.	DB1202	
Spanning	V	230
Centerhoogte	mm	230
Centerafstand	mm	1185
Losse kop	MK	2
Maximum draaidiameter	mm	460
Type draad op spindel	M	33x3,5
Toerental	tpm	0-3200
Versnellingen		2 + vario
Vermogen motor	kW	1,5
Gewicht	kg	185,00
Afmetingen (l x b x h)	mm	2060 x 500 x 1200
Prijs	€	2.255,00



Klauwplaten voor houtdraaibanken.



Troeven:

- Met opname zware metrische draad M33x3,5
- Zelfcenterende klauwplaat 4 bekken ø 100 mm (715931021)
- Zelfcenterende klauwplaat 4 bekken ø 100 mm (715931023) met schroefinzet en verwisselbare klauwen
- Onafhankelijke verstelbare 4 klauw ø 150 mm (715931020)

Geschikt voor:

- Alle houtdraaibanken met een aansluiting M33x3,5
- Holzstar houtdraaibanken DB450 / DB900 / DB1100 / DB1202

Order nr.	715931020 ^M	715931021 ^M	715931023 ^M
Type	klauwen onafhankelijk	zelfcenterende klauwen	wisselklauwen met schroefinzet
Diameter	mm 150	100	100
Aansluiting	M33x3,5	M33x3,5	M33x3,5
Opspancapaciteit	buiten 42-157mm - binnen 22-59mm	buiten 51-78mm - binnen 40-63mm	buiten 50-90mm - binnen 38-73mm
Prijs	€ 56,90	94,90	126,00



Kopieereenheid voor houtdraaibanken DB.



Troeven:

- Tijdsbesparend
- Torsieresistente aluminium profieldrager
- Grijs gietijzeren wagen met stalen geleidingen

Geschikt voor:

- Houtdraaibanken DB900 / DB1100 / DB1202
- Het herhalen van identieke werkstukken met identieke profielen

Geleverd met:

- Hulpstukken voor langs- en dwarsdraaien
- Bevestigingsbeugel voor templates
- Diamantpunt
- Sonde
- Spanenafscherming

Order nr.	715931101 ^M	715931102 ^M	715931060 ^M
Voor type	DB 900	DB1100	DB1202
Maximum draaidiameter	mm 306	210	210
Prijs	€ 226,00	213,00	395,00

Zaagmachines



5 in 1



Met optionele voet



Schaven



Frezen



Shaven



Zagen

5-voudige combinatie houtbewerkingsmachine voor zagen, vlakschaven, vandikte schaven, frezen en langgatboren.

Troeven:

- Compacte en mobiele machine, ideaal instapmodel voor de houtbewerker met beperkte werkruimte
- Loopwagen voor materiaalaanvoer bij zagen en frezen
- Regelbare hoekaanslag en zijaan slag voor precies werk
- Afzuigsysteem aansluitmogelijkheid voor schoon werk
- Geschikt voor mobiel gebruik op werf of als stationaire machine in de werkplaats

1. Frezen:

- Voor assemblage van latten en planken
- Loopwagen voor veilige en gemakkelijke werkstukaanvoer

2. Vlakschaven:

- Met twee schaafmessen met een breedte van 154 mm
- Makkelijk verstelbare aluminium aanslag van 90° tot +45°

3. Vandikte schaven:

- Voor het bewerken van werkstukken tot 92 mm hoogte
- De conversie vlakschaaf-vandiktebank gebeurt in enkele eenvoudige stappen.

4. Zagen:

- Zeer praktische hoekaanslag
- Multifunctionele zijaan slag voor langzagen
- Zaagblad 200 x 30 x 2,6 mm Z20 voor max. zaaghoogte 65 mm

5. Langgatboren:

- Voor het eenvoudig maken van groeven en langgaten

Geleverd met:

- Schaafas voor 2 schaafmessen
- 2 schaafmessen
- Zaagblad 200 x 30 x 2,6 mm Z20
- Loopwagen voor zagen en frezen
- Multifunctionele aanslag voor langzagen en vandikte schaven
- Hoekaanslag
- Langgatboormachine met spanner
- Duwstok

Tip: vergeet uw optionele voet met wielen 715916005, niet bij te bestellen

Order nr.	715905600 	
Algemeen		
Orig. nr.		UMK6
Spanning	V	230
Vermogen motor	kW	1
Diameter afzuigmond	mm	58
Afzuigmond zaagblad	mm	21
Cirkelzaag		
Koers loopwagen	mm	500
Maximum zaaghoogte	mm	65
Afmetingen loopwagen	mm	120x740
Toerental zaagblad	min-1	4200
Werktafel	mm	620x300
Max. diameter zaagblad	mm	200
Schaven		
Werkbreedte schaven	mm	154
Tafellengte schaven	mm	620
Max. spaanafname schaven	mm	1,5
Toerental schaafas	min-1	6000
Schaafmessen		2
Vandikte		
Werkbreedte	mm	154
Tafellengte vandikte	mm	320
Doorvoerbreedte	mm	154
Doorvoerhoogte min.-max.	mm	9-92
Werkbreedte	mm	154
Maximum spaanafname	mm	1
Voedingssnelheid	m/min	7
Afzuigmond	mm	50
Frezen		
Spilopname	mm	12
Opname frees	mm	6/8
Hoogteverstelling	mm	0-42
Spindeltoerental	min-1	9000
Langgatboren		
Opname	mm	6/8/10
Opname	mm	6/8/10
Maximum hoogte	mm	95
Maximum breedte	mm	60
Maximum diepte	mm	45
Werktafel langgatboren	mm	260x125
Boorkop klembereik	mm	13
Gewicht	kg	52,00
Afmetingen (l x b x h)	mm	880 x 835 x 345
Prijs	€	1.049,00



Voet met wielen voor UMK6.

N° de cde	715916005 
N° orig.	5916005
Prix	€ 60,50



Set langgatboren M6, M8, M10 voor UMK6.

Order nr.	715916002 
Orig. nr.	5916002
Maten	mm 6, 8, 10
Prijs	€ 42,90



HBS 251 met optionele voet



HB351-2 met optionele voet



HBS400

Verticale bandzaagmachines voor hout en kunststof voor modelbouw en hobby.

Troeven:

- Plaatstalen constructie.
- Aluminium lengteaanslag met excentrische snelspanning en schaalverdeling.
- Zaagtafel uit gietijzer met geslepen oppervlak kantelbaar van 0-45° met schaalverdeling.
- 3-rollen bandzaaggeleiding zowel boven- als onderaan.
- Aandrijfwielen uit giet-aluminium met een coating voor een hogere levensduur van de zaagbladen.
- Krachtige 230V motor
- HBS400 en HBS471:
 - met onderstel,
 - snelspanning van de lintzaag d.m.v. excenter hendel
 - grijs gietijzeren loopwielen voor vlotte werking
- HBS471:
 - 3 rollen zaaggeleiding met fijnafstelling
 - Zaagbladspanning kan uitwendig afgelezen worden via scherm in de deur

Geschikt voor:

- HBS251 en HBS351-2 modelbouw en hobby
- HBS400 en HBS471 voor professioneel gebruik

Standaard geleverd met:

- 1 x zaagblad.
- HBS400 en HBS471 met geribde aluminium steunprofiel

Tip: geleverd zonder hoekaanslag en zonder sokkel, vergeet deze niet bij te bestellen.

Order nr.		715900251 ^M	715900351 ^M	715900410 ^M	715900471 ^M
Orig. nr.		HBS251	HBS351-2	HBS400	HBS471
Spanning	V	230	230	230	230
Lengte zaagblad	mm	1790	2490	3378	3455
Diameter afzuiging	mm	58	100	2x100	100
Maximum zaagbreedte met aanslag	mm	121	299	266	390
Maximum zaagbreedte zonder aanslag	mm	245	345	416	465
Maximum zaaghoogte	mm	120	200	305	285
Diameter vliegwiel	mm	250	350	426	470
Zaagsnelheid	m/min	696	438-900	460/980	460/980
Grootte werktafel (l x b)	mm	290x290	548x400	530x480	535x485
Vermogen motor	W	350	1000	1500	1500
Gewicht	kg	32,00	70,00	135,00	146,00
Afmetingen (l x b x h)	mm	420 x 330 x 880	520 x 380 x 1155	765 x 520 x 1750	800 x 490 x 2000
Prijs	€	349,00	709,00	1.425,00	1.529,00



Verticale precisie lintzaagmachine voor hout voor de veeleisende ambachtsman.

Troeven:

- De stabiele machinebehuizing en de solide stalen voet geven de machine een geruisloze werking.
- Grote zaagtafel uit gietijzer met geslepen en gepolierd oppervlak, kantelbaar van -10° tot +45° met schaalverdeling.
- Comfortabel zagen dankzij de laserverlichting op de zaagsnede.
- Zaagbandspanning dmv een excentrische hendel aan de achterzijde.
- Standaard met 2 snelheden.
- Precisie 3-rollen bandzaaggeleiding zowel boven als onderaan.
- Snelle hoogterstelling van de tafel dmv een draaiknop en tandlat met een schaalverdeling.
- Soepele alu-parallelaanslag met excentrische klemming en loep.
- Aandrijfwielen uit giet-aluminium met een speciaal coating voor een hogere levensduur van de zaagbladen.
- Automatisch uitschakelen bij openen deur.

Geschikt voor:

- de veeleisende ambachtsman.

Standaard geleverd met:

- 1 x zaagblad
- 1 x hoekaanslag tot 60°.
- 1 x parallelaanslag
- Nederlandstalige handleiding



HBS351 met optionele voet



HBS433

Order nr.		715153501 ^(M)	715154301 ^(M)	715154303 ^(M)	715155303 ^(M)
Orig. nr.		HBS351	HBS431	HBS433	HBS533
Spanning	V	230	230	3x400	3x400
lengte zaagblad	mm	2562	3345	3345	3865
Maximum zaagbreedte met aanslag	mm	321	370	370	474
Maximum zaagbreedte zonder aanslag	mm	346	410	410	514
Maximum zaaghoogte	mm	200	270	270	270
Diameter vliegwiel	mm	356	430	430	530
Zaagsnelheid	m/min	650-400	900-450	900-450	850-430
Zaagbladgeleiding		boven-onder	boven-onder	boven-onder	boven-onder
Diameter afzuiging	mm	100	2x100	2x100	2x100
Hellingshoek werktafel	°	-10+45	-10+45	-10+45	-10+45
Grootte werktafel (l x b)	mm	495x356	610x431	610x431	680x530
Vermogen motor	W	550	1500	1500	2250
Gewicht	kg	80,00	130,00	130,00	163,00
Afmetingen (l x b x h)	mm	610 x 445 x 1753	768 x 512 x 2048	768 x 512 x 2048	1024 x 793 x 2048
Prijs	€	989,00	1.709,00	1.879,00	2.019,00



Machievoet voor verticale lintzaagmachine voor hout HBS



Geschikt voor:

- HBS251 of HBS351-2

Order nr.		715910813 ^(M)	715910812 ^(M)
Omschrijving		machievoet	machievoet
HBS	Tpi	HBS251	HBS351-2
Prijs	€	53,50	66,50



Hoekaanslag voor verticale lintzaagmachines voor hout HBS



Order nr.		715910810 ^(M)	715910814 ^(M)
Omschrijving		hoekaanslag	hoekaanslag
HBS	Tpi	HBS251	3122 + 351-2
Prijs	€	11,30	27,90

MACHINES



Industriële verticale lintzaagmachine.

Troeven:

- Machine met een hoog eigengewicht, constructie uit één stuk garanderen een stille en rustige werking.
- Grote zaagtafel uit gietijzer met geslepen en gepolierd oppervlak kantelbaar van 0-20° met schaalverdeling.
- Laserlijn om vlug en precies te werken
- Gepatenteerde hoogteverstelling van de tafel dmv een draaiknop en tandlat met een schaalverdeling.
- Zaagbandspanning dmv een excentrische hendel aan de achterzijde.
- Keramische bandzaaggeleiding 3 rollen zowel boven als onderaan, met fijnafstelling
- Geïntegreerde weergave van de zaagbandspanning voor verschillende zaagbandbreedtes.
- Grote gietijzeren aanslag.
- Aandrijfwielen uit gietijzer met een speciaal coating voor een hogere levensduur van de zaagbladen.

Geschikt voor:

- de industrie, de betere werkplaats

Standaard geleverd met:

- 1 x zaagblad
- 1 x hoekaanslag tot 60°
- 1 x zware gietijzeren parallelaanslag
- Nederlandstalige handleiding

Order nr.		715155313 ^W	715156303 ^W
Orig. nr.		HBS533S	HBS633S
Spanning	V	3x400	3x400
Lengte zaagblad	mm	4190	4600
Maximum zaagbreedte met aanslag	mm	465	570
Maximum zaagbreedte zonder aanslag	mm	510	610
Maximum zaaghoogte	mm	350	400
Diameter vliegwiel	mm	530	630
Zaagsnelheid	m/min	1400	1615
Zaagbladgeleiding		boven-onder	boven-onder
Diameter afzuiging	mm	2x100	2x100
Hellingshoek werktafel	°	0+20	0+20
Grootte werktafel (l x b)	mm	750x530	830x600
Vermogen motor	W	3750	3500
Gewicht	kg	305,00	380,00
Afmetingen (l x b x h)	mm	1000 x 720 x 2040	1190 x 750 x 2060
Prijs	€	3.145,00	4.019,00



Lintzaagblad voor lintzaagmachines Holzstar en Holzkraft HBS.

Geschikt voor:

- Verticale lintzaagmachines voor hout met zelfde specificaties
- Holzstar HBS en Holzkraft HBS serie

Order nr.	Voor type	Tandsteek T	Voor	Afmetingen (l x b x h)		Prijs €
				mm		
715162512	HBS251	6	hout/kunststof	1790 x 12.7 x 0.5		13,90
715163206	HBS251	14	hout/kunststof/metaal	1790 x 6.4 x 0.64		13,90
715162506	HBS251	8	hout/kunststof	1790 x 6.4 x 0.64		13,90
715163515	HBS351	4 Hook	hout/kunststof	2562 x 16 x 0.8		16,90
715163512	HBS351	4 Skip	hout/kunststof	2562 x 12.7 x 0.64		16,90
715163506	HBS351	6 skip	hout/kunststof	2562 x 6.4 x 0.64		16,90
715163216	HBS 3122	14	hout/kunststof	2240 x 6.4 x 0.64		14,90
715163112	HBS 3122	8	hout/kunststof	2240 x 12.7 x 0.64		14,90
715163115	HBS 3122	6	hout/kunststof	2240 x 12.7 x 0.64		14,90
715163106	HBS 3122	14	hout/kunststof/metaal	2240 x 6.4 x 0.64		14,90
715163712	HBS 351-2	4	hout/kunststof	2490 x 12.7 x 0.64		15,90
715163226	HBS 351-2	14	hout/kunststof/metaal	2490 x 6.4 x 0.64		15,90
715163715	HBS 351-2	4 Hook	hout/kunststof	2490 x 16 x 0.8		15,90
715163706	HBS 351-2	6	hout/kunststof	2490 x 6 x 0.5		15,90
715163606	HBS351S	4 Skip	hout/kunststof	2470 x 6.4 x 0.64		15,00
715164310	HBS431/433	4 Hook	hout/kunststof/alu	3345 x 9.4 x 0.64		17,90
715164315	HBS431/433	4 Hook	hout/kunststof/Alu	3345 x 15 x 0.5		19,90
715164320	HBS431/433	4	hout/kunststof/alu	3345 x 20 x 0.5		20,90
715164325	HBS431/433	4 Hook	hout/kunststof/Alu	3345 x 25 x 0.5		20,90
715165328	HBS533	10-14	hout			37,50
715165310	HBS533	4 Hook	hout/kunststof/alu	3865 x 9.5 x 0.64		18,90
715165315	HBS533	4 Hook	hout/kunststof/alu	3865 x 16 x 0.8		19,90
715165320	HBS533	4	hout/kunststof/Alu	3865 x 19 x 0.8		20,90
715165325	HBS533	4 Hook	hout/kunststof/Alu	3865 x 27 x 0.9		22,90
715165311	HBS533S	4 Hook	hout/kunststof/alu	4190 x 9.5 x 0.64		19,90
715165316	HBS533S	4 Hook	hout/kunststof/alu	4190 x 16 x 0.8		21,90
715165321	HBS533S	4	hout/kunststof/alu	4190 x 19 x 0.8		22,90
715165326	HBS533S	4 Hook	hout/kunststof/Alu	4190 x 27 x 0.9		29,90
715166310	HBS633S	4 Hook	hout/kunststof/alu	4600 x 9.5 x 0.64		20,90
715166315	HBS633S	4 Hook	hout/kunststof/alu	4600 x 16 x 0.8		21,90
715166320	HBS633S	4	hout/kunststof/Alu	4600 x 19 x 0.8		23,90
715166325	HBS633S	4 Hook	hout/kunststof/Alu	4600 x 25 x 0.5		28,70
715166326	HBS633S	4	Hout/kunststof/Alu	4600 x 25 x 0.6		27,90



• Met LED verlichting

120W



DKS502 VARIO

Compacte decoupeerzaag of figuurzaag met variabel toerental

Troeven:

- Grote uitlading voor diepe werkstukken, 400 mm
- Werktafel zwenkbaar tot van -45° tot 0°
- Variabel toerental voor het optimaal verzagen van diverse materialen.
- Gietijzeren onderstel en zaagarm voor een rustige loop.
- Ingebouwde blaastuit blaast stof direct weg van de zaaglijn.
- Transparante afdekkap in hoogte verstelbaar.
- Met flexibele LED verlichting

Geschikt voor:

- modelbouwers, maquettebouw.
- de verwerking van zachthout (tot 50 mm dik), kunststof, piepschuim, ... fijn zaagwerk

Tip: geleverd zonder decoupeerzagen, vergeet deze niet bij te bestellen.

Order nr.		715900504 M
Orig. nr.		DKS502 VARIO
Spanning	V	230
Maximum snijdiepte	mm	50
Uitlading	mm	406
Lengte zaagblad	mm	133
Aantal omwentelingen	rpm	700-1400
Tafelafmetingen	mm	310x480
Vermogen	W	120
Diameter afzuiging	mm	38
Gewicht	kg	12,70
Afmetingen (l x b x h)	mm	310 x 740 x 440
Prijs	€	140,00



Decoupeerzaagbladen voor decoupeer zaagmachines Holzstar en Holzkraft DKS.

VE = verpakkingseenheid.

Order nr.		715911628 M	715911660 M	715911661 M
Voor type		DKS	DKS	DKS
Tandsteek	T	10	6	12
Voor		hout/kunststof/gips	hout/kunststof	metaal
VE		6	6	6
Afmetingen (l x b x h)	mm	127 x 3 x 0.25	127 x 6 x 0.4	127 x 6 x 0.4
Prijs/VE	€	13,90	14,90	14,90



VOOR PEN- EN IJZERZAAGBLADEN



DKS530

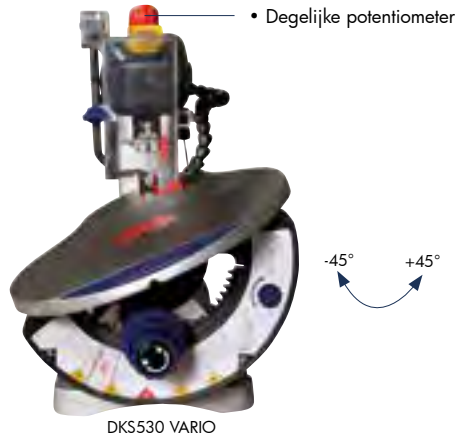

DKS530 VARIO

Figuurzaagmachine voor het grotere knutsel- en modelbouwwerk met traploos regelbare snelheid van het zaagblad.

Troeven:

- Traploos instelbare snelheid van het zaagblad (van 400 tot 1600 omwentelingen/min.)..
- Schuinstelbare werktafel langs beide zijden van -45° tot +45°;
- Gietijzeren constructie en tafel.
- Met opslagruimte voor zaagbladen.
- Zware en stabiele machine.
- Een ingebouwde blazer verwijdert spaanders van de werktafel bij het zagen.
- Een doorzichtige plexiglas beschermkap over het zaagblad zorgt voor een optimale bescherming van de ogen.
- Zaagbladopname voorzien voor pen- en ijzerzaagbladen.
- Universele zaagbladopname.
- Ingebouwde afzuigbek..

Geschikt voor:

- het bewerken van hout, kunststof, plexiglas, gips of dunne metalen.
- het grotere knutsel- en modelbouwwerk

Tip: geleverd zonder decoupeerzaagblad, vergeet deze niet te bestellen

Order nr.		715900505
Orig. nr.		DKS530 VARIO
Spanning	V	230
Maximum snijdiepte	mm	53
Uitlading	mm	406
Lengte zaagblad	mm	127
Aantal omwentelingen	rpm	500-1550
Tafelafmetingen	mm	310x480
Vermogen motor	W	225
Gewicht	kg	20,50
Afmetingen (l x b x h)	mm	740 x 310 x 440
Prijs	€	379,00



Decoupeerzaagbladen voor decoupeer zaagmachines Holzstar en Holzkräft DKS.

VE = verpakkingseenheid.

Order nr.		715911628	715911660	715911661
Voor type		DKS	DKS	DKS
Tandsteek	T	10	6	12
Voor		hout/kunststof/gips	hout/kunststof	metaal
VE		6	6	6
Afmetingen (l x b x h)	mm	127 x 3 x 0.25	127 x 6 x 0.4	127 x 6 x 0.4
Prijs/VE	€	13,90	14,90	14,90



• Laserlijn



• Werkstukaanleg

Plinten afkort en verstekzaag met trekfunctie

Troeven:

- Trekfunctie met dubbele stabiele geleiding voor het exact verzagen van brede werkstukken
- Krachtige motor
- Grote zaagcapaciteiten
- Verstek en neiging traploos instelbaar
- **Laserlijn** verlicht de zaaglijn en maakt snel en precies zagen superegemakkelijk
- Robuuste gietaluminium onderplaat
- Compact en draagbaar
- Zijaanslag met uitschuifbare zijwaartse verlengingen (werkstuksteun) voor lange werkstukken
- 2-voudig instelbare diepteaanslag voor het zagen van groeven

Geschikt voor:

- De veeleisende doe-het-zelver, hersteller, schrijnwerker
- Het precies afkorten en verstekzagen van houten plinten, latten, parket
- Het afkorten van Aluminium en plastic profielen

Geleverd met:

- Afzuigmond voor meegeleverde stofzak of aansluiting van externe stofafzuiging
- Met zaagblad diam. 305 x 3,2 x diam. 30 mm Z48
- C-Werkstukkleem
- Met spanklem voor vastklemmen op werktafel
- Nederlandstalige handleiding

Order nr.	715702305 M	
Orig. nr.	KGZ305E	
Neiging 0°/Verstek 0°	mm	100x340
Neiging 45°/Verstek 0° links	mm	40x340
Neiging 45°/Verstek 0° rechts	mm	40x340
Neiging 0°/Verstek 45° links	mm	100x240
Neiging 45°/Verstek 45° rechts	mm	40x240
Diameter zaagblad	mm	305
Vermogen motor	kW	2,0
Toerental	tpm	4500
Gewicht	kg	22,00
Afmetingen (l x b x h)	mm	835 x 570 x 790
Prijs	€	299,00



Cirkelzaagbladen voor KGZ305E / KGZ3050.

Order nr.	715260305 M		715260306 M	
Tandsteek	T	60	72	
Afmetingen (l x b x h)	mm	300 x 3,2 x 30	300 x 3,2 x 30	
Prijs	€	162,00	160,00	



PRO



Professionele afkort- en verstekzaag met trekfunctie.

Troeven:

- Trekfunctie met dubbele stabiele geleiding voor het exact verzagen van brede werkstukken
- Krachtige 1,8kW motor
- Zaagcapaciteit tot 100x310mm
- Verstek links 45°/rechts 60° en neiging 45° links/rechts
- Verstek vast instelbaar op 0°/15°/22,5°/31,6°/45°/60° (60°rechts enkel)
- Verstek vast instelbaar op 31,6° voor het zagen van sierlijsten en moulures
- Verstekinstelling met fijnregeling aanpasbaar
- Laserlijn verlicht de zaaglijn en maakt snel en precies zagen kinderspel
- Robuuste gietaluminium onderplaat
- Compact en draagbaar
- Grote zijaanslag met links en rechts uitschuifbare zijwaartse verlengingen (werkstuksteun) voor lange werkstukken
- Instelbare diepteaanslag voor het zagen van groeven
- Werkstukkleem
- Met spanklem voor vastklemmen op werktafel
- Afzuigmond voor meegeleverde stofzak of aansluiting van externe stofafzuiging

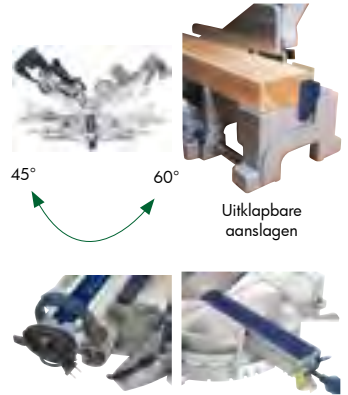

Geschikt voor:

- het verzagen van kroonlijsten, sierlijsten en moulures
- het verzagen van parket en laminaat
- het verzagen van plinten en balken

Standaard geleverd met:

- Cirkelzaagblad 305 x 3,2 x 30 mm

Tip: maak gebruik van de optionele samenklapbare, universele werktafel/rollenbaan (ref. 715900020) om precies en eenvoudig te werken.

Order nr.	715701305 M	
Orig. nr.	KGZ3050	
Neiging 0°/Verstek 0°	mm	102x310
Neiging 45°/Verstek 0° links	mm	60x310
Neiging 45°/Verstek 0° rechts	mm	45x310
Neiging 0°/Verstek 45° links	mm	102x222
Neiging 0°/Verstek 60° rechts	mm	102x158
Neiging 45°/Verstek 45° rechts	mm	60x222
Neiging 45°/Verstek 60° rechts	mm	45x158
Diameter zaagblad	mm	305
Vermogen motor	kW	1,8
Spanning	V	230
Toerental	tpm	4200
Gewicht	kg	34,00
Afmetingen (l x b x h)	mm	1270 x 1160 x 760
Prijs	€	865,00



Cirkelzaagbladen voor KGZ305E / KGZ3050.

Order nr.	715260305 M		715260306 M	
Tandsteek	T	60	72	
Afmetingen (l x b x h)	mm	300 x 3,2 x 30	300 x 3,2 x 30	
Prijs	€	162,00	160,00	

MACHINES

Houtbewerkingsmachines



Met transportwielen



Hoekverstelling zaagblad 0° - 45°



Tafelverlenging breedte/lengthe

Mobiele, compacte tafelzaag voor op de werf of voor kleine werkplaatsen.

Troeven:

- Transportwielen en uitschuifbare handgreep voor snel transport
- Hoogte en zaaghoek vooraan snel instelbaar door middel van handwiel
- Kan zeer compact verticaal opgeborgen worden (standvoetjes)
- Parallelaanslag met excenterspanner met afleesliniaal
- Tafel in breedte instelbaar zonder werktuigen
- Geïntegreerde reinigbare stofzak

Geschikt voor:

- op de werf en kleine werkplaatsen
- het verzagen van planken, balken

Standaard geleverd met:

- Hardmetalen zaagblad ø 254 mm T36
- Tafel breedte en lengteverlengingen
- Parallelaanslag
- Werkstukduwer
- Lengteaanslag
- Stofzak
- Plooibaar onderstel

Tip: optioneel verhoogd mobiel onderstel voor ergonomisch werken op manshoogte 715912257.

Order nr.		715902255 M
Orig. nr.		TKS255M
Spanning	V	230 V - 50 Hz
Diameter zaagblad	mm	255
Toerental	tpm	4500
Vermogen motor	kW	1,8
Tafelafmetingen	mm	640 x 730
Maximum zaagbreedte met aanslag	mm	620
Maximum zaaghoogte	mm	56 - 80
Hoekinstelling zaagblad	°	0 - 45
Gewicht	kg	32,00
Afmetingen (l x b x h)	mm	760 x 800 x 500
Prijs	€	569,00

MACHINES

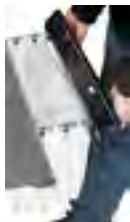

Stofzak voor TKS255M.

Order nr.		715912256 M
Prijs	€	18,50



Mobiel onderstel voor TKS255M.

Order nr.		715912257 M
Prijs	€	42,90

2kW

- Hoekaanslag
-45° tot +45°



- Parallelaanslag

- Ø315

- Transportwielen en handgrepen



Mobiele tafelzaag voor algemeen gebruik.

Troeven:

- Eenvoudig te verplaatsen dankzij onderstel met geïntegreerde transportwielen en handgrepen
- Groot en stabiel verzinkt stalen frame
- Neiging zaagblad 0°- 45° instelbaar zonder gereedschap
- Hoogte zaagblad instelbaar met handwiel en schaal aanduiding
- Aluminium aanvoertafel met aanslag en excenterspanner
- Glijdende wagen met kogellagers instelbaar van -45° tot +45° met snelspanhendel
- Afscherming van het zaagblad met afzuigslang

Geschikt voor:

- Interieurbouw, modelbouw
- Algemeen als bijzet tafelzaag.

Standaard geleverd met:

- Onderstel
- Tafel verlengingen langs/ dwars
- Parallelaanslag
- Hardmetalen zaagblad ø 315 mm T28

Order nr.				715903315
Orig. nr.				TKS315E 230V
Spanning	V			230
Diameter zaagblad	mm			315
Maximum verstek zaagblad	°			0-45
Afmetingen werktafel (l x b)	mm			800x550
Werkhoogte	mm			800
Toerental	tpm			2800
Vermogen motor	kW			2,0
Type motor				elektro
Diameter afzuiging (boven)	mm			38
Maximum snijdiepte	mm			83/60
Gewicht	kg			52,00
Prijs	€			388,00



Zaagbladen voor cirkelzaagmachines van Holzkraft en Holzstar.

Order nr.	Voor type	Asgat mm	Tandsteek T	Diameter	Type	Prijs €
715262518	TKS250 SC	30	18	250	all-round	53,50
715262524	TKS250 SC	30	24	250	langs- en afkortzagen in massief en plaat, met spaanbegrenzer	57,90
715262542	TKS250 SC	30	40	250	afkortzagen in massief en plaat, spaanloos zagen van plaat, kunststof, met geluidsreducerende laserlijn	84,50
715262581	TKS250 SC	30	80	250	afkortzagen in massief en plaat, spaanloos zagen van plaat, kunststof, met geluidsreducerende laserlijn	118,00
715263128	TKS315 Pro /TKS315E / FKS315-1500E/FKS315-2000E	30	28	315	langs- en afkortzagen in massief en plaat, met spaanbegrenzer	65,50
715263148	TKS315 Pro /TKS315E / FKS315-1500E/FKS315-2000E	30	48	315	afwerken en zagen van massief en plaat	107,00
715263160	TKS315 Pro /TKS315E / FKS315-1500E/FKS315-2000E	30	60	315	afwerken en zagen van massief en plaat	112,00

Houtbewerkingsmachines

holzstar

2,8KW

PRO



• Ø315

• Parallelaanslag met excenter zaagopspanning



• 400V

Universele precisie tafelzaag.

Troeven:

- Grootgedimensioneerde stalen werktafel, gegalvaniseerd tegen corrosie
- Tafelverlengingen kunnen eveneens rechts gemonteerd worden als dwarsuitbreiding
- Het zaagblad is neigbaar van 0 tot 45°, kan precies en eenvoudig worden afgeregeld tot op 1° nauwkeurig dankzij handwiel en schaalverdeling
- Groot centraal afzuigmond van ø 100 mm
- Hoogteverstelling van het zaagblad dankzij handwiel aan de bedienerszijde
- De stabiele zaageenheid laat precieze zaagsnedes toe.
- Krachtige industriële motor met rem, ontworpen om continu te werken
- Afscherming van het zaagblad met afzuigslang
- Parallelaanslag met excenter snelspanhendel
- Glijdende wagen met kogellagers instelbaar van -45° tot +45° met snelspanhendel
- Eenvoudig te verplaatsen dankzij onderstel met geïntegreerde transportwielen en handgrepen.

Geschikt voor:

- Diverse toepassingen bij binnenhuisinrichting, modelbouw of op de werf.
- Het verzagen van hardhout dankzij de krachtige motor

Standaard geleverd met:

- Onderstel
- Tafelverlenging
- Parallelaanslag
- Lengteaanslag zonder aluminium profiel
- Hardmetalen zaagblad ø 315 mm T36
- Nederlandstalige handleiding

Tip: vergeet uw extra tafelverlenging 715913251, extra zaagblad 715263128, en aluminium profiel voor lengteaanslag 715910315 niet bij te bestellen.

Order nr.		715903251 ^M	715903253 ^M
Orig. nr.		TKS315 PRO-230V	TKS315 PRO-400V
Spanning	V	230	3x400
Diameter zaagblad	mm	315	315
Maximum verstek zaagblad	°	0-45	0-45
Afmetingen werktafel (l x b)	mm	800x550	800x550
Werkhoogte	mm	810	810
Toerental	tpm	2800	2800
Vermogen motor	kW	2,2	2,8
Type motor		Elektro	Elektro
Maximum hoogte		90/50	90/50
Diameter afzuiging (boven)	mm	38	38
Diameter afzuiging (onder)	mm	100	100
Gewicht	kg	50,00	50,00
Afmetingen (l x b x h)	mm	2000 x 1360 x 1000	2000 x 1360 x 1000
Prijs	€	595,00	595,00

holzstar



Extra tafelstuk voor TKS 315 PRO.

Order nr.		715913251 ^M
Prijs	€	60,50

holzstar

2,5kW NEW IN 200V



• Ø254

- Zwenkbare telescopische aanslag tot 228cm



Aflezing op aanslag



Precisie hoogte- en hoekverstelling



Zaagblad 45° zwenkbaar

Universele tafelzaag voor beginners en de veeleisende doe-het-zelver.

Troeven:

- Robuust en precies ontwerp met premium rolwagen.
- Zware gietijzeren tafel voor vibratiearm werken en precies en rechte zaagsnedes
- Kogelgelagerde rolwagen met vastgeschroefde armsteun
- Telescopische aanslag met lensvergroting voor precieze aflezing tot 228 cm
- Hoekaanslag van -45 tot +45° instelbaar.
- Zaagblad van 0 tot 45° neigbaar via draaiknop op tandlat.
- Zaagblad in hoogte instelbaar met handwiel.
- Aluminium parallelaanslag met excenterspanner.
- Krachtige motor 2,5kW voor zowel plaatmateriaal als hardhout geschikt.
- Grote centrale afzuigmond onderaan van ø 100 mm en bovenaan met een afzuigmond 38mm.
- Afscherming van het zaagblad

Geschikt voor:

- Beginners en de veeleisende doe-het-zelver
- Zowel zacht als hard hout.

Standaard geleverd met:

- Rolwagen met verlenging
- Klemslede
- Parallelaanslag
- Tafelverlenging met voetsupport
- Hardmetalen zaagblad ø 250 mm 36T

Order nr.		715900256	715900255
Orig. nr.		TKS250SC 230V	TKS250SC 400V
Spanning	V	1x230	400
Diameter zaagblad	mm	254	254
Maximum hoogte	mm	42/80	42/80
Maximum verstek zaagblad	°	0-45	45-90
Afmetingen werktafel (l x b)	mm	800x345	800x348
Werkhoogte	mm	895	895
Toerental	tpm	4000	4000
Vermogen motor	kW	2,5	2,5
Type motor		Elektro	Elektro
Maximum zaagbreedte met aanslag	mm	900	900
Diameter afzuiging	mm	38/100	38/100
Gewicht	kg	190,00	190,00
Afmetingen (l x b x h)	mm	950 x 760 x 1030	950 x 760 x 1030
Prijs	€	2.365,00	2.369,00

holzstar



Verplaatsbare sokkel TKS250SC.

Order nr.	715910258
Prijs	€ 84,50

holzstar



Hoekaanslag TKS250SC.

Order nr.	715910259
Prijs	€ 31,50

MACHINES



Robuuste formaatzaag met loopwagen.

Troeven:

- Robuuste formaatzaag met loopwagen
- Precieze, rolgelagerde loopwagens met telescopische armsteun, voor zaaglengtes tot 137 cm
- Zware gietijzeren tafel voor vibratiearm werken
- Hoekaanslag van -45 tot +45° zwenkbaar met lensvergroting voor precieze aflezing
- Zaagblad van 0 tot 45° neigbaar via draaiknop op tandlat
- Achteraanslag op loopwagens voor gemakkelijk doorvoeren van zware stukken
- Zaagblad in hoogte instelbaar met handwiel
- Tafelverlenging en verbreding meegeleverd
- Grote centrale afzuigmond ø 100mm
- Zaagbladbescherming met afzuigmond ø 38mm
- Aluminium parallelaanslag met fijninstelling
- Krachtige motor 3 kW
- 2 aparte noodstoppen

Geschikt voor:

- Zacht en hard hout
- Werkplaatsen, scholen en opleidingscentra

Standaard geleverd met:

- Loopwagens met arm
- Klemslede
- Parallelaanslag met fijnafstelling

Tip: wordt geleverd zonder zaagblad, vergeet deze niet bij te bestellen.

Order nr.	715900315	
Orig. nr.	FKS315-1500E	
Spanning	V	3x400
Diameter zaagblad	mm	315
Afmetingen werktafel (l x b)	mm	680 x 580
Toerental	tpm	4250
Vermogen motor	kW	3
Diameter afzuiging	mm	38/100
Maximum zaagbreedte met aanslag	mm	940
Maximum zaaghoogte	mm	100/75
Maximum lengte langszagen	mm	1370
Hoekinstelling zaagblad	°	0 - 45
Gewicht	kg	243,00
Prijs	€	2.355,00



4kW

• Ø315

• Met voorritser

Robuuste formaatzaag met voorritser.

TOT 200CM

Troeven:

- Robuuste formaatzaag met loopwagen
- Met voorritser, zorgt ervoor dat uw materiaal niet beschadigd wordt
- Precieze, rolgelagerde loopwagens met telescopische armsteun, voor zaaglengtes tot 200 cm
- Zware gietijzeren tafel voor vibratiearm werken
- Hoekaanslag van -45 tot +45° zwenkbaar met lensvergroting voor precieze aflezing
- Zaagblad van 0 tot 45° neigbaar via draaiknop op tandlat
- Achteraanslag op loopwagens voor gemakkelijk doorvoeren van zware stukken
- Zaagblad in hoogte instelbaar met handwiel
- Tafelverlenging en verbreding meegeleverd
- Tafelverlenging en verbreding voor zaagbreedtes tot 120 cm
- Grote centrale afzuigmond ø 100 mm
- Zaagbladbescherming met afzuigmond ø 38 mm
- Aluminium parallelaanslag met fijninstelling
- Krachtige motor 4 kW
- 2 aparte noodstoppen

Geschikt voor:

- Zacht en hard hout
- Werkplaatsen, scholen en opleidingscentra

Standaard geleverd met:

- Loopwagens met arm
- Voorritser
- Klemlede
- Parallelaanslag met fijnafstelling

Tip: wordt geleverd zonder zaagblad, vergeet deze niet bij te bestellen

Order nr.		715900317 
Orig. nr.		FKS315-2000E
Spanning	V	3x400
Diameter zaagblad	mm	315
Afmetingen werktafel (l x b)	mm	680 x 580
Toerental	tpm	4000
Vermogen motor	kW	4
Diameter afzuiging	mm	38/100
Maximum zaagbreedte met aanslag	mm	1220
Maximum zaaghoogte	mm	100/80
Diameter zaagblad voorritser	mm	90
Maximum lengte langszagen	mm	2000
Afmetingen loopwagens	mm	2000 x 270
Toerental voorritser	tpm	5800
Hoekinstelling zaagblad	°	0 - 45
Gewicht	kg	307,00
Prijs	€	3.069,00



Draagbaar en licht



Crosscut



Ripcut

Mobiele, compacte verticale paneelzaag met motor 1,8kW voor het zagen van alle soorten panelen. Zaaghoogte 1625mm. Gemakkelijk te installeren in 30 minuten. Perfect voor kleine werkruimtes en gebruik op werven. Met verlengstukken, lengteaanslag bij verticaal zagen en maataanduiding bij horizontaal zagen. Horizontaal zagen door de plaat te verschuiven, verticaal zagen door de motor te bewegen op geleidingsbuizen. Eenvoudig te bedienen door een persoon.

Opklapbare voet uit geplooid buizen en transportwielen, zeer licht. Deze verticale paneelzaag is geschikt voor het zagen van alle soorten panelen zoals OSB, Multiplex, composiet, massieve hout, PVC, plexi, Coroplast, Dibond, aluminium,... Onze verplaatsbare paneelzaag is ideaal voor goede knutselaars en kleine bedrijven die panelen moeten afsnijden zoals: bouwbedrijven, decoratiebedrijven, onderhoudswerkplaatsen, verpakkingsfabrikanten, fabrikanten van veranda's, houtbewerkers, enz.

Geleverd met:

- Universeel zaagblad voor hout \varnothing 185mm
- Robuust stalen frame uit gegalvaniseerd staal
- Voet, machine moet niet worden bevestigd aan de wand of grond
- Snelle omschakeling van verticaal naar horizontaal zagen
- Set verlengstukken (500mm aan elke zijde)
- Maataanduiding verticaal et horizontaal
- Stofkit voor aansluiting aan een stofzuiger aan de voorkant van de paneelzaag
- Motor 220V – 1,8kW

Order nr.	715001410	
Orig. nr.		PPRO5
Maximum zaaghoogte	mm	1625
Maximum zaaglengte	mm	2450
Maximum zaaghoogte horizontaal	mm	1625
Maximum zaagdikte	mm	45
Diameter zaagblad	mm	185-210
Spanning	V	220
Vermogen motor	kW	1,8
Zaagnauwkeurigheid	mm	1,0
Afmeting A (hoogte)	mm	2235
Afmeting B (lengte)	mm	1525
Afmeting C (diepte)	mm	900
Mobiel		✓
Verticaal zagen door verplaatsing van de motor		✓
Horizontaal zagen door verplaatsing van het paneel		✓
Aanslag verticaal zagen		✓
Maataanduiding bij horizontaal zagen		✓
Motor monofase		✓
Zaagrichting horizontaal		✓
Zaagrichting verticaal		✓
Gewicht	kg	51,00
Afmetingen (l x b x h)	mm	2235 x 1525 x 900
Prijs	€	2.575,00

Freemachines



• Hoekaanslag



Snelwisselen van snelheden



Freesaanslag met
fijninstelling



Naar achteren
zwenkbare spindel

Freemachine (toupie) met aluminium loopwagen en zwenkbare freesspindel.

Troeven:

- Aluminium loopwagen voor gemakkelijk doorvoeren van werkstukken
- Freesaanslag met fijn instelbare aluminium aanslagen
- Vlugge en eenvoudige snelheidsverandering dankzij de meervoudige V-riem / snaar
- Zware gietijzeren tafel met grote werkoppervlakte
- Gietijzeren freesas, zwenkbaar van +5° tot -45°
- Keuzeschakelaar voor het wijzer en tegenwijzerzin draaien van de freesspindel
- Freesspindel zwenkt naar achteren voor optimaal gebruik van het voedingsapparaat, maxmale veiligheid, en een nette gefreesde afwerking
- Neerhouder voor preciese en veilige werkstukgeleiding

Geschikt voor:

- het vervaardigen van kroonlijsten, lijstwerken, profielen, tegenprofielen in alle houtsoorten
- Voor de veeleisende doe-het-zelver, semi-professional, hersteller, ontwerper

Geleverd met:

- Hoekaanslag
- Neerhouder
- Frees afschermingskap
- Nederlandstalige handleiding

Tip: Telescopische support voor de tafel is optioneel verkrijgbaar 715912000.

Order nr.	715902000	
Orig. nr.		TF200SE
Spanning	V	3x400
Vermogen motor	kW	2.8
Diameter spindel	mm	30
Spindel neiging	°	5-45
Lengte spindel	mm	100
Werkhoogte	mm	900
Maximum diameter gereedschap	mm	180
Toerental	tpm	1800/3000/6000/9000
Afzuigmond	mm	100
Afmetingen loopwagen	mm	1000x240
Gewicht	kg	218,00
Prijs	€	2.715,00

Houtsplitters

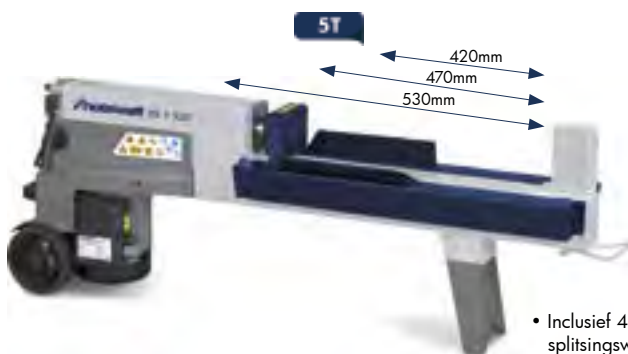

HS5

- Inclusief 4-weg splitsingswig



HS7-1000

Compacte houtsplitter.

Troeven:

- Gemakkelijk (met beide handen) te bedienen.
- Sneller werken door traploos instelbare 3 terugloopafstanden, en ingebouwde houtklem.
- Gelast splijtmes met maximale stabiliteit.
- Krachtige elektromotor.
- Gemakkelijk transporteerbaar
- Model HS7 met tussentafel voor variërende lengtes, en wielenset.
- Model HS5-520H: Horizontaal en verticaal bruikbaar.

Geschikt voor:

- Het splijten van lange en korte houten blokken.

Standaard geleverd met:

- 4-weg splitsingswig

Order nr.		715981105 ^{tr}	715981117 ^{tr}
Orig. nr.		HS5-520	HS7-1000
Spanning	V	230	230
Maximum splitkracht	T	5	7
Maximum splitslag	mm	320	480
Maximum splitslag	mm	320	480
Afmetingen tussentafel	mm		590-780-1040
Slag vooruitloop	cm/s	3	3
Slag terugloop	cm/s	8	8
Vermogen motor	kW	1,5	3
Gewicht	kg	50,00	115,00
Afmetingen (l x b x h)	mm	1200 x 260 x 485	830 x 930 x 1470
Prijs	€	349,00	885,00



Voet voor HS5-520H voor horizontaal gebruik van de splitten.

Order nr.		715991105 ^{tr}
Afmetingen (l x b x h)	mm	155 x 16 x 3
Prijs	€	57,50

holzkraft



5,2KW

MADE IN EUROPE

- Automatische terugkeerinrichting
- Inclusief zaagblad

Professionele brandhoutzaag.

Troeven:

- Stabiele en vlot scharnierende slede met aanslagdemping en hulpveer
- De gesloten zaagbladbescherming zorgt ervoor dat de machine stiller en stabiel is
- Speciale motorrem met ingebouwde sensor die de temperatuur op de motor meet
- Schakelaar/stekker combinatie met nullastspanning, zodat de machine niet automatisch opnieuw begint te werken na een stroomuitval
- Gemakkelijk te verplaatsen door de grote wielen en uitschuifbare handgrepen
- Krachtige elektromotor
- Hoogwaardige poederlak verflaag. Standaard geleverd met chroomstaal zaagblad
- De machine is voorzien van blokkeerbouten voor een veilige zaagbladwissel

Geschikt voor:

- Efficiënt verzagen van allerlei soorten brandhout

Standaard geleverd met:

- Chroomstaal zaagblad

Order nr.		71596051 [Ⓜ]	71596070 [Ⓜ]	71596073 [Ⓜ]
Orig. nr.		HWS550	HWSE700	HWS700
Spanning	V	230	3x400	3x400
Diameter zaagblad	mm	550	700	700
Werkhoogte	mm	960	960	840
Toerental	tpm	1550	1420	1450
Vermogen motor	kW	3	5,2	5,5
Type motor		Electro	elektro	Elektro
Capaciteit rondhout	mm	180	220	220
Snijsnelheid	m/sec	76	53	53
Gewicht	kg	80,00	97,00	120,00
Afmetingen (l x b x h)	mm	1100 x 660 x 1060	725 x 1050 x 1080	1330 x 730 x 1130
Prijs	€	955,00	1.079,00	1.389,00

holzkraft



Zaagbladen voor brandhout wipzagen HWS

Order nr.	Voor type	Tandsteek	Kwaliteit	Prijs
715970155 [Ⓜ]	HWS550	T	HM widia	150,00
715970055 [Ⓜ]	HWS550	36	HSS	92,50
715970070 [Ⓜ]	HWS700-HWSE700	56	HSS	115,00
715970170 [Ⓜ]	HWS700	42	HM widia	183,00

MACHINES

Stofzuigers en spaanderzuigers



ASA1051



ASA2403



ASA4003



ASA3303

Verplaatsbare afzuiger voor houten frees-, schaaf- en zaagspaanders.

Troeven:

- Stofafzuiging laat houtbewerkingsmachines beter presteren, en bezorgt u een gezonde werkomgeving
- Verplaatsbaar op wielen
- Uit staalplaat
- Ventilatorschroef uit metaal, in schoepenvorm voor een verhoogde zuigkracht
- Aanzuigmond en motor zijn 180° kantelbaar, zodat de machine ook kan worden aangesloten op buizen langsboven
- Gering stofgehalte door dubbel geweven filterzak cat G1
- Snelspanbevestiging voor filter- en spaanderzak

Geschikt voor:

- Houten frees-, schaaf- en zaagspaanders

Tip: Optionele fijnstoffilter beschikbaar.

Order nr.		715121051 ^M	715122401 ^M	715122403 ^M	715123303 ^M	715124003 ^M
Orig. nr.		ASA1051	ASA2401	ASA2403	ASA3303	ASA4003
Spanning	V	230	230	3x400	3x400	3x400
Maximum volumestroom	m ³ /h	1140	2464	2464	3540	3686
Maximum onderdruk	PA	680	1250	1250	2000	3100
Filteroppervlak	m ²	1,3	1,8	1,8	2x3,6	4,6/2x2,3
Filtercategorie		G1	G1	G1	G1	G1
Volume spaanderzak	l	100	160	160	2x160	2x270
Aansluiting slang	mm	100	100+120	100+120	100+2x120	100+3x120
Aansluiting aan toestel	mm	100	200	200	180	200
Vermogen motor	kW	0,75	1,1	1,1	1,5	2,2
Geluidsniveau	dB(A)	75	80	80	85	88
Gewicht	kg	36,00	43,50	43,50	57,50	79,50
Afmetingen (l x b x h)	mm	750 x 380 x 1850	900 x 480 x 2100	900 x 480 x 2100	1440 x 480 x 2200	1680 x 580 x 2800
Prijs	€	442,00	595,00	595,00	959,00	1.079,00



Aanloopschakelaar. Ideaal in combinatie met een stofafzuiger.

Voor het automatisch starten en stoppen van de stofafzuiger.

Order nr.	715121502 ^M
Spanning	V 2 x 230 - 400
Vermogen motor	kW 3.6
Prijs	€ 190,00



Automatische aanloopschakelaar. Ideaal in combinatie met een stofzuiger.

Deze schakelaar schakelt een tweede toestel automatisch in, bij het opstarten van een eerste toestel.

Order nr.	715121501 ^M
Spanning	V 230
Prijs	€ 80,90



Verplaatsbare afzuiger voor houten frees-, schaaaf- en zaagspaanders.

Troeven:

- Stofafzuiging laat houtbewerkingsmachines beter presteren, en bezorgt u een gezonde werkomgeving
- Verplaatsbaar op wielen
- Uit staalplaat
- Ventilatorschroef uit metaal, in schoepenvorm voor een verhoogde zuigkracht
- Aanzuigmond en motor zijn 180° kantelbaar, zodat de machine ook kan worden aangesloten op buizen langsboven
- Gering stofgehalte door dubbel geweven filterzak cat G1
- Snelspanbevestiging voor filter- en spaanderzak

Geschikt voor:

- Houten frees-, schaaaf- en zaagspaanders

Standaard geleverd met:

- 2 filterzakken 5 micron
- 4 PVC spanenzakken
- 1 spiraal afzuigslang

Tip: optionele fijnstoffilter beschikbaar.



Order nr.	715125403 ^M	
Orig. nr.	ASA5403	
Spanning	V	3x400
Maximum volumestroom	m ³ /h	5377
Maximum onderdruk	PA	4500
Filteroppervlak	m ²	6
Filtercategorie	G1	
Volume spaanderzak	l	2x450
Aansluiting slang	mm	100+3x120
Aansluiting aan toestel	mm	250
Vermogen motor	kW	3,7
Gewicht	kg	111,00
Afmetingen (l x b x h)	mm	1900 x 670 x 2800
Prijs	€	1.665,00

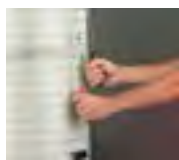

Accessoires voor industriële stofzuigers ASA. VE = verpakkingseenheid.

Order nr.	Omschrijving	VE	Min. bestelhoeveelheid	Prijs/VE €
715121052 ^M	filterzak ASA1051 - 970x580	1	1	39,90
715122054 ^M	fijnstoffilter ASA2401/2403/2051/2053/3053/5053 - 1170x660	1	1	48,90
715122554 ^M	filterzak ASA3303/2553	1	1	53,90
715123054 ^M	filterzak ASA4003/3053 - 1200x705	1	1	80,90
715125054 ^M	filterzak ASA5403/5053 - 1400x955	1	1	156,00
715121053 ^M	pvcspaanderzak ASA1051 - 970x600 (per st.)	1	10	3,00
715122055 ^M	pvcspaanderzak ASA2401/2403/2051/2053/2553/3303 - 650x1140x0,200 mm	1	10	2,90
715125055 ^M	spaanderzak ASA5403/5053 - 970x1350 mm	1	10	6,60
715123055 ^M	spaanderzak ASA4003/3053 - 810x1200x0,200 mm	1	10	3,50
715121054 ^M	filterpatroon ASA1051	1	1	252,00
715122056 ^M	fijnstoffilter ASA 2051/2053/2553/2401/2403/3303	1	1	442,00
715123056 ^M	fijnstoffilter ASA 3053/4003	1	1	492,00
715125056 ^M	fijnstoffilter ASA 5053/5403	1	1	492,00
715122005 ^M	verdeelstuk (ASA 2053/2553) 1x120 / 1x80 mm	1	1	33,90
715122006 ^M	verdeelstuk (ASA 2053/2553) 1x120 / 1x60 mm	1	1	33,90
715122007 ^M	verdeelstuk (ASA 4003/5403) 2x120 / 1x100 / 1x80 mm	1	1	50,50
715122008 ^M	verdeelstuk (ASA 4003/5403) 2x120 / 1x100 / 1x60 mm	1	1	50,50
715141212 ^M	spaanderzak RLA - 710x1240 mm	1	1	50,50
715142443 ^M	PU flexibele slang (1 meter) NW 100 mm	1	10	12,50
715142444 ^M	PU flexibele slang (1 meter) NW 120 mm	1	10	12,50

holzkraft



Intelligent luchtfiltersysteem voor ophanging in de werkplaats. Filtert stof en verontreinigingen uit de lucht.

Troeven:

- Overzichtelijk LED-display en bedieningspaneel
- Standaard met Elektrostatische filter die kleine deeltjes efficiënt en snel uifiltert
- Met afstandsbediening met timer voor automatische uitschakeling
- Automatische aanduiding van filterstatus beperkt vroegtijdige filterwissels
- Filtert deeltjes groter dan 1 µm uit de lucht
- 3 filtersnelheden afhankelijk van de gebruikintensiviteit
- Met 4 ophangbeugels

Voorbeeld: aangeraden verversingsgraad voor enkele ruimtes:

- Montagehal: 4-8x/u
- Labo: 8-15x/u
- Verfspuitlokaal: 25-50x/u

Order nr.		715127003
Orig. nr.		LFS3
Luchtdebiet	m ³ /u	846/1184/2030
Vermogen motor	W	150
Spanning	V	230
Gewicht	kg	23,00
Afmetingen (l x b x h)	mm	762 x 610 x 305
Prijs	€	539,00

holzkraft



Accessoires voor luchtfiltersysteem LFS3.

Order nr.		715127004	715127005
Orig. nr.		5127004	5127005
Omschrijving		prefilter	zakfilter
Prijs	€	16,50	39,90

Aanvoerapparaten



Aanvoerapparaat VSA32 0.18kW 400V voor houtbewerking.

Troeven:

- Gelijkmatige voedingssnelheid zonder krachtverlies
- Metaalaandrijving met geharde tandwielen
- Rechts-linksloop
- Krachtige motoren
- Statief met verlengde arm
- Individueel inzetbaar en zwenkbaar voor horizontaal en verticaal gebruik
- 3 aandrijfrollen
- 4 snelheden 5/6,5/8/11 m/min

Tip: we beschikken nog over tal van zwaardere uitvoeringen

Order nr.	715111000	
Orig. nr.	VSA32	
Aantal snelheden	4	
Aantal aandrijfrollen	3	
Spanning	V	3x400
Vermogen	W	180
Uitlading	mm	300
Diameter rol	mm	80
Rollengte	mm	30
Behuizing	metaal	
Gewicht	kg	34,00
Prijs	€	605,00



Aanvoerapparaat VSA 38EL 0.75kW 400V voor aan- en doorvoer van houten balken en planken.

Troeven:

- Gelijkmatige voedingssnelheid zonder krachtverlies
- Metaalaandrijving met geharde tandwielen
- Rechts-linksloop
- Krachtige motoren
- Statief met verlengde arm
- Individueel inzetbaar en zwenkbaar voor horizontaal en verticaal gebruik
- 3 aandrijfrollen
- 8 snelheden 2/4/5/6/10/12/15/30 m/min

Tip: we beschikken nog over tal van zwaardere uitvoeringen

Order nr.	715114501	
Orig. nr.	VSA38EL	
Aantal snelheden	8	
Aantal aandrijfrollen	3	
Spanning	V	3x400
Vermogen	W	750
Uitlading	mm	1050
Diameter rol	mm	120
Rollengte	mm	60
Behuizing	metaal	
Gewicht	kg	65,00
Prijs	€	969,00

0,18kW

4 SNELHEDEN



0,75kW

8 SNELHEDEN



Rollenbanen

holzkraft



Inklapbare en veelzijdige werktafel en rollenbaan met snelklemstelsysteem.

Troeven:

- Stabiele alu-stalen constructie.
- Gemaakt voor lange werkstukken.
- Wordt opgebouwd zonder werktuigen.
- Plaatsbesparend dankzij de inklapbare voeten.
- Werkstukhouders met snelklemming. In de hoogte verstelbare rollen.
- Aan beide zijden uitschuifbare oplegarmen tot max. 2400mm.
- 3 geïntegreerde 230V stekkerdozen langs de bedienerzijde
- Geïntegreerde opbergvak, voor het opbergen van bvb. sleutels, vijzen, etc.
- Max. belasting 225kg.

Geslacht voor:

- schuurmachines, afkortzagen, enz.

Order nr.	715900020
Orig. nr.	UWT3200
Minimum/maximum hoogte legvlak	mm 850-1000
Maximum breedte	mm 2400
Gewicht	kg 32,00
Afmetingen (l x b x h)	mm 1600 x 600 x 850
Prijs	€ 220,00

holzkraft



Klemset (2st) voor rollenbaan UWT3200. Lengte 500 mm.

Order nr.	715900022
Prijs	€ 34,90

holzkraft



Rollbokset (2st) voor rollenbaan UWT3200

Order nr.	715900025
Prijs	€ 25,90

holzkraft



Klem met geïntegreerde verlichting 230V stekker voor UWT3200.

Order nr.	715900023
Prijs	€ 26,90

holzkraft



Spanschroef met snelklemming voor UWT3200

Order nr.	715900024
Prijs	€ 42,90

holzstar



Samenplooibare materiaalsteun met rol.

Troeven:

- Traploos in hoogte verstelbaar met zware handgreep
- Samenplooibaar, gemakkelijk te transporteren
- Met stabiele verzinkte rol
- Draagkracht onderste positie 90 kg, midden 60 kg, hoogste positie 45 kg

Geslacht voor:

- Bandzagen, afkortzagen, en andere houtbewerkingsmachines

Order nr.	715900005
Orig. nr.	MS3R
Minimum/maximum hoogte legvlak	mm 670-1080
Capaciteit	kg 45-60-90
Maximum breedte	mm 285
Gewicht	kg 4,00
Afmetingen (l x b x h)	mm 430 x 500 x 1150
Prijs	€ 26,90

holzstar



Materiaalsteun met kogellagers.

Troeven:

- Traploos in hoogte verstelbaar
- Eenvoudig te transporteren
- Samenklapbaar

Order nr.	715900004
Orig. nr.	MSTK
Minimum/maximum hoogte legvlak	mm 700-1150
Capaciteit	kg 70
Maximum breedte	mm 450
Gewicht	kg 12,00
Afmetingen (l x b x h)	mm 135 x 500 x 810
Prijs	€ 65,90

holzstar



Schaar-rollebanen ook harmonica-rollebanen genoemd.

Troeven:

- Zeer robuute poten uit stalen kokers
- Volverzinkte rollen
- 360° draaibare kunststof wielen met rem
- Gemakkelijk koppelen van meerdere rollebanen met haaksysteem

Order nr.	715900012	
Orig. nr.	SRB130	
Minimum/maximum hoogte legvlak	mm	600-1000
Lengte rollebaan	mm	500-1400
Breedte rollebaan	mm	480
Statische draagkracht	kg	130
Gewicht	kg	36,00
Afmetingen (l x b x h)	mm	1480 x 670 x 970
Prijs	€	263,00

holzstar



Extreem robuuste zaagschraag.

Troeven:

- Stabiele stalen hoekprofielen
- Hoge roestbescherming door gegalvaniseerd bovenvlak
- Antislip oplegvlak
- Compact samenvouwbaar
- Gemakkelijk transporteerbaar

Order nr.	715900008	
Orig. nr.	SB1	
Minimum/maximum hoogte legvlak	mm	780
Capaciteit	kg	180
Gewicht	kg	7,60
Afmetingen (l x b x h)	mm	800 x 850 x 780
Prijs	€	33,90

holzstar



Opvouwbaar schraag.

Troeven:

- Gemakkelijk transporteerbaar.
- Laag in eigen gewicht en hoge draagkracht tot 200 kg
- Met kunststoffen draagbeugel.

Order nr.	715900006	
Orig. nr.	FAB1	
Minimum/maximum hoogte legvlak	mm	640-1030
Capaciteit	kg	200
Gewicht	kg	8,30
Afmetingen (l x b x h)	mm	970 x 620 x 1030
Prijs	€	38,50

holzstar



Stabiele materiaalsteun samenklaapbaar

Troeven:

- in hoogte instelbaar.
- UMS1 kan gebruikt worden als V rolsteun, als gewone rolsteun of als werksteun.

Order nr.	715900009	715900007
Orig. nr.	UMS1	TAB1300
Minimum/maximum hoogte legvlak	mm	820-1270
Capaciteit	kg	45-200
Gewicht	kg	10,40
Afmetingen (l x b x h)	mm	750 x 680 x 1270
Prijs	€	75,50

holzstar



Multifunctionele werktafel, instelbaar in hoogte en onder hoek

Troeven:

- onder hoek instelbaar 0°, 25°, 45° en 80°.
- Altijd een ergonomische positie zowel staand als zittend.
- Werkklem met 8 kunststof traploos instelbare spanbekken in verschillende profielvormen. Vele klemvormen mogelijk: vlak, rond, verticaal of horizontaal.
- Plaatsbesparend samenklaapbaar.
- Sterk werkoppervlak in staal en alu.
- Gelakte buisprofielen
- Onderstel met gummivoetjes.

Order nr.	715900010	
Orig. nr.	KWB100	
Minimum/maximum hoogte legvlak	mm	770-1070
Capaciteit	kg	100
Maximum breedte	mm	410
Lengte werkblad	mm	600
Gewicht	kg	13,70
Prijs	€	105,00

MACHINES

Generatoren

Unicraft

MACHINES



NEW

Robuuste stroomgenerator, voor universeel gebruik.

Zuinig en direct stroom opwekken.

Voordelen:

- Betrouwbare **Honda 4-takt** benzinemotor
- 230V spanning
- Licht in transport en snel inzetbaar
- Piekbelasting tot 3x het normaal vermogen
- Thermische overbelastingsschakelaar
- Oliepeilbewaking
- Made in EU

Geleverd met:

- 2 stekkers 230V
- Honda motor met handstart
- Standaardtank met 3,1 l inhoud
- IP44 beschermingsgraad

Order nr.		716700031
Orig. nr.		PG320SR
Spanning	V	230
Maximum vermogen	kVA	2.9
Continu vermogen	kVA	2.5
Start		manueel
Type motor		honda GX160 benzine 4-takt
Wikkelingen		koper
Benzine/olie tankinhoud	l	3,1
Autonomie (halve kracht)	u	3,44
Stopcontacten 230V	st	2
Geluidsniveau	dB(A)	96
Draagbaar		✓
Frequentie	Hz	50
Gewicht	kg	36,00
Afmetingen (l x b x h)	mm	640 x 458 x 400
Prijs	€	639,00



NEW

Benzine generator 2,8 kW op 230 V met 15 l tank.

Kenmerken:

- 2,8 kW maximaal, 2,5 kW continu vermogen op 230 V
- AVR automatische spanningsregeling: geeft steeds stabiele spanning af
- Piekvermogen van 7,5 kW voor opstart van motoren
- Zeer lange autonomie dankzij 15 l benzinetank
- Impactbestendig door buisframe en afschermplaten
- Gemakkelijk bereikbare stekkers en startkoord
- Thermische veiligheid tegen overload
- Automatisch uitschakelen bij olietekort

Geleverd met:

- Wielenset
- Inklapbare handgreep

Order nr.		716706030
Orig. nr.		PG-E30SRA
Spanning	V	230
Start		manueel
Energiebron		benzine
Tankinhoud	l	15
Maximum vermogen	kW	2,8
Continu vermogen	kW	2,5
Benzine/olie tankinhoud	l	15
Autonomie (halve kracht)	u	12,5
Stopcontacten 230V Schuko	st	2
Geluidsniveau	dB(A)	95
Beschermingsklasse generator	IP	23
Beschermingsklasse stekkers	IP	44
Gewicht	kg	45,00
Afmetingen (l x b x h)	mm	595 x 460 x 500
Prijs	€	432,00



NEW

Benzine generator 3,8 kW op 230 V met 15 l tank.

Kenmerken:

- 3,8 kW maximaal, 3,3 kW continu vermogen op 230 V
- AVR automatische spanningsregeling: geeft steeds stabiele spanning af
- Piekvermogen van 9,9 kW voor opstart van motoren
- Zeer lange autonomie dankzij 15 l benzinetank
- Impactbestendig door buisframe en afschermplaten
- Gemakkelijk bereikbare stekkers en startkoord
- Thermische veiligheid tegen overload
- Automatisch uitschakelen bij olietekort

Geleverd met:

- Wielenset
- Inklapbare handgreep

Order nr.		716706040
Orig. nr.		PG-E40SRA
Spanning	V	230
Start		manueel
Energiebron		benzine
Tankinhoud	l	15
Maximum vermogen	kW	3,8
Continu vermogen	kW	3,3
Autonomie (halve kracht)	u	14
Stopcontacten 230V Schuko	st	2
Geluidsniveau	dB(A)	95
Beschermingsklasse generator	IP	23
Beschermingsklasse stekkers	IP	44
Gewicht	kg	50,00
Afmetingen (l x b x h)	mm	595 x 460 x 527
Prijs	€	483,00

MACHINES



Benzine generator 5,5 kW op 230 V met 25 l tank.

NEW

Kenmerken:

- 5,5 kW maximaal, 5,0 kW continu vermogen op 230 V
- Elektrische start
- AVR automatische spanningsregeling: geeft steeds stabiele spanning af
- Piekvermogen van 15 kW voor opstart van motoren
- Zeer lange autonomie dankzij 25 l benzinetank
- Impactbestendig door buisframe en afschermplaten
- Gemakkelijk bereikbare stekkers en startkoord
- Thermische veiligheid tegen overload
- Automatisch uitschakelen bij olietekort

Geleverd met:

- Wielenset
- Inklapbare handgreep
- Elektrische start met sleutel

Order nr.		716706060 €
Orig. nr.		PG-E60SEA
Spanning	V	230
Start		elektrisch
Energiebron		benzine
Tankinhoud	l	25
Maximum vermogen	kW	5,5
Continu vermogen	kW	5,0
Autonomie (halve kracht)	u	16
Stopcontacten 230V Schuko	st	2
Stopcontacten 230V CEE 32A	st	1
Geluidsniveau	dB(A)	96
Beschermingsklasse generator	IP	23
Beschermingsklasse stekkers	IP	44
Gewicht	kg	81,00
Afmetingen (l x b x h)	mm	700 x 526 x 580
Prijs	€	839,00



Benzine generator 7,0 kW op **3x400 V** met 25 l tank.

NEW

Kenmerken:

- 7,0 kW maximaal, 6,5 kW continu vermogen op 3x400 V
- Elektrische start
- 3x400 V stopcontact en 2 stuks 230 V stekkerdozen
- AVR automatische spanningsregeling: geeft steeds stabiele spanning af
- Piekvermogen van 15 kW voor opstart van motoren
- Zeer lange autonomie dankzij 25 l benzinetank
- Impactbestendig door buisframe en afschermplaten
- Gemakkelijk bereikbare stekkers en startkoord
- Thermische veiligheid tegen overload
- Automatisch uitschakelen bij olietekort

Geleverd met:

- Wielenset
- Inklapbare handgreep
- Elektrische start met sleutel

Order nr.		716706080 €
Orig. nr.		PG-E80TEA
Spanning	V	3x400
Start		elektrisch
Energiebron		benzine
Tankinhoud	l	25
Maximum vermogen	kW	7,0
Continu vermogen	kW	6,5
Autonomie (halve kracht)	u	13
Stopcontacten 230V Schuko	st	2
Stopcontacten 400V CEE 16A	st	1
Geluidsniveau	dB(A)	96
Beschermingsklasse generator	IP	23
Beschermingsklasse stekkers	IP	44
Gewicht	kg	88,00
Afmetingen (l x b x h)	mm	700 x 526 x 580
Prijs	€	919,00

STANLEY



Benzinegenerator 230 en 3x400V op wielen

Kenmerken:

- Tot 5,5 kW
- 3 stekkers 230V mono
- 1 stekker 3x400V
- Elektrische start
- Grote ingebouwde benzinetank 25L die een grote autonomie waarborgt
- Automatische regeling en controle van het voltage
- Koperen windingen en luchtgekoelde motor
- Beveiliging tegen overbelasting en lage oliestand
- CE conform

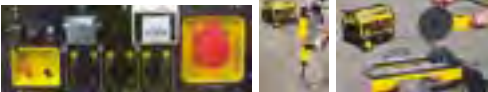

MACHINES

Order nr.	855085500 €	
Orig. nr.		SG5500
Spanning	V	230-400
Start		Elektrisch
Type motor		Benzine - 4-takt
Maximum vermogen	kW	5,5
Continu vermogen	kW	3,6
Wikkelingen		Koper
Maximum toerental	rpm	13/3600
Benzine/olie tankinhoud	l	25/1,1
Autonomie (halve kracht)	u	9,15
Stopcontacten 230V	st	3
Stopcontacten 3x400V	st	1
Geluidsniveau	dB(A)	97 (4m)
Op wielen		✓
Frequentie	Hz	50
Gewicht	kg	91,00
Afmetingen (l x b x h)	mm	730 x 590 x 595
Prijs	€	819,00

VERWARMINGSTOESTELLEN

Een warmeluchtblazer voor in uw werkplaats of op de werf? VYNCKIER houdt je warm! Bij ons vindt u elektrische verwarming en heaters op diesel of verwarmingstoestellen op gas. Deze werken met stralingswarmte of geventileerde warmte. Verwarmen, drogen en ontdooien in kleine en grote ruimtes, voor zowel binnen als buiten met de verwarmingstoestellen van Protemp, Stanley en Moel.

Verwarmen met elektriciteit, gas of diesel?

Elektrische verwarmingstoestellen produceren geen uitlaatgassen, geven geen geur of vocht af en hebben geen ventilatie of zuurstof nodig. Daarom zijn ze zeer geschikt voor indoor werkomgevingen en kleine ateliers. Elektrische verwarming garandeert ook continue autonomie. Warmteblazers op gas of diesel hebben een hele grote capaciteit, en kunnen gemakkelijk grote ruimtes verwarmen. Ideaal dus voor grote tenten, bedrijfshallen en events waar veel mensen zijn.

PROTEMP



STANLEY



PROTEMP[®]
Sun-Stream

21KW

Elektrische modellen

MO77



INSTANT HEAT



Elektrisch infrarood verwarmingstoestel met aangename warmtestraling.

Voordelen:

- Door de gerichte reflectie van de warmte, gaat er minder energie verloren dan bij traditionele verwarmingstoestellen.
- Infrarood-straling verwarmt personen en objecten direct, zonder de omgevende atmosfeer te beïnvloeden: **een direct en krachtig resultaat**, zelfs bij wind.
- Deze heaters produceren geen uitlaatgassen, zodat ze bijzonder geschikt zijn voor indoor werkomgevingen.
- Geen behoefte aan ventilatie.

Kenmerken:

- Geschikt voor binnen- en buitentoepassingen of bij regenval.
- Water- en stofbestendig (IP65).
- Verstevigde stroomkabel voor toepassing op werven of in constructie-omgevingen (H07RNF).
- De hoogwaardige infraroodlampen hebben een gemiddelde levensduur van 5000 uren. Modellen met 1200 of 1760Watt.

Geleverd met ketting voor plafondophanging.

Optionele muurbevestiging.

Order nr.	722316345 €	722316350 €
Orig. nr.	MO766C	MO767C
Warmte type	stralingswarmte IR-A	stralingswarmte IR-A
Totaal verbruik	W 1200	1760
Verwarmbare ruimte	m ³ 4-6	8-10
Spanning	V 230	230
Type lampen	wit	wit
Levensduur	u 5000	5000
Kabel	H07RN-F	H07RN-F
Isolatieklasse	I	I
Beschermingsklasse	IP 65	65
Geschikt voor buitengebruik	✓	✓
Stralingsfrequentie	korte golf	korte golf
Gewicht	kg 0,95	1,00
Afmetingen (l x b x h)	mm 712 x 112 x 83	835 x 112 x 83
Prijs	€ 122,00	128,00

MO77

2x1760W



Dubbele elektrische infraroodstraler met aangename warmtestraling.

Voordelen:

- Door de gerichte reflectie van de warmte, gaat er minder energie verloren dan bij traditionele verwarmingstoestellen.
- Infrarood-straling verwarmt personen en objecten direct, zonder de omgevende atmosfeer te beïnvloeden: **een direct en krachtig resultaat**, zelfs bij wind.
- Deze heaters produceren geen uitlaatgassen, zodat ze bijzonder geschikt zijn voor indoor werkomgevingen.
- Geen behoefte aan ventilatie.

Kenmerken:

- Geschikt voor binnen- en buitentoepassingen of bij regenval.
- Water- en stofbestendig (IP65).
- Verstevigde stroomkabel voor toepassing op werven of in constructie-omgevingen (H07RNF).
- De hoogwaardige infraroodlampen hebben een gemiddelde levensduur van 5000 uren. Modellen met 1200 of 1760Watt.

Geleverd met telescopische voet. Hiermee verwarmt u een grotere werkplaats, zonder een extra hinderende voet te plaatsen.

Order nr.	722316352 €	
Orig. nr.	MO767SET	
Warmte type	stralingswarmte IR-A	
Totaal verbruik	W	2x1760
Verwarmbare ruimte	m ³	16-20
Spanning	V	230
Type lampen	wit	
Levensduur	u	5000
Kabel	H07RN-F	
Isolatieklasse	I	
Beschermingsklasse	IP	65
Geschikt voor buitengebruik	✓	
Stralingsfrequentie	korte golf	
Gewicht	kg	12,00
Afmetingen (l x b x h)	mm	835 x 300 x 2000
Prijs	€	367,00



Elektrisch infrarood verwarmingstoestel met krachtige 4000W output.

Voordelen:

- Door de gerichte reflectie van de warmte, gaat er minder energie verloren dan bij traditionele verwarmingstoestellen.
- Infrarood-straling verwarmt personen en objecten direct, zonder de omgevende atmosfeer te beïnvloeden: **een direct en krachtig resultaat**, zelfs bij wind.
- Deze heaters produceren geen uitlaatgassen, zodat ze bijzonder geschikt zijn voor werkomgevingen.

Kenmerken:

- Industriële elektrische infraroodheater met goudgele lamp 4000Watt.
- Gerichte hittestaling.
- Aluminium behuizing, geschikt voor binnentoepassingen zoals productielijnen of drooginstallaties in de carrosserie.
- Geschikt voor muur- en plafondophanging.
- De hoogwaardige infraroodlampen hebben een gemiddelde levensduur van 5000 uren.

Zonder kabel en stroomstekker.

Order nr.	722316360	
Orig. nr.	MO792	
Warmte type	stralingswarmte IR-A	
Totaal verbruik	W	4000
Verwarmbare ruimte	m	12-16
Spanning	V	230
Type lampen	goud	
Levensduur	u	5000
Kabel	x	
Stralingsfrequentie	korte golf	
Muurbevestiging	✓	
Gewicht	kg	2,40
Afmetingen (l x b x h)	mm	235 x 486 x 313
Prijs	€	308,00



Muuradapter voor elektrische infrarood verwarmingstoestel 767C van MOEL.

Order nr.	722316365	
Orig. nr.	768M	
Omschrijving	muuradapter	
Voor type	MO766C/MO767C	
Gewicht	kg	10,00
Prijs	€	14,50



Voet voor elektrische infrarood verwarmingstoestel 767C van MOEL.

Order nr.	722316366	
Orig. nr.	002473	
Omschrijving	voet	
Voor type	MO766C/MO767C	
Gewicht	kg	10,00
Prijs	€	56,90



Voetadapter voor elektrische infrarood verwarmingstoestel 767C van MOEL.

Order nr.	722316367	
Orig. nr.	768P	
Omschrijving	voetadapter	
Voor type	MO766C/MO767C	
Gewicht	kg	0,50
Prijs	€	30,50

MACHINES

MO771

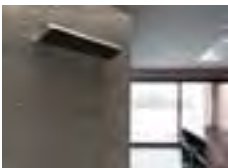

NEW

NO LIGHT, ONLY HEAT

INFRARED BLACKLIGHT

Blacklight infrarood warmestraler. Een nieuwe ervaring in infrarood verwarming. Zachte en aangename warmte, zonder het storende gele licht van klassieke infraroodlampen.

Voordelen:

- **Geen lichtoutput:** ideaal voor kantoren, eet- en wachzalen, publieke ruimtes
- **Zowel binnen als buiten: IP65 waterbestendig**
- Gelijkmatische warmteverspreiding: ideaal voor langdurig verwarmen
- Modern en discreet design in geanodiseerd aluminium
- Geen geluids- en geurhinder
- De hoogwaardige infraroodlampen hebben een gemiddelde levensduur van 5000 uren
- Modellen met 1800 of 3200 Watt
- Geleverd met muurbeugel
- Optionele beugels voor het koppelen van meerdere units

Kenmerken infrarood verwarming:

- Door de gerichte reflectie van de warmte, gaat er minder energie verloren dan bij traditionele verwarmingstoestellen
- Infrarood-straling verwarmt personen en objecten direct, zonder de omgevende atmosfeer te beïnvloeden: een direct en krachtig resultaat, zelfs bij wind
- Deze heaters produceren geen uitlaatgassen, zodat ze bijzonder geschikt zijn voor indoor werkomgeving
- Geen behoefte aan ventilatie

Order nr.	722316363 €	722316390 €
Orig. nr.	MO7718	MO7732
Warmte type	stralingswarmte	stralingswarmte
Totaal verbruik	W 1800	3200
Verwarmbare ruimte	m ³ 9	12
Spanning	V 220-240	220-240
Kabel	HO5SSF 3 m	HO5SSF 3 m
Isolatieklasse	I	I
Beschermingsklasse	IP 65	65
Geschikt voor buitengebruik	✓	✓
Muurbevestiging	✓	✓
Gewicht	kg 6,55	11,10
Afmetingen (l x b x h)	mm 1172 x 176 x 45	1872 x 176 x 194
Prijs	€ 318,00	380,00

MO771

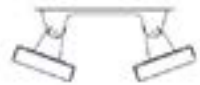

Beugel dubbel breedte voor verwarmingstoestellen MO7718 en MO7732.

Order nr.	722316385 €
Orig. nr.	MO7701
Prijs	€ 46,50

MO771

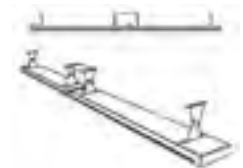

Beugel dubbele lengte voor verwarmingstoestellen MO7718 en MO7732.

Order nr.	722316386 €
Orig. nr.	MO7702
Prijs	€ 28,50

MO771



Achterbeugel voor verwarmingstoestellen MO7718 en MO7732.

Order nr.	722316387 €
Orig. nr.	MO7703
Prijs	€ 25,50

STANLEY



Klein elektrisch verwarmingstoestel voor werkplaatsen, bureaucontainers.

Kenmerken:

- Vermogen 2 kW.
- Temperatuurregeling door thermostaat
- 3 ventilatiesnelheden.

Geschikt voor:

- Kleine ruimtes tot 20m³.
- ook voor het buitenhouden van vorst in grotere ruimtes

Order nr.	722316240 €
Orig. nr.	ST-602 WS E
Afgegeven warmte	kW/h 2
Thermostaat	✓
Verwarmbare ruimte	m ³ 15-20
Spanning	V 230
Gewicht	kg 2,30
Prijs	€ 44,90

STANLEY

PLAATS-BESPAREND



Elektrische warmeluchtblazer 3kW voor compacte ruimtes

Voordelen:

- Met ophangbeugel voor plafond en muur, hangt steeds uit de weg
- Met infrarood afstandsbediening
- 2 warmtestanden
- met timer

Order nr.	722316227 €	
Orig. nr.	ST403R-231E	
Afgegeven warmte	kW/h	3
Warmte type	geventileerde lucht	
Thermostaat	✓	
Verwarmbare ruimte	m ³	20-30
Spanning	V	230
Gewicht	kg	5,60
Afmetingen (l x b x h)	mm	300 x 300 x 450
Prijs	€	96,90

VENTILEREN+VERWARMEN

MET THERMOSTAAT



Elektrische warmeluchtblazer.

Kenmerken:

- Geschikt voor het verwarmen van werkplaatsen, werven, ...
- Verbruikt geen zuurstof en geeft geen vocht of geur af.
- Meerstanden-schakelaar voor ventilator, en thermostaat.
- Thermisch beveiligd en geluidsarm
- Aansluiting op 230V
- Beveiligingsklasse IPX4, CE gekeurd

Geleverd met kabel en stekker

Order nr.	722316200 €	
Orig. nr.	PT02230	
Afgegeven warmte	kW/h	2
Thermostaat	✓	
Verwarmbare ruimte	m ³	15-20
Spanning	V	230
Gewicht	kg	4,80
Afmetingen (l x b x h)	mm	237 x 250 x 355
Prijs	€	56,90

Unicraft

Infraroodstraler voor het drogen van lakwerken in carrosserie.

Kenmerken:

- Hoogwaardige VPower 50 cm infraroodlampen
- Kortegolf Quartz- halogeenlampen
- Steeds optimaal positioneren van de lampen, dankzij stabiele constructie met luchtpiston
- Droogt lak van buiten naar binnen
- Blazen worden vermeden, met tijds winst als gevolg
- Volautomatische digitale instelling van de warmte-output (LED)
- Elektronische temperatuurregeling van 40 tot 100 °C
- Stralers elk apart inschakelbaar en hoek instelbaar van 0 tot 300°
- 2 droogsystemen:
 - PULSE: voordrogen/verdampen
 - ROUTINE: continuëdrogen/uitdruigen
- Rogelagerde wielen met rem



Order nr.	716205000 €	
Orig. nr.	ILT3W	
Vermogen	W	3x1100
Spanning	V	230
Frequentie	Hz	50
Droogoppervlak	mm	1200x1000
Temperatuur	°C	40-100
Tijdsinterval	min	0-99
Prijs	€	799,00

STANLEY



Elektrische warmeluchtblazer met ventilator, geschikt voor het verwarmen van kleine werkplaatsen of kantoren.

Kenmerken:

- Verbruikt geen zuurstof en geeft geen vocht of geur af.
- Meerstanden-schakelaar voor ventilator, en thermostaat.
- Thermisch beveiligd.
- Geluidsarm.
- Aansluiting op 3x400V.
- Beveiligingsklasse IPX4.
- CE gekeurd.

Geleverd zonder kabel en stekker.

Order nr.	722316216 €	
Orig. nr.	ST09-400	
Afgegeven warmte	kW/h	9
Thermostaat	✓	
Verwarmbare ruimte	m ³	60-90
Spanning	V	3x400
Gewicht	kg	10,30
Afmetingen (l x b x h)	mm	465 x 400 x 540
Prijs	€	194,00

MACHINES

Dieselmodellen



THE ORIGINAL
MET THERMOSTAAT



MACHINES

Infrarood - warmeluchtblazer; op petroleum of diesel met een comfortabele stralingswarmte.

Kenmerken:

- De gepatenteerde infraroodverbranding garandeert een totale en reukarme verbranding.
- Beperkte stofafzetting en een zeer geruisloze werking.
- Brandstof: diesel en witte petroleum.
- Zowel binnen als buiten perfect inzetbaar voor het verwarmen, drogen en ontdooien van geventileerde ruimtes
- Ideaal voor gebruik op bouwerven.
- Eenvoudig verplaatsbaar dankzij zijn laag gewicht en handvat.
- Bescherming tegen oververhitting dankzij de ingebouwde fotocelvlambewaking.
- Roestvrijstalen behuizing van de stralingskamer en -elementen.
- Ingebouwde tank met brandstofniveaumeter -aan/af schakelaar, met thermostaat.
- Veiligheden: vlambewaking, oververhittingssensor en hoeksensor zorgen voor optimale veiligheid.
- CE gekeurd.

Order nr.	722315070 	
Orig. nr.	PT-70-SS-EU	
Afgegeven warmte	kW/h	20,509
Warmte type	stralingswarmte	
Energiebron	petroleum/diesel	
Thermostaat	✓	
Capaciteit brandstoftank	l	13,2
Brandstofverbruik	l/u	1,4
Spanning	V	230
Verwarmbare ruimte	m ²	385
Autonomie	h	7
Frequentie	Hz	50
Gewicht	kg	13,40
Afmetingen (l x b x h)	mm	530 x 550 x 370
Prijs	€	499,00

STRALINGSWARMTE VS GEVENTILEERDE WARMTE

Infraroodverwarming geeft stralingswarmte af. De meeste verwarmingstoestellen werken echter met warmeluchtverwarming, en dan gaat het om geventileerde warmte.

Stralingswarmte (= infraroodwarmte)

- Gerichte hittestraling zorgt voor een direct, krachtig en aangenaam resultaat
- Geen ventilatie noodzakelijk
- Ideaal voor binnen én buiten

Geventileerde warmte (= warmeluchtstroom)

- Dankzij de ventilatie wordt de warmte sneller verspreid
- Voor het verwarmen van grotere ruimtes
- Ideaal voor binnen én buiten

Producten

2 STANDEN



Infrarood - warmeluchtblazer; op diesel met een comfortabele stralingswarmte.

Kenmerken:

- De gepatenteerde infraroodverbranding garandeert een totale en reukarme verbranding.
- Beperkte stofafzetting en een zeer geruisloze werking.
- Brandstof: diesel en witte petroleum.
- Zowel binnen als buiten perfect inzetbaar voor het verwarmen, drogen en ontdoien van geventileerde ruimtes
- Ideaal voor gebruik op bouwerven.
- Mobiel dankzij 2 stevige rubber wielen.
- Bescherming tegen oververhitting dankzij de ingebouwde fotocelvlambewaking.
- Roestvrijstalen behuizing van de stralingskamer en -elementen.
- Ingebouwde tank met brandstofniveaumeter -aan/af schakelaar, met thermostaat.
- Veiligheden: vlambewaking, oververhittingssensor en hoeksensor zorgen voor optimale veiligheid.
- CE gekeurd.

Order nr.		722315125 €
Orig. nr.		PT-125-OFR-EU
Afgegeven warmte	kW/h	36,600
Warmte type		stralingswarmte
Energiebron		petroleum/diesel
Capaciteit brandstoftank	l	47,3
Brandstofverbruik	l/u	2,6/3,6
Spanning	V	230
Verwarmbare ruimte	m ³	702
Autonomie	h	17/13
Frequentie	Hz	50
Gewicht	kg	44,00
Afmetingen (l x b x h)	mm	721 x 706 x 980
Prijs	€	1.425,00

MET THERMOSTAAT



PT70T-KFA-EU



PT125T-KFA-EU

VOOR GROTE RUIMTES



PT175KFAE



PT215T-KFA-EU



Warmeluchtblazers op diesel met ventilator. Verwarmt snel en direct elke ruimte.

Kenmerken:

- Brandstof: diesel en witte petroleum.
- Directe verbranding.
- Zowel binnen als buiten perfect inzetbaar voor het verwarmen, drogen en ontdooien van geventileerde ruimtes.
- Ideaal voor gebruik op bouwerven.
- Zeer mobiel dankzij 2 stevige rubber wielen (behalve PT70T-KFA-EU).
- Met thermostaatbediening.
- Aan/af schakelaar.
- Met drukmeter en digitale thermometer.
- Ingebouwde tank met brandstofniveaumeter.
- CE gekeurd.

Order nr.		722314070 €	722314125 €	722314175 €	722314215 €
Orig. nr.		PT 70T-KFA-EU	PT 125T-KFA-EU	PT-175KFAE	PT 215T-KFA-EU
Afgegeven warmte	kW/h	20.496	36.600	51.250	62.994
Warmte type		geventileerde lucht	geventileerde lucht	geventileerde lucht	geventileerde lucht
Energiebron		petroleum/diesel	petroleum/diesel	petroleum/diesel	petroleum/diesel
Thermostaat		✓	✓	✓	✓
Capaciteit brandstoftank	l	19	38	49	49
Brandstofverbruik	l/u	2	3,60	5,10	6,17
Verwarmbare ruimte	m ³	385	702	974	1200
luchtverplaatsing	cm ³ /h	407,8	917,5	1070,4	1138,3
Spanning	V	230	230	230	230
Frequentie	Hz	50	50	50	50
Geluidsniveau	dB(A)	84	88	88	90
Gewicht	kg	12,70	23,00	26,30	27,70
Afmetingen (l x b x h)	mm	356 x 432 x 812	457 x 510 x 965	457 x 510 x 1092	457 x 510 x 1092
Prijs	€	380,00	569,00	609,00	649,00

PROTEMP



GELUIDSARM

INNOVATION



Warmeluchtblazers op diesel met DUAL FUSION technologie.

Unieke voordelen:

- **Geluidsarm:** slechts 80 dB
- **Regelbare warmte-output:** lager verbruik en rustiger verbranden
- Hoogwaardige brandstofpomp: onderhoudsarm
- Digitaal display en bediening
- Perfecte Koud weer opstart

Andere kenmerken:

- Grote tank = tot 11h autonomie
- Grote verwarmingscapaciteit, Ideaal voor grote tenten, bedrijfshallen, events.
- Complete verbranding: minder rook en geurhinder
- Directe opstart, ook in zeer koud weer en met koude brandstof
- Thermostaat en digitaal display met temperatuur aanduiding en urenteller
- volle wielen, kunnen niet leklopen.
- Bescherming tegen oververhitting en vlambewaking

Order nr.		722314130	722314135
Orig. nr.		PT 150T-DFV	PT 220T-DFV
Afgegeven warmte	kW/h	35/44	50-65
Warmte type		geventileerde lucht	geventileerde lucht
Energiebron		petroleum/diesel	petroleum/diesel
Thermostaat		✓	✓
Capaciteit brandstoftank	l	37,85	49,21
Brandstofverbruik	l/u	3,4/4,3	4,9-6,3
Verwarmbare ruimte	m ²	667-834	945-1223
Spanning	V	230	230
Frequentie	Hz	50	50
Geluidsniveau	dB(A)	80	82
Gewicht	kg	27,00	57,00
Afmetingen (l x b x h)	mm	457 x 510 x 965	457 x 510 x 965
Prijs	€	609,00	709,00



VOOR AFGESLOTEN RUIMTES

Warmeluchtblazers op diesel met aparte rookgasafvoer.

Unieke voordelen:

- **Warmtewisselaar** brengt enkel de hitte in de ruimte, niet de rook en roet
- Inox verbrandingskamer met lange levensduur
- Zeer grote tank en autonomie.
- Heater kan buiten staan, en met optionele slang warmte naar binnen blazen.

Toepassing:

- Ideaal voor grote ruimtes met veel mensen, vb. tenten, bedrijfshallen, ...
- Aparte rookgasafvoer bovenaan

Kenmerken:

- Brandstof: diesel en witte petroleum.
- Directe verbranding.
- Zowel binnen als buiten perfect inzetbaar voor het verwarmen, drogen en ontdooien van geventileerde ruimtes.
- Zeer mobiel dankzij 2 stevige rubber wielen (behalve PT70T-KFA-EU).
- Met thermostaatbediening.
- Aan/af schakelaar.
- Met drukmeter en digitale thermometer.
- Ingebouwde tank met brandstofniveau-meter.
- CE gekeurd.

Order nr.		722314140 €	722314145 €
Orig. nr.		PT 100-IDF	PT 170-IDF
Afgegeven warmte	kW/h	30	50
Energiebron		petroleum/diesel	petroleum/diesel
Thermostaat		✓	✓
Capaciteit brandstoftank	l	50	68
Brandstofverbruik	l/u	2,4	4
Verwarmbare ruimte	m ³	575	950
Spanning	V	230	230
Geschikt voor buitengebruik		✓	✓
Frequentie	Hz	50	50
Geluidsniveau	dB(A)	80	80
Gewicht	kg	32,00	65,00
Afmetingen (l x b x h)	mm	457 x 510 x 965	457 x 510 x 965
Prijs	€	1.085,00	1.235,00



Hittebestendige slang + klem voor warmeluchtblazers type IDF

Order nr.		722314142 €	722314147 €
Orig. nr.		PT100IDF-SL	PT170IDF-SL
Diameter	mm	230	350
Werktemperatuur	°C	300	300
Lengte	m	3	3
Gewicht	kg	8,00	8,00
Prijs	€	75,50	97,90

Gasmodellen

STANLEY



Infrarood verwarmingstoestel op propaangas.

Kenmerken:

- werkt volledig op gas, zonder elektrische stroom.
- Infrarood verwarming geeft comfortabele warmte zonder luchtstroom.
- Piezo ontsteking
- 3 hoogwaardige keramische platen.
- 3 posities (1,4-2,75-4,1kW).
- Heel lange autonomie
- Wielen met rem
- Voorzien van een CO₂- en omvalbeveiliging.

Geleverd met:

- Gasregelaar
- Slang

Order nr.		722316300 €
Orig. nr.		ST14A-CH
Energiebron		propaangas
Brandstofverbruik	l/u	1,135
Spanning	V	230
Gewicht	kg	11,00
Prijs	€	143,00



PT150V-GFA-E



Gasontspanner type POL



Gasontspanner type SHELL



Warmeluchtblazers op propaangas uitgerust met een ingebouwde elektrische ventilator.

Kenmerken:

- Zowel binnen als buiten perfect inzetbaar voor het verwarmen, drogen en ontdooien van geventileerde ruimtes.
- Ideaal voor gebruik op bouwerven of grote loodsen
- Eenvoudig verplaatsbaar.
- Draaiknop met 3 temperaturniveaus, niet thermostatisch.
- Bescherming tegen oververhitting.
- Elektronische ontsteking van de vlam.
- Beveiliging schakelt gas uit in geval van stroompanne.
- CE gekeurd.

Geleverd met:

- POL of SHELL ontspanner voor gasflessen met binnendraad of buitendraad.
- Gaslang.

Order nr.	722316150 €	722316153 €
Orig. nr.	PT 150V-GFA-E POL	PT 150V-GFA-E SH
Afgegeven warmte	kW/h 43,950	43,950
Energiebron	propaangas	propaangas
Brandstofverbruik	l/u 3	3
Verwarmbare ruimte	m ³ 345	345
Spanning	V 230	230
Aansluiting ontspanner	POL	SHELL
Gewicht	kg 8,00	8,00
Afmetingen (l x b x h)	mm 637 x 226 x 403	637 x 226 x 403
Prijs	€ 252,00	252,00



Gasontspanner type POL



Gasontspanner type SHELL

Warmeluchtblazers op propaangas met ingebouwde elektrische ventilator.

Kenmerken:

- Zowel binnen als buiten perfect inzetbaar voor het verwarmen, drogen en ontdooien van geventileerde ruimtes.
- Ideaal voor gebruik op bouwerven, loodsen, ...
- Licht en draagbaar
- Draaiknop met 3 temperaturniveaus
- Bescherming tegen oververhitting.
- Elektronische ontsteking van de vlam.
- Beveiliging schakelt gas uit in geval van stroompanne.
- CE gekeurd.

Geleverd met:

- POL of SHELL ontspanner voor gasflessen met binnendraad of buitendraad.
- Gaslang.

Order nr.	722316062 €	722316064 €
Orig. nr.	PT-15KW-G POL	PT-15KW-G SHEL
Afgegeven warmte	kW/h 14,649	14,649
Brandstofftype	propaangas	propaangas
Brandstofverbruik	kg/u 1,11	1,11
Luchtdebiet	m ³ /u 300	
Verwarmbare ruimte	m ³ 116	116
Spanning	V 230	230
Aansluiting ontspanner	POL	SHELL
Instelbare hoek van de warmte	✓	✓
Gewicht	kg 4,60	4,60
Prijs	€ 164,00	164,00

Een goede ventilatie is de basis voor een gezonde werkomgeving. Stof, rook, dampen of gevaarlijke gassen (CO) kunnen best worden afgevoerd met een ventilator met afvoerslang. Ventilatoren kunnen ook de toevoer van verse lucht in kelders of containers voorzien, indien daar een problematisch gebrek aan is. Tenslotte behoort ook drogen en koelen van machines of mensen tot de mogelijkheden. Ook kan er met de vaste ventilatoren kan 's nachts frisse lucht naar binnen worden gebracht. In warme bedrijfsgebouwen of op evenementen mogen de grote axiaalventilatoren of windmakers dus niet ontbreken.

Ventilatoren

MACH



LICHT EN COMPACT

Mobiele ventilator. 250W.

Compacte en draagbare ventilator.
Zeer laag geluidsniveau.

Uiterst geschikt voor:

- Drogen, verluchten, afkoelen, toevoeren of afvoeren van lucht
- Verwijderen van rook, lasrook, gassen, geuren, slijpstof
- Toevoeren van verse lucht in zuurstofarme werkruimtes zoals kelders, containers
- Geschikt voor gebruik op 60 Hz

Geleverd met:

- Dubbel afschermrooster
- Thermische beveiliging
- rubber pootjes

Optie:

- flexibele slang 10 meter

Order nr.	722313490 €	
Orig. nr.		MV200
Vermogen	W	250
Totale druk	pa	250
Isolatiegraad		F
Diameter	mm	200
Spanning	V	230
Debiet	m ³ /min	20
Snelheid	tpm	2800
Werktemperatuur	°C	-20 - +80
Geluidsniveau	dB(A)	69
Behuizing		Staal
Ventilatorblad		Aluminium
IP		20
Gewicht	kg	7,00
Afmetingen (l x b x h)	mm	325 x 245 x 320
Prijs	€	85,00

MACH

LICHT EN COMPACT



Mobiele ventilator. 500W.

Compacte en draagbare ventilator.

Uiterst geschikt voor:

- Drogen, verluchten, afkoelen, toevoeren of afvoeren van lucht
- Verwijderen van rook, lasrook, gassen, geuren, slijpstof
- Toevoeren van verse lucht in zuurstofarme werkruimtes zoals kelders, containers
- Geschikt voor gebruik op 60 Hz

Geleverd met:

- Dubbel afschermrooster
- Thermische beveiliging
- rubber pootjes

Optie:

- flexibele slang 10 meter
- Filterzak geschikt voor verwijderen van kwartsstof op werven
- Draagzak voor flexibele slangen

Order nr.	722313500 €	
Orig. nr.		MV300
Vermogen	W	500
Totale druk	pa	290
Isolatiegraad		F
Diameter	mm	300
Spanning	V	230
Debiet	m ³ /min	72
Snelheid	tpm	2800
Werktemperatuur	°C	-20 - +80
Geluidsniveau	dB(A)	69
Behuizing		Staal
Ventilatorblad		Aluminium
IP		20
Gewicht	kg	11,00
Afmetingen (l x b x h)	mm	380 x 375 x 360
Prijs	€	123,00



Afvoeren



Toevoeren

ACCESSOIRES VENTILATOREN

p.728



MACH

HOOG DEBIET EN WINDDRUK

ONDBREEKBAAR



Mobiele ventilator in polyethyleen. 750W.

Troeven:

- Heel licht en draagbaar
- Hoog debiet en druk
- Roest niet, behuizing en blad zijn volledig in kunststof

Geschikt voor:

- Drogen, verluchten, afkoelen, toevoeren of afvoeren van lucht
- Verwijderen van rook, lasrook, gassen, geuren, slijpstof
- Toevoeren van verse lucht in zuurstofarme werkruimtes zoals kelders, schepen, containers
- Geschikt voor gebruik op 60 Hz

Geleverd met:

- Dubbel afschermrooster
- Thermische beveiliging

Optie:

- Flexibele slangen 10m. koppelbaar tot 30m
- Slangen koppelbaar aan toevoer en afvoerszijde
- Filterzak geschikt voor stof en kwartsstof

Order nr.	722313504 €	
Orig. nr.		MV300PP
Vermogen	W	750
Totale druk	pa	418
Isolatiegraad		F
Diameter	mm	300
Spanning	V	230
Debiet	m ³ /min	56
Werktemperatuur	°C	-20 · +80
Geluidsniveau	dB(A)	78
Snelheid	tpm	
Behuizing		PE
Ventilatorblad		Kunststof
IP		20
Gewicht	kg	14,00
Afmetingen (l x b x h)	mm	520 x 390 x 490
Prijs	€	179,00

MACH



Vonkvrije ventilator met aandrijving op druklucht.

Troeven:

- Draagbaar en zeer compact
- Vonkvrij, want werkt zonder elektroschakelaar of motor
- Met drukschakelaar en vochtafscheider op de ventilator
- Drukregelaar op de unit regelt draaisnelheid en debiet

Geleverd met:

- Dubbel afschermrooster
- Aardingsaansluiting op de behuizing
- Hoogwaardige drukschakelaar, -regelaar en vochtafscheider

Geschikt voor:

- Afzuiging van schadelijke en ontlambare dampen in machinekamers, petro-chemie, scheepvaart, ...
- Drogen, verluchten, afkoelen, toevoeren of afvoeren van lucht
- Verwijderen van gassen, geuren, dampen, stof
- Toevoeren van verse lucht in zuurstofarme werkruimtes zoals kelders, schepen, containers

Optie:

- antistatische slangen 10 m

Order nr.	722313545 €	
Orig. nr.		PV300
Totale druk	pa	230
Isolatiegraad		F
Diameter	mm	300
Debiet	m ³ /min	58
Snelheid	tpm	2800
Werktemperatuur	°C	-20 · +80
Geluidsniveau	dB(A)	85
Behuizing		staal
Ventilatorblad		aluminium
Gewicht	kg	12,00
Afmetingen (l x b x h)	mm	459 x 385 x 520
Prijs	€	485,00

MACHINES

MACH

HOOG DEBIET EN WINDDRUK

TOEVOEREN EN AFVOEREN

OP WIELEN



Mobiele ventilatoren. 1100W.

Voordelen

- Blaasrichting instelbaar
- Stevig buisframe met wielen
- Zeer hoog debiet
- volledig in metaal

Uiterst geschikt voor:

- Drogen, verluchten, afkoelen, toevoeren of afvoeren van lucht
- Verwijderen van rook, lasrook, gassen, geuren, slijpstof
- Toevoeren van verse lucht in zuurstofarme werkruimtes zoals kelders, schepen, containers
- Geschikt voor gebruik op 60 Hz

Geleverd met:

- Dubbel afschermrooster
- Thermische beveiliging
- 4 wielen, waarvan 2 draaibaar en met rem

Optie:

- Flexibele afvoerslang 10 meter, koppelbaar tot 30m
- Filterzak geschikt voor verwijderen van stof en kwartsstof

Order nr.	722313505 E	
Orig. nr.	MV500R	
Vermogen	W	1100
Totale druk	pa	180
Isolatiegraad	F	F
Diameter	mm	500
Spanning	V	230
Debiet	m ³ /min	218
Snelheid	tpm	1450
Werktemperatuur	°C	-20 - +80
Geluidsniveau	dB(A)	72
Behuizing		Staal
Ventilatorblad		Aluminium
IP		20
Gewicht	kg	27,00
Afmetingen (l x b x h)	mm	480 x 580 x 755
Prijs	€	319,00

MACH

HOOG DEBIET EN WINDDRUK

TOEVOEREN EN AFVOEREN

OP WIELEN



Mobiele ventilator. 2000W.

Uiterst geschikt voor:

- Drogen, verluchten, afkoelen, toevoeren of afvoeren van lucht
- Verwijderen van rook, lasrook, gassen, geuren, slijpstof
- Toevoeren van verse lucht in zuurstofarme werkruimtes zoals kelders, schepen, containers
- Geschikt voor gebruik op 60 Hz

Troeven:

- Hoog debiet
- Laag geluidsniveau.
- Dubbel afschermrooster
- Thermische beveiliging

Optie:

- Diverse slangen
- Filterzak geschikt voor verwijderen van kwartsstof op werven
- De blaashoek is instelbaar op het mobiele frame.
- Geleverd op wielen voor vlotte verplaatsing.

Order nr.	722313510 E	
Orig. nr.	MV600R	
Vermogen	W	2000
Totale druk	pa	480
Isolatiegraad	F	F
Diameter	mm	600
Spanning	V	230
Debiet	m ³ /min	240
Snelheid	tpm	1450
Werktemperatuur	°C	-20 - +80
Geluidsniveau	dB(A)	77
Behuizing		Staal
Ventilatorblad		Aluminium
IP		20
Gewicht	kg	67,00
Afmetingen (l x b x h)	mm	580 x 680 x 870
Prijs	€	535,00

MACH

OPTIONELE VOET

Multifunctionele ventilator met 2 snelheden. 200W.

De ideale droogventilator na waterwerken, reinigingswerken of bij waterschade.

Troeven:

- Grote blaashoek, droogt grote delen van de ruimte in 1x zonder verplaatsing
- blaasrichting instelbaar (kantelbaar op optionele voet)
- 2 snelheden, steeds de optimale luchtdebiet
- Schokbestendige behuizing in polyetheen van hoge dichtheid
- volledig in kunststof, roest nooit

Toepassingen:

- Bruikbaar met optionele aan-/afvoerslangen van 10 meter
- Tot 3 units stapelbaar
- Tot 2 achter elkaar koppelbaar met standaard meegeleverde buigels

Geschikt voor:

- Drogen van natte ruimten op heel korte tijd (kantoor, school, openbaar gebouw)
- Op bouwerven (beton, pleisterwerken, ...)
- Sneller droger, samen met bouwdrogers.
- Luchtcirculatie en verluchten van zuurstofarme ruimten
- Afvoer van gassen en slechte geurtjes

Order nr.	722313540 €	
Orig. nr.	MV500PP	
Vermogen	W	200
Totale druk	pa	300
Isolatiegraad	F	
Diameter	mm	500
Spanning	V	230
Debiet	m ³ /min	110
Snelheid	tpm	1450
Werktemperatuur	°C	-20 - +80
Geluidsniveau	dB(A)	72
Behuizing	PE	
Ventilatorblad	PE	
IP	20	
Gewicht	kg	17,50
Afmetingen (l x b x h)	mm	550 x 365 x 575
Prijs	€	219,00

MACH
OP WIELEN

Grote ventilator op wielen, traagdraaiend. 265W.

Troeven:

- De blaashoek is instelbaar op het mobiele frame
- 3 snelheden, steeds de optimale luchthoeveelheid
- Traag toerental en uiterst laag geluidsniveau
- Geleverd op wielen voor vlotte verplaatsing
- Groot bereik dankzij grote diameter

Geschikt voor:

- Luchtcirculatie en verluchten van zuurstofarme ruimten
- Drogen van natte ruimten of op bouwerven (beton, pleisterwerken, ...)
- Koelen van apparaten, motoren en oppervlakken
- Special effects in film en fotografie

Order nr.	722313530 €	
Orig. nr.	MV600L	
Vermogen	W	265
Isolatiegraad	F	
Diameter	mm	600
Spanning	V	230
Debiet	m ³ /min	72
Snelheid	tpm	1250
Werktemperatuur	°C	-20 - +80
Geluidsniveau	dB(A)	72
Behuizing	Staal	
Ventilatorblad	Aluminium	
IP	20	
Gewicht	kg	17,00
Afmetingen (l x b x h)	mm	760 x 300 x 785
Prijs	€	179,00

MACHINES



Afvoeren

Toevoeren

Flexibele slang 10m voor ventilatoren

- Voor toevoeren en afvoeren
- Lengte 10 m, kan probleemloos gekoppeld worden tot 30 meter.
- Onbrandbaar nylon, verstevigd met stalen spiraal.

Order nr.		722313491 €	722313501 €	722313506 €	722313511 €
Orig. nr.		MV200SL	MV300SL	MV500SL	MV600SL
Diameter	mm	200	300	500	600
Werktemperatuur	°C	-30 - +80	-30 - +80	-30 - +80	-30 - +80
Lengte	m	10	10	10	10
Voor type	°C	MV200	MV300	MV500R	MV600R
Gewicht	kg	8,00	8,00	10,00	20,00
Prijs	€	68,50	89,00	148,00	172,00



UITWASBAAR

Filterzak voor ventilatoren met aansluiting ø 300 mm en 500 mm.

- Ideaal voor het gebruik op werven
- Ontworpen voor het opvangen van schadelijk stof en kwartsstof uit bouw- en afbraakwerken.
- Verbeterd aanzienlijk de arbeidsomstandigheden tijdens het slijpen, frezen, stralen, kappen, schuren, ...
- Uitwasbaar, en dus herbruikbaar

Order nr.		722313502 €	722313507 €
Orig. nr.		MV300FZ	MV500FZ
Diameter	mm	300	500
Lengte	m	3	3
Filtercategorie		F8	F8
Efficiëntie	%	90-95 (EN779 0.3µm)	90-95 (EN779 0.3µm)
Gewicht	kg	2,90	2,90
Prijs	€	39,00	68,50



PVC opbergzak voor kunststof slangen voor ventilatoren.

Voordelen:

- Slangen altijd compact weggeborgen
- Geen moeite meer met volumineuze, uitgerolde slangen

Beschikbaar voor \varnothing 200 mm en \varnothing 300 mm slangen.

Order nr.	722313548	722313549
Orig. nr.	MV200SB	MV300SB
Voor type	MV200SL	MV300SL
Gewicht	0,50 kg	0,50 kg
Afmetingen (l x b x h)	200 x 200 x 1 mm	300 x 300 x 1 mm
Prijs	€ 12,50	€ 14,50



Antistatische slang van 10 meter voor gebruik op de pneumatische ventilator PV300.

Order nr.	722313546
Orig. nr.	PV300SL
Lengte	10 m
Gewicht	12,00 kg
Afmetingen (l x b x h)	459 x 385 x 520 mm
Prijs	€ 149,00



Aluminium voet voor multifunctionele ventilator MV500PP.

Laat toe om de ventilator in alle richtingen te positioneren.
Laat toe om plafonds te drogen na waterschade of schilder- of pleisterwerken.

Order nr.	722313541
Orig. nr.	MV500PPV
Gewicht	2,00 kg
Prijs	€ 43,90

MACH



Set bestaande uit mobiele ventilator MV300 + afvoerslang MV300SL + filterzak MV300FZ.

MV300

- Mobiele ventilator 500 W
- Drogen, verluchten, afkoelen, toevoeren of afvoeren van lucht
- Verwijderen van rook, lasrook, gassen, geuren, slijpstof
- Toevoeren van verse lucht in zuurstofarme werkruimtes zoals kelders, schepen, containers
- Geschikt voor gebruik op 60 Hz
- Hoog debiet
- Laag geluidsniveau
- Dubbel afschermrooster
- Thermische beveiliging

MV300SL

- Toe- of afvoerslang 10 m voor mobiele ventilatoren.
- Flexibel en onbrandbaar nylon, ook geschikt bij slijp- of laswerken.
- Meerdere slangen kunnen na elkaar gekoppeld worden

MV300FZ

- Filterzak voor ventilatoren met aansluiting \varnothing 300 mm.
- Ontworpen voor het opvangen van schadelijk stof en kwartsstof uit bouw- en afbraakwerken.
- Verbeterd aanzienlijk de arbeidsomstandigheden tijdens het slijpen, frezen, stralen, kappen, schuren, ...
- Uitwasbaar, en dus herbruikbaar

Order nr.	722313503	
Orig. nr.	MV300SET	
Vermogen	W	500
Totale druk	pa	385
Isolatiegraad	F	
Diameter	mm	300
Spanning	V	230
Debiet	m ³ /min	56
Snelheid	tpm	2800
Werktemperatuur	°C	-20 · +80
Geluidsniveau	dB(A)	69
Behuizing	staal	
Ventilatorblad	aluminium	
Gewicht	kg	22,00
Prijs	€	236,00

MACH



Set bestaande uit mobiele ventilator MV300PP + afvoerslang MV300SL + filterzak MV300FZ.

MV300PP

- Mobiele ventilator 750W
- Drogen, verluchten, afkoelen, toevoeren of afvoeren van lucht
- Verwijderen van rook, lasrook, gassen, geuren, slijpstof
- Toevoeren van verse lucht in zuurstofarme werkruimtes zoals kelders, schepen, containers
- geschikt voor gebruik op 60 Hz
- Hoog debiet

MV300SL

- Toe- of afvoerslang 10 m voor mobiele ventilatoren.
- Flexibel en onbrandbaar nylon, ook geschikt bij slijp- of laswerken.
- Meerdere slangen kunnen na elkaar gekoppeld worden

MV300FZ

- Filterzak voor ventilatoren met aansluiting \varnothing 300 mm.
- Ontworpen voor het opvangen van schadelijk stof en kwartsstof uit bouw- en afbraakwerken.
- Verbeterd aanzienlijk de arbeidsomstandigheden tijdens het slijpen, frezen, stralen, kappen, schuren, ...
- Uitwasbaar, en dus herbruikbaar

Order nr.	722313509	
Orig. nr.	MV300PPSET	
Vermogen	W	750
Totale druk	pa	418
Isolatiegraad	F	
Diameter	mm	300
Spanning	V	230
Debiet	m ³ /min	56
Snelheid	tpm	2750
Werktemperatuur	°C	-20 · +80
Behuizing	PE	
Ventilatorblad	kunststof	
IP	20	
Gewicht	kg	25,00
Prijs	€	290,00



Set bestaande uit mobiele ventilator MV500R + slang MV500SL + filterzak MV500FZ.

MV500R

- Mobiele ventilator 1100 W
- Drogen, verluchten, afkoelen, toevoeren of afvoeren van lucht
- Verwijderen van rook, lasrook, gassen, geuren, slijpstof
- Toevoeren van verse lucht in zuurstofarme werkruimtes zoals kelders, schepen, containers
- Geschikt voor gebruik op 60 Hz

MV500SL

- Toe- en afvoerslang 10 m voor mobiele ventilatoren
- Flexibel en onbrandbaar nylon, ook geschikt bij slijp- of laswerken
- Meerdere slangen kunnen na elkaar gekoppeld worden

MV500FZ

- Filterzak voor ventilatoren met aansluiting 500 mm
- Ontworpen voor het opvangen van schadelijk stof en kwartsstof uit bouw- en afbraakwerken
- Verbetert aanzienlijk de arbeidsomstandigheden tijdens het slijpen, frezen, stralen, kappen, schuren, ...
- Uitwasbaar, en dus herbruikbaar

Order nr.	722313508	
Orig. nr.	MV500RSET	
Vermogen	W	1100
Totale druk	pa	400
Isolatiegraad		F
Diameter	mm	500
Spanning	V	230
Debiet	m ³ /min	130
Snelheid	tpm	1400
Werktemperatuur	°C	-20 - +80
Geluidsniveau	dB(A)	72
Behuizing		staal
Ventilatorblad		aluminium
IP		20
Gewicht	kg	35,00
Prijs	€	499,00

BATTERIJLADERS

TELWIN is een gecertificeerd bedrijf volgens de normen ISO 9001:2008 en BSI OHSAS 18001:2007. Telwin betekent betrouwbaarheid en degelijkheid. Onze prestaties zijn gecertificeerd door de belangrijkste internationale instellingen (TÜV, GOST, UL, CSA, enz.). Telwin staat ook voor onderzoek, ontwikkeling en technologische innovatie. Onze machines moeten niet alleen streven naar hoge prestaties, maar ook naar lager energieverbruik en RoHs conforme grondstoffen/onderdelen, in het kader van duurzame ontwikkeling. Telwin gaat voor innovatie voor ieders voordeel.





TELWIN: TECHNOLOGIE, INNOVATIE EN VEILIGHEID VOOR EEN BETERE WERELD



CERTIFIED QUALITY SYSTEM
UNI EN ISO 9001:2008



CERTIFIED SYSTEM
OHSAS 18001:2007



Types of Batteries

GB WET Batteries: Lead-Antimony (PbSn) or Lead-Calcium (PbCa) or Lead Calcium-Silver (PbCaAg) batteries with liquid electrolyte made up of water (H2O) and sulphoric acid (H2SO4). These are the most widely used batteries in the automotive sector.

F Batteries WET: Batteries au plomb-antimoine (PbSn) ou plomb-calcium (PbCa) ou plomb-calcium-argent (PbCaAg) avec électrolyte liquide constitué d'une solution d'eau (H2O) et d'acide sulfurique (H2SO4). Ces batteries sont les plus courantes dans le secteur automobile.

GB GEL Batteries: Lead-Calcium batteries (PbCa) with solid gelatinous electrolyte. Given that these batteries are completely sealed, they can be positioned in different applications without running the risk of having the electrolyte leaking. Maintenance free.

F Batteries GEL: Batteries au Plomb-Calcium (PbCa) à électrolyte solide de type gélatineux, complètement hermétiques et qui peuvent être employées par conséquent dans différentes positions sans risque de fuite de l'électrolyte. Ces batteries demandent pas d'entretien.

GB AGM Batteries: These are solid (starved) electrolyte lead-calcium (PbCa) batteries in which the fibreglass plates absorb and hold the entire acid content. They are completely sealed and can therefore be used in a variety of positions with no risk of electrolyte leaks. Maintenance-free.

F Batteries AGM: Batteries au plomb-calcium (PbCa) à électrolyte solide dont les éléments en laine de verre absorbent et conservent tout l'acide contenu. Entièrement scellées, les batteries peuvent être utilisées en toutes positions sans risque de fuite de l'électrolyte. Aucun entretien nécessaire.

PulseTronic Characteristics

PulseTronic

F Contrôle automatique des étapes de charge

- Maintien de la charge par impulsions "PulseTronic"
- amélioration du contrôle du maintien de la charge
- protection du système électronique de bord
- charge de batteries très déchargées
- protection totale sans étincelles pour inversion polarité et courts-circuits
- réduction du temps de chauffage de la batterie durant la charge (réduction des oscillations)
- durabilité accrue des batteries.

GB Automatic control of step charging process

- Pulse charging maintenance "PulseTronic"
- greater control for holding the charge
- protection of on-board electronics
- charges very flat batteries
- total, spark-free, reverse polarity and short circuit control
- reduced heat production in battery during charging (fewer fluctuations)
- batteries last longer.

PulseTronic Models



Serial connection - Последовательное Соединение

GB Charge voltage = Sum of each voltage in V • Batteries need to have the same capacity in Ah

RU Напряжение заряда = Сумма отдельных напряжений • Аккумуляторы должны иметь одинаковую емкость в Ампер-час

Parallel connection - Параллельное Соединение

GB Charge capacity = Sum of each capacity in Ah • Batteries need to have the same voltage in V

RU Напряжение заряда = Сумма отдельных емкостей • Аккумуляторы должны иметь одинаковое напряжение

1
12V + 12V = 24V
70 Ah 70 Ah 70 Ah

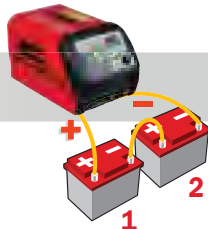

1 2
40 Ah + 35 Ah = 75 Ah
12V 12V 12V

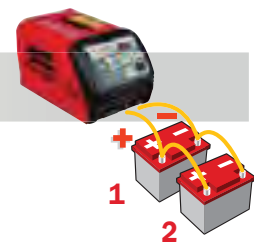

Battery Charger Status



BATTERY CAPACITY	Recommended Charge Current					
	WET		GEL/AGM		Ni - Cd	
Ah	Normal	Rapid	Normal	Rapid	Normal	Rapid
20	2 A	10 A	5 A	10 A	2A	10A
60	5 A	20 A	5 A	20 A	5A	20A
100	10 A	40 A	20 A	40 A	10A	30A
150	10 A	40 A	30 A	40 A	10A	40A
200	20 A	40 A	40 A	40 A	20A	40A



Elektronische batterijladers en starters



Intelligente elektronische batterijlader.

Kenmerken:

- laden en druppelladen.
- geschikt voor alle soorten batterijen (GEL/WET/AGM/START-STOP).
- Spanning van 12V voor moto's, auto's en bestelwagens.
- automatische continue controle van de laadstroom
- Geleverd met klemmen en ringen, uitwisselbaar

De PULSE-TRONIC technologie : Elektronische sturing voor een langere levensduur van de batterijen door o.a. constante laad-controle en optimalisatie, gereduceerde laadtemperatuur, bescherming van boordinstrumenten en laden van bijna lege batterijen. IP54. Spatwaterdicht.

Order nr.	830807553	
Orig. nr.	DEFENDER 8	
Spanning	V	100-240
laadspanning	V	6-12
laadstroom	A	0.75
Referentiecapaciteit	Ah 15h (min/max)	2/30
Geschikt voor loodbatterij		✓
Geschikt voor gel/AGM batterij		✓
Geschikt voor Ni-Cd batterij		✓
Gewicht	kg	0,20
Prijs	€	24,50



Intelligente elektronische batterijladers.

Kenmerken:

- Continue controle van de laadstroom en druppelladen.
- Ontworpen voor het laden van alle soorten batterijen (GEL/WET/AGM/START-STOP).
- Spanning van 12V voor moto's, auto's en bestelwagens.
- Geleverd met klemmen, ringen en stekker voor sigarettenaanstekers.

De PULSE-TRONIC technologie : Elektronische sturing voor een langere levensduur van de batterijen door o.a. constante laad-controle en optimalisatie, gereduceerde laadtemperatuur, bescherming van boordinstrumenten en laden van bijna lege batterijen. IP54. Spatwaterdicht.

Order nr.	830807559	
Orig. nr.	T-CHARGE10	
Spanning	V	230
Laadspanning	V	12
Laadstroom	A	2
Referentiecapaciteit	Ah 15h (min/max)	5/50
Opgenomen vermogen	kW	0,04
Geschikt voor loodbatterij		✓
Geschikt voor gel/AGM batterij		✓
Geschikt voor Ni-Cd batterij		✓
Gewicht	kg	0,36
Afmetingen (l x b x h)	mm	135 x 65 x 48
Prijs	€	37,90



Intelligente elektronische batterijladers.

Kenmerken:

- Continue controle van de laadstroom en druppelladen.
- Ontworpen voor het laden van alle soorten batterijen (GEL/WET/AGM/START-STOP).
- Spanning van 12 V voor moto's, auto's en bestelwagens.
- Geleverd met 3 types van kabels 830802997, 830802989, 830802998.

De PULSE-TRONIC technologie : Elektronische sturing voor een langere levensduur van de batterijen door o.a. constante laadcontrole en optimalisatie, gereduceerde laadtemperatuur, bescherming van boordinstrumenten en laden van bijna lege batterijen. IP54. Spatwaterdicht.

Order nr.	830807560	
Orig. nr.	T-CHARGE12	
Spanning	V	230
Laadspanning	V	12
Laadstroom	A	4
Referentiecapaciteit	Ah 15h (min/max)	2/70
Opgenomen vermogen	kW	0,055
Geschikt voor loodbatterij		✓
Geschikt voor gel/AGM batterij		✓
Geschikt voor Ni-Cd batterij		✓
Gewicht	kg	0,60
Afmetingen (l x b x h)	mm	170 x 65 x 35
Prijs	€	63,50



T-Charge 12 lithium edition.

Intelligente elektronische batterijladers voor het laden van 12 V LITHIUM en vele andere types batterijen.

Kenmerken:

- Continue controle van de laadstroom en druppelladen
- Ontworpen voor het laden van alle soorten batterijen (LITHIUM/GEL/WET/AGM/START-STOP)
- Spanning van 12 V voor moto's, auto's en bestelwagens
- Geleverd met 3 types van kabels 830802997, 830802989, 830802998

De PULSE-TRONIC technologie : Elektronische sturing voor een langere levensduur van de batterijen door o.a. constante laadcontrole en optimalisatie, gereduceerde laadtemperatuur, bescherming van boordinstrumenten en laden van bijna lege batterijen. IP54. Spatwaterdicht.

Order nr.	830807564	
Orig. nr.	T-CHARGE12LE	
Spanning	V	230
Laadspanning	V	12
Laadstroom	A	4
Referentiecapaciteit	Ah 15h (min/max)	2/70
Opgenomen vermogen	kW	0,055
Geschikt voor loodbatterij		✓
Geschikt voor gel/AGM batterij		✓
Geschikt voor Ni-Cd batterij		✓
Gewicht	kg	0,60
Prijs	€	74,50



Intelligente elektronische batterijladers.

Kenmerken:

- Continue controle van de laadstroom en druppelladen.
- Ontworpen voor het laden van alle soorten batterijen (GEL/WET/AGM/START-STOP).
- Spanning van 12/24V voor moto's, auto's en bestelwagens.
- Met batterij-indicator tijdens het laden. Bescherming tegen kortsluiting van de uitgaande kabels of verkeerde polariteit.
- Geleverd met klemmen en ringen.

De PULSE-TRONIC technologie : Elektronische sturing voor een langere levensduur van de batterijen door o.a. constante laad-controle en optimalisatie, gereduceerde laadtemperatuur, bescherming van boordinstrumenten en laden van bijna lege batterijen. IP54. Spatwaterdicht.

Order nr.	830807563 €	
Orig. nr.	T-CHARGE20BOOST	
Spanning	V	230
Laadspanning	V	12/24
Laadstroom	A	8
Referentiecapaciteit	Ah 15h (min/max)	5/180
Opgenomen vermogen	kW	0,11
Geschikt voor loodbatterij		✓
Geschikt voor gel/AGM batterij		✓
Geschikt voor Ni-Cd batterij		✓
Gewicht	kg	1,28
Afmetingen (l x b x h)	mm	300 x 95 x 55
Prijs	€	97,00



Intelligente elektronische batterijladers.

Kenmerken:

- Continue controle van de laadstroom en druppelladen.
- Ontworpen voor het laden van alle soorten batterijen (GEL/WET/AGM/START-STOP).
- Spanning van 12V voor moto's, auto's en bestelwagens.
- Geleverd met klemmen en ringen.

De PULSE-TRONIC technologie : Elektronische sturing voor een langere levensduur van de batterijen door o.a. constante laad-controle en optimalisatie, gereduceerde laadtemperatuur, bescherming van boordinstrumenten en laden van bijna lege batterijen. IP54. Spatwaterdicht.

Order nr.	830807562 €	
Orig. nr.	T-CHARGE26BOOST	
Spanning	V	230
Laadspanning	V	12
Laadstroom	A	16
Referentiecapaciteit	Ah 15h (min/max)	10/250
Opgenomen vermogen	kW	0,22
Geschikt voor loodbatterij		✓
Geschikt voor gel/AGM batterij		✓
Geschikt voor Ni-Cd batterij		✓
Gewicht	kg	1,38
Afmetingen (l x b x h)	mm	300 x 95 x 55
Prijs	€	131,00



NEW



JUMP STARTER PERFORMANCE	
Drive 5000	Drive 6000
12V START	12V START
600A	800A
350A OUT	450A OUT
60Ah	60Ah
+4h	+5h

Lithium booster en backup batterij.

Hoogperformantie lithiumbatterij.

Geschikt voor:

- Opladen van mobiele apparaten (smart phones, laptop, ...)
- Starten van voertuigen (12 V) dankzij hoge boostcapaciteit van de lithium batterij.
- ondanks kleine batterij toch enorm krachtige boosterbatterij voor gebruik onderweg.

Kenmerken:

- 2 USB poorten
- 2 LED lichten
- Opberghoes
- Startkabels met omkeerbeveiliging
- Set stekkers en adapters, startklemmen voor autobatterij, 12 V autolader
- Lithium batterij behoudt lading heel lang zonder bijladen
- zeer compact en licht

Order nr.	830829565 €	830829566 €
Orig. nr.	DRIVE 9000	DRIVE 13000
Capaciteit batterij	Ah 9	13
Spanning	V 240	240
Laadspanning	V 12	12
Startstroom	Max. A cc 600	800
Output 12V	A 10	10
Output 19V	A 3,5	3,5
USB (1)	A 2,1	2,1
USB (2)	A 2,1	2,1
Gewicht	kg 0,40	0,50
Afmetingen (l x b x h)	mm 175 x 75 x 30	175 x 75 x 30
Prijs	€ 149,00	174,00



NEW



Solar druppellader voor mobiele apparaten en voertuigen.

Handig backup stroombron voor onderweg. De panelen leveren 12 V output, en zijn geleverd met 12 V autoconnector, klemmen en connectiekabels.

Order nr.	830807583 €
Orig. nr.	SOLARA 1.5
Uitgangsspanning	V 12
Uitgangsstroom	A 0,1
Maximaal vermogen	W 1,5
Gewicht	kg 0,48
Afmetingen (l x b x h)	mm 350 x 125 x 13
Prijs	€ 29,50



NEW



Solar druppellader voor mobiele apparaten en voertuigen.

Handig backup stroombron voor onderweg. 12 V output. Geleverd met 12 V autoconnector, klemmen, connectiekabels en USB kabel.

Order nr.	830807584 €
Orig. nr.	SOLARA 5.0
Uitgangsspanning	V 12
Uitgangsstroom	A 0,3
Maximaal vermogen	W 5
Gewicht	kg 1,00
Afmetingen (l x b x h)	mm 365 x 345 x 15
Prijs	€ 63,50



NEW



Solar druppellader voor mobiele apparaten en voertuigen.

Handig backup stroombron voor onderweg. De panelen leveren 12 V output, en zijn geleverd met 12 V autoconnector, klemmen, connectiekabels en USB kabel.

Order nr.	830807582 €
Orig. nr.	SOLARA 10.0
Uitgangsspanning	V 12
Uitgangsstroom	A 0,6
USB (1)	A 0,5
Maximaal vermogen	W 10
Gewicht	kg 1,00
Afmetingen (l x b x h)	mm 725 x 185 x 25
Prijs	€ 113,00



Lader en druppellader 12V en 24V (model 200), geschikt voor alle types batterijen (GEL, AGM, START-STOP, SPIRAL).

Kenmerken:

- Met LED laadniveau indicator en ampèremeter.
- Lichte starthulp 50 of 100 A.

Order nr.		830807576 €	830807577 €
Orig. nr.		ALASKA 150	ALASKA 200
Spanning	V	230	230
Laadspanning	V	12	12/24
Laadstroom	A	10	15
Opgenomen vermogen	kW	0,18	0,6-3
Starter		✓	✓
Startstroom	Max. A cc	50-100	100/150
Uitgangsstroom	A	15	
Referentiecapaciteit	Ah (15h min/max)	10/200	25/300
Gewicht	kg	5,00	7,00
Afmetingen (l x b x h)	mm	200 x 250 x 130	200 x 250 x 130
Prijs	€	93,90	129,00



Automatische 8-traps batterijlader met Power stream technologie: Tot 50% efficiënter dan traditionele laders.

- Constante procescontrole en efficiënte power transfer resulteren in snellere laadtijd en langere levensduur van de batterijen
- Automatische herkenning van 6, 12 en 24V batterijen type PB, GEL, AGM:MF, SPIRAL, STARTSTOP
- Bescherming tegen polariteitswissel, kortsluiting, overbelasting, beschadigde batterijen.
- 8-traps batterijlader met boost en druppellader met Pulse Tronic. Herstelt en laadt diep ontladen en gesulfateerde batterijen.
- Model 50 biedt starthulp bij batterijpech.
- Optionele muurbeugel 830803066

Order nr.		830807572 €	830807573 €
Orig. nr.		PULSE 30	PULSE 50
Spanning	V	230	230
Laadspanning	V	6-12/24	6-12/24
Laadstroom	A	25-25-12	45-45-23
Startstroom	Max. A cc		70
Referentiecapaciteit	Ah 15h (min/max)	5/400	10/600
Opgenomen vermogen	kW	0,35	0,57
Gewicht	kg	2,00	2,30
Afmetingen (l x b x h)	mm	170 x 65 x 35	170 x 65 x 35
Prijs	€	184,00	206,00



Kleine 12/24 V lader voor loodbatterijen. Met LED batterijindicator en overbelastingszekering.

Order nr.		830807555 €
Orig. nr.		TOURING 15
Spanning	V	230
Laadspanning	V	12/24
Startcapaciteit	Ah	115-55
Uitgangsstroom	A	9-4,5
Opgenomen vermogen	kW	0,1
Gewicht	kg	2,70
Afmetingen (l x b x h)	mm	100 x 190 x 190
Prijs	€	44,90



Muurbeugel voor Doctor/pulse

Order nr.		830803066 €
Orig. nr.		803066
Prijs	€	22,50



**LADER
TESTER
MANAGER**

• digitaal display

Automatische 8-traps **batterijlader, batterijtester en manager.**

Tot 50% efficiënter dan traditionele laders.

- Automatische herkenning van 6, 12 en 24V batterijen type PB, GEL, AGM:MF, SPIRAL, STARTSTOP
- Bescherming tegen polariteitswissel, kortsluiting, overbelasting, beschadigde batterijen.
- **8-traps batterijlader** met boost en druppellader met Pulse Tronic. Herstelt en laadt diep ontladen en gesulfateerde batterijen.
- bewaakt automatisch het laadniveau en spanning
- snellere laadtijd en langere levensduur van de batterijen
- Handmatig laadcurves oproepbaar.
- Batterij, start- en alternatortester
- Model 50 biedt starthulp bij batterijpech.
- Stabiele stroombron voor voertuigen zonder batterij (showrooms, garage, diagnose,...)
- **Memory function** voorkomt verlies van data op boordcomputers.
- Optionele muurbeugel 830803066

Order nr.		830807570 €	830807571 €
Orig. nr.		DOCTOR 30	DOCTOR 50
Spanning	V	230	230
Laadspanning	V	6-12/24	6-12/24
Laadstroom	A	25-25-12	45-45-23
Startstroom	Max. A cc	70	70
Referentiecapaciteit	Ah 15h (min/max)	5/400	10/600
Opgenomen vermogen	kW	0.35	0.57
Gewicht	kg	2,00	2,30
Afmetingen (l x b x h)	mm	170 x 65 x 35	170 x 65 x 35
Prijs	€	242,00	272,00



Digitale batterijlader en starter voor lood, Gel, AGM en start-stop batterijen in 12 en 24 V. Zware type Starter voor personenwagens en lichte bestelwagens. Digitaal display voor stroom/voltage. Test functie. PULSE-TRONIC : Elektronische sturing voor een langere levensduur van de batterijen door o.a. constante proces-controle en optimalisatie, gereduceerde laadtemperatuur, bescherming van boordinstrumenten en laden van bijna lege batterijen.

Order nr.		830829327 €
Orig. nr.		DIGIStart 340
Spanning	V	230
Laadspanning	V	12/24
Laadstroom	A	30
Startstroom	Max. A cc	300
Referentiecapaciteit	Ah 15h (min/max)	6/700
Opgenomen vermogen	kW	1/6,4
Geschikt voor loodbatterij		✓
Geschikt voor gel/AGM batterij		✓
Geschikt voor Ni-Cd batterij		✓
Gewicht	kg	13,80
Afmetingen (l x b x h)	mm	330 x 360 x 650
Prijs	€	410,00

Batterijladers en snelstarters met transformator



Compacte batterijlader. Voor het laden van loodbatterijen. Bescherming tegen overload en verkeerde aansluiting. Met ampèremeter en klemmen.

Order nr.	830807023	830807024	830807026
	€	€	€
Orig. nr.	NEVADA 11	NEVADA 12	NEVADA 15
Spanning	V 230	230	230
Laadspanning	V 12	12	12/24
Laadstroom	A 2,5	4	6-3A
Opgenomen vermogen	kW 0,05	0,08	0,11
Capaciteit batterij	Ah 90	90	90
Voor loodbatterij	✓	✓	✓
Referentiecapaciteit	Ah (15h min/max) 25/40	40/70	60/115(12V) 30/40(24V)
Gewicht	kg 1,66	1,78	2,63
Afmetingen (l x b x h)	mm 95 x 190 x 180	95 x 190 x 180	95 x 190 x 180
Prijs	€ 56,90	59,90	70,90



Compacte batterijlader met automatische controle van de laadstroom en automatisch stopzetten en hervatten van het laden waarden. Voorzien van waarschuwingslichtjes voor signalisatie van correcte voeding en polariteitsomkering. Speciaal ontworpen voor het laden van hermetisch afgesloten batterijen (GEL) met een spanning van 12V en/of 24 V. Functie TRONIC : Elektronisch gestuurde laders/starters. Mogelijkheden o.a.: desulfateren, druppelladen en bescherming tegen verkeerd aansluiten.

Order nr.	830807027	830807045
	€	€
Orig. nr.	NEVATRONIC 12	NEVATRONIC 24
Spanning	V 230	230
Laadspanning	V 12	12/24
Laadstroom	A 6	6-4,5
Opgenomen vermogen	kW 0,09	0,11
Voor gelbatterij	✓	✓
Voor AGM batterij	✓	✓
Referentiecapaciteit	Ah (15h min/max) 40/50	40/55 (12V) 30/45 (24V)
Gewicht	kg 2,25	2,55
Afmetingen (l x b x h)	mm 95 x 190 x 180	95 x 190 x 180
Prijs	€ 82,50	93,50



Monofazige batterijlader met BOOST functie. Voor het laden van loodbatterijen met een spanning van 12V/24V. Bescherming tegen overload en verkeerde aansluiting. Metalen behuizing. Schakelaar voor keuze tussen normaal laden en snel laden. Met ampèremeter.

Order nr.	830807545	830807547
	€	€
Orig. nr.	ALPINE 18	ALPINE 30
Spanning	V 230	230
Laadspanning	V 12/24	12/24
Laadstroom	A 9,5	20
Opgenomen vermogen	kW 0,2	0,8
Capaciteit batterij	Ah 120	200
Voor loodbatterij	✓	✓
Referentiecapaciteit	Ah (15h min/max) 14/185(12V)	15/400
Gewicht	kg 3,45	8,60
Afmetingen (l x b x h)	mm 170 x 250 x 165	225 x 290 x 205
Prijs	€ 88,50	150,00



Monofazige batterijlader met START functie. Voor het laden van loodbatterijen met een spanning van 12V/24V en het starten van benzinemotoren (Leader 150-220) en dieselmotoren (Leader 400). Bescherming tegen overload en positieve aansluiting. Snel laden. Met ampèremeter.

Order nr.	830807549	830807550	830807551
	€	€	€
Orig. nr.	LEADER 150	LEADER 220	LEADER 400
Spanning	V 230	230	230
Laadspanning	V 12	12/24	12/24
Laadstroom	A 14	20	45
Opgenomen vermogen	kW 0,3/1,4	0,8/3,6	1,6/4
Starter	✓	✓	✓
Capaciteit batterij	Ah 200	200	200
Capaciteit koude batterij	Ah 20	60	90
Capaciteit batterij na voorverwarming	Ah 60	100	120
Startstroom	Max. A cc 140	180	300
Voor loodbatterij	✓	✓	✓
Referentiecapaciteit	Ah (15h min/max) 25/250	30/400	20/700
Gewicht	kg 6,60	9,40	10,85
Afmetingen (l x b x h)	mm 225 x 290 x 205	225 x 290 x 205	265 x 345 x 230
Prijs	€ 134,00	165,00	209,00



Monofazige batterijlader met automatische controle van de oplaadstroom voor lood- en gelbatterijen met een spanning van 12/24V. Keuze tussen normaal laden, snel laden (BOOST), buffermodus en druppelladen. Het automatisch opladen is geschikt voor hermetische batterijen (GEL) en het druppelladen voor traditionele batterijen met accuvloeistof. Bescherming tegen overbelasting en omkeren van de polariteit. Met ampèremeter. Functie TRONIC : Elektronisch gestuurde laders/starters. Mogelijkheden o.a.: desulfateren, druppelladen en bescherming tegen verkeerd aansluiten.

Order nr.	830807540 €	
Orig. nr.	AUTOTRONIC 25 BOOST	
Spanning	V	230
Laadspanning	V	12/24
Laadstroom	A	18-12
Opgenomen vermogen	kW	0,3
Capaciteit batterij	Ah	120
Voor loodbatterij		✓
Voor gelbatterij		✓
Voor AGM batterij		✓
Referentiecapaciteit	Ah (15h min/max)	30/225(12V) - 20/180(24V)
Gewicht	kg	7,20
Afmetingen (l x b x h)	mm	225 x 290 x 205
Prijs	€	148,00



Professionele, draagbare, batterijlader voor de garage. Voor het laden van alle types van loodbatterijen met een spanning van 6/12/24/36/48V. Laat het gelijktijdig laden toe van meerdere batterijen in serie. Uitgerust met ampèremeter en voltmeter.

Order nr.	830807063 €	
Orig. nr.	COMPUTER48/2	
Spanning	V	230
Laadspanning	V	6-12/24-36-48
Laadstroom	A	11-30-30-30-27
Conventionele stroom EN 60335-2-29	A	7-20-20-20-18
Referentiecapaciteit	Ah 15h (min/max)	10/100-300-300-300-300
Opgenomen vermogen	kW	1
Instelposities laadstroom		6
Voor loodbatterij		✓
Gewicht	kg	12,70
Afmetingen (l x b x h)	mm	280 x 350 x 320
Prijs	€	361,00



DYNAMIC 420



DYNAMIC 520

CHARGE & START



DYNAMIC 620



Batterijlader - starter op wielen, voor het laden van loodbatterijen met een voltage van 12/24V en voor het starten van alle types van auto's, bestelwagens, lichte vrachtwagens, traktoren en vrachtwagens. Werkt op het lichtnet, en niet met batterij. Bescherming tegen overload en positieve aansluiting. Keuze uit normaal laden, snel laden en snel starten. Timer (type 520 en 620) weergave van de laadstroom en de startstroom via ampèremeter.

Order nr.	830829382 €	830829383 €	830829384 €
Orig. nr.	DYNAMIC 420	DYNAMIC 520	DYNAMIC 620
Spanning	V	230	230
Laadspanning	V	12/24	12/24
Laadstroom	A	50	75
Opgenomen vermogen	kW	1,6/10	1,6/10
Starter		✓	✓
Startstroom	Max. A cc	400	400
Voor loodbatterij		✓	✓
Referentiecapaciteit	Ah (15h min/max)	20/1000	20/1000
Gewicht	kg	16,90	20,30
Afmetingen (l x b x h)	mm	330 x 360 x 650	320 x 480 x 735
Prijs	€	280,00	367,00

Starters-Boosters

MACHINES



Draagbare startbooster met batterij, voor het starten met 12V van auto's, bestelwagens, boten, kleine landbouwmachines. Hij onderhoudt de spanning op alle circuits gedurende het vervangen van de batterij; 12V krachtbron voor in noodgevallen. Beschadigt de elektronica van het voertuig niet. Herladen met 220V netwerk adapter, of met 12Vaanstekerruitgang. Met kabels, tangen en 3,6W lamp. Om de perfecte werking van de batterij te behouden, opnieuw opladen gedurende 12 uur voor en na ieder gebruik en iedere 3 maanden. Geschikt voor alle types batterijen. Geleverd met oplader 12V passend op sigarenaansteker.

Order nr.	830829512 €	
Orig. nr.	SPEED START 1812	
Booster	✓	
Capaciteit batterij	Ah	38
Spanning	V	230
Laadspanning	V	12
Startstroom	Max. A cc	1500
Gewicht	kg	14,60
Afmetingen (l x b x h)	mm	200 x 320 x 350
Prijs	€	210,00



Draagbare startbooster met batterij, voor het starten met 12V (2212) of 12/24V (2824) van auto's, bestelwagens, boten, kleine landbouwmachines. Wanneer geconnecteerd aan de aansteker in de wagen, onderhouden ze spanning op alle circuits gedurende het vervangen van de batterij; 12V krachtbron voor in noodgevallen. Beschadigen de elektronica van het voertuig niet. Herladen met 220V netwerk adapter, of met aanstekerruitgang van. Met kabels, tangen en 3,6W lamp. Om de perfecte werking van de batterij te behouden, opnieuw opladen gedurende 12 uur voor en na ieder gebruik en iedere 3 maanden. Met geluidsalarm tegen omgekeerde polariteit, LED-lamp die de staat van de batterij aangeeft en 2 x 12V stekkers. Geleverd met oplader 12V passend op cigarenaanteker.

Order nr.	830829516 €		830829517 €
Orig. nr.	PRO START 2212		PRO START 2824
Capaciteit batterij	Ah	34	44-22
Spanning	V	230	230
Laadspanning	V	12	12/24
Startstroom	Max. A cc	1800	2500
Uitgangsstroom	A		800
Gewicht	kg	14,60	16,10
Afmetingen (l x b x h)	mm	205 x 335 x 360	205 x 335 x 360
Prijs	€	247,00	286,00



STARTPLUS4824

STARTPLUS6824



Professionele, krachtige starter-booster met batterij, voor het starten van voertuigen op 24V en 12 V. Werkt op basis van een batterij en is dus autonoom. 12V krachtbron voor in noodgevallen. Beschadigen de elektronica van het voertuig niet. Herladen met 220V netwerk adapter, of met T-CHARGE 12 (inbegrepen bij model 4824). Met startkabels en tangen geleverd. Om de perfecte werking van de batterij te behouden, opnieuw opladen gedurende 12 uur voor en na ieder gebruik en iedere 3 maanden.

Order nr.	830829558 €	830829560 €
Orig. nr.	STARTPLUS 4824	STARTPLUS 6824
Capaciteit batterij	Ah 100(12V) - 50(24V)	130(12V) - 65(24V)
Capaciteit koude batterij	Ah 180	180
Spanning	V 230	230
Laadspanning	V 12/24	12/24
Startstroom	Max. A cc 4400(12V) - 2200(24V)	6000(12V) - 3000(24V)
Startcapaciteit	Ah 180	180
Uitgangsstroom	A 1600(12V) - 800(24V)	2000(12V) - 1000(24V)
Lengte kabel	m 2	3
Gewicht	kg 55,40	55,40
Afmetingen (l x b x h)	mm 305 x 360 x 630	450 x 460 x 760
Prijs	€ 795,00	1.196,00



Startbooster voor het starten op 12V.

Voordelen:

- Licht en draagbaar, past in elke koffer
- Eenvoudig in gebruik
- Bescherming tegen verkeerde polariteit (LED lamp)
- Met hulplicht

Geleverd met 12V en 230V oplaadstekker, passend op sigarenaansteker.

Order nr.	829000100 €
Orig. nr.	BT1200
Capaciteit batterij	Ah 17
Spanning	V 230
Laadspanning	V 12
Startstroom	Max. A cc 1000
Gewicht	kg 12,00
Prijs	€ 85,00



Draagbare startboosters op batterij, voor het starten op 12 of 12/24V van auto's, bestelwagens, ...

Kenmerken:

- Start voertuigen zonder netstroom langs de snelweg, in de garage, ...
- Metalen behuizing met handvat en krassvrij anti-slip bodemstuk.
- Eenvoudig bedieningspaneel met batterijtest en led-indicator.
- Herladen met 220V netwerkadapter.
- Geschikt voor alle types batterijen.

Geleverd met :

- Kabels en tangen.
- Oplader 12V passend op sigarenaansteker.

Om de perfecte werking van de batterij te behouden: op laden voor en na ieder gebruik en iedere 3 maanden.

Order nr.	829000110 €	829000120 €
Orig. nr.	DUAL START 3412	DUAL START 3424
Capaciteit batterij	Ah 2 x 22	2x22
Spanning	V 230	230
Laadspanning	V 12	12/24
Startstroom	Max. A cc 2400	2400(12V) en 1200(24V)
Uitgangsstroom	A 1200	
Lengte kabel	m 1,12	1,12
Kabelsectie	mm ² 19,5	19,5
Gewicht	kg 15,00	15,00
Afmetingen (l x b x h)	mm 287 x 218 x 336	287 x 218 x 336
Prijs	€ 219,00	299,00

12/24V		20Ah	60Ah	80Ah	100Ah	150Ah	250Ah
CHARGE	NOVA 15						
	NOVA 30						
START CHARGE	NOVA 50S						
	NOVA 400S			START			
	NOVA 600S			START			
START	DUAL START 3412				START		
	DUAL START 3424				(12V)		



NOVA400S

NOVA600S

Mobiele batterijlader-starter.

NOVA400S

- Batterijspanning 12 en 24V.
- Met transformator voor het opladen van loodaccu's en het snelstarten van auto's, bestelwagens, vrachtwagens,...
- Met functies normaal en snel laden (boost), en snelstarten (START).
- Met thermische beveiliging tegen overladen en tegen polariteitswissel.
- Snel verwisselbare zekeringen op het frontale bedieningsbord.
- Uitgerust met kabels, klemmen, ampèremeter, draagbeugel; wielen en opbergvak voor kabels.
- Geleverd met oplader 12V passend op cigarenaansteker.
- CE conform.

NOVA600S met timerfunctie.

Order nr.	829000190 *	829000192 *
Orig. nr.	NOVA400S	NOVA600S
Spanning	V 230	V 230
Laadspanning	V 12/24	V 12/24
Startstroom	Max. A cc 240	540
Startcapaciteit	Ah 50	70
Laadstroom	A 40	60
Referentiecapaciteit	W 40/700	60/1000
Opgenomen vermogen	kW	
Gewicht	kg 16,00	26,00
Prijs	€ 123,00	153,00



Draagbare batterijlader-starter met transformator voor het opladen van loodaccu's en het snelstarten van auto's en bestelwagens.

Kenmerken:

- Voor batterijspanning 12 en 24V.
- Met functies normaal en snel laden (boost), en snelstarten (START).
- Met thermische beveiliging tegen overladen en tegen polariteitswissel.
- Snel verwisselbare zekeringen op het frontale bedieningsbord.
- Uitgerust met ampèremeter,
- Draagbeugel
- Opbergvak voor kabels.
- Geleverd met oplader 12V passend op cigarenaansteker.
- CE conform.

Order nr.	829000182 B
Orig. nr.	NOVA 50S
Spanning	V 230
Laadspanning	V 12/24
Startstroom	Max. A cc 180
Laadstroom	A 40
Referentiecapaciteit	Ah (15h min/max) 40/700
Referentiecapaciteit	W 40/700
Opgenomen vermogen	kW
Gewicht	kg 14,50
Afmetingen (l x b x h)	mm 325 x 310 x 215
Prijs	€ 91,90

Testers



Batterijtester. Controleert elke pool van de batterij apart. Met grote display 6 - 12V. Met weerstand die effectieve capaciteit test onder belasting.

Order nr.	830802517	
Orig. nr.	802517	
Spanning	V	6-12
Capaciteit	Ah	20-200
Testfuncties	1	
Gewicht	kg	0,48
Prijs	€	65,50



Digitale batterijtester. 12V. Test alle soorten batterijen : WET/GEL/AGM/MF. Met start test 110-1440 A en ladingstest.

Order nr.	830802605	
Orig. nr.	DT400	
Spanning	V	12
Capaciteit	Ah	20-200
Testfuncties	2	
Gewicht	kg	0,18
Prijs	€	80,50



Digitale batterijtester. 12V. Test alle soorten batterijen : WET/GEL/AGM/MF. Met start test 110-1440 A, ladingstest,

Alternator, circuittest en startstelsysteemtest.

Gebruiksvriendelijk LCD-Display.

Order nr.	830802665	
Orig. nr.	802665	
Spanning	V	12
Capaciteit	Ah	20-200
Testfuncties	3	
Gewicht	kg	2,00
Prijs	€	122,00



Controleert direct de lading van uw autobatterij of van uw snelstarter, via de sigarettenaansteeker.

Order nr.	830802695	
Orig. nr.	JUMP START CHECK	
Testspanning	V	12/24
Prijs	€	17,50



Analoge batterijtester 6 en 12Volt

- test zowel batterijcapaciteit, als startcapaciteit (CCA)
- test alternator van het voertuig (12V)

Order nr.	830802780	
Orig. nr.	T125	
Spanning	V	6/12
Capaciteit	Ah	20-100
Batterij test	AAA	✓
Alternator test	✓	
Startcapaciteit	✓	
Gewicht	kg	0,18
Prijs	€	47,90



NEW



Batterijtester met start- en alternatorstest. 12V. met weerstand.

Order nr.	830802781	
Orig. nr.	T500	
Spanning	V	12
Capaciteit	Ah	10-160
Batterij test	AAA	✓
Alternator test	✓	
Startcapaciteit	✓	
Gewicht	kg	0,18
Prijs	€	104,00

Stroomomvormers



Interfacekabel tussen Telwin PROSTART boosters en OBD II poort van uw voertuig. Door de stroomvoorziening wordt het geheugen van uw boordcomputer niet gewist bij loskoppelen van de autobatterij. Universeel bruikbaar.

Order nr.	830802693 €
Orig. nr.	802693
Prijs	€ 20,50

MACHINES



Stroomomvormer van 12V naar 230V AC. Ideaal voor stroomvoorziening in de wagen en kampeervagen voor draagbare TV, scheermachine, smartphone, laptop, camera,... Compleet met aansluiting voor sigarettenaansteker. Draagbaar en compact. Beschermd tegen polariteitsomkeer en overbelasting.

Order nr.	830829440	830829446	830829447
Orig. nr.	CONV70	CONV500	CONV1000
Ingangsspanning	V 12	V 12	V 12
Uitgangsspanning	V 230	V 230	V 230
Uitgangsfrequentie	Hz 50	Hz 50	Hz 50
Maximum vermogen	W 70	W 500	W 1000
Afmetingen (l x b x h)	mm 115 x 60 x 35	mm 232 x 130 x 71	mm 337 x 130 x 71
Prijs	€ 52,50	€ 125,00	€ 230,00



Stroomomvormer van 12V naar 230V wisselspanning AC. Ideaal voor stroomvoorziening in de wagen: smartphones, laptop, camera, tablets,... met 2x USB uitgang en 1x 230V AC uitgang. Compleet met aansluiting voor sigarettenaansteker. Draagbaar en compact. Beschermd tegen polariteitsomkeer en overbelasting.

Order nr.	830829444	
Orig. nr.	USB CONVERTER 310	
Ingangsspanning	V	12
Uitgangsspanning	V	230
Uitgangsfrequentie	Hz	50
Maximum vermogen	W	300
Gewicht	kg	0,50
Afmetingen (l x b x h)	mm	172 x 85 x 52
Prijs	€	71,50

Accessoires



Set startkabels. Lengte 3m. 16mm² (voor personen- en bestelwagens) of 25 mm² (voor vrachtwagens).

Order nr.	830802515	830802516	
Orig. nr.	802515	802516	
Capaciteit	mm ² /A	16/220	25/350
Prijs	€	55,90	91,50



Stroomkabel voor Telwin Doctor

Order nr.	830802793	830802794	
Orig. nr.	802793	802794	
Voor type	DOCTOR	DOCTOR	
Lengte kabel	m	6	10
Prijs	€	43,90	57,90



Aansluitklemmen batterijladers.

Order nr.	Orig. nr.	Omschrijving	Prijs
830802527	802527	Rood 40 A	4,30
830802528	802528	Zwart 40 A	4,70
830802529	802529	Rood 60 A	5,20
830802530	802530	Zwart 60 A	5,20
830802531	802531	Rood 150 A	4,30
830802532	802532	Zwart 150 A	4,50



Set zekeringen. VE = verpakkingseenheid.

Order nr.	Orig. nr.	Voor type	Amp-ère	Af-beel-ding	Leng-te	VE	Prijs/VE
			A		mm		€
830802258	802258	Computer 48/2 - Leader	30	a	-	20	9,00
830802029	802029	150,220 - Dynamic 220 - Digitrony 230	100	a	-	20	10,90
830802260	802260	Dynamic 420 - Dynamic 520	80	a	-	20	9,00
830802131	802131	Energy 650	100	b	100	10	17,50
830802257	802257	-	20	b	-	10	3,30
830802129	802129	Energy 1000	300	b	120	10	34,90
830802319	802319	Nevada 5 - Nevada 6	4	c	-	10	6,50
830802265	802265	Nevada 10 - Nevada 11 - Nevada 12 - Alpine 13	7,5	c	-	10	3,30
830802255	802255	Mototron 6/12 - Nevada 15	10	c	-	10	3,30
830802256	802256	Nevatron 24 - Alpine 18 - Alpine 30	15	c	-	10	3,30
830802114	802114	Autotron 25	30	c	-	10	6,50
830802259	802259	Alpine 50 - Leader 400 - Digistart 340 - Dynamic 3000	50	a	-	20	9,00
830122438	122438	Oud model - Lengte 6 cm	80	b	60	1	2,40
830121003	121003	Oud model - Lengte 3 cm	100	b	30	10	1,10
830122452	122452	Oud model - Lengte 8 cm	100	b	80	1	2,50



Universele oplader voor Telwin startboosters, type Speedstart en Pro start, en Metalworks startboosters type Dual start.

Order nr.	830169190	
Orig. nr.	169692	
Gewicht	kg	0,80
Afmetingen (l x b x h)	mm	150 x 150 x 150
Prijs	€	26,30

LASSEN

TELWIN is aanwezig op de 5 continenten, op 120 markten, met een sterk geworteld distributienetwerk die betrouwbaarheid en professionele service garandeert. Telwin betekent snelheid, nauwkeurigheid en efficiëntie; een absolute garantie voor haar klanten. Daarnaast zorgt Telwin voor advies, assistentie, en informatie via het Telwin Training Lab, de plaats bij uitstek voor alle opleidingsactiviteiten. Telwin heeft de grootste en meest complete aanbod op de markt.





Industrial - Automotive - Charging - Professional - Consumer

TELWIN: PRODUCTS FOR 360° SOLUTIONS WORLDWIDE PRESENCE



MMA lasapparaten



Dragbaar inverter lasapparaat voor MMA lassen in gelijkstroom.

Bestemd voor gebruik met stroomgroepen.

Voordelen:

- Compact en licht
- Zeer hoge stabiliteit van de lasstroom, ook bij spanningsschommelingen
- Thermische beveiliging

Gemakkelijk lassen:

- **Hot Start** voor een optimale opstart zonder spatten.
- **Arc Force** voor het behouden van de vlamboog tijdens contact met het smeltbad.
- **Anti stick** voorkomt dat elektrodes kleven bij een te lage lasroom.
- Bescherming tegen overbelasting, overspanning en onderspanning

Geschikt voor:

- De meeste types van elektrodes: rutiel, basisch, inox, gietijzer.
- Het aansluiten op stroomgeneratoren en onstabiele stroomvoorziening (bijvoorbeeld lange verlengkabels).
- Heel geschikt voor bouwerven.

Geleverd met lasaccessoires en plastic koffer.

Order nr.	830816211 €	
Orig. nr.	FORCE 168 MPGE	
Spanning	V	230
Inschakelduur (stroom @ 60%)	A	70
Inschakelduur I _{max}	A @ %	140 @ 7%
Regelbereik	A	10-150
Capaciteit elektroden	mm	1,6-4,0
Opgenomen vermogen 60%/maximum	kW	1,6-4,0
Opgenomen stroom 60%/maximum	A	-/4,1
Nullastspanning	V	72
Kranchfactor	cos fi	0,6
Beschermingsklasse	IP	21
Geschikt voor staal		✓
Geschikt voor RVS		✓
Geschikt voor alu		✓
Lastype		MMA
Gewicht	kg	5,50
Afmetingen (l x b x h)	mm	380 x 420 x 170
Prijs	€	312,00



Dragbare inverter lasapparaten voor MMA lassen in gelijkstroom.

Voordelen:

- Licht en compact
- Hoge stabiliteit van de vlamboog
- Motogenerator (max +/- 15%)
- Thermische beveiliging

Gemakkelijk lassen:

- **Hot Start** voor een optimale opstart zonder spatten.
- **Arc Force** voor het behouden van de vlamboog tijdens contact met het smeltbad.
- **Anti stick** voorkomt dat elektrodes kleven bij een te lage lasroom.
- Bescherming tegen overbelasting, overspanning en onderspanning

Geschikt voor:

- Elektrodes: basisch, rutiel, inox, gietijzer

Geleverd met lasaccessoires en koffer.

Order nr.	830816202 €	830816203 €	830816204 €
Orig. nr.	TECNICA 151/S	TECNICA 171/S	TECNICA 211/S
Spanning	V	230	230
Inschakelduur (stroom @ 60%)	A	95	
Inschakelduur I _{max}	A @ %	130 @ 30%	140A@25% 170A@18%
Regelbereik	A	5-130	5-150 10-170
Capaciteit elektroden	mm	1,6-3,2	3,8 4,0
Opgenomen vermogen 60%/maximum	kW	2,6/3,9	
Nullastspanning	V	75	70 79
Kranchfactor	cos fi	0,7	
Beschermingsklasse	IP	21	
Geschikt voor staal		✓	✓ ✓
Geschikt voor RVS		✓	✓ ✓
Geschikt voor alu		✓	✓ ✓
Lastype		MMA	MMA MMA
Gewicht	kg	6,50	6,90 6,90
Afmetingen (l x b x h)	mm	380 x 420 x 170	380 x 420 x 170 380 x 420 x 170
Prijs	€	293,00	319,00 374,00



Draagbaar inverter lasapparaat voor MMA lassen in gelijkstroom.

bestemd voor gebruik met stroomgroepen.

Voordelen:

- Compact en licht
- Zeer hoge stabiliteit van de lasstroom, ook bij voltageschommelingen
- Thermische beveiliging

Gemakkelijk lassen:

- **Hot Start** voor een optimale opstart zonder spatten.
- **Arc Force** voor het behouden van de vlamboog tijdens contact met het smeltbad.
- **Anti stick** voorkomt dat elektrodes kleven bij een te lage lasstroom.
- Bescherming tegen overbelasting, overspanning en onderspanning

Geschikt voor:

- Het aansluiten op stroomgeneratoren en onstabiele stroomvoorziening (bijvoorbeeld lange verlengkabels).
- Geschikt voor bouwerven.
- Eenvoudig in gebruik met de meeste types van elektrodes: rutiel, basisch, inox, gietijzer.

Geleverd met lasaccessoires en plastic koffer.

Order nr.	830816212 E	
Orig. nr.	TECNICA188	
Spanning	V	230
Regelbereik	A	10-150
Capaciteit elektroden	mm	1,6-4,0
Opgenomen vermogen 60%/maximum	kW	2,6/4,2
Opgenomen stroom 60%/maximum	A	17/28
Nullastspanning	V	75
Kranchfactor	cos fi	0,86/0,7
Beschermingsklasse	IP	23
Lastype	MMA	
Gewicht	kg	7,00
Afmetingen (l x b x h)	mm	380 x 420 x 170
Prijs	€	363,00



Draagbare inverter lasmachine voor elektrode lassen.

Bestemd voor gebruik met stroomgroepen.

Voordelen:

- Hoge lasstroom en hoge inschakelduur 35%
- Voor gebruik op stroomgroepen en op lange verlengkabels op de werf
- Bescherming tegen spanningspiek- en val.
- Zeer stabiele lasstroom, met hot start, anti stick en arc force
- Thermische bescherming

Geschikt voor:

- Rutiel, basisch, inox, gietijzer
- Ook voor Cellulose en aluminium elektrodes
- LIFT DC-TIG lassen met optionele set mogelijk.

Geleverd met alu koffer, elektrodehouder en massatang.

Order nr.	830816213 E	
Orig. nr.	TECNOLOGY 238	
Spanning	V	230
Inschakelduur (stroom @ 60%)	A	140
Inschakelduur I _{max}	A @ %	180
Regelbereik	A	5-180
Capaciteit elektroden	mm	6
Opgenomen vermogen 60%/maximum	kW	4,3-6
Opgenomen stroom 60%/maximum	A	27-36
Nullastspanning	V	102
Kranchfactor	cos fi	0,7
Beschermingsklasse	IP	23
Lastype	MMA	
Gewicht	kg	6,00
Prijs	€	719,00



Transfo lasapparaten met koelventilatie.

Kenmerken:

- Traploze regeling van de lasroom.
- Thermische beveiliging.

Geslacht voor:

- Voor MMA lassen in wisselstroom (AC)
- Bruikbare elektrodes: rutiel.



Geleverd met elektrode lasaccessoires.

Order nr.	830809200	
Orig. nr.	MODERNA 150	
Spanning	V	230
Regelbereik	A	40-140
Capaciteit elektroden	mm	1,6-3,2
Opgenomen vermogen 60%/maximum	kW	-/2,5
Nullastspanning	V	48
Beschermingsklasse	IP	21
Geslacht voor staal		✓
Geslacht voor RVS		✓
Geslacht voor alu		✓
Lastype		MMA
Gewicht	kg	13,90
Afmetingen (l x b x h)	mm	345 x 215 x 280
Prijs	€	143,00



Transfo lasapparaten met koelventilator

Geslacht voor:

- Voor MMA lassen in wisselstroom (AC).
- Bruikbare elektrodes: rutiel.

Kenmerken:

- Variabele regeling van de lasroom.
- Model Artika 252 met dubbel secundair voltage voor gemakkelijker lassen van basische elektrodes.



- Thermische beveiliging
- Geleverd met lasklem en massatang

Order nr.	830814193	
Orig. nr.	NORDIKA 2160	
Spanning	V	230
Regelbereik	A	55-160
Opgenomen vermogen 60%/maximum	kW	-/2,5
Nullastspanning	V	49
Beschermingsklasse	IP	21
Lastype		MMA
Gewicht	kg	17,20
Afmetingen (l x b x h)	mm	640 x 325 x 435
Prijs	€	182,00



Transfo lasapparaten met koelventilatie.

Kenmerken:

- Traploze regeling van de lasroom.
- Thermische beveiliging.

Geslacht voor:

- Voor MMA lassen in wisselstroom (AC).
- Bruikbare elektrodes: rutiel.

Geleverd met elektrode lasaccessoires.

Order nr.	830814196	
Orig. nr.	NORDIKA 3250	
Spanning	V	230/400 1 ph
Regelbereik	A	55-250
Opgenomen vermogen 60%/maximum	kW	-/4,2
Nullastspanning	V	50
Beschermingsklasse	IP	21
Lastype		MMA
Gewicht	kg	21,70
Afmetingen (l x b x h)	mm	700 x 325 x 440
Prijs	€	280,00

Accessoires MMA



Laskabelset MMA voor Telwin en Metalworks.

Order nr.	Technische gegevens	Lasroom	Prijs
		A	€
830801003	25mm ² 3+2m, DX25	tot 250 A - Nordika 3250	79,50
830801000	10mm ² 3+2m, DX25	tot 130	55,90
830801096	16mm ² 3+2m, DX25	tot 200	67,50
830801102	25mm ² 3+2m, DX25	tot 280	67,50
830801081	25mm ² 4+3m, DX50	tot 280	111,00
830801095	35mm ² 4+3m, DX50	tot 350	137,00
830801093	50mm ² 4+3m, DX50	tot 500	182,00

MIG-MAG lasapparaten



TELMIG 170/1



TELMIG 180/2



TELMIG 200/2



MIG-MAG transfo lastoestellen met koeling.

Kenmerken:

- Voorzien voor continu lassen.
- Voor verschillende types van materialen zoals staal, inox en aluminium.

Model 180/200: puntlasfunctie met regelbare timer. Met vaste toorts van 2,5 m.

Model 200: Met euro connector toorts van 3 m.

Geleverd met rolletje draad en gasregelaar voor hervulbare fles.

Order nr.		830821054 €	830821055 €	830821056 €
Orig. nr.		TELMIG 170/1	TELMIG 180/2	TELMIG 200/2
Spanning	V	230	230	230
Inschakelduur (stroom @ 60%)	A	80	80	100
Inschakelduur I _{max}	A @ %	140 @ 15%	140@20%	100@15%
Regelbereik	A	30-160	30-170	35-220
Capaciteit elektroden	mm	1,6-3,2		
Opgenomen vermogen 60%/maximum	kW	2,3/5,2	2,3/5,2	3/7
Nullastspanning	V	31	31	33
Bobijn maximum	kg/mm	5/300	15/300	15/200
Kranchfactor	cos fi	0,9	0,9	0,6
Beschermingsklasse	IP	21	21	22
Capaciteit staal lasdraad	mm	0,6-0,8	0,6-0,8	0,6/1
Capaciteit inox lasdraad	mm	0,8	0,8	0,8
Capaciteit alu lasdraad	mm	0,8-1	0,8-1	0,8-1
Mobiel		✓	✓	✓
Gewicht	kg	36,80	36,40	44,90
Afmetingen (l x b x h)	mm	800 x 450 x 570	800 x 450 x 570	800 x 450 x 655
Prijs	€	619,00	659,00	829,00

MIG-MAG-FLUX lasapparaten

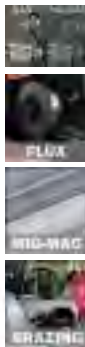

Inverter halfautomaat voor MIG-MAG, FLUX en brazeren-hardsolderen.
Veelzijdig lastoestel met breed toepassingsveld voor het lassen van staal, alu, inox en brazeren -hardsolderen van verzinkt staal, koper, zink, ...

Kenmerken:

- Synergische instelling van de materiaaldikte voor snel en gemakkelijk lassen met optimale lasparameters, met manueel regeling van de lasdikte.
- Zeer compact en licht toestel.
- Thermische beveiliging en beveiliging tegen overspanning en onderspanning (max +15%)

Geleverd met lastoorts 2,5m, laskit voor staal en gasontspanner.
Optioneel: trolley voor gemakkelijk transport, laskits voor alu of inox.

Order nr.	830816050 E	
Orig. nr.	TECHNOMIG150	
Spanning	V	230
Inschakelduur (stroom @ 60%)	A	65
Regelbereik	A	20-150
Opgenomen vermogen 60%/maximum	kW	1,2/2,8
Opgenomen stroom 60%/maximum	A	8,7/20
Nullastspanning	V	52
Krachtfactor	cos fi	0,86/0,7
Beschermingsklasse	IP	23
Capaciteit staal lasdraad	mm	0,6/0,8
Capaciteit inox lasdraad	mm	0,8
Capaciteit alu lasdraad	mm	0,8/1
Capaciteit gevulde lasdraad	mm	0,8/1,2
Braseerdraad	mm	0,8
Geschikt voor staal		✓
Geschikt voor RVS		✓
Geschikt voor alu		✓
Geschikt voor lassen zonder gas		✓
Geschikt voor braseren		✓
Mobiel		✓
Inschakelduur (stroom @ 60%)	A	65
Maximum inschakelduur	A	115@20%
Lastype	MIG-MAG-FLUX	
Gewicht	kg	11,00
Afmetingen (l x b x h)	mm	800 x 450 x 570
Prijs	€	543,00



TECHNOMIG 180

TECHNOMIG 180-EU

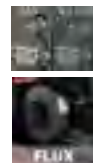

Inverter halfautomaat voor MIG-MAG, FLUX en brazeren-hardsolderen.

Veelzijdig lastoestel met breed toepassingsveld voor het lassen van staal, alu, inox en brazeren -hardsolderen van verzinkt staal, koper, zink, ...

Kenmerken:

- Synergische instelling van de materiaaldikte voor snel en gemakkelijk lassen met optimale lasparameters, met manueel regeling van de lasdikte.
- Zeer compact en licht toestel. Thermische beveiliging en beveiliging tegen overspanning en onderspanning (max +/-15%).

TECHNOMIG180-EU: geleverd met loskoppelbare **euroconnector lastoorts**.

Geleverd met lastoorts 2,5m, laskit voor staal en gasontspanner.
Optioneel : trolley voor gemakkelijk transport, laskits voor alu of inox.

Order nr.	830816051 E	830816054 E
Orig. nr.	TECHNOMIG180	TECHNOMIG180-EU
Spanning	V	230
Inschakelduur (stroom @ 60%)	A	80
Regelbereik	A	30-170
Opgenomen vermogen 60%/maximum	kW	1,6/3,8
Opgenomen stroom 60%/maximum	A	12/24
Nullastspanning	V	62
Krachtfactor	cos fi	0,86/0,7
Beschermingsklasse	IP	23
Capaciteit staal lasdraad	mm	0,6/0,8
Capaciteit inox lasdraad	mm	0,8
Capaciteit alu lasdraad	mm	0,8/1
Capaciteit gevulde lasdraad	mm	0,8/1,2
Braseerdraad	mm	0,8
Geschikt voor staal		✓
Geschikt voor RVS		✓
Geschikt voor alu		✓
Geschikt voor lassen zonder gas		✓
Geschikt voor braseren		✓
Mobiel		✓
Maximum inschakelduur	A	140@20%
Lastype	MIG-MAG-FLUX	MIG-MAG-FLUX
Gewicht	kg	11,00
Afmetingen (l x b x h)	mm	800 x 450 x 570
Prijs	€	679,00

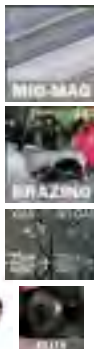

Draagbare inverter halfautomaat voor MIG-MAG lassen, FLUX (zonder gas) en brazeren-hardsolderen. Veelzijdig lastoestel met breed toepassingsveld voor het lassen van staal, alu, inox en brazeren -hardsolderen van verzinkt staal, koper, zink, ...

Kenmerken:

- **Digitaal display** met snelle en gemakkelijke synergetische instelling van de correcte lasparameters met de ONE TOUCH LCD technologie.
- Euroconnector lastoorts maakt het mogelijk snel van toorts en te verlossen materiaal te verwisselen.
- **17 synergetische lascurves in geheugen.**
- Manuele selectie van materiaaldikte, draaddikte en gastype geven een optimale synergetische keuze van lasstroom en -spanning. Lasstroom, draadsnelheid en lasvorm gemakkelijk manueel bijregelbaar afhankelijk van de voorkeuren van de lasser.
- Regelbare parameters: lasstroom, draaddikte, draadsnelheid, reactantie, draadversnelling, burn-back, post gaz en selectie 2 of 4-takt
- Zeer compact en licht toestel.
- Thermische beveiliging en beveiliging tegen overspanning en onderspanning (max +15%).

Geleverd met lastoorts 3m, laskit voor staal en gasontspanner. Optioneel: trolley voor gemakkelijk transport, laskits voor alu of inox.

Order nr.	830816052 €	
Orig. nr.	TECHNOMIG210	
Spanning	V	230
Inschakelduur (stroom @ 60%)	A	105
Inschakelduur I _{max}	A @ %	180/20
Regelbereik	A	20-200
Opgenomen vermogen 60%/maximum	kW	2.5/5
Opgenomen stroom 60%/maximum	A	15/30
Nullastspanning	V	62
Kranchfactor	cos fi	0.7
Beschermingsklasse	IP	IP23
Bobijn maximum	kg/mm	5/200
Capaciteit staal lasdraad	mm	0.6-1
Capaciteit inox lasdraad	mm	0.8
Capaciteit alu lasdraad	mm	0.8-1
Capaciteit gevulde lasdraad	mm	0.8-1.2
Braseerdraad	mm	0.8
Lastype	MIG-MAG-FLUX	
Gewicht	kg	12,50
Afmetingen (l x b x h)	mm	800 x 450 x 570
Prijs	€	879,00

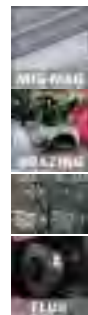
**NEW**

Inverter halfautomaat voor MIG-MAG lassen, FLUX (zonder gas), brazeren-hardsolderen en optioneel TIG (LIFT) lassen.

Voordelen:

- **Full digitaal display** met snelle en gemakkelijke synergetische instelling van de correcte lasparameters met de ONE TOUCH LCD technologie
- Veelzijdig lastoestel met breed toepassingsveld voor het lassen van staal, alu, inox en brazeren -hardsolderen van verzinkt staal, koper, zink, ...
- Euroconnector lastoorts maakt het mogelijk snel van toorts en te verlossen materiaal te verwisselen.

Kenmerken:

- **17 synergetische lascurves in geheugen.**
- Manuele selectie van materiaaldikte, draaddikte en gastype geven een optimale synergetische keuze van lasstroom en -spanning. Lasstroom, draadsnelheid en lasvorm gemakkelijk manueel bijregelbaar afhankelijk van de voorkeuren van de lasser.
- Regelbare parameters: lasstroom, draaddikte, draadsnelheid, reactantie, draadversnelling, burn-back, post gaz en selectie 2 of 4-takt.
- Met wielbasis en opzetplaat voor gasflus.
- Ruimte omkasting met **15kg bobijn capaciteit.**
- Thermische beveiliging en beveiliging tegen overspanning en onderspanning (max +15%).

Geleverd met lastoorts 3m, laskit voor staal en gasontspanner. Optioneel TIG(LIFT) lassen mogelijk met de voorziene DX-klemmen.

Optioneel: trolley voor gemakkelijk transport, laskits voor alu of inox.

Order nr.	830816053 €	
Orig. nr.	TECHNOMIG215	
Spanning	V	230
Inschakelduur (stroom @ 60%)	A	105
Regelbereik	A	20-220
Opgenomen vermogen 60%/maximum	kW	2.6/5.2
Opgenomen stroom 60%/maximum	A	16/31
Nullastspanning	V	62
Bobijn maximum	kg/mm	15/300
Efficiëntie	%	86
Kranchfactor	cos fi	0.7
Beschermingsklasse	IP	IP23
Capaciteit staal lasdraad	mm	0.6-1
Capaciteit inox lasdraad	mm	0.8
Capaciteit alu lasdraad	mm	0.8-1
Gewicht	kg	11,00
Afmetingen (l x b x h)	mm	800 x 450 x 570
Prijs	€	1.038,00



Inverter halfautomaat voor MIG-MAG lassen, brazeren-hardsolderen, FLUX (zonder gas), en optioneel TIG (LIFT) lassen.

Voordelen:

- **Digitaal display** met snelle en gemakkelijke synergetische instelling van de correcte lasparameters met de ONE TOUCH LCD technologie
- Veelzijdig lastoestel met breed toepassingsveld voor het lassen van staal, alu, inox en brazeren-hardsolderen van verzinkt staal, koper, zink, ...
- Euroconnector lastoorts maakt het mogelijk snel van toorts en te verlassen materiaal te verwisselen.

Kenmerken:

- **17 synergetische lascurves in geheugen.**
- Manuele selectie van materiaaldikte, draaddikte en gastype geven een optimale synergetische keuze van lastroom en -spanning. Lastroom, draadsnelheid en lasvorm gemakkelijk manueel bijregelbaar afhankelijk van de voorkeuren van de lasser.
- Regelbare parameters: lasstroom, draaddikte, draadsnelheid, reactantie, draadversnelling, burn-back, post gaz en selectie 2 of 4-takt.
- Met wielbasis en opzetplaat voor gasflus.
- Ruimte omkasting met **15kg bobijn capaciteit.**
- Thermische beveiliging en beveiliging tegen overspanning en onderspanning (max +15%).

Geleverd met lastoorts 3m, euroconnector laskit voor staal en gasontspanner.

Optioneel: trolley voor gemakkelijk transport, laskits voor alu of inox.

Optioneel TIG(LIFT) lassen mogelijk met de voorziene DX-klemmen.

Order nr.	830816059 €	
Orig. nr.	ELECTROMIG220	
Spanning	V	3x400
Inschakelduur (stroom @ 60%)	A	105
Inschakelduur Imax	A @ %	200 @ 25%
Regelbereik	A	20-230
Capaciteit elektroden	mm	1,6/4
Opgenomen vermogen 60%/maximum	kW	3,5/7,2
Nullastspanning	V	75
Kranchfactor	cos fi	0,8
Beschermingsklasse	IP	23
Capaciteit staal lasdraad	mm	0,6/1
Capaciteit inox lasdraad	mm	0,8/1
Capaciteit alu lasdraad	mm	0,8/1
Isolatieklasse	H	
Gewicht	kg	23,00
Prijs	€	1.565,00



MIG-MAG en FLUX halfautomaten op wielen.

Voordelen:

- Zowel lassen met gas als flux lassen zonder gas is mogelijk met deze toestellen.
- Standaard uitgerust voor het FLUX-lassen zonder beschermgas met gevulde lasdraad.
- Ventilatorgekoeld en met thermische bescherming.

Geleverd met rolletje FLUX-draad en met wielen.

Optioneel: MIG-MAG lassen met gas is mogelijk via de optionele laskits voor staal, inox of alu.

Order nr.	830821011 €	
Orig. nr.	BIMAX 152 TURBO	
Spanning	V	230
Inschakelduur (stroom @ 60%)	A	55
Inschakelduur Imax	A @ %	115 @ 15%
Regelbereik	A	30-145
Opgenomen vermogen 60%/maximum	kW	1,4/3,7
Nullastspanning	V	31
Kranchfactor	cos fi	0,9
Beschermingsklasse	IP	21
Bobijn maximum	kg/mm	5/200
Capaciteit staal lasdraad	mm	0,6-0,8
Capaciteit inox lasdraad	mm	0,8
Capaciteit alu lasdraad	mm	0,8-1
Capaciteit gevulde lasdraad	mm	0,8-1,2
Geschikt voor staal		✓
Geschikt voor RVS		✓
Geschikt voor alu		✓
Geschikt voor lassen zonder gas		✓
Mobiel		✓
Lastype		MIG-MAG-FLUX
Gewicht	kg	23,30
Afmetingen (l x b x h)	mm	730 x 370 x 475
Prijs	€	424,00

Accessoires MIG-MAG



MIG-MAG en FLUX halfautomaten op wielen.

Kenmerken:

- Zowel lassen met gas als flux lassen zonder gas is mogelijk met deze toestellen.
- Standaard uitgerust voor het FLUX-lassen zonder beschermgas met gevulde lasdraad.
- Ventilatorgekoeld en met thermische bescherming.

MIG-MAG lassen met gas is mogelijk via de optionele laskits voor staal, inox of alu.

Geleverd met rolletje FLUX-draad, wielen en metaalplaat om gasfles te vervoeren.

Order nr.		830821012 E
Orig. nr.		BIMAX 162 TURBO
Spanning	V	230
Inschakelduur (stroom @ 60%)	A	55
Regelbereik	A	30-145
Opgenomen vermogen 60%/maximum	kW	1,4/3,7
Nullastspanning	V	31
Krachtfactor	cos fi	0,9
Beschermingsklasse	IP	21
Bobijn maximum	kg/mm	5/200
Mobiel		✓
Inschakelduur (stroom @ 60%)	A	55
Maximum inschakelduur	A	15% @ 115
Staal lasdraad	mm	0,6-0,8
Inox lasdraad	mm	0,8
Alu lasdraad	mm	0,8-1
Gevulde lasdraad	mm	0,8-1,2
Regelstanden		4
Zekering op het net		16
Isolatieklasse		H
Lastype		MIG-MAG-FLUX
Gewicht	kg	24,80
Afmetingen (l x b x h)	mm	640 x 350 x 470
Prijs	€	464,00



Lasset MIG-MAG voor het lassen van staal, inox, RVS.

Order nr.	Voor type	Laskit	Diameter rol mm	Prijs €
830802147 E	Bimax 152, 162, 182	staal - wegwerpfles	0,6 - 0,8	56,90
830802148 E	Bimax 152, 162, 182	staal - hervulbare fles	0,6 - 0,8	73,90
830802036 E	Bimax, Telmig 150/1, 170, 180/2	alu (zonder draad-geleider)	0,8 - 1,0	58,90
830802037 E	Bimax Telmig / Digital Mig / d vol	inox	0,6 - 0,8	52,50
830802115 E	Telmig 200/2, 251/2, 281/2 / Digital Mig 180	aluminium	1	99,90
830802273 E	Mastermig 300, 400, 500	aluminium	1-1,6	171,00



Lasset MIG-MAG voor het lassen van aluminium.

Order nr.	Prijs €
830802766 E	72,90



MIG/MAG lastoortsen voor Telwin, MWMACH en Metalworks halfautomaten.

Order nr.	Voor type	Lengte m	Ampère maximum A	Aansluiting	Prijs €
830742901 E	Telmig 150/1	2	160	intern	63,90
830742402 E	Bimax 152,162, Technomig 150 dual	2	160	intern	69,90
830742405 E	Telmig 180/2 en 170/1	2,5	180	intern	80,50
830742082 E	Bimax 182 / Technomig 180 DUAL	2,5	180	intern	94,50
830742180 E	Telmig 200/2, 251/2, technomig 210, 215 dual en Metalworks Premium Mig 160	3	220	euro	101,00
830742181 E	Telmig 200/2, 251/2, technomig 210, 215 dual en Metalworks Premium Mig 160	4	220	euro	112,00
830742182 E	Digital Mig 220	5	220	euro	132,00
830742183 E	Telmig 281/2, Mastermig 270/2, 300	3	270	euro	114,00
830742184 E	Telmig 281/2, Mastermig 270/2, 300	4	270	euro	136,00
830742185 E	Telmig 281/2, Mastermig 270/2, 300	5	270	euro	160,00
830742186 E	Mastermig 400, Inverpulse 320, Digital Supermig 360	3	400	euro	157,00
830742187 E	Mastermig 400, Inverpulse 320, Digital Supermig 360	4	400	euro	184,00
830742188 E	Mastermig 400, Inverpulse 320, Digital Supermig 360	5	400	euro	213,00
830722798 E	Digital Supermig 460, 560, Inverpulse 420	3	500	euro	334,00
830722800 E	Digital Supermig 460, 560, Inverpulse 420	5	500	euro	410,00
829300184 E	MIG160E - MIG200E				50,00



Lasstips voor Telwin, MWMACH en Metalwoks toestellen. Besteleenheid : per 20 stuks.

Order nr.	Voor type	Diame-ter	Omschrijving	VE	Min. bestelhoeveelheid	Prijs/VE
		mm				€
830722415	Bimax, Telmig, Digital MIG, Technomig, Metalworks Premium MIG 160	0,6	staal	1	20	1,10
830722416	Bimax, Telmig, Digital MIG, Technomig, Metalworks Premium MIG 160	0,8	staal	1	20	1,10
830722680	Mastermig, Telmig 281/2	0,8	staal	1	20	2,20
830722705	Telmig 200/2, 251/2, Digital Mig 220	1,0	staal	1	20	1,50
830722681	Mastermig, Digital supermig 360	1,0	staal	1	20	2,20
830722682	Mastermig, Digital supermig 360	1,2	staal	1	20	2,90
830722797	Mastermig 400	1,6	staal	1	20	2,20
830722556	Bimax, Telmig, Mastermig, Digital Mig, Technomig	0,8	aluminium	1	20	3,00
830722552	Bimax, Telmig, Mastermig, Digital Mig, Technomig	1,0	FLUX / aluminium	1	20	3,00
830722553	Bimax, Telmig, Mastermig, Digital Mig, Technomig	1,2	flux	1	20	3,00
830722818	Mastermig 400, Digital supermig 360	1,6	aluminium	1	20	2,90



Lasbekken met cilindrische bek voor MIG/MAG apparaten van Telwin, MWMACH en Metalwoks lasapparaten

Order nr.	830722149	830722684
Voor type	Bimax, Telmig, Digital Mig, Technomig dual	Telmig 281/2, Mastermig 270/2, 300
Omschrijving	cilindrische bek - 16mm (4)	cilindrische bek - 18mm (4)
VE	1	1
Min. bestelhoeveelheid	10	10
Prijs/VE	€ 4,60	6,40



Lasbekken met versmalde hals voor MIG/MAG. Passend voor Telwin, Metalworks, MW MACH

Order nr.	830722151	830722686	830722793
Voor type	Bimax, Telmig, Digital Mig, Technomig Dual	Telmig 281/2, Mastermig 270/2, 300	Mastermig 400, Digital supermig 360
Omschrijving	bek met versmalde hals (5)	bek met versmalde hals (5)	bek met versmalde hals (5)
Prijs	€ 13,90	11,90	17,50



Lasbekken met conische bek voor MIG/MAG apparaten van Telwin, Metalworks en MWMACH

Order nr.	830722423	830722685	830722792
Voor type	Bimax, Telmig, Digital Mig, Technomig dual, Metalworks Premium MIG 160	Telmig 281/2, Mastermig 270/2, 300	Mastermig 400, Digital supermig 360
Omschrijving	conische bek	conische bek	conische bek
VE	1	1	1
Min. bestelhoeveelheid	10	10	10
Prijs/VE	€ 5,50	5,90	13,50



Draadgeleiders voor toorts

Order nr.	Voor type	Diameter mm	Lengte m	Prijs €
830722077	Bimax 152,162, Technomig 150 dual	0,6-0,8	3	5,20
830742412	Telmig 150/1	0,6-0,8	3	5,20
830722437	Telmig 200/2, 251/2, 281/2, Technomig 210,215 dual Digital Mig, Mastermig, Premium MIG 160	0,6-0,8	3	8,10
830742413	Telmig 180/2, 170/1	0,6-0,8	3	4,20
830742422	Bimax 182, Technomig 180 dual	0,6-0,8	3	6,40
830722795	Mastermig 400	1,2-1,6	3	12,50
830722689	Telmig 200/2, 251/2, 281/2, Technomig 210,215 dual, Digital Mig, Mastermig, Premium MIG 160	1,0-1,2	3	10,90
830722516	Telmig 200/2, 251/2, 281/2, Technomig 210,215 dual, Digital Mig, 1,0-1,2 ALU	1,0-1,2 ALU	3	48,50
830722597	Mastermig, Premium MIG 160	1,2-1,6 ALU	3	39,50



Set gasregelaar voor wegwerpflessen

Geschikt voor:

- Argon of menggas.
- MIG/MAG en TIG lassen.

Kenmerken:

- Schroefdraad aansluiting voor wegwerpflessen.

Geleverd met:

- Gas slang en slangklemmen

Geleverd zonder manometer

Order nr.	830802032
Omschrijving	wegwerpfles
Prijs	€ 35,90



Set gasregelaar voor navulbare industriële gasflessen met gas slang en slangklemmen

Geschikt voor:

- Argon of menggas.
- MIG/MAG en TIG lassen.

Geleverd zonder manometer

Order nr.	830802708 €
Omschrijving	hervulbare fles (België)
Prijs	€ 52,50



Gasregelaar voor hervulbare flessen.

Gasregelaar zonder manometer voor Argon of menggas. Geschikt voor MIG/MAG en TIG lassen.

Schroefdraad aansluiting voor Belgische of Nederlandse gasflessen.

Optie: Adapter voor Nederlandse gasflessen: 830432160.

Order nr.	830722341 €	830722343 €
Voor type	hervulbare flessen (België)	hervulbare flessen (NL)
Prijs	€ 39,50	46,90



Gasregelaar voor wegwerpflessen.

Gasregelaar zonder manometer voor Argon of menggas. Geschikt voor MIG/MAG en TIG lassen.

Schroefdraad aansluiting voor Belgische gasflessen.

Optie: Adapter voor Nederlandse gasflessen: 830432160.

Order nr.	830722120 €
Voor type	wegwerpflessen
Prijs	€ 29,90



België
Nederland



België
(industriëel)

Gasregelaar voor navulbare gasflessen.

Gasregelaar met dubbele manometer voor Argon of menggas. Geschikt voor MIG/MAG en TIG lassen.

Schroefdraad aansluiting voor Belgische of Nederlandse gasflessen.

Optie: adapter voor Nederlandse gasflessen: 830432160.

Type 830722346 in industriële uitvoering.

Order nr.	830722119 €	830722121 €	830722346 €
Type	België	Nederland	België (industriëel)
Prijs	€ 58,90	67,90	96,50



Gasfles adaptor voor aansluiten van gasregelaars voor Nederlandse flessen.

Order nr.	830432160 €
Voor type	hervulbare flessen
Prijs	€ 9,30



Lasset voor aluminium, voor maten 0,8 en 1 mm.

Order nr.	830802817 €
Voor type	Technomig 215 - Electromig 220
Prijs	€ 88,00

TIG lasapparaten



Draagbaar TIG inverter lasapparaat, voor TIG en MMA lassen in gelijkstroom (DC) met HF-boog (hoge frequentie) of LIFT.

Kenmerken:

- Arc force
- 2/4 takt
- Hot start en anti-stick
- Automatische controle bij het opstarten
- Thermische beveiliging en beveiliging tegen overspanning en onderspanning.

Geslacht voor:

- Lassen met staal, inox, titanium, koper, nikkel en hun legeringen.

Niet geschikt voor aluminium lassen in TIG.

Geleverd met TIG laskit. Voorzien voor afstandsbediening.

Order nr.	830815957	
Orig. nr.	TTIG 160DC-HF/LIFT	
Spanning	V	230
Inschakelduur (stroom @ 60%)	A	75
Maximum inschakelduur	A	130 @ 15%
Regelbereik	A	5-130
Opgenomen vermogen 60%/maximum	kW	1,7/3,7
Opgenomen stroom 60%/maximum	A	13/25
Nullastspanning	V	93
Kranchfactor	cos fi	0,6
Rendement	eta	0,8
Isolatieklasse	H	
Beschermingsklasse	IP	21
Rutiel elektroden	mm	✓
Basische elektroden	mm	✓
Elektroden voor inox en gietijzer	mm	✓
Lastype	TIG	
Gewicht	kg	10,00
Afmetingen (l x b x h)	mm	335 x 130 x 230
Prijs	€	975,00



Draagbaar TIG inverter lasapparaat, voor TIG en MMA lassen in gelijkstroom (DC) met HF-boog (hoge frequentie) of LIFT.

Kenmerken:

- Instelbare parameters: arc force, 2/4 takt. Hot start en anti-stick, bilevel, optionele pulse.
- Voorzien voor afstandsbediening.
- Automatische controle bij het opstarten.
- Thermische beveiliging en beveiliging tegen overspanning en onderspanning.

Geslacht voor:

- Lassen met staal, inox, titanium, koper, nikkel en hun legeringen.
- Bruikbare elektrodes in MMA: basische elektrodes, rutiel, inox, gietijzer.

Niet geschikt voor aluminium lassen in TIG.

Geleverd met TIG-toorts, gasontspanner met dubbele manometer en massaklem.

Order nr.	830815038	
Orig. nr.	TTIG230DC-HF/LIFT	
Spanning	V	230
Inschakelduur (stroom @ 60%)	A	125
Maximum inschakelduur	A	220 @ 30%
Regelbereik	A	5-220
Opgenomen vermogen 60%/maximum	kW	3,6/5,5
Opgenomen stroom 60%/maximum	A	24/33
Nullastspanning	V	87
Kranchfactor	cos fi	0,6
Rendement	eta	0,83
Isolatieklasse	H	
Beschermingsklasse	IP	23
Rutiel elektroden	mm	✓
Basische elektroden	mm	✓
Elektroden voor inox en gietijzer	mm	✓
Lastype	TIG	
Gewicht	kg	8,50
Afmetingen (l x b x h)	mm	385 x 150 x 360
Prijs	€	1.019,00



TTIG222AC/DC-HF/LIFT

TTIG182AC/DC-HF/LIFT



Draagbaar TIG invertor lasapparaat voor lassen in wisselstroom AC en DC gelijkstroom. Met koelventilator, gestuurd door microprocessor, PULSE TIG, en MMA lassen met de mogelijkheid tot HF-boog (hoge frequentie) of LIFT.

Kenmerken:

- Instelbare parameters: Post gas, down slope, bi-level, arc-force.
- 2/4 takt.
- Beschikt over hot start en anti-stick.
- Voorziening voor afstandsbediening.
- Thermische beveiliging en beveiliging tegen overspanning, onderspanning en overbelasting.

Geschikt voor:

- Lassen met staal, inox, ALUMINIUM, titanium, koper, nikkel, magnesium en hun legeringen.
- Bruikbare elektrodes in MMA: basische elektrodes, rutiel, inox, gietijzer.

Geleverd met TIG-toorts, gasontspanner met dubbele manometer en massaklem.

Order nr.	830815332	830815476
Orig. nr.	TTIG182AC/DC- HF/LIFT	TTIG222AC/DC- HF/LIFT
Spanning	V 230	230
Inschakelduur (stroom @ 60%)	A 85	100
Maximum inschakelduur	A 160 @ 20%	200 @ 24%
Regelbereik	A 5-160	5-200
Opgenomen vermogen 60%/maximum	kW 2,5/4,3	3/5,5
Opgenomen stroom 60%/maximum	A 18/29	20/34
Nullastspanning	V 94	100
Kranchfactor	cos fi 0,7	0,6
Rendement	eta 0,75	0,77
Isolatieklasse		H
Beschermingsklasse	IP 23	23
Inschakelduur I _{max}	A @ % 160 @ 20%	
Capaciteit elektroden	mm 5-160	
Geschikt voor alu	✓	✓
Mobiel	✓	✓
Rutiel elektroden	mm ✓	✓
Basische elektroden	mm ✓	✓
Elektroden voor inox en gietijzer	mm ✓	✓
Lastype	TIG	TIG
Gewicht	kg 9,70	12,80
Afmetingen (l x b x h)	mm 430 x 170 x 340	430 x 170 x 340
Prijs	€ 1.625,00	2.165,00



PERFECTE LASNADEN



TIG-Cleaning set "Cleantech 100" voor het nabehandelen van lasnaden.

Kenmerken:

- Inwerking van hitte, vlamboog en andere materiaal aantasting worden moeiteloos weggewerkt tot een prachtig eindresultaat.
- Snelle en mooie reiniging.

Geschikt voor:

- Uiterst geschikt voor het reinigen van TIG en MIG lasnaden op roestvrij staal.

Geleverd in koffer met generator, toorts, vezelstrip kit, reinigingsvloeistof en verdeelkan.

Order nr.	830850000
Orig. nr.	850000
Frequentie	Hz 50-60
Spanning	V 230
Aantal standen	2
Gewicht	kg 14,40
Afmetingen (l x b x h)	mm 34.5 x 21.5 x 28
Prijs	€ 349,00



Slijptoestel voor TIG elektrodes. Voor het slijpen van TIG elektroden Ø 1,0 tot 4,0mm.

Voordelen:

- Geslepen elektrodes zorgen voor een stabiele vlamboog en optimale lasresultaten.
- Minimaal materiaalverlies van slechts 0,3mm.
- Elektroden tot 200x slijpbaar in plaats van 50 -100x met de hand.

Kenmerken:

- Slijphoek traploos instelbaar van 15°-180°.
- Korte elektroden tot 15mm nog slijpbaar (bijvoorbeeld voor rondlassen).
- Verhit of brandt de elektrodes niet uit.
- **Geïntegreerde afzuiging met P3 stoffilter voorkomt inademen van stofdeeltjes.**
- Precieze en stevige klemming van de elektrode, voor een optimale veiligheid.
- Met zichtvenster ter controle van het slijpproces.
- Diamantsteen met 3 niveaus, dus 3 keer langere standtijd.
- Las- of metaaldruppels op de elektrode worden eenvoudig mee weggeslepen.
- Sterke 850W motor.

Geleverd met:

- Slijpkop met filterbehuizing en filter.
- Elektrodehouder.
- Diamantschijf Ø 40 mm.
- Spantangen voor Elektrodes 1,6/2,4/3,2 mm.
- Gereedschap
 - 2 xinbusleutel 8/4 mm,
 - 2 x steeksleutel 13-17 / 13-14.
- Kunststof koffer.

Order nr.	711690100 €		
Orig. nr.		1690100	
Spanning	V	230	
Toerental	min-1	8.000-32.000	
Vermogen motor	W	850	
Instelbare slijphoek	°	15-180	
lengte elektrode	mm	min. 15	
Elektrode diameter	mm	1.0-4.0	
Diamantschijf	mm	Ø 40	
Gewicht	kg	2,50	
Prijs	€	875,00	

Accessoires TIG

MACH

Laswagen. Laag model.

NEW



Kenmerken:

- Stevige plaatstalen constructie
- Laag model geschikt voor grotere apparaten
- Legbord onderaan: ruimte voor toortsen of laskap
- Gasfleshouder met twee kettingen
- Maximum laadcapaciteit: 50 kg
- Twee zwenkwielen aan de voorkant
- Grote vaste wielen achteraan

Order nr.	754751583 €		
Orig. nr.		LKA500	
Capaciteit	kg	50	
Afmetingen bovenplaat	mm	500x315	
Gewicht	kg	11,50	
Afmetingen (l x b x h)	mm	730 x 450 x 860	
Prijs	€	69,00	

MACH

Laswagen. Hoog model.



Kenmerken:

- Plaatstalen constructie
- Gekanteld bovenblad voor gemakkelijke bediening
- Twee legborden onderaan: ruimte voor toortsen of laskap
- Gasfleshouder met twee kettingen
- Maximum laadcapaciteit: 50 kg.
- Twee zwenkwielen aan de voorkant.
- Grote vaste wielen aan de achterkant.

Order nr.	754751581 €		
Orig. nr.		LKA700	
Capaciteit	kg	45	
Afmetingen bovenplaat	mm	430x290	
Gewicht	kg	11,00	
Afmetingen (l x b x h)	mm	700 x 420 x 775	
Prijs	€	79,90	

MACH

Laswagen met lades. Zwaar model.

NEW



Kenmerken:

- Stalen constructie, gemonteerd geleverd
- Groot bovenvlak voor MIG/TIG lastoestellen
- 4 lades voor optimaal opbergen
- Gasfleshouder met twee kettingen
- 2 zijhaken voor kabels en toorts
- Maximum laadcapaciteit: 70 kg
- Twee zwenkwielen aan de voorkant
- Grote vaste wielen aan de achterkant

Order nr.	754751585 €		
Orig. nr.		LKA800	
Capaciteit	kg	70	
Afmetingen bovenplaat	mm	502x350	
Gewicht	kg	38,00	
Afmetingen (l x b x h)	mm	585 x 420 x 780	
Prijs	€	199,00	



Complete lassets TIG

Order nr.	Voor type	Type	Prijs €
830801097	Tecnica 114, 164, 150, 168 GE Technology 175, 210, 220/S, 228CE/GE (Zonder HF) PREMIUM 170, MIG 160	ST9V	182,00
830802415	Tecnica TIG 155 / TIG 160 / Technology TIG 182, 185	ST17	215,00
830802489	Technology Tig 230	ST26	276,00
830802607	Technology Tig 222	ST26	276,00



Tig toortsen voor Telwin en Metalworks.

Order nr.	Omschrijving	Voor type	Lengte tip m	DX	Prijs €
830722563	toorts ST9V	zonder Hf: Tecnica, Technology, Metalworks TEC / Premium	4	25	108,00
830742058		Superior 260 CE (zonder HF)	4	50	134,00
830742423	toorts ST17	Tecnica Tig 155, Technology Tig 230	4	25	122,00
830742424		Technology Tig 172, 180	4	50	124,00
830742427	toorts ST26	Superior 300 CE, Inverpulse 420 (zonder HF)	4	50	158,00
830742431		Superior 300 CE, Inverpulse 420 (zonder HF)	8	50	224,00



VOOR TELWIN
EN MW-MACH

TIG Accessoires - Keramische bek

Order nr.	Omschrijving	Diameter nr	VE	Prijs/VE €
830802244	keramische bek	4	10	10,90
830802245	keramische bek	6	10	10,90
830802246	keramische bek	7	10	10,90
830802247	keramische bek	8	10	10,90
830802248	keramische bek	9	10	10,90



TIG Accessoires - Electrodes Wolfram

VOOR TELWIN
EN MW-MACH

Order nr.	Omschrijving	VE	Prijs/VE €
830802234	AC, groene Wolfram elektrodes 1,0	10	19,50
830802235	AC, groene Wolfram elektrodes 1,6	10	36,90
830802236	AC, groene Wolfram elektrodes 2,4	10	82,50
830802237	AC, groene Wolfram elektrodes 3,2	10	147,00
830802238	AC, groene Wolfram elektrodes 4,0	10	233,00



TIG Accessoires - Electrodes Cerium Tungsten

VOOR TELWIN
EN MW-MACH

Order nr.	Omschrijving	VE	Prijs/VE €
830802220	DC, grijze Cerium-Tungsten elektrodes 1,0	10	21,50
830802222	DC, grijze Cerium-Tungsten elektrodes 1,6	10	35,90
830802232	DC, grijze Cerium-Tungsten elektrodes 2,4	10	72,90
830802233	DC, grijze Cerium-Tungsten elektrodes 3,2	10	123,00



Accessoires voor Telwin TIG-Cleaning set "Clean Tech"

Order nr.	830322905	830980320	830742384
Omschrijving	Cleantech vloeistof 3l	Cleantech strips (10 stuks)	reinigingskop Cleantech 100
Prijs	€ 28,50	39,50	26,50



VOOR TELWIN
EN MW-MACH

TIG Accessoires - Electrodehouders

Order nr.	Omschrijving	VE	Prijs/VE €
830802239	electrode houders 1,0	3	4,10
830802240	electrode houders 1,6	3	4,10
830802241	electrode houders 2,4	3	4,10
830802242	electrode houders 3,2	3	4,10
830802243	electrode houders 4,0	3	4,10



VOOR TELWIN
EN MW-MACH

TIG Accessoires - Electrode diffusor

Order nr.	Omschrijving	VE	Prijs/VE €
830802249	gasdiffusor 1,0	3	8,20
830802250	gasdiffusor 1,6	3	8,20
830802251	gasdiffusor 2,4	3	8,20
830802252	gasdiffusor 3,2	3	8,20
830802253	gasdiffusor 4,0	3	8,20

Verbruiksartikelen



Rutel gecoate laselektroden voor staal

Geslacht voor:

- ongelegeerd staal
- tot 38kg/mm² treksterkte.
- Voor industrie, handwerk en assemblage.

Kenmerken:

- Lassen in de meeste lasposities.
- Gemakkelijk opstarten
- Stabiele vlamboog
- Weinig spatten.
- Gemakkelijk verwijderbare slak.
- Treksterkte las : 48 kg/mm².
- Klasse: AWS A5.1:E6013.

Order nr.	830802737	830802739	830802749
Voor type	MMA	MMA	MMA
Diameter mm	2x300	2,5x300	3,2x300
Gewicht kg	2,50	2,50	5,00
Prijs €	12,50	10,50	18,50



Basisch gecoate laselektrodes E7018 voor staal met zeer goed mechanische eigenschappen

Geslacht voor:

- ongelegeerd staal tot 42 kg/mm² treksterkte.
- Hogekwaliteitslassen met goeie sterkte en hardheid.
- voor tanks of drukvaten
- Staal toegepast in hoge of lage temperatuur
- Onzuiver staal en staal met hoger koolstofgehalte.
- Voor lassen in de meeste lasposities.

Kenmerken:

- Hoge treksterkte las : 56 kg/mm².
- Klasse: AWSa5.1:E7018.

Order nr.	830802748	830802765
Voor type	MMA	MMA
Diameter mm	2,5x300	3,2x350
Gewicht kg	2,50	5,10
Prijs €	13,50	24,90



Rutel beklede elektrode R43 voor staal.

Geslacht voor:

- Universeel lassen van ongelegeerd staal.
- Ideaal bij verticaal lassen en verticaal opgaand lassen.

Kenmerken:

- De elektrode is zeer eenvoudig in gebruik, ook voor onervaren lassers.
- Lasstroom: AC/DC-
- Klasse: EN ISO 2560 A:E 42 0 RR12 en AWS A5.1:E. 6013
- Metaal uitwisseling: 95%
- C: 0.08
- Si: 0.35
- Mn: 0.5
- Maximum reksterkte R(e): 420-510 N/mm²
- Treksterkte R(m): 510-640
- Uitbreiding A(5): 22%
- Impactsterkte KV: 0%C. > 47J.

Prijs per pak.

Order nr.	Diameter mm	Lengte mm	Lasstroom A	Voor type	Gewicht kg	Prijs €
205930100	2	300	50-70	MMA	1,00	8,10
205930308	2,5	350	65-90	MMA	3,00	22,50
205930407	3,2	350	100-140	MMA	2,70	17,50
205930506	4,0	450	140-180	MMA	6,00	36,90



Rutel beklede elektrode R44S voor staal

Geslacht voor:

- Universeel lassen van ongelegeerd staal.
- Lassen in alle posities, alsook boven het hoofd en verticaal neerwaarts.
- Tolerant voor variërende oppervlakken, en uitstekend voor het dichtmaken van grote openingen.

Kenmerken:

- Lasstroom: AC/DC-
- Klasse: EN ISO 2560 A:E 38 0 RC 11 en AWS A5.1: E 6012
- Metaal uitwisseling: 95%
- C: 0.12
- Si: 0.6
- Mn: 0.5
- Maximum reksterkte R(e): 470 N/mm²
- Treksterkte R(m): 550 N/mm²
- Uitbreiding A(5): 23%
- Impactsterkte KV: 0%C. > 56J.

Prijs per pak.

Order nr.	205940208	205940307
Diameter mm	2,5	3,2
Lengte mm	350	350
Lasstroom A	70-90	95-130
Voor type	MMA	MMA
Gewicht kg	2,80	2,70
Prijs €	19,50	15,90



"RMA MIX 18" Rutiel inox elektrode met 6% Mn legering.

Geschikt voor:

- Lassen in 13% Mn staal, gehard staal en andere types staal die moeilijk te lassen zijn.
- Ook geschikt om getemperd staal en inox te verlassen zonder vooraf te verhitten.

Kenmerken:

- Hardheid van de las: van 200 HV tot 450HV.
- Lasstroom: AC/DC+
- Klasse: EN1600: E18 8 Mn R53 en AWS A 5.4 :E: 307 - 26
- Metaal uitwisseling: 95%
- Maximum reksterkte R(p) 0.2%: 425 N/mm²
- Treksterkte R(m): 650 N/mm²
- Uitbreiding: 35%

Toepassingen:

- Buffer lagen onder de bovenste laag van RMA H100 op de plaat van verbrijzelaars en zware werfmachines, rails, rail wissels, treinwielen en kraanwielen van Mn staal.

Geleverd in pvc doos.

Order nr.		206240103 €	206240202 €
Diameter	mm	2,5	3,2
Leugte	mm	350	350
Lasstroom	A	80-100	110-150
Voor type		MMA	MMA
Gewicht	kg	1,00	1,00
Prijs	€	36,90	29,90



Basisch beklede elektrode R48S voor staal.
voor lassen met verhoogde mechanische sterkte

Geschikt voor

- Het lassen van ongelegeerd staal, Mn staal en TM staal (0,15% legeringen).
- Uitstekende laskenmerken, de ideale all-round laselektrode voor veeleisende toepassingen in productie, buislassen en duurzame herstelwerkzaamheden.

Kenmerken:

- Lage waterstofopname (Moist resistant) voor verbeterde mechanische laseigenschappen.
- Lasstroom: AC/DC+
- Klasse: EN ISO 2560-A: E 46 4 B 42 H5 en AWS A5.1.E: 7018-1 H4R
- Metaal uitwisseling: 130%
- C: 0.05
- Si: 0.3
- Mn: 1.3
- Maximum reksterkte R(e): 470 N/mm²
- Treksterkte R(m): 570
- Uitbreiding A(5): 27%
- Impactsterkte KV: -40°C - >103.

Order nr.	Diameter mm	Leugte mm	Lasstroom A	Voor type	Gewicht kg	Prijs €
205960107 €	2.0	300	50-80	MMA	1,00	19,50
205960305 €	2.5	350	80-110	MMA	2,50	21,90
205960404 €	3.2	450	95-150	MMA	5,70	37,50
205960503 €	4.0	450	125-210	MMA	6,00	41,90



"RM70" lasdraad voor MIG lassen van niet-gelegeerde en gezandstraald staal

Kenmerken:

- Met koper omhuld tegen roesten
- Silicium/mangaan gelegeerde lasdraad.
- Geproduceerd met de modernste machines en met de grootste zorg voor kwaliteit om een optimaal lasproces te kunnen garanderen.
- Volgens de volgende normen EN 440 G3Si1 en AWS A5.18 ER 70 S-6.
- Maximum rekvermogen Re 420 N/mm².
- Maximum trekvermogen Rm 520 N/mm². Lasstroom:DC+.

Prijs per rol.

Order nr.	Diameter mm	Haspel diameter mm	Voor type	Gewicht kg	Prijs €
206030207 €	0,6	200	MIG-MAG	5,00	83,90
206030306 €	0,8	200	MIG-MAG	5,00	39,90
206030405 €	0,8	300	MIG-MAG	15,00	66,90
206030504 €	1	300	MIG-MAG	15,00	63,50
206030603 €	1,2	300	MIG-MAG	15,00	61,50



Lasdraad van pure aluminium.

Geslacht voor:

- MIG lassen van niet-gelegeerd aluminium van kwaliteit SS 4005 4007 4010.

Kenmerken:

- De las kan gemakkelijk worden behandeld en heeft goede corrosie- en geleidingseigenschappen.
- Volgens de volgende normen AWS A5.10- ER 1100.
- Maximum rekvermogen Rp 0.2% 30 N/mm².
- Maximum trekvermogen Rm 100N/mm².
- Bedrijfstemperatuur: 630 - 640° C.
- Lasstroom: DC+.

OPMERKING ! Voor het lassen van aluminium moet het oppervlak grondig worden gereinigd.

Prijs per rol.

Order nr.	Diameter mm	Haspel diameter mm	Voor type	Gewicht kg	Prijs €
206060105	0,8	300	MIG-MAG	7,00	129,00
206060204	1	300	MIG-MAG	7,00	119,00
206060303	1,2	300	MIG-MAG	7,00	108,00



"RMI316" Lasdraad voor MIG lassen van RVS/Inox

Kenmerken:

- Voor Inox met laag koolstofgehalte of inox met 19CR12Ni en 2.7Mo.
- Voor staal volgens norm SS 2348, 2375, 2333, 2343 en 2353.
- Voor koolstof Nb of Ti gestabiliseerd staal (bedrijfstemperatuur onder de 400° C)
- Het verhoogde silicium gehalte resulteert in excellente eigenschappen
- hoge stabiliteit van de vlamboog
- constante en vlotte materiaalstroom
- kort interval van de vlamboog.
- Lasstroom: DC+.
- Klasse: EN ISO 14343 G: 19 12 3 LSi en AWS A5.9 ER 316 LSi
- C: 0.015
- Si: 0.82
- Mn: 1.82
- Cr: 18.3
- Ni: 12.33
- Mo: 2.51
- Maximum reksterkte R(p) 0.2%: 400 N/mm²
- Treksterkte R(m): 600 N/mm²
- Uitbreiding A(5): 40%
- Impactsterkte KV: 20°C - 11J; -196°C - 50J
- Beschermgas: Ar+1-3%0(2) 16-20 l/min (M13)

Order nr.	206140105	206140196	206140204
Diameter	mm 0.8	0.8	0.8
Haspel diameter	mm 100	200	300
Gewicht	kg 1,00	5,00	15,00
Prijs	€ 34,90	90,50	210,00



MIG Lasdraad voor staal.

keine rol ø 100mm

De bobijnen worden gemonteerd met de adapter 830990703.

Order nr.	Diameter mm	Haspel diameter mm	Voor type	Gewicht kg	Prijs €
830802132	0,6	100	MIG-MAG	0,83	9,80
830802395	0,6	200	MIG-MAG	5,25	47,90
830802133	0,8	100	MIG-MAG	0,85	8,70
830802396	0,8	200	MIG-MAG	5,39	40,50



MIG Lasdraad voor aluminium.

Kleine rol ø 100mm

Adapter voor een kleine bobijn beschikbaar: 830990703.

Order nr.	830802062	830802064
Diameter	mm 0,8	1,0
Haspel diameter	mm 100	100
Voor type	MIG-MAG	MIG-MAG
Gewicht	kg 0,50	0,52
Prijs	€ 29,50	27,50



MIG lasdraad op rol voor roestvrij staal.

keine bobijn ø 100mm

Adapter voor een kleine bobijn : 830990703.

Order nr.	830802051	830802061
Diameter	mm 0,8	0,8
Haspel diameter	mm 100	100
Voor type	MIG-MAG	MIG-MAG
Gewicht	kg 0,59	1,10
Prijs	€ 28,50	52,50



Gevulde lasdraad voor FLUX lassen op halfautomaten

Geschikt voor lassen zonder gas van staal

Order nr.	Diameter	Haspel diameter	Voor type	Gewicht	Prijs
	mm	mm		kg	€
830802145 €	1,2	100	FLUX	0,89	24,50
830802146 €	1,2	200	FLUX	3,37	84,50
830802179 €	0,9	100	FLUX	0,89	20,50
830802181 €	0,8	200	FLUX	3,40	103,00
830802188 €	0,9	200	FLUX	3,26	74,90
830802208 €	0,8	100	FLUX	0,87	24,50



Flux lasdraad voor lassen van staal zonder gas op halfautomaat

Geschikt voor:

- Het lassen van dunne materialen met een dikte van 1.0 - 5 mm en gegalvaniseerde metalen zonder gebruik van beschermingsgas.
- Constructie- en onderhoudswerk, Industrie en hobby, automotive en doe het zelf.

Kenmerken:

- Mag in alle richtingen en posities gelast worden.
- Kan gelast worden met ampère vanaf 25 Amp, wat het risico op doorbranden van het metaal vermijdt.
- Lasstroom: DC-
- Klasse: AWS 5.20 E 71T-GS
- Treksterkte R(m): 520 N/mm²

Prijs per rol.

Order nr.	206190100 €	206190209 €
Diameter	mm 0,9	0,9
Haspel diameter	mm 100	200
Voor type	FLUX	FLUX
Gewicht	kg 0,90	4,50
Prijs	€ 16,90	272,00



Braseerdraad voor elektrisch hardsolderen met halfautomaten.

Type CUSi3 en CuAl8

kleine bobijn ø 100mm

Order nr.	Materie	Diameter	Haspel diameter	Voor type	Gewicht	Prijs
		mm	mm		kg	€
830802495 €	CuSi3	0,8	100	MIG-MAG	0,95	82,50
830802434 €	CuSi	0,8	200	MIG-MAG	3,00	249,00
830802496 €	CuAl8	0,8	100	MIG-MAG	0,95	82,50
830802439 €	CuAl	0,8	200	MIG-MAG	3,00	249,00



TIG Lasdraad voor lassen van staal

Luna RT70 Toevoegmateriaal.

Geschikt voor:

- Ongelegeerd en laaggelegeerd staal.
- Silicium-magnesium gelegeerde staaldraad, voor lassen met goede mechanische eigenschappen.

Kenmerken:

- Klasse: EN ISO 636: A-W 2 Si Material No 1.5125 en AWS A5.18: ER: 70-S-6
- C: 0.09
- Si: 0.87
- Mn: 1.47
- Maximum reksterkte R(p): 420 N/mm²
- Treksterkte R(m): 500 N/mm²
- Uitbreiding A(5): 22%
- Impactsterkte KV: -50°C - 47J
- Beschermingsgas: Argon 7-11 l/min (l1)

Prijs per pak.

Order nr.	Diameter	Lengte	Voor type	Gewicht	Prijs
	mm	mm		kg	€
206040107 €	1.6	1000	TIG	5,00	50,50
206040206 €	2.0	1000	TIG	5,00	50,50
206040305 €	2.4	1000	TIG	5,00	42,90
206040404 €	3.0	1000	TIG	5,00	41,50



Inox elektrode met laag koolstofgehalte.

Geschikt voor:

- TIG lassen van inox die 19CR 12Ni en 2.7Mo bevat.
- Kan gebruikt worden op staal volgens SS 2348, 2375 (RUS), 2343 en 2353.
- Kan ook gebruikt worden voor gewoon koolstof staal dat Nb of Ti gestabiliseerd is op voorwaarde dat de bedrijfstemperatuur onder de 400° C is.

Kenmerken:

- Lasstroom: DC-
- Klasse: EN ISO 14343: W 19 12 3 LSi en AWS A5.9 ER 316 LSi
- C: 0.015
- Si: 0.82
- Mn: 1.82
- Cr: 18.3
- Ni: 12.33
- Mo: 2.51
- Maximum reksterkte R(p)0.2%: 400 N/mm²
- Treksterkte R(m): 600 N/mm²
- Uitbreiding A(5): 40%
- Impactsterkte KV: 20°C - 120J; 196°C - 50J
- Beschermgas: Ar 99,99%, 6-12 l/min (l1)

Prijs per pak.

Order nr.	206150203 €	206150302 €	206150401 €
Diameter	mm 1,6	2	2,4
Lengte	mm 1000	1000	1000
Voor type	TIG	TIG	TIG
Gewicht	kg 5,00	5,00	5,00
Prijs	€ 63,90	59,90	62,90

ALMg5



Magnesium legering aluminium elektrode.

Geschikt voor:

- TIG-lassen van zeewater resistente aluminium legeringen die tot 5% Mg bevatten.

Kenmerken:

- RT ALMg5 is de meest gebruikte elektrode voor het lassen van aluminium.
- Lasroom: AC
- Klasse: EN 18273 S Al 5356 (ALMg5(A) en AWS A5.10-ER 5356
- Si: 0.06
- Mn: 0.13
- Al: bal.
- Mg: 5
- Fe: 0.12
- Maximum reksterkte R(p)0.2%: 120 N/mm²
- Treksterkte R(m): 255 N/mm²
- Uitbreiding A(5): 24%
- Smeltemperatuur: 560-650°C
- Beschermgas: Argon 5-10 l/min (I1) - Helium 8-6 l/min (I2) - Argon/Helium 5-10 l/min (I3)

OPMERKING ! Voor het lassen van aluminium moet het oppervlak grondig worden gereinigd.

Prijs per pak.

Order nr.	Diameter mm	Lengte mm	Voor type	Gewicht kg	Prijs €
206090052	1,6	1000	TIG	2,00	35,90
206090102	2,4	1000	TIG	2,00	29,90
206090201	3,2	1000	TIG	2,00	30,90
206090300	4	1000	TIG	2,00	27,50

ALMg5



DINSE stekker Male - 2 stk.

Order nr.	830802558	830802559
Diameter	mm 25	50
Gewicht	kg 0,11	0,31
Prijs	€ 10,90	15,50

ALMg5



Lastang voor elektrodelaassers.

Order nr.	830802538	830802539
Ampère	A 300	400
Gewicht	kg 0,30	0,49
Prijs	€ 10,90	15,50

ALMg5



Aardingsklemmen.

Order nr.	830802533	830802534	830802535
Ampère	A 250	400	600
Gewicht	kg 0,18	0,43	0,59
Prijs	€ 6,50	13,50	24,50

ALMg5



Bikkamer.

Order nr.	830802543
Voor type	MMA
Gewicht	kg 0,25
Prijs	€ 8,70

ALMg5



Anti-stick spray.

Kenmerken:

- Voorkomt lasspatten op werkstuk en toorts.
- Verbeterd de werkefficiëntie.

Order nr.	830722000
Voor type	MMA
Gewicht	kg 0,46
Prijs	€ 8,10

ALMg5



Kleine as voor kleine bobijnen

Kenmerken:

- geschikt voor bobijnen ø 100mm, 1kg
- ø 16/50 mm
- Maximum gewicht 5 kg.

Order nr.	830990703
Voor type	MIG-MAG
Gewicht	kg 0,02
Prijs	€ 5,60

Lasbescherming



Lasschort.

Order nr.	830802550 €	
Orig. nr.	802550	
Gewicht	kg	0,50
Prijs	€	31,50



Hittebestendige dekens.

Bescherming tegen spatten, sprays, spaanders, etc...

Kenmerken:

- Hitte- en scheurbestendig.

Order nr.	830802678 €	830802679 €
Orig. nr.	802678	802679
Kleur	rood	wit
Maximum temperatuur °C	550	1100
Gewicht	kg	3,00
Afmetingen (l x b x h)	mm	1480 x 1910 x 0
Prijs	€	40,50
		110,00



PVC lasscherm.

Bescherming tegen UV, fel licht, en lasspatten.

Kenmerken:

- Metalen onderstel met wielen.
- Conform EN 1598.

Order nr.	830803508 €	830803509 €
Orig. nr.	803508	803509
Kleur	oranje	groen
Afmetingen scherm	mm	1740x1740
Afmetingen frame	mm	670x1790x1960
Gewicht	kg	7,80
Prijs	€	123,00
		123,00



MADE IN EUROPE

Laslaars in waterafstotend rundsnerf leder.

Kenmerken:

- veiligheidsklasse : S3
- kleur : bruin
- schacht : rundsnerf leder
- buitenzool : PU/rubber
- binnenzool : antistatisch , anatomisch
- tussenzool : staal
- neus : staal
- overneus : rubber
- met lasbescherming

Order nr.	Orig. nr.	Maat	Prijs €
860002239	SHATL1139	39	102,00
860002240	SHATL1140	40	102,00
860002241	SHATL1141	41	102,00
860002242	SHATL1142	42	102,00
860002243	SHATL1143	43	102,00
860002244	SHATL1144	44	102,00
860002245	SHATL1145	45	102,00
860002246	SHATL1146	46	102,00
860002247	SHATL1147	47	102,00

Autogene lasapparaten

MACH



Gecombineerde lasbrander en snijtoestel.

Kenmerken:

- Schacht diameter 17mm.
- Om te lassen van 0,5 - 9 mm en te snijden van 3 - 100 mm.

Geleverd in plaatstalen koffer.

Order nr.	711700117
Orig. nr.	KEK17
Gewicht	kg 1,00
Prijs	€ 359,00

MACH

Koffer acetyleen lassen/snijden.

Bevat:

- 1 gasregelaar Jetcontrol O2
- 1 gasregelaar Jetcontrol AD
- 2 x 10 m slang Ø 10 x 17 O2/AD
- 2 slangen 50 cm Ø 10 x 17 O2/AD
- 2 slangen 50 cm Ø 6,3 x 12 O2/AD
- 1 snijder Darcut G1 met 1 buis Ø 16/10
- 1 lasser Jetsoud OT acetyleen met sterleutel 6 bekken
- 2 anti-retour Super Securidave O2/AD (ISO - Ø 6,3 x 12 / 10 x 17)
- 2 vrouwelijke Stoptac O2/AD Ø 6,3 x 12
- 1 slijper met 12 vijlen
- 1 storm gasaansteker
- 1 bril met opklapbare glazen
- Moeren, fittingen, klemmen
- 1 blauwe koffer



Order nr.	910000210
Orig. nr.	AGSOSET
Gewicht	kg 13,00
Afmetingen (l x b x h)	mm 580 x 400 x 320
Prijs	€ 675,00

MACH



Spoel soldeertin 60% tin. 100 g.

Order nr.	910000211
Orig. nr.	AGSO100
Gewicht	kg 0,12
Afmetingen (l x b x h)	mm 53 x 53 x 55
Prijs	€ 7,60

Soldeergereedschap

TOOLS



Heteluchtpistool 2000W met 2 temperatuurstanden 350/550 °C, 8-delig.

Voor o.a. het verwijderen van verf, aanbrengen van krimpfolie,...

Geleverd met reflector, sponning, reduceer- en plat mondstuk. In kunststof opbergkoffer.

Order nr.	722410001
Orig. nr.	SLG2000
Maximum temperatuur	°C 350-550
Vermogen	W 2000
Gewicht	kg 0,75
Prijs	€ 41,50

TOOLS



Soldeerbout voor het lichtere soldeerwerk. 230V.

Geleverd in blister met stand, rechte soldeerpunt en gebogen platte soldeertip.

Order nr.	722310033	722310034	722310035
Orig. nr.	SL025	SL060	SL100
Maximum temperatuur	°C 380	470	550
Vermogen	W 25	60	100
Gewicht	kg 0,20	0,20	0,25
Prijs	€ 3,70	4,40	6,30

TOOLS



6-delige set met soldeeraccessoires, in kunststof opbergkoffer.

Bevat 10 gr tindraad, tinopneempomp, spons, lasvloeistof, pincet, draadhouder/naaldpunt.

Order nr.	722310036
Orig. nr.	SLA6
Gewicht	kg 1,00
Prijs	€ 22,50

TOOLS



Laspistool 200W met temperatuurregeling (3 standen), 6-delig.

Geleverd in kunststof opbergkoffer, geleverd met 1 moersleutel, 2 soldeertips, 10g lasvet, 10g lasvloeistof.

Order nr.	722310037
Orig. nr.	SLP200
Temperatuur	°C 70-500
Vermogen	W 200
Gewicht	kg 1,30
Prijs	€ 44,50

Plasma branders



Draagbare plasma inverter. Snijsystemen op gecomprimeerde lucht, met koelventilator en contact striking, gestuurd door microprocessor.

Geschikt voor:

- Snel snijden en zonder vervormingen van alle geleidende materialen zoals staal, inox, gegalvaniseerd metaal, aluminium, koper, messing.

Kenmerken:

- Beperkt gewicht en grootte.
- Alarmlicht bij ondervoltage van de toorts, beveiligingen.
- Mogelijkheid tot snijden op traliewerk met automatisch herstarten van de boog.
- Thermische beveiliging en beveiliging tegen overspanning, onderspanning, overbelasting, toorts kortsluiting.
- Snijdikte en snelheid hangen samen.
- De maximale snijdikte wordt bereikt bij heel traag snijden.

Geleverd met toorts van 4m en drukregelaar.

Order nr.	830815493 €		
Orig. nr.	TECHNOLOGYPLASMA41		
Spanning	V	230	
Maximum snijdikte (*)	mm	12	
Maximum inschakelduur	A	30% @ 35	
Regelbereik	A	7-40	
Luchtverbruik	l/min	100	
Werkdruk	bar	4-5	
Maximum opgenomen vermogen	kW	4	
Maximum opgenomen stroom	A	28	
Nullastspanning	V	406	
Krachtfactor	cos fi	0,7	
Rendement	eta	0,85	
Isolatieklasse		H	
Beschermingsklasse	IP	23	
Toorts		✓	
Gewicht	kg	7,60	
Afmetingen (l x b x h)	mm	450 x 150 x 270	
Prijs	€	869,00	



Draagbare plasmasnijder op gecomprimeerde lucht, met koelventilator en contact striking.

Voorzien van een ingebouwde compressor.

Geschikt voor:

- Snel snijden en zonder vervorming van alle geleidende materialen zoals staal, inox, gegalvaniseerd metaal, aluminium, koper, messing.

Kenmerken:

- Beperkt gewicht en grootte.
- Alarmlicht bij ondervoltage van de toorts, beveiligingen.
- Aanduiding van de luchtdruk.
- Thermische beveiliging en beveiliging tegen overspanning, onderspanning en overbelasting.

Geleverd met toorts van 4m.

Order nr.	830815088 €		
Orig. nr.	TECHNOLOGYPLASMA54K		
Spanning	V	230	
Maximum snijdikte (*)	mm	10	
Maximum inschakelduur	A	35@30%	
Regelbereik	A	7-40	
Maximum opgenomen vermogen	kW	4,5	
Maximum opgenomen stroom	A	27,5	
Nullastspanning	V	380	
Krachtfactor	cos fi	0,7	
Rendement	eta	0,7	
Isolatieklasse		H	
Beschermingsklasse	IP	23	
Toorts		✓	
Gewicht	kg	16,80	
Afmetingen (l x b x h)	mm	550 x 170 x 340	
Prijs	€	1.145,00	

Accessoires plasma



Plasmatoorts gebogen model

Order nr.	Voor type	Lengte m	Prijs €
830742239	Tecnica Plasma 34 Kompressor	4	298,00
830742237	Tecnica Plasma 31 Kompressor	4	298,00
830742381	Technology Plasma 54 Kompressor	4	298,00
830742065	Tecnica Plasma 41, Technology Plasma 41	6	312,00
830742040	Superior Plasma 60 HF	6	314,00
830722332	Superior Plasma 90 HF	6	424,00
830722333	Superior Plasma 90 HF	12	619,00



Plasma toorts recht model

Order nr.	830722334	
Voor type	Superior Plasma 90 HF	
Lengte	m	12
Prijs	€	799,00



Afstandhouder. Enkel leverbaar voor 60/90HF modellen.

Order nr.	830802128	830802127
Voor type	Superior Plasma 60 HF	Superior Plasma 90 HF
VE	5	1
Prijs/VE	€ 16,50	16,50



Electroden voor plasmatoorts lang model

Order nr.	830802428	
Omschrijving	lange elektrode	
Voor type	31, 41	
VE	5	
Prijs/VE	€	39,50



Electroden voor plasmatoorts. VE = verpakkingseenheid.

Order nr.	Omschrijving	Voor type	VE	Prijs/VE €
830802420	elektrode	31, 41, 34-54K	5	24,50
830802122	elektrode	Super Plasma 90HF	1	26,50
830802076	elektrode	Super Plasma 60HF	1	24,50



Electroden voor plasmatoorts. VE = verpakkingseenheid.

Order nr.	Omschrijving	Voor type	Prijs €
830802078	lange elektrode	Super Plasma 60HF	28,50
830802077	bek	Super Plasma 60HF	18,50
830802079	lange bek	Super Plasma 60HF	24,50



Electroden voor plasmatoorts. VE = verpakkingseenheid.

Order nr.	Omschrijving	Voor type	Prijs €
830802082	lange elektrode	Super Plasma 90HF	54,50
830802119	bek	Super Plasma 90HF	20,50
830802083	lange bek	Super Plasma 90HF	55,90



Veiligheidskapjes. VE = verpakkingseenheid.

Order nr.	Voor type	VE	Prijs/VE €
830802425	Tecnica Plasma 31,41	1	47,90
830802081	Superior Plasma 60 HF	2	35,90
830802126	Superior Plasma 90 HF	2	84,50
830802096	Tecnica Plasma 34 K	2	58,90
830802485	Tecnica Plasma 54 Kompressor	2	34,90



Diffusors voor plasmatoorts. VE = verpakkingseenheid.

Order nr.	830802422	830802080	830802123
Voor type	Tecnica Plasma 31,34K,41, Technology plasma 41, Technology 54 Kompressor	Technology Plasma 60 HF	Technology Plasma 90 HF
VE	5	2	5
Prijs/VE	€ 85,50	39,50	84,50

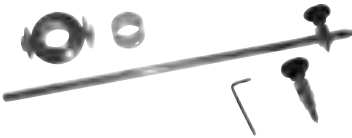

Cirkelsnijder voor plasma-snijders Telwin 31, 41, 54K en 34K.

Order nr.	830802214	
Maximum diameter	mm	680
Prijs	€	60,90



Accessoires Plasma - Bek

Order nr.	830802423	830802092	830802429
Omschrijving	bek	bek	lange bek
Voor type	31, 41, 54K	34K	31, 41
VE	5	5	5
Prijs/VE	€ 27,50	30,50	32,50



Elektrode voor plasmasnijder CUT45HF.

Order nr.	829300222	
Orig. nr.	CUT45HF-EL	
Gewicht	kg	1,00
Afmelingen (l x b x h)	mm	10 x 10 x 10
Prijs	€	5,75



Mondstuk voor plasmasnijder CUT45HF.

Order nr.	829300226	829300224
Orig. nr.	CUT45HF-NOZ0.8	CUT45HF-NOZ1.0
Maat	mm	0,8
Gewicht	kg	1,00
Afmelingen (l x b x h)	mm	10 x 10 x 10
Prijs	€	5,75



Beschermkap voor plasmasnijder CUT45HF.

Order nr.	829300227	
Orig. nr.	CUT45HF-COV	
Gewicht	kg	1,00
Afmelingen (l x b x h)	mm	10 x 10 x 10
Prijs	€	5,95

Puntlasapparaten



Puntlasapparaat, met elektronische controle van de puntlastijd.

Kenmerken:

- Synchrone elektronische timer, met puntlastijd instelbaar van 0,1 sec. tot 1,2 sec.
- Automatische regeling van de lastijd en lasroom.
- Druk op de armen instelbaar van 40 tot 120 kg.
- Handvat thermisch isolerend.

Standaard geleverde armen: lengte 120 mm.

Order nr.	830823015 €	
Orig. nr.	MODULAR 20/TI	
Spanning	V	230
Inschakelduur I _{max}	A @ %	1,5
Kranchfactor	cos fi	0,9
Beschermingsklasse	IP	20
Maximum puntlasroom	A	3800
Maximum puntlasdikte	mm+mm	1,0+1,0
Secundaire nullastspanning	V	2
Geschikt voor staal		✓
Geschikt voor RVS		✓
Geschikt voor alu		✓
Lastype		puntlassen
Gewicht	kg	10,00
Afmetingen (l x b x h)	mm	440 x 100 x 185
Prijs	€	609,00



DIGITAL MODULAR 230

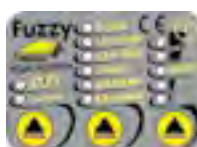

Dragbare puntlas apparaten, gestuurd door microprocessor.

Controle systeem "FUZZY LOGIC" voor eenvoudiger gebruik en een superieure kwaliteit. Ontworpen voor puntlassen van plaatmateriaal met een dikte van maximum 2 + 2 mm.

Kenmerken:

- Automatische regeling van de lastijd en lasroom.
- Keuze tussen continu/puls werking (voor plaatijzer met high-stress rekpunten en gegalvaniseerd staal).
- Druk op de armen instelbaar van 40 tot 120 kg.
- Handvat thermisch isolerend.

Standaard geleverde armen: lengte 120 mm.

Order nr.	830823016 €		830823017 €
	DIGITAL MODULAR		DIGITAL MODULAR 400
Orig. nr.	230		
Spanning	V	230	400 1ph
Kranchfactor	cos fi	0,9	0,9
Beschermingsklasse	IP	20	20
Maximum puntlasroom	A	6300	6300
Maximum puntlasdikte	mm+mm	2,0+2,0	2,0+2,0
Secundaire nullastspanning	V	2,5	2,5
Geschikt voor staal		✓	✓
Geschikt voor RVS		✓	✓
Geschikt voor alu		✓	✓
Maximum inschakelduur (EN60974-1, bij 40°)	%	1,5	1,5
Maximum opgenomen vermogen	kW	13	13
Zekering op het net	A	25	16
Isolatieklasse		B	B
Gewicht	kg	10,50	10,30
Afmetingen (l x b x h)	mm	440 x 100 x 185	440 x 100 x 185
Prijs	€	824,00	835,00



Puntlasapparaat, gestuurd door microprocessor voor toepassing in de carrosserie.

Voordelen:

- Het multifunctionele controlepaneel laat de automatische regeling toe van puntlasparameters in functie van het gekozen werktuig en de dikte van het plaatijzer.

Geschikt voor:

- Lassen van nagels, schroeven, sluitringen, rivetten en speciale sluitringen, opwarming van plaatijzer, stuiking en verstellen.
- Perfect om een eenvoudige en complexe builen te repareren.

Geleverd met "STUDDER" kit BASIC.

Order nr.	830823252 €	830823000 €
Orig. nr.	DIGCARSPOT-TER5500P2	DIGCARSPOT-TER5500P4
Spanning	V 230	400 1ph
Nullastspanning	V 5,4	5,4
Krachtfactor	cos fi 0,7	0,7
Beschermingsklasse	IP 22	22
Maximum puntlasstroom	A 3000	3000
Maximum puntlasdikte	mm+mm 1,5+1,5	1,5+1,5
Geschikt voor staal	✓	✓
Geschikt voor RVS	✓	✓
Maximum inschakelduur (EN60974-1, bij 40°)	% 3,0	3,0
Maximum opgenomen vermogen	kW 11	11
Zekering op het net	A 16	16
Isolatieklasse	H	H
Gewicht	kg 30,00	29,60
Afmetingen (l x b x h)	mm 390 x 260 x 225	390 x 260 x 225
Prijs	€ 1.189,00	1.455,00



NEW

Inductieverwarmer voor gericht en snel losmaken van vastzittende, verroeste, of bevroren bouten, moeren, rollagers, assen, ...

Geleverd met de buigzame spiraal "heat twister", voor perfecte aansluiting rondom het vastzittende deel.

Voordelen:

- Precies en snel werken.
- **Geen gasbrander meer nodig, veiliger werken**
- **Zeer gericht werken: warmt de oppervlakten niet onnodig op**
- Het verhitten gaat in enkele seconden
- Manuele of automatische warmte regeling
- Brengt geen schade toe aan gevefde oppervlakken, glas, rubber of plastic
- Geleverd met "heat twister". Aparte spiralen leverbaar M8, M12, M16
- Ook voor moeilijk bereikbare plaatsen op voertuigen, machines, ...

Optie:

- Vlakke inductietool. Grote inductietool voor vlakke oppervlakken
- Geschikt voor verf, glas, stickers, plastics, ... art. 830801400
- Haakse inductietool. Geschikt voor bouten, assen, hoeken, moeilijk bereikbare plaatsen art. 830801401
- Inductie toolpad. Flexibel textiel pad, dat elke grillige vorm volgt.
- Geschikt voor etiketten, logo's, moulures, kunststoffen, typeplaatjes, ... art. 830801402

Order nr.	830835012 €
Orig. nr.	SI5000TWIST
Spanning	V 200-240
Vermogen	kW 2,4
Frequentie	Hz 35-100
Beschermingsklasse	IP 21
Gewicht	kg 7,10
Afmetingen (l x b x h)	mm 390 x 260 x 230
Prijs	€ 999,00

Accessoires puntlassen



Lasrivetten voor spotters. VE = verpakkingseenheid.

Order nr.	Omschrijving	VE	Prijs/VE €
830802297	rivet 3 x 3,2 mm	100	10,90
830802298	rivet 3 x 4,5 mm	100	10,90
830802299	rivet 5 x 10 mm	100	14,50
830802302	rivet 5 x 12 mm	100	14,50
830802303	rivet 5 x 18 mm	100	14,50
830802304	rivet 5 x 25 mm	100	17,50
830802295	100 sluitringen fe-cu d. 8x16	100	10,90
830802296	100 driehoek sluitringen fe-cu	100	69,90
830802300	rivet 4 x 15 mm	100	14,50
830802301	rivet 5 x 18 mm	100	14,50
830802339	spiraaldraad	50	60,90
830802293	nagels 2 x 50 mm	100	8,70
830143276	nagel-en rivettenset	1	275,00



Accessoire. Waterkoeling GRA901 voor Digital spotter 9000, PTE en PCP.

Order nr.	€	830802043
Prijs	€	779,00



Complete studder box voor Digital Car Spotter 5500 plus.

Order nr.	€	830143593
Prijs	€	89,50

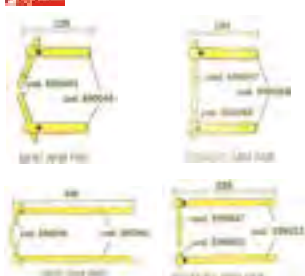

Paar armen met elektrodes voor MODULAR 20/ TI-230-400 .

Order nr.	Lengte mm	Prijs €
830803150	120	102,00
830803151	120	82,50
830803152	250	161,00
830803153	350	182,00
830803154	350	165,00
830803155	120	129,00
830803156	500	242,00
830803158	120	110,00
830803159	140	179,00



Heat twister tool voor smart inductor 5000

Order nr.	€	830801412
Prijs	€	388,00



Wonder pen II voor smart inductor 5000.

Order nr.	€	830801420
Orig. nr.		801420
Gewicht	kg	0,86
Afmetingen (l x b x h)	mm	290 x 230 x 100
Prijs	€	279,00



Tool voor bouten Smart inductor 5000

Order nr.	€	830801401
Prijs	€	388,00



Vlakke inductietool voor Smart Inductor 5000.

Voor vlakke oppervlakken
Geschikt voor verf, glas, stickers, plastics, ...

Order nr.	€	830801400
Orig. nr.		801400
Gewicht	kg	1,70
Prijs	€	432,00



Tool pad voor Smart inductor 5000

Order nr.	€	830801402
Prijs	€	290,00



Tool voor glas voor Smart inductor 5000

Order nr.	€	830801403
Prijs	€	492,00

LASTOESTELLEN

De MW MACH lastoestellen maken gebruik van zeer goed presterende stroominverters. Hierdoor maken we komaf met alle nadelen van transformator lastoestellen.

Perfekte lasresultaten

Hoogfrequente inverters zorgen voor een constante en stabiele vlamboog, met een perfecte inbranding en lasnaadruiterlijk als resultaat. Door de complete en gebruiksvriendelijke totaalcontrole over de digitale lasparameters, zijn deze machines inzetbaar in elke omgeving. Hot start, Anti stick and arc force maken het elektrodelassen heel eenvoudig voor elke lasser.

Een hoge inschakelduur

Dit betekent sneller werken, en dus minder tijdverlies. De performante elektronica garandeert een lage warmteontwikkeling, waardoor de toestellen kunnen blijven werken, ook op hoge lasstroom.

Combinatiemachines, licht en compact

Twijfelt u bij de keuze voor een lastoestel die MMA, MIG-MAG, MIG-MAG-FLUX of TIG kan lassen? Zoek niet verder, want elk MW MACH lasapparaat kan 2 of meer lasfuncties tegelijk aan. Dit verhoogt uw werkcomfort en is tijdsbesparend. Minder lastoestellen betekent ook meer ruimte in uw werkplaats. Ondanks de verschillende functies van deze lastoestellen, blijven ze zeer licht en compact. Dankzij de bijhorende koffer komt u en werkt u vlot tot in moeilijk bereikbare plaatsen.

Stevig design

Onze MW MACH lasapparaten zijn draagbare machines met weloverwogen, gestroomlijnd design zodat u ongehinderd kunt werken zonder tijdverlies. De lastoestellen zijn bestand tegen spatwater, stof en metaalstof dankzij een printplaatcoating. De hoge schok- en crashbestendigheid en de verzonken bedieningsknoppen maken deze lasapparaten perfect inzetbaar in de moeilijkste omstandigheden. Netstroompieken of onstabiele stroom van verlengkabels vormen geen probleem. De lastoestellen werken ook energiebesparend. De processor gestuurde micro-elektronica wekt op energie-efficiënte wijze de lasstroom op.





MMA lasapparaten



TEC160



TEC200

Lasinverter voor elektrodelasan.

Voordelen:

- Compact en zeer licht.
- Hoge inschakelduur van 30%
- Permanente elektronische controle van de vlamboog.
- Bruikbare elektroden: rutiel, basis, roestvrij staal, gietijzer, ...

Gemakkelijk lassen:

- **Hot Start** voor een optimale opstart zonder spatten.
- **Arc Force** voor het behouden van de vlamboog tijdens contact met het smeltbad.
- **Anti stick** voorkomt dat elektrodes kleven bij een te lage lasstroom.
- Bescherming tegen overbelasting, overspanning en onderspanning

Geleverd met plastic koffer, massatang en electrodehouder.

Order nr.		829000160 €	829010200 €
Orig. nr.		TEC160	TEC200
Spanning	V	230	230
Inschakelduur I _{max}	A @ %	160 @ 30%	200 @ 30%
Regelbereik	A	28-160	30-200
Capaciteit elektroden	mm	3,2	4,0
Opgenomen vermogen 60%/maximum	kW	5,27	8,5
Nullastspanning	V	67	75
Kranchfactor	cos φ	0,85	0,80
Beschermingsklasse	IP	21S	21S
Geschikt voor staal		✓	✓
Geschikt voor RVS		✓	✓
Geschikt voor alu		✓	✓
lastype		MMA	
Gewicht	kg	7,00	8,10
Afmetingen (l x b x h)	mm	385 x 170 x 390	405 x 260 x 275
Prijs	€	135,00	169,00

MAGH

MMA

INVERTARC160



INVERTARC160



Lasinverter voor MMA elektrodelassen.

Voordelen:

- Eenvoudig model voor algemeen gebruik.
- Moderne, betrouwbare 40kHz IGBT invertermodule met eenvoudige bediening.
- Hoge ergonomie tijdens het werken: draagriem, lichtgewicht, compact, verzonken bedieningsknoppen, en geluidsarme werking.
- Automatische compensatie van spanningsverschillen op het net tot +/- 15%.
- Met beperkte elektromagnetische invloed op toestellen in de omgeving (pc's, elektronica, ...)
- Thermische veiligheid tegen overbelasting.
- CE en EMC conform

Gemakkelijk lassen:

- Stabiele vlamboog dankzij Hot Start voor een optimale opstart zonder spatten, en Arc Force voor het behouden van de vlamboog tijdens contact met het smeltbad.
- Anti stick voor komt plakken van de elektrode.

Geschikt voor:

- Alle soorten laselektroden tot \varnothing 3,2mm (rutiel, basisch, ...).
- Geschikt voor gebruik op werven.

Scratch TIG lassen optioneel.

 Geleverd met elektrodetang en massaklem (3+3m 16mm² kabel), borstel, manuele lashelm en ALU- draagkoffer.

Order nr.		829300190 €
Orig. nr.		INVERTARC160
Spanning	V	230 ±15%
Inschakelduur I _{max}	A @ %	160 @15%
Regelbereik	A	10-160
Capaciteit elektroden	mm	4,0
Nullastspanning	V	63
Kranchfactor	cos fi	0,7
Beschermingsklasse	IP	21
Lastype		MMA
Gewicht	kg	4,70
Afmetingen (l x b x h)	mm	313 x 130 x 250
Prijs	€	229,00

MAGH

MMA
MMA

+ GRATIS
LASHHELM & ELEKTRODEN

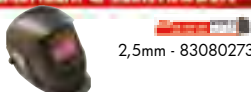

2,5mm - 830802739

PROTECT 413



Lasinverter voor MMA elektrodelassen.

Voordelen:

- Hoge inschakelduur 30% op 200A
- Moderne, betrouwbare 40kHz IGBT invertermodule met eenvoudige 1-knopsbediening.
- Hoge ergonomie tijdens het werken: lichtgewicht, compact, met anti-slip handgreep, schouderband, verzonken bedieningsknoppen, en geluidsarme werking.
- Automatische compensatie van spanningsverschillen op het net tot +/- 15%.
- Met beperkte elektromagnetische invloed op toestellen in de omgeving (pc's, elektronica, ...)
- Thermische veiligheid tegen overbelasting.
- CE en EMC conform.

Gemakkelijk lassen:

- Stabiele vlamboog dankzij **Hot Start** voor een optimale opstart zonder spatten, en **Arc Force** voor het behouden van de vlamboog tijdens contact met het smeltbad.

Geschikt voor:

- Industrieel gebruik.
- Geschikt voor alle soorten laselektroden tot \varnothing 5mm (rutiel, basisch, ...)
- IP21 geschikt voor gebruik op werven.

Scratch TIG lassen in optie.

Geleverd met elektrodetang en massaklem (3+3m 16mm² kabel), borstel, manuele lashelm en slagvaste kunststof draagkoffer

Order nr.	829300192 €	
Orig. nr.	V	ARC200
Spanning		230
Inschakelduur I _{max}	A @ %	200 @35%
Regelbereik	A	10-200
Capaciteit elektroden	mm	4,0
Nullastspanning	V	75
Krachtfactor	cos fi	0,7
Beschermingsklasse	IP	21
Lastype		MMA
Gewicht	kg	5,20
Afmetingen (l x b x h)	mm	351 x 130 x 250
Prijs	€	239,00

MIG-MAG-FLUX lasapparaten



Draagbare halfautomaten voor MIG/MAG lassen (met gas) en FLUX lassen (zonder gas). Ook geschikt voor elektrode lassen (MMA) met optionele set.



MIG/MAG/FLUX lassen

- MIG lassen in Staal, Inox, RVS, aluminium, ...
- draaddiktes tot 1,0 mm en polariteit regelbaar
- Stabiele vlamboog met weinig lasspatten, en zuivere lasnaad als resultaat
- Regelbare parameters: lasstroom (A), lasspanning (V), draaddoorvoersnelheid (m/min.), down slope en burn back

MMALassen:

- of \varnothing 5 mm met optionele set
- Stabiele vlamboog: Hot Start voor een optimale opstart zonder spatten, en Arc Force voor het behouden van de vlamboog tijdens contact met het smeltbad

Kenmerken:

- Hoge ergonomie tijdens het werken: lichtgewicht, compact, verzonken bedieningsknoppen, geluidsarme werking en met anti-slip handgreep (MIG160E met schouderband)
- Met **VRD functie**: beveiliging van de gebruiker tegen stroomschokken
- Automatische compensatie van spanningsverschillen op het net tot \pm 15%
- Corrosie- en impactbestendige behuizing uit plaatstaal/kunststof
- Thermische veiligheid tegen overbelasting
- CE en EMC conform

Geleverd met

- lastoorts 3 meter met EUROconnector,
- 3 m massakabel 16mm²
- gasontspanner met dubbele manometer.



Order nr.		829300196 €	829300210 €
Orig. nr.		MIG160E	MIG200E
Spanning	V	230 \pm 15%	230 \pm 15%
Inschakelduur Imax	A @ %	160 @20%	200@20%
Regelbereik	A	10-160	10-200
Capaciteit elektroden	mm	1,6-4,0	1,6-5,0
Opgenomen vermogen 60%/maximum	kW	7,1	9,4
Nullastspanning	V	53	53
Krachtfactor	cos fi	0,7	0,7
Beschermingsklasse	IP	21S	21S
Bobijn maximum	kg/mm	5/200	5/200
Capaciteit staal lasdraad	mm	0,6-0,9	0,6-1,0
Capaciteit inox lasdraad	mm	0,6-0,9	0,6-1,0
Capaciteit alu lasdraad	mm	0,6-0,9	0,6-1,0
Isolatieklasse		F	F
Lastype		MIG-MAG-FLUX	MIG-MAG-FLUX
Gewicht	kg	12,50	12,80
Afmetingen (l x b x h)	mm	485 x 185 x 370	485 x 185 x 370
Prijs	€	569,00	749,00



MIG160E

- 5kg/200mm bobijnen
- BURN BACK



MIG160E



MIG160E



MIG160E



MIG160E

MACHINES



COMPLETE MIG LASOPLOSSING VOOR UW WERKPLAATS



Lasset bestaande uit het lastoestel MIG200E, de lashelm PROTECT413, de laswagen LKA700 en een bobijn lasdraad RM70.

Order nr.	829300252
Orig. nr.	PACKMIG200E
Prijs	€ 829,00



TIG lasapparaten



Draagbare TIG lasinverter DC 180A.

Hoge inschakelduur 35 %, voor intensief lassen van staal, inox, RVS en hun legeringen.

TIG lassen:

- HF opstart van de vlamboog.
- Regelbare parameters: lasstroom (A), Down slope, Post flow, 2-takt/4-takt, en keuzeknop HF/Scratch TIG.

MMA elektrodelassen:

- Elektrodelassen met optionele laskit 830801102.
- Last alle soorten laselektroden tot \varnothing 5mm (rutiel, basisch, ...)
- Stabiele vlamboog dankzij Hot Start voor een optimale opstart zonder spatten, en Arc Force voor het behouden van de vlamboog tijdens contact met het smeltbad

Kenmerken:

- Moderne, betrouwbare IGBT invertermodule met complete controle over de parameters
- Hoge ergonomie tijdens het werken: lichtgewicht, compact, verzonken bedieningsknoppen, geluidsarme werking en met anti-slip handgreep.
- Automatische compensatie van spanningsverschillen op het net tot \pm 15%
- Corrosie- en impactbestendige behuizing uit plaatstaal/kunststof.
- Met beperkte elektromagnetische invloed op toestellen in de omgeving (pc's, elektronica, ...)
- Thermische veiligheid tegen overbelasting.
- CE en EMC conform

Geleverd met:

- TIG toorts 3m,
- 3m massakabel 16mm²
- gasontspanner met dubbele manometer.
- snelkoppeling voor losmaken van gas slang.

Order nr.		829300194 €
Orig. nr.		TIG180
Spanning	V	230
Regelbereik	A	10 ~ 180
Nullastspanning	V	65
Krachtfactor	cos fi	0,7
Isolatieklasse		F
Beschermingsklasse	IP	215
Inschakelduur I _{max}	A @ %	180 @35%
Lastype		TIG
Gewicht	kg	6,00
Afmetingen (l x b x h)	mm	365 x 135 x 277
Prijs	€	559,00





NEW

HF

MMA

TIG inverter DC met digitaal display en PULSE functie

Hoge inschakelduur 35 %, voor intensief lassen van staal, inox, RVS en hun legeringen.

Kenmerken:

- **TIG en PULSE TIG** lassen in gelijkstroom (DC) tot 200 A
- MMA elektrodelassen tot 180 A
- Hoge inschakelduur 35 %, voor intensief lassen van staal, inox, RVS, ...
- IGBT invertermodule met eenvoudige en snelle bediening, gelakte printplaat beschermd tegen slijpstof
- Hoge ergonomie tijdens het werken: lichtgewicht, compact, verzonken bedieningsknoppen, geluidsarme werking en met anti-slip handgreep
- Automatische compensatie van spanningsverschillen op het net tot +/- 15%
- Corrosie- en impactbestendige behuizing uit plaatstaal/kunststof
- Met beperkte elektromagnetische invloed op toestellen in de omgeving (pc's, elektronica, ...)
- Thermische veiligheid tegen overbelasting
- CE en EMC conform

TIG lassen:

- HF opstart van de vlamboog.
- Stabiele vlamboog met een zuivere lasnaad als resultaat
- PULSE functie voor een gecontroleerde warmte-inbreng
- Digitaal display met lascurve voor snel aanpassen van de parameters: lasstroom (A), Piekstroom, Up - en down slope, Pre- en Post flow, PULSE frequentie
- Memory van parameters
- 2-takt/4-takt,
- HF/Scratch TIG
- Puntlasfunctie voor het uniform herhaald punten

MMA elektrodelassen:

- Met optionele elektrodehouder
- Last alle soorten laselektroden tot ø 4mm (rutil, basisch, ...)
- Uiterst stabiele vlamboog:
 - Hot Start voor een optimale opstart zonder spatten
 - Arc Force voor het behouden van de vlamboog tijdens contact met het smeltbad

Geleverd met:

- TIG toorts 4 m
- massakabel 16 mm² 3 m
- gasontspanner met dubbele manometer.
- Snelkoppeling voor losmaken van gaslang.

Order nr.		829300202 €
Orig. nr.		TIG200P
Spanning	V	230
Regelbereik	A	10 ~ 200
Nullastspanning	V	65
Kranchfactor	cos fi	0,7
Isolatieklasse		F
Beschermingsklasse	IP	21S
Inschakelduur I _{max}	A @ %	200 @ 35%
Lastype		TIG
Gewicht	kg	8,00
Afmetingen (l x b x h)	mm	365 x 135 x 277
Prijs	€	589,00



• Lasstroom



• DX50
connectie

• Ontspanner met
2 manometers



• 4m TIG toorts

• Snelkoppeling GAS

MACHINES



TIG inverter voor AC/DC lassen.
200A in TIG, PULSE TIG, en MMA (elektrode)

Voordelen:

- Zeer hoge inschakelduur: 40 % bij 200A
- Voor industrieel lassen en productiewerk
- Digitale regeling op de machine
- Toorts 4 meter met regeling van stroom
- Ontwikkeld voor de zwaarste omstandigheden

TIG lassen:

- DC TIG: Staal, inox, RVS, koper, messing, titanium
- **AC TIG: Aluminium, brons, magnesium**
- Zuivere lasnaad door stabiele, gecontroleerde vlamboog
- **PULSE**lassen: gecontroleerde warmte-inbreng
- AC frequentie tto 250Herz voor een diepe penetratie van de vlamboog
- Helder digitaal display met regeling van: AC/DC, lasstroom, piekstroom, down slope, pre- en post-flow, pulse frequentie, pulse balans, pulse duty, AC clean width
- Memory functie voor 5 sets van parameters
- 2-takt/4-takt
- HF/Scratch TIG ontsteking

MMA elektrodelassen:

- Elektrodlassen AC en DC met optionele elektrodehouder
- tot ø 6 mm (rutil, basisch, ...)
- Hot Start voor een optimale opstart zonder spatten
- Regelbare Arc Force

Kenmerken

- Memory save bij stroompanne
- Spanningsverschillen op het net of in verlengkabel +/- 15%
- Corrosie- en impactbestendige behuizing
- CE en EMC conform
- IP21S geschikt voor gebruik op werven
- Beschermd tegen overbelasting en over- of onderspanning op het net

Geleverd met:

- TIG toorts 4 m
- massakabel 16 mm² 3 m en klem
- Gasontspanner met dubbele manometer.
- Snelkoppeling voor aankoppelen gas slang

Order nr.	829300205 €	
Orig. nr.	TIG200PAC	
Frequentie	Hz	50/60
Spanning	V	230 +/-10%
Inschakelduur (stroom @ 60%)	A	30
Maximum inschakelduur	A	200 @40%
Regelbereik	A	5-200
Opgenomen stroom 60%/maximum	A	200
Nullastspanning	V	56
Isolatieklasse		F
Beschermingsklasse	IP	21S
Capaciteit elektroden	mm	6
Geschikt voor alu		✓
lastype		TIG AC/DC
Gewicht	kg	12,00
Afmetingen (l x b x h)	mm	526 x 162 x 277
Prijs	€	1.349,00

NEW

HF

MMA

• DX50
connectie



• Ontspanner met
2 manometers



• 4m TIG toorts



• Lasroom

MACHINES



Set bestaande uit het lastoestel TIG200PAC, de lashelm PROTECT550 en de laswagen LKA700.

Order nr.

829300258

Orig. nr.

PACKTIG200PAC

Prijs

€

1.449,00

Plasma branders



Draagbare plasmasnijder.

Kenmerken:

- Snijdt gemakkelijk door 12 mm plaatdikte. Maximale snijdikte 25 mm
- Hoogfrequent (HF) opstarten
- Voor alle geleidende metalen zoals staal, aluminium, koper, inox, ...
- Zeer licht
- Ideaal voor moeilijk bereikbare plaatsen
- Hoge inschakelduur: 35% op 45 A
- Keuzeknop 2-takt/4-takt voor langdurig snijden
- Automatische Post flow voor afkoeling van de snijkop
- Ingebouwde automatische drukregelaar met display
- Met connector voor CNC-sturing van op pc
- CE en EMC conform
- IP23 geschikt voor gebruik op werven
- Beschermd tegen overbelasting en over- of onderspanning op het net

Geleverd met plasma toorts 6 m met snelkoppeling en massaklem 3 m.

Order nr.	829300220 €	
Orig. nr.		CUT45HF
Spanning	V	230
Maximum snijdikte	mm	19 (optimal: 12)
Maximum inschakelduur	A	35% @ 45
Regelbereik	A	20 ~ 45
Luchtverbruik	l/min	170
Werkdruk	bar	4,5
Maximum opgenomen vermogen	kW	7
Maximum opgenomen stroom	A	30,5
Nullastspanning	V	285
Kranchfactor	cos fi	0,99
Totale rendement	%	85
Isolatieklasse		F
Beschermingsklasse	IP	21S
Toorts		✓
Gewicht	kg	9,20
Afmetingen (l x b x h)	mm	439 x 165 x 327
Prijs	€	799,00



• 6m trofimet toorts met HF ontsteking

- Geïntegreerde manometer
- 2 takt/4 takt
- Stroomregeling

MACHINES

Hydraulische persen

Bepaal welke pers je nodig hebt

Pers, buig of maak uw werkstukken gemakkelijk recht met de krachtige hydraulische persen van MW TOOLS. Bouten of assen vervangen is nog nooit zo gemakkelijk geweest. De hydraulische atelierpersen zijn een must in elke garage of werkplaats! Op onze website vindt u atelierpersen om op uw werkbank of op de grond te installeren. Zoekt u pers voor kleine herstellingen? Dan past één van onze tafelpersen wellicht het beste bij u. Voor zwaardere werk raden we een vloermodel aan.

Welke capaciteit kies ik?

Persen helpen u om de noodzakelijke druk uit te oefenen op een materiaal. Afhankelijk van de kracht die u nodig hebt, bieden wij atelierpersen aan ideaal voor uw werkplaats. De hydraulische werkplaatspersen of garagepersen van MW TOOLS zijn beschikbaar met capaciteiten van 10T, 15T, 20T, 30T, 40T, 50T, 100T, 160T en 200T.

GEBRUIK

Montage, assemblage en reparatie
Algemene carrosserie
Zware carrosserie, landbouw en industrie

TONNAGE

10T - 15T - 20T
20T - 30T - 50T
20T - 100T - 160T - 200T

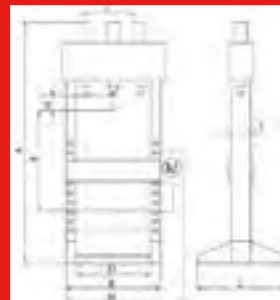

Hydraulische tafelpers met manuele bediening. 10 ton.

Compact en compleet tafelmodel.

Kenmerken:

- Met set V-blokken
- Met manometer op de cilinder
- Cilinder links/rechts verstelbaar.
- Cilinderkop demonteerbaar voor montage pensset.

Order nr. **754758310** €

Algemeen

Orig. nr.	CAT83010TS	
Type pers	manuele bediening	
Cilinder	mobiel	
Koers cilinder G	mm	160
Minimum werkstukafstand	mm	140
Capaciteit	t	10

Afmetingen

A	mm	1064
B	mm	474
C	mm	500
D	mm	340
E	mm	110
F	mm	370
G	mm	160
H	mm	620
I	mm	200
Gewicht	kg	60,00
Afmetingen (l x b x h)	mm	1000 x 675 x 270

Prijs € **284,00**



Hydraulische tafelpers met manuele bediening. 15 ton.

Kenmerken:

- Tafelmodel.
- Ideaal voor het assembleren of uitrechten van kleinere werkstukken.
- Gelaste constructie uit 1 stuk.
- Bewegbare cilinder en instelbare tafelhoogte.

Geleverd met:

- Manometer.
- V-blokken.

Optionele pensset beschikbaar.

Order nr. **757170150** €

Algemeen

Orig. nr.	PH15BT	
Type pers	manuele bediening	
Cilinder	mobiel	
Koers cilinder G	mm	152
Minimum werkstukafstand	mm	140
Capaciteit	t	15

Afmetingen

A	mm	1064
B	mm	474
C	mm	500
D	mm	340
E	mm	110
F	mm	370
G	mm	152
I	mm	200
Gewicht	kg	75,50
Afmetingen (l x b x h)	mm	1000 x 270 x 675

Prijs € **535,00**

ACCESSOIRES

p. 802

TOOLS



Hydraulische pers met manuele bediening. 20 ton.

Kenmerken:

- Eenvoudig model met fleskrík.
- Voorzien van 2 veren voor terugloop van de fleskrík.
- Tafel verstelbaar in de hoogte.

Geleverd met:

- Persblokken voor op de tafel.

Gedemonteerd geleverd.

Order nr.	754755200 €	
Algemeen		
Orig. nr.	CAT520	
Type pers	manuele bediening	
Cilinder	vast	
Koers cilinder G	mm	150
Minimum werkstukafstand	mm	150
Capaciteit	t	20
Afmetingen		
A	mm	1570
B	mm	610
C	mm	700
D	mm	495
E	mm	90
F	mm	880
G	mm	150
H	mm	610
Gewicht	kg	90,00
Afmetingen (l x b x h)	mm	610 x 700 x 1570
Prijs	€	235,00

TOOLS

ACCESSOIRES
p. 802

HYDROPNEUMATISCH



Hydraulische tafelpers met **hydropneumatische** bediening. 20 ton.

Kenmerken:

- Tafelmodel.
- Ideaal voor herhaal-toepassingen.
- Links-rechts verschuifbare cilinder.
- Bediening met manuele hendel of met voetpedaal op compressor aangesloten
- Robuust gelast frame.
- Overbelastingsventiel.
- Hard verchroomde as.

Geleverd met:

- Manometer.
- 2 V-blokken.

Optionele ponsenset en duwbrootsen leverbaar.

Order nr.	757170220 €	
Algemeen		
Orig. nr.	PPH20B	
Type pers	hydropneumatische bediening	
Cilinder	mobiel	
Koers cilinder G	mm	176
Minimum werkstukafstand	mm	45
Benodigde luchtdruk	bar	8
Capaciteit	t	20
Koers	mm	185
Snelheid neer onder druk	mm/min	62
Snelheid op onder druk	mm/min	370
Snelheid neer zonder druk	mm/min	185
Snelheid op zonder druk	mm/min	185
Afmetingen		
A	mm	1619
B	mm	630
C	mm	540
D	mm	510
E	mm	132
F	mm	736
G	mm	176
H	mm	800
I	mm	176
Gewicht	kg	151,00
Afmetingen (l x b x h)	mm	725 x 270 x 1740
Prijs	€	905,00

MACHINES

TOOLS



HYDROPNEUMATISCH

Hydraulische pers met **hydropneumatische** bediening. 50 ton.

Kenmerken:

- Links-rechts verschuifbare cilinder.
- Bediening ofwel manueel ofwel met voetpedaal op compressor aangesloten.
- Robuust gelast frame.
- Hydraulisch overbelastingsventiel.
- Verchroomde as.

Geleverd met:

- Manometer.
- 2 V-blokken
- handlier voor tafel verstelling

Optionele pensset en duwbrootsen leverbaar.

Optionele compressor leverbaar.

Order nr.	757170520 €	
Algemeen		
Orig. nr.	PPH50B	
Type pers	hydropneumatische bediening	
Cilinder	mobiel	
Koers cilinder G	mm	200
Benodigde luchtdruk	bar	8
Capaciteit	t	50
Koers	mm	202
Snelheid neer onder druk	mm/min	22
Snelheid op onder druk	mm/min	200
Snelheid neer zonder druk	mm/min	71
Snelheid op zonder druk	mm/min	71
Afmetingen		
A	mm	1850
B	mm	1030
C	mm	800
D	mm	730
E	mm	231
F	mm	848
G	mm	200
H	mm	1260
I	mm	245
Gewicht	kg	302,00
Afmetingen (l x b x h)	mm	910 x 228 x 1915
Prijs	€	1.895,00

ACCESSOIRES

p. 802

TOOLS



HYDROPNEUMATISCH

Hydraulische pers met **hydropneumatische** bediening. 75 ton.

Kenmerken:

- Links-rechts verschuifbare cilinder.
- Bediening ofwel manueel ofwel met voetpedaal om compressor aangesloten.
- Robuust gelast frame.
- Hydraulisch overbelastingsventiel.
- Verchroomde as.
- Automatische overgang tussen 2 snelheden.

Geleverd met:

- Manometer.
- 2 V-blokken
- handlier voor tafel verstelling

Optionele pensset en duwbrootsen leverbaar.

Optionele compressor leverbaar.

Order nr.	757170075 €	
Algemeen		
Orig. nr.	PPH75B	
Type pers	hydropneumatische bediening	
Cilinder	mobiel	
Koers cilinder G	mm	250
Benodigde luchtdruk	bar	8
Capaciteit	t	75
Koers	mm	250
Snelheid neer onder druk	mm/min	25
Snelheid op onder druk	mm/min	94
Snelheid neer zonder druk	mm/min	43
Snelheid op zonder druk	mm/min	43
Afmetingen		
A	mm	1896
B	mm	1140
C	mm	800
D	mm	800
E	mm	250
F	mm	884
G	mm	250
H	mm	260
I	mm	498
Gewicht	kg	498,00
Afmetingen (l x b x h)	mm	910 x 228 x 1915
Prijs	€	2.465,00



Industriële hydraulische pers met **hydropneumatische** bediening. 100 ton.

Kenmerken:

- Verplaatsbare cilinder.
- Robuust gelast frame uit 1 stuk. Heavy Duty.
- De pompbediening is manueel of met voetpedaal op compressor aangesloten
- Automatische overgang tussen 2 snelheden (snel zakken en traag persen).
- Verticaal verstelbare tafel met handlier.
- Links/rechts verplaatsbare cilinder met hendel op zware spindel.
- Tafel met slimme positioneringsstaven.
- Hydraulisch overbelastingsventiel.
- CE conform.

Geleverd met:

- Verzonken manometer
- 2 V-blokken.
- Hijslier voor tafelverstelling

Optionele ponsset en duwbrootsen leverbaar.

Order nr.	757170100	
Algemeen		
Orig. nr.	PPH100B	
Type pers	hydropneumatische bediening	
Cilinder	mobiel	
Koers cilinder G	mm	300
Capaciteit	t	100
Koers	mm	300
Snelheid neer onder druk	mm/min	13,5
Snelheid op onder druk	mm/min	94
Snelheid neer zonder druk	mm/min	200
Snelheid op zonder druk	mm/min	200
Afmetingen		
A	mm	1837
B	mm	1200
C	mm	990
D	mm	787
E	mm	300
F	mm	993
G	mm	300
I	mm	250
Gewicht	kg	766,00
Afmetingen (l x b x h)	mm	910 x 228 x 1915
Prijs	€	4.109,00



Hydraulische pers met **manuele bediening**. 20 ton.

Kenmerken:

- Standaard met 2-snelheden pomp.
- Deze pompunit kan zowel met de hand als met de voet bediend worden.
- De cilinder is mobiel en kan zowel naar links als naar rechts worden geplaatst.
- Hydraulisch overbelastingsventiel.
- Automatische terugkeer van de cilinder d.m.v. ingebouwde veer.
- Verchroomde as.
- Uitgerust met een windas voor het opheffen van de tafel.
- Mechanische verbinding van beide hendels.

Geleverd met:

- Manometer
- 2 drukplaten met vlakke kant en V aan de andere kant.

Geleverd zonder olie.

Zie technische gegevens atelierpersen.

Order nr.	757172020	
Algemeen		
Orig. nr.	CATOMA20S	
Type pers	manuele bediening	
Cilinder	mobiel	
Koers cilinder G	mm	160
Aantal snelheden		2
Capaciteit	t	20
Afmetingen		
A	mm	1750
B	mm	870
C	mm	650
D	mm	690
E	mm	180
F	mm	950
G	mm	160
H	mm	1010
Gewicht	kg	210,00
Afmetingen (l x b x h)	mm	1010 x 650 x 1750
Prijs	€	1.225,00

TOOLS

Hydraulische pers met manuele bediening. 30 ton.
Kenmerken:

- Standaard met 2-snelheden pomp.
- Deze pompunit kan zowel met de hand als met de voet bediend worden.
- De cilinder is mobiel en kan zowel naar links als naar rechts worden geplaatst.
- Hydraulisch overbelastingsventiel.
- Automatische terugkeer van de cilinder d.m.v. ingebouwde veer.
- Verchroomde as.
- Uitgerust met een windas voor het opheffen van de tafel.
- Mechanische verbinding van beide hendels.

Geleverd met:

- Manometer
- 2 drukplaten met vlakke kant en V aan de andere kant.

Geleverd zonder olie.

Zie technische gegevens atelierpersen.

Order nr.	757173030	
Algemeen		
Orig. nr.	CATOMA30S	
Type pers	manuele bediening	
Cilinder	mobiel	
Koers cilinder G	mm	160
Aantal snelheden		2
Capaciteit	t	30
Afmetingen		
A	mm	1920
B	mm	990
C	mm	650
D	mm	790
E	mm	200
F	mm	1030
G	mm	160
H	mm	1240
Gewicht	kg	280,00
Afmetingen (l x b x h)	mm	1250 x 650 x 1920
Prijs	€	2.094,00

TOOLS

Hydraulische pers met manuele bediening. 50 ton.
Kenmerken:

- Standaard met 2-snelheden pomp.
- Deze pompunit kan zowel met de hand als met de voet bediend worden.
- De cilinder is mobiel en kan zowel naar links als naar rechts worden geplaatst.
- Hydraulisch overbelastingsventiel.
- Automatische terugkeer van de cilinder d.m.v. ingebouwde veer.
- Verchroomde as.
- Uitgerust met een windas voor het opheffen van de tafel.
- Mechanische verbinding van beide hendels.

Geleverd met:

- 2 V-blokken
- Ingebouwde manometer

Geleverd zonder olie.

Zie technische gegevens atelierpersen.

Order nr.	757175050	
Algemeen		
Orig. nr.	CATOMA50T	
Type pers	manuele bediening	
Cilinder	mobiel	
Koers cilinder G	mm	150
Aantal snelheden		2
Capaciteit	t	50
Afmetingen		
A	mm	1920
B	mm	990
C	mm	650
D	mm	790
E	mm	210
F	mm	1015
G	mm	150
H	mm	1240
Gewicht	kg	430,00
Afmetingen (l x b x h)	mm	1250 x 800 x 2280
Prijs	€	2.389,00

TOOLS

Hydraulische pers met motorische bediening. 50 ton.
Kenmerken:

- Automatische 2-snelheden pomp.
- Zware uitvoering met vaste cilinder.
- Met hydraulisch overbelastingsventiel.
- Verchroomde as.
- Uitgerust met kabellier om de druktafel mee op te heffen.

Geleverd met:

- Manometer
- 2 V-drukplaten.

Geleverd zonder olie.

Order nr.	757160505	
Algemeen		
Orig. nr.	AGMCPM50	
Type pers	motorische bediening	
Cilinder	vast	
Koers cilinder G	mm	250
Aantal snelheden	2	
Motor	3x230/3x400 +/- 5%	
Capaciteit	t	50
Vermogen motor	kW	1,5
Beschermingsklasse	IP	54
Versnelling (traag)	mm/s	1,7
Versnelling (snel)	mm/s	20
Afmetingen		
A	mm	2290
B	mm	985
C	mm	650
D	mm	790
E	mm	210
F	mm	985
G	mm	250
H	mm	1380
Gewicht	kg	420,00
Afmetingen (l x b x h)	mm	1380 x 650 x 2290
Prijs	€	3.990,00

TOOLS

Hydraulische pers met motorische bediening. 100 ton.
Kenmerken:

- Automatische 2-snelheden pomp.
- Zware uitvoering met vaste cilinder.
- Met hydraulisch overbelastingsventiel.
- Verchroomde as.
- Uitgerust met kettingsysteem om de tafel op te heffen.

Geleverd met:

- Manometer
- 2 V-drukplaten.

Geleverd zonder olie.

Order nr.	757161010	
Algemeen		
Orig. nr.	AGMCPM100	
Type pers	motorische bediening	
Cilinder	vast	
Koers cilinder G	mm	320
Aantal snelheden	2	
Motor	3x230/3x400 +/- 5%	
Capaciteit	t	100
Vermogen motor	kW	1,5
Beschermingsklasse	IP	54
Versnelling (traag)	mm/s	1,5
Versnelling (snel)	mm/s	16
Afmetingen		
A	mm	2280
B	mm	1290
C	mm	850
D	mm	1030
E	mm	305
F	mm	760
G	mm	320
H	mm	1670
Gewicht	kg	950,00
Afmetingen (l x b x h)	mm	1670 x 850 x 2280
Prijs	€	6.460,00

TOOLS



Koers: 600mm

NEW

Hydraulische **brootspers** met motorische bediening. 15 ton.

Kenmerken:

- Brootspers met zeer lange koers van 600mm
- Ideaal voor intensief en professioneel gebruik
- De hoge koers van 600 mm laat toe om spiebanen in 1 per beweging uit te steken
- Bijna alle metaallegeringen kunnen in deze pers verwerkt worden
- Materialen: kunststoffen, staallegeringen, RVS, aluminium, hout, ...
- Stabiele gelaste constructie uit 1 stuk
- Handbediende olieklep voor op/neer beweging
- Regelknop voor perssnelheid
- Spanning 230 V
- Zware cilinder garandeert zeer hoge precisie
- Instelbare tafelhoogte met kettingen op de cilinder

Geleverd met:

- Manometer.

Optionele duwbrootsen zijn hiervoor op aanvraag leverbaar
Geleverd zonder hydraulische olie

Machines op maat zijn leverbaar op aanvraag

Order nr. **757161640** M

Algemeen		757161640 M
Orig. nr.		PM15V2
Type pers		motorische bediening
Cilinder		mobiel
Koers cilinder G	mm	600
Vermogen motor	kW	5,5
Spanning	V	3x400
Drukkraft	T	14,7
Oliedebiet	l/min	11,8
Inhoud olietank	l	35
Daalsnelheid	mm/sec	0 - 30
Terugkeersnelheid	mm/sec	0 - 40
Frequentie	Hz	50
Toerental	tpm	1500

Afmetingen

Diameter cilinder	mm	90
Diameter cilinderstang	mm	50
Diameter cilinderkop	mm	80
A	mm	2300
B	mm	820
C	mm	494
D	mm	650
E	mm	200
F	mm	1140
G	mm	100
H	mm	112
I	mm	900
J	mm	700
K	mm	110
Gewicht	kg	200,00
Prijs	€	5.100,00

TOOLS



ACCESSOIRES

p. 802

Hydraulische pers met motorische bediening. 100 ton.

Kenmerken:

- Ideaal voor intensief en professioneel gebruik.
- Zware, gelaste en stabiele constructie uit 1 stuk.
- Cilinder garandeert hoge precisie.
- Motorisch of manueel werken mogelijk.
- Instelbare tafelhoogte met kettingen op de cilinder.
- De motorische op/neer beweging laat toe om gemakkelijk spiegleuven te snijden.
- Optionele duwbrootsen zijn hiervoor op aanvraag.

• Modellen met 2 snelheden: bij het dalen schakelt de pomp automatisch over in lagere snelheid bij het vaststellen van tegendruk.

• Met vaste of beweegbare cilinder links/rechts.

• Modellen XL: extra brede uitvoering.

Geleverd met:

- Manometer.
- Forse tafel, die werken zonder V-blokken mogelijk maakt.

Geleverd zonder hydraulische olie. Optionele duwbrootsen leverbaar. Machines op maat zijn leverbaar op aanvraag.

Order nr. **757161614** E **757161616** E

Algemeen

Orig. nr.		PM100B2	PM100B2XL
Type pers		motorische bediening	motorische bediening
Cilinder		mobiel	mobiel
Koers cilinder G	mm	400	400
Aantal snelheden		2	2
Motor		3x400	3x400
Capaciteit	t	100	100
Vermogen motor	kW	2,2	2,2
Beschermingsklasse	IP	54	54
Versnelling (traag)	mm/s	2,47	2,47
Versnelling (snel)	mm/s	7,54	7,54
Spanning	V	3x400	3x400
Oliedebiet	l/min	5,64/17,2	5,64/17,2
Inhoud olietank	l	30	30
Frequentie	Hz	50/60	50/60
Toerental	tpm	3000	3000

Afmetingen

Diameter cilinder	mm	220	220
Diameter cilinderstang	mm	90	90
Diameter cilinderkop	mm	120	120
A	mm	2140	2140
B	mm	1350	1750
C	mm	755	755
D	mm	1100	1500
E	mm	300	300
F	mm	1665	2065
G	mm	150	150
H	mm	180	180
I	mm	750	750
Gewicht	kg	970,00	1145,00
Afmetingen (l x b x h)	mm	1665 x 780 x 2140	
Prijs	€	6.700,00	9.770,00

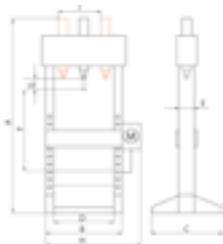

PM100/PM160

Hydraulische pers met motorische bediening. 160 ton.

Kenmerken:

- Ideaal voor intensief en professioneel gebruik.
- Zware, gelaste en stabiele constructie uit 1 stuk.
- Cilinder garandeert hoge precisie.
- Motorisch of manueel werken mogelijk.
- Instelbare tafelhoogte met kettingen op de cilinder.
- De motorische op/neer beweging laat toe om gemakkelijk spiegelleuven te snijden.
- Modellen met 2 snelheden: Bij het dalen schakelt de pomp automatisch over in lagere snelheid bij het vaststellen van tegendruk.
- Met vaste of beweegbare cilinder links/rechts.
- Modellen XL: extra brede uitvoering

Geleverd met:

- Manometer.
- Forse tafel, die werken zonder V-blokken mogelijk maakt.

Geleverd zonder hydraulische olie.

Optionele duwbrootsen leverbaar.

Machines op maat zijn leverbaar op aanvraag.

Order nr.	757161621 €	757161623 €	757161624 €
Algemeen			
Orig. nr.	PM160B2	PM160B2XL	PM160B2XLD
Type pers	motorische bediening	motorische bediening	motorische bediening
Cilinder	mobiel	mobiel	mobiel
Koers cilinder G	mm	400	400
Aantal snelheden		2	2
Motor	3x400	3x400	3x220
Capaciteit	t	160	160
Vermogen motor	kW	3	3
Beschermingsklasse	IP	54	54
Versnelling (traag)	mm/s	2,4	2,4
Versnelling (snel)	mm/s	7,48	7,48
Spanning	V	3x400	3x400
Oliedebiet	l/min	8,8/27,6	8,8/27,6
Inhoud olietank	l	30	30
Frequentie	Hz	50/60	50/60
Toerental	tpm	3000	3000
Afmetingen			
Diameter cilinder	mm	280	280
Diameter cilinderstang	mm	125	125
Diameter cilinderkop	mm	160	160
A	mm	2200	2270
B	mm	1410	1810
C	mm	825	825
D	mm	1100	1500
E	mm	380	380
F	mm	1725	2125
G	mm	150	150
H	mm	180	2300
I	mm	750	750
Gewicht	kg	1195,00	1430,00
Afmetingen (l x b x h)	mm	1725 x 935 x 2200	1725 x 935 x 2200
Prijs	€	9.810,00	12.940,00



Set ronde ponsen voor atelierpers.
Met adapter voor plaatsing op de cilinderkop.

De 100T set 757176661 wordt geleverd zonder tegendrukplaat.

Order nr.	Orig. nr.	Voor type	Diameter matrijzen mm	Prijs €
757176541	Ⓜ CATOMA20TM	CATOMA20S	5 - 10 - 14 - 18 - 24 - 29	173,00
757176561	Ⓜ CATOMA30TM	CATOMA30S	5 - 10 - 14 - 18 - 24 - 29	238,00
757176581	Ⓜ CATOMA50TM	CATOMA50T-MA50T-AG-MCPM50	5 - 10 - 14 - 18 - 24 - 29	265,00
757176661	Ⓜ V6661X100T	MCPM100-AG-MCPM150	5 - 10 - 14 - 18 - 24 - 29	130,00



Set 8 ronde duwmatrijzen voor CAT83010TS, PH15BT, PPH20B, PPH50B, PPH75B, PPH100B.

- Diameters: 10, 12, 16, 18, 20, 22, 25 en 30 mm.
- Passen met een adapter op de cilinderkop, en laten zo toe preciezer te persen.
- Gewicht: 7,5kg.

Order nr.	754758311	Ⓜ
Orig. nr.	CAT-SET	
Prijs	€	85,50



Spiebaan duwbrootsen

Met duwbrootsen maakt u in enkele bewegingen een spiegeluf in uw werkstuk.

Bestemd voor gebruik op een manuele of motorische atelierpers.
Bij voorkeur een machine met grote koers (bvb 400mm).

Kies de juiste duwbroots en geleidebus afhankelijk van de gewenste diameter van het asgat en dikte van de spiegeluf die u wilt maken.

Order nr.	Orig. nr.	Gleuf	Sleuf-breedte mm	Type	Diameter asgat mm	Prijs €
790008646	Ⓜ 790008646	I	2	duwbroots	-	125,00
790008647	Ⓜ 790008647	I	3	duwbroots	-	125,00
790008648	Ⓜ 790008648	II	4	duwbroots	-	151,00
790008649	Ⓜ 790008649	II	5	duwbroots	-	151,00
790008650	Ⓜ 790008650	III	5	duwbroots	-	172,00
790008651	Ⓜ 790008651	III	6	duwbroots	-	172,00
790008652	Ⓜ 790008652	III	8	duwbroots	-	172,00
790008653	Ⓜ 790008653	IV	10	duwbroots	-	255,00
790008654	Ⓜ 790008654	IV	12	duwbroots	-	255,00
790008655	Ⓜ 790008655	IV	14	duwbroots	-	255,00
790008656	Ⓜ 790008656	V	16	duwbroots	-	420,00
790008657	Ⓜ 790008657	V	18	duwbroots	-	420,00
790008658	Ⓜ 790008658	VI	20	duwbroots	-	749,00
790008659	Ⓜ 790008659	VI	22	duwbroots	-	749,00
790008660	Ⓜ 790008660	VI	24	duwbroots	-	749,00
790008661	Ⓜ 790008661	VI	25	duwbroots	-	749,00
790008662	Ⓜ 790008662	I	-	geleidebus	6	29,50
790008663	Ⓜ 790008663	I	-	geleidebus	7	29,50
790008664	Ⓜ 790008664	I	-	geleidebus	8	29,50
790008665	Ⓜ 790008665	I	-	geleidebus	9	29,50
790008666	Ⓜ 790008666	I	-	geleidebus	10	29,50
790008667	Ⓜ 790008667	II	-	geleidebus	11	28,50
790008668	Ⓜ 790008668	II	-	geleidebus	12	28,50
790008669	Ⓜ 790008669	II	-	geleidebus	13	28,50
790008670	Ⓜ 790008670	II	-	geleidebus	14	28,50
790008671	Ⓜ 790008671	II	-	geleidebus	15	28,50
790008672	Ⓜ 790008672	II	-	geleidebus	16	28,50
790008673	Ⓜ 790008673	II	-	geleidebus	17	28,50
790008674	Ⓜ 790008674	II	-	geleidebus	18	28,50
790008675	Ⓜ 790008675	II	-	geleidebus	19	28,50
790008676	Ⓜ 790008676	III	-	geleidebus	17	33,90
790008677	Ⓜ 790008677	III	-	geleidebus	18	33,90
790008678	Ⓜ 790008678	III	-	geleidebus	19	33,90
790008679	Ⓜ 790008679	III	-	geleidebus	20	33,90
790008680	Ⓜ 790008680	III	-	geleidebus	22	33,90
790008681	Ⓜ 790008681	III	-	geleidebus	24	33,90
790008682	Ⓜ 790008682	III	-	geleidebus	25	33,90
790008683	Ⓜ 790008683	III	-	geleidebus	26	33,90
790008684	Ⓜ 790008684	III	-	geleidebus	27	39,50
790008685	Ⓜ 790008685	III	-	geleidebus	28	39,50
790008686	Ⓜ 790008686	III	-	geleidebus	30	39,50
790008687	Ⓜ 790008687	III	-	geleidebus	32	39,50
790008688	Ⓜ 790008688	III	-	geleidebus	34	39,50
790008689	Ⓜ 790008689	III	-	geleidebus	35	39,50
790008690	Ⓜ 790008690	III	-	geleidebus	36	39,50
790008691	Ⓜ 790008691	IV	-	geleidebus	32	52,50
790008692	Ⓜ 790008692	IV	-	geleidebus	34	52,50
790008693	Ⓜ 790008693	IV	-	geleidebus	35	52,50
790008694	Ⓜ 790008694	IV	-	geleidebus	36	52,50
790008695	Ⓜ 790008695	IV	-	geleidebus	38	52,50
790008696	Ⓜ 790008696	IV	-	geleidebus	40	56,90
790008697	Ⓜ 790008697	IV	-	geleidebus	42	56,90
790008698	Ⓜ 790008698	IV	-	geleidebus	44	56,90
790008699	Ⓜ 790008699	IV	-	geleidebus	45	56,90

Knip- & plaatscharen

#metall-waif



• Lengteaanslag

Manuele precisie knipschaar.

Troeven:

- Compacte, maar uiterst stabiele constructie.
- Geharde staalmessen.
- Tafelmodel

Geschikt voor:

- Voor het snijden van metalen, papier, kunststof en andere materialen.

Geleverd met:

- Verstelbare achteraanslag
- Verstelbare hoekaanslag.

Order nr.	713776165	713776111
Orig. nr.	TBS650	TBS1050
Achteraanslag	mm 0 - 500	mm 0 - 500
Werkbreedte	mm 650	mm 1050
Plaatdikte	mm 1,25	mm 1,00
Gewicht	kg 100,00	kg 160,00
Afmetingen (l x b x h)	mm 970 x 470 x 540	mm 1570 x 480 x 580
Prijs	€ 879,00	€ 1.409,00

MACH

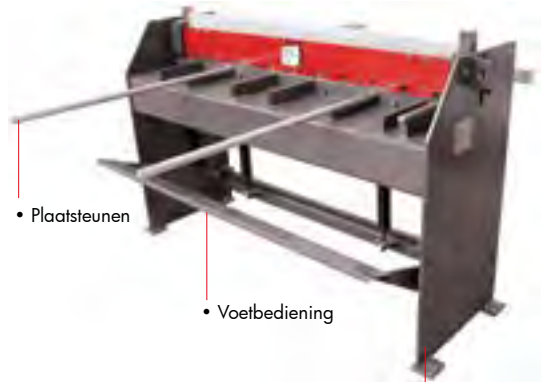

• Plaatsteunen

• Voetbediening

• Zwaar stalen gelast frame



Manuele stationaire knipschaar / plaatschaar op zwaar plaatstalen gelast frame.

Troeven:

- Zware plaatstalen gelast frame
- Voetbediening met pedaal van het mobiele bovenmes.
- Voorzien van twee krachtige veren
- Bovenmes onder hoek gepositioneerd voor een precieze snede
- Het omkeerbaar bovenmes kan in 4 posities gemonteerd worden, voor een langdurig optimaal snijresultaat.
- Transparante vingerbescherming

Geschikt voor:

- Werkplaats, onderhoudsdienst, scholen en opleidingscentra

Geleverd met:

- Manuele verstelbare achteraanslag met schaal aanduiding
- Plaatneerhouders
- 2 plaatsteunen vooraan met schaal aanduiding

Order nr.	800170108	800170110
Orig. nr.	SH127015	SH245010
Maximum plaatdikte	mm 1,2	mm 1,0
Maximum snijbreedte	mm 1270	mm 2450
Gewicht	kg 300,00	kg 500,00
Afmetingen (l x b x h)	mm 1600 x 750 x 1100	mm 2750 x 750 x 1100
Prijs	€ 1.795,00	€ 2.565,00

MACHINES



Gemotoriseerde plaatschaar met gemotoriseerde achteraanslag en digitale positieaanduiding.

Troeven:

- Gemotoriseerde achteraanslag over kogelomloopspindels
- Digitale weergave van de positie van de lengteaanslag
- Voetpedaalbediening
- Dubbel, gegraveerde snijdikteinstelling, eenvoudig te verstellen door middel van een zeskantsleutel

Geschikt voor:

- Werkplaats, onderhoudsdienst, scholen en opleidingcentra
- het snijden van platen van diverse materialen zoals plaatstaal, roestvrij staal, aluminium, etc. (Hou rekening als u wenst roestvrij staal te knippen dat u ongeveer een 30% minder knijpcapaciteit overhoudt.

Kenmerken:

- Robuuste machine vervaardigt uit gelaste plaatstalen constructie.
- Krachtige motor
- Hoogwaardige kwaliteitsmessen voor het snijden van staal, met 4 snijzijden
- Verschillende modi (3) mogelijk:
 - Een snede waarbij het bovenmes in onderste positie blijft
 - Enkelvoudige snede, bovenmes keert terug naar oorspronkelijke positie
 - Continue snede

Veiligheden:

- Lichtgordijn aan de achterzijde
- Vingerbescherming vooraan
- Voetpedaal bediening met aparte noodstop
- Nullastspanning
- Uitgerust met reset knop, om na activatie van één van de vele veiligheidsmaatregelen, de machine te resetten.
- Elektrische kast met Siemens componenten, alle bedrading genummerd.
- Motorbeveiliging voor alle motoren
- Bedieningspaneel met afzonderlijke noodstop, start en stopknop
- Vergrendelbare hoofdschakelaar

Order nr.		800170150 ^M	800170155 ^M	800170160 ^M
Orig. nr.		MMS1250X3.5	MMS2000X3.2	MMS3050X3.2
Vermogen motor	kW	5,5	7,5	11
Spanning	V	3x400, 50Hz	3x400, 50Hz	3x400, 50Hz
Snijhoek	°	1°30'	1°30'	1°
Snijcapaciteit in staal 37	mm	3,5	3,2	3,2
Snijcapaciteit in roestvrijstaal	mm	2,5	2,2	2,2
Snijlengte	mm	1.250	2.000	3.050
Aantal slagen per minuut		47	47	47
Maximum aantal snedes per minuut		10	10	10
Lengte ondersteuningsarmen	mm	900	900	900
Lengte achteraanslag	mm	650	650	650
Hoogte werktafel	mm	800	800	800
Gewicht	kg	1440,00	2000,00	2350,00
Afmetingen (l x b x h)	mm	1860 x 2100 x 1180	2624 x 2100 x 1180	3600 x 2100 x 1180
Prijs	€	10.990,00	12.590,00	17.410,00

MMS1250X3,5 MMS2000X3,2



- Gegraveerde plaatdikte instelling



- Lichtgordijn
- Gemotoriseerde achteraanslag met kogelomloopspindel



Geleverd met:

- Ondersteuningsarmen met mm/inch schaalverdeling
- Bedieningsleutels
- Nederlandstalige handleiding, opschriften, CE - kenmerk, en CE-attest volgens Machine richtlijn 2006/42/CE, Laagspanningsrichtlijn 2006/95/CE en EMC Richtlijn 2004/108/CE

Tip: Installatie, ingebruikname en scholing door gekwalificeerde technici op aanvraag

Kogellagerpersen

OPTIMUM

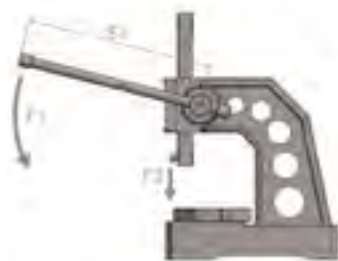

Kogellagerpersen.

Troeven:

- Stabiele constructie
- Lichaam uit hoogwaardig gietijzer
- Variabel instelbare trekstang
- 4-weg positioneerbare grondplaat
- 4 verschillende uitvoeringen

Geschikt voor:

- het markeren, in- en uitpersen van lagers, doornen, bussen, spindels, stiften, etc.

Tip: Te bevestigen op een werkbank

Order nr.	790025111	790025112	790025113
	M	M	M
Orig. nr.	DDP10	DDP20	DDP30
Capaciteit	t 1	2	3
Uitlading	mm 95	125	150
Maximum werkstukhoogte	mm 123	195	310
Afmetingen ram (l x b x h)	mm 25x25x240	32x32x345	38x38x455
	392,4 N / 40	392,4 N /	392,4 N / 40
Handkracht (F1)	kg - 589 N /	40 kg - 589 /	kg - 589 N /
	60 kg	60 kg	60 kg
Lengte hefboom (S1)	mm 340	450	600
Ontwikkelde kracht (F2)	7480 N / 763	8364 N / 853	7705 N / 786
	kg - 11220 N	kg - 12555 N /	kg - 11566 N
	/ 1143 kg	1280 kg	/ 1179 kg
Gewicht	kg 14,00	33,00	55,00
Afmetingen (l x b x h)	mm 270 x 180	430 x 235	455 x 260
	x 410	x 680	x 850
Prijs	€ 95,50	183,00	290,00

Hefboom plaatscharen



Robuuste metaal plaatschaar.



Troeven:

- Robuust lichaam
- Precisie afgewerkt
- Gehard en geslepen messen
- Geschikt voor het knippen van staal tot 450 N/mm²
- In de hoogte verstelbare plaatneerhouder.
- Kan gemonteerd worden op werkbank, speciale verrijdbare trolley 731010002

Geschikt voor:

- Het knippen van staalplaat en assen
- Iedere metaal- en/of onderhoudswerkplaats
- Scholen- en opleidingscentra
- Thuiswerker
- Servicewagens

Geleverd met

- Zware overbrengingshendel
- Plaatneerhouder.

Order nr.	731010004	731010005	731010006
	M	M	M
Orig. nr.	BIR1BH4	BIR1BH5	BIR1BH6
Capaciteit snijden plat	mm 4	5	6
Capaciteit snijden rond	mm 10	11	13
Afmetingen mes	mm 120	150	180
Gewicht	kg 8,00	13,50	19,80
Prijs	€ 143,00	153,00	205,00



Robuuste metaal plaatschaar met lange messen



Troeven:

- Robuust lichaam
- **Meslengte van 300 mm of 500 mm**
- Precisie afgewerkt
- Gehard en geslepen messen
- Geschikt voor het knippen van staal tot 450 N/mm²
- In de hoogte verstelbare plaatneerhouder.
- Kan gemonteerd worden op werkbank, speciale verrijdbare trolley 731010002,

Geschikt voor:

- Het knippen van staalplaat en assen
- Iedere metaal- en/of onderhoudswerkplaats
- Scholen- en opleidingscentra
- Thuiswerker
- Servicewagens

Geleverd met:

- Zware overbrengingshendel
- Plaatneerhouder.

Order nr.	731013000	731015000
	M	M
Orig. nr.	BIR2BH300	BIR3BH500
Capaciteit snijden plat	mm 4	5
Capaciteit snijden rond	mm 13	13
Afmetingen mes	mm 300	500
Gewicht	kg 30,00	132,00
Prijs	€ 308,00	1.099,00



Robuuste plaat-, rondstaal en plaatneerhaarschaar.



Troeven:

- Robuust lichaam
- Precisie afgewerkt
- Gehard en geslepen messen
- Geschikt voor het knippen van staal tot 450 N/mm²
- In de hoogte verstelbare plaatneerhouder.
- Kan gemonteerd worden op werkbank, speciale verrijdbare trolley 731010002,

Geschikt voor:

- Het knippen van staalplaat, T- en L-profielen en rondstaal
- Iedere metaal- en/of onderhoudswerkplaats
- Scholen- en opleidingscentra
- Thuiswerker
- Servicewagens

Geleverd met:

- Zware overbrengingshendel
- Plaatneerhouder.

Order nr.	731024080	
Orig. nr.	BIR4RP/8	
Capaciteit snijden plat	mm	8
Capaciteit snijden rond	mm	16
Capaciteit T-profiel	mm	40x6
Capaciteit L-profiel	mm	40x6
Afmetingen mes boven	mm	186x80
Afmetingen mes onder	mm	170x80
Gewicht	kg	45,00
Prijs	€	579,00



Robuuste plaat-, rondstaal en profielschaar - heavy duty type



Troeven:

- Robuust lichaam
- Aandrijving van het knipmechanisme gebeurt met een tand-aandrijving.
- Precisie afgewerkt
- Gehard en geslepen messen
- Geschikt voor het knippen van staal tot 450 N/mm²
- In de hoogte verstelbare plaatneerhouder.
- Kan gemonteerd worden op werkbank, speciale verrijdbare trolley 731010002,

Geschikt voor:

- het knippen staalplaat, T- en L-profielen en rondstaal en vierkant staal
- Iedere metaal- en/of onderhoudswerkplaats
- Scholen- en opleidingscentra
- Thuiswerker
- Servicewagens

Geleverd met:

- Zware overbrengingshendel
- Plaatneerhouder.

Order nr.	731045010	
Orig. nr.	BIR5RP/10	
Capaciteit snijden plat	mm	10
Capaciteit snijden rond	mm	22
Afmetingen mes	mm	90x12
Capaciteit snijden vierkant	mm	20
Capaciteit T-profiel	mm	60x7
Capaciteit L-profiel	mm	60x7
Gewicht	kg	103,00
Prijs	€	1.399,00



Robuuste betonijzerschaar met tand-aandrijving van het knipmechanisme.

Troeven:

- Robuust lichaam
- Precisie afgewerkt
- Gehard en geslepen messen
- Met tandwieloverbrenging van het knipmechanisme.
- Kan gemonteerd worden op werkbank, speciale verrijdbare trolley 731010002,

Geschikt voor:

- Het knippen van betonstaal
- Iedere metaal- en/of onderhoudswerkplaats
- Scholen- en opleidingscentra
- Thuiswerker
- Servicewagens

Geleverd met:

- Zware overbrengingshendel

Order nr.	731035022	731035026
Orig. nr.	BIR50/22	BIR50/26
Capaciteit snijden plat	mm	22
Afmetingen mes	mm	35x35
Gewicht	kg	25,00
Prijs	€	214,00
		509,00



Verrijdbare trolley voor Birlksan metaalscharen.

Troeven:

- Universeel te gebruiken
- Robuust gebouwde trolley
- Verrijdbaar dankzij groot gedimensioneerde wielen
- Stevige hendel

Geschikt voor:

- Plaatscharen, betonscharen, ponsmachines van Birlksan of andere gelijkaardige toestellen

Order nr.	731010002	
Orig. nr.	BIRBH5001	
Gewicht	kg	42,00
Prijs	€	410,00

Plooiachines



Universeel plooi toestel voor het plooiën van metaalprofielen.

Troeven:

- Solide gietijzeren constructie.
- Bij plaatsing boven elkaar, kunnen meerdere profielen tegelijk geplooid worden.
- Compacte montage op werkbank door afneembare hendel.
- Met een set plooi blokken (voor verschillende bocht diameters en profielen).
- Plooihoek tot 120° met fijnafstelling.

Geschikt voor:

- alle profielen (plat, rond, ...) en materialen (inox, ijzer, betonijzer...).
- Iedere werkplaats, servicewagen

Geleverd met:

- hoekaanduiding, verschillende plooi blokken, aanslag voor repetitief werk en snelspanklem

Order nr.	757491070 €	
Orig. nr.	CAT10070	
Type plooiën	profiel	
Bediening	manueel	
Maximum plooihoek	°	120
Plat staal	mm	100x15
Capaciteit vierkant staal	mm	30
Capaciteit betonstaal	mm	30
Inox	✓	
Betonstaal	✓	
Staal	✓	
Voor werkbank	✓	
Gewicht	kg	33,00
Prijs	€	249,00



Draagbaar plooi toestel voor buizen tot 180°



Troeven:

- Draagbaar en klaar voor gebruik
- Ingebouwde klem voor montage op de werktafel.
- Bevat een set van 4 matrijzen.
- Krachtige overbrengingshendel
- Biedt ook mogelijkheid om materiaal te klemmen voor het zagen van stukken op maat.
- Gemakkelijk te vervoeren

Geschikt voor:

- assembleren van hydraulische verbindingen, voor loodgieters, garagisten enz.
- lichte buizen, zoals koper gegloeid staal en messing.

Order nr.	757491040 €	
Orig. nr.	1040	
Type plooiën	profiel	
Type	1040	
Set matrijzen voor het plooiën van buizen	mm	5-6 (radius 31) 8 (radius 33) 10 (radius 40) 12 (radius 40)
Maximum hoek van de bocht	°	180
Maximum wanddikte van het staal	mm	1
Andere materialen	mm	1,5
Gewicht	kg	7,00
Prijs	€	206,00



Universeel plooi toestel op voet voor plat en rond materiaal tot 180°.

Troeven:

- Gelaste staalplaatconstructie.
- Uitgerust met een meerrollende hefboom.
- Geleverd met 8 matrijzen voor plat materiaal.

Geschikt voor:

- het plooiën van allerlei vormen van plat en rond materiaal (handvaten, u-ringen, ronde haken, enz...)

Order nr.	757491090 €	
Orig. nr.	CAT10090V	
Type plooiën	profiel	
Bediening	manueel	
Maximum plooihoek	°	180
Plat staal	mm	8x30 - 6x50
Capaciteit rondstaal	mm	16
Capaciteit vierkant staal	mm	16x16
Capaciteit betonstaal	mm	12
Matrijzen plat staal	8	
Inox	✓	
Staal	✓	
Gewicht	kg	24,50
Prijs	€	139,00



CAT10090VACC. Vervangset van 8 matrijzen voor plat materiaal voor plooi machine CAT10090V.

Order nr.	757491099 €	
Orig. nr.	CAT10090VACC	
Prijs	€	62,90

metall-wafl



Universeel plooiroestel voor het plooiën van platte, rechthoekige en ronde vormen tot 180°. "Made in EU".

Troeven:

- Instelbare plooihoek aanslag voor een hoge herhaalnauwkeurigheid
- Uittrekbare hendel om een hogere hefkracht te genereren.
- Draagbaar en licht,
- Precieze afwerking
- Robuuste constructie
- Europese makelij

Geschikt voor:

- eenvoudige als complexe vormen te buigen evenals verscheidene gesloten vormen in koud metaal.
- het koud buigen tot een hoek van 180°
- in de werkplaats, op montage en in de servicewagen

Standaard geleverd met:

- 2 stel geharde plooirollen x ø 24/30/37/43/49/62/75 mm.
- Onderstel
- Afneembaar buigeelement
- Uittrekbare hendel

Tip: u kunt uw toestel uitrusten met tal van verschillende optionele toebehoren:

- Met het buigelement UB11, 71379011, kunnen ook spiralen geplooid worden, hierdoor kan men decoratieve leuningen, tuinmeubelen en decoratieve stukken maken voor binnen- en buitenshuis.
- Met de klemplaat, 713790004, kan deze ook op een bankschroef worden gemonteerd.
- Met de plooirollen set 10-180, 713790002 tot max. ø 200 mm.

Order nr.	757491011
Orig. nr.	UB10
Type plooiën	profiel
Bediening	hand
Maximum plooihoek	° 180
Plat staal - rondbuigen	mm 10x50
Plat - scherp buigen	mm 6x50
Capaciteit rondstaal	mm 16
Capaciteit vierkant staal	mm 16x16
Inox	✓
Staal	✓
Gewicht	kg 32,00
Prijs	€ 470,00

metall-wafl



Ombouwkit voor dunwandige buizen voor UB10. Laat toe om dunwandige buizen te plooiën zonder knikken.

Set bevat per maat de buigmal, de geleiding voor de hefboom en het hoekstuk. De kit kan eenvoudig worden gemonteerd op een bestaand plooiroestel type UB10. Bevat 6 sets: ø 14, 16, 18, 20, 22 en 25 mm. Op aanvraag andere diameters leverbaar.

Order nr.	713790006
Orig. nr.	3790006
Prijs	€ 775,00

metall-wafl



Accessoire 011 - Spiralen voor plooi machine UB10.

Order nr.	757491012
Orig. nr.	1011A
Prijs	€ 119,00

metall-wafl



Matrijzen voor plooi machine UB10. Voor het koud plooiën van verwarmings- en installatiebuizen G 3/8", G 1/2", G 3/4". De matrijzen worden verkocht per paar, u heeft steeds 1 grote en 1 kleine matrijs nodig per afmeting.

Order nr.	757491015
Orig. nr.	3790001
Matrijs 3/8" (extern 16,7 - 17,7mm)	mm 102
Matrijs 1/2" (extern 21 - 22mm)	mm 108
Matrijs 3/4" (extern 26,5 - 27,5mm)	mm 112
Prijs	€ 168,00

metall-wafl



Matrijzen voor plooi machine UB10. Voor het overhoeks plooiën met een max. breedte tot 50 mm en een max. dikte van 7 mm en voor het plooiën van rechthoekig staal tot 16 x 16 mm. Deze set is geschikt voor decoratieve smederij, maar ook voor algemeen smeedwerk. Bestaat uit 4 sets matrijzen.

Order nr.	757491018
Orig. nr.	3790002
Aantal matrijzen	8
Diameter	mm 110 - 150 - 175 - 200
Prijs	€ 280,00



Hydraulische buizenplooiër met vaste vleugel tot 2"

Troeven:

- Capaciteit 12T.
- Met manuele fleskrik met krachtige veren.
- Zwaar gelaste constructie
- Met vaste vleugel

Geslacht voor:

- op de werf, de doe-het-zelver
- koud buigen van gasbuizen tot 2"

Standaard geleverd met:

- 6 buigmallen 1/2", 3/4", 1", 1 1/4", 1 1/2", 2" (binnenmaat).

Tip: niet geschikt voor dunwandige buizen of vol materiaal.

Order nr.	757502212	€
Orig. nr.	CAT2212	
Type plooiën	profiel	
Inox	✓	
Staal	✓	
Koers pomp	mm	232
Matrijzen (geschikte wanddikte)	1/2" (2,75mm), 3/4" (2,75mm), 1" (3,25mm), 1 1/4" (3,25mm), 1 1/2" (3,5mm), 2" (3,5mm)	
Asgat	mm	20
Gewicht	kg	45,00
Prijs	€	164,00



Vervangmatrijzen voor buizenplooiër CAT2212 en CAT2216. 757501507 en 757510508 zijn enkel voor CAT2216 geschikt.

Order nr.	Orig. nr.	Maat inch	Prijs €
757501001	CAT2212/12	1/2	18,50
757501102	CAT2212/19	3/4	18,50
757501203	CAT2212/25	1	0,00
757501304	CAT2212/30	1 1/4	26,90
757501405	CAT2212/38	1 1/2	35,90
757501506	CAT2212/50	2	0,00
757501508	CAT2212/3	3	48,90



Hydraulische buizenplooiër met opklapbare vleugel tot 3"

Troeven:

- Krachtig toestel met een capaciteit van 16T
- Met manuele hydraulische piston
- Overdrukventiel
- Met opklapbare vleugel
- Voor horizontaal als verticaal gebruik
- Eenvoudig te transporteren

Geslacht voor:

- op de werf, algemene industrie
- koud buigen van gasbuizen tot 3" tot 180°

Standaard geleverd met:

- 8 buigmallen 1/2", 3/4", 1", 1 1/4", 1 1/2", 2", 2 1/2", 3".
- Onderstel

Tip: Niet geschikt voor dunwandige buizen of vol materiaal.

Order nr.	757502217	€
Orig. nr.	CAT2216	
Inox	✓	
Staal	✓	
Matrijzen (geschikte wanddikte)	1/2" (2,75mm), 3/4" (2,75mm), 1" (3,25mm), 1 1/4" (3,25mm), 1 1/2" (3,5mm), 2" (3,5mm), 2 1/2" (3,5mm), 3" (4mm)	
Asgat	mm	20
Gewicht	kg	67,00
Prijs	€	329,00

OPTIMUM

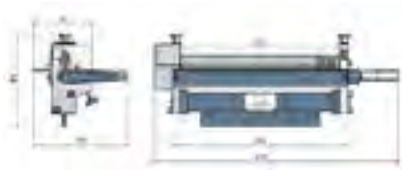

Mobiele rolmachine voor montage op bankschroef.

Troeven:

- Met 3 walsen.
- Regelschroeven voor materiaalsterkte.
- Geslepen buigrollen.

Geschikt voor:

- het gebruik op een bankschroef
- Buigen en rollen van draad, buizen 1 tot 5 mm, en platen
- Servicewagens, werkplaats

Tip: wordt geleverd zonder bankschroef, vergeet deze niet bij te bestellen.

Order nr.	713244030	
Orig. nr.		BM3
Diameter rollen	mm	30
Type plooiën		plaat
Maximum materiaalbreedte	mm	310
Minimum buigdiameter	mm	35
Maximum buigdiameter	mm	onbegrensd
Capaciteit buigen plaatstaal St.37	mm	1
Capaciteit buigen inox	mm	1
Capaciteit buigen alu/koper	mm	2
Capaciteit buigen messing	mm	1
Capaciteit buigen goud/zilver	mm	2
Capaciteit buigen buizen	mm	1-5
Gewicht	kg	10,00
Afmetingen (l x b x h)	mm	440 x 260 x 150
Prijs	€	183,00

OPTIMUM

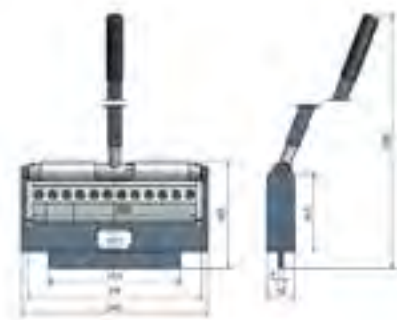

Mobiel zetbankje voor montage op bankschroef.

Troeven:

- Universeel inzetbaar.
- Zetbankje voor het plooiën van platen met uitneembare segmenten 150/75/50/25mm.
- Gemakkelijke draai beweging van de plooi malleen boven de hendelgreep.

Geschikt voor:

- gebruik op bvb bankschroef,
- plooiën van platen of bakjes
- servicewagens, werkplaats

Tip: wordt geleverd zonder bankschroef, vergeet deze niet bij te bestellen.

Order nr.	713244028	
Orig. nr.		FP30
Type plooiën		plaat
Maximum materiaalbreedte	mm	320
Maximum plaatdikte	mm	2,5
Maximum capaciteit rollen alu/koper	mm	300x2
Capaciteit plaatstaal	mm	300x1
Gewicht	kg	10,00
Afmetingen (l x b x h)	mm	440 x 220 x 90
Prijs	€	161,00

MACHINES

metallkraft



Klein handbediend vingerzetbank voor standaard plooiopdrachten.

Troeven:

- Eenvoudig design en solide constructie.
- Gegarandeerd spannen van de plaat door kleminrichting.
- Vluggе, gebruiksvriendelijke instelling van de bovenbalk over een excenter.
- Zwenkbeweging van de plooi balk gebeurt door middel van het handvat.
- Het bovenmes is hoog geplaatst voor het plooiën van hogere U-vormen.
- Het bovenmes is opgedeeld in 5 segmenten van 25/50/75/205/255mm en met mogelijke verstelling van de te plooiën plaatdikte.
- Uitlading van 25 mm.

Geschikt voor:

- het vervaardigen van kleine profielen, bvb. omranding van kasten.
- Instapmodel ideaal voor de doe-het-zelver of modelbouwer
- montage op een werkbank

Order nr.	713770610		
Orig. nr.	HSBM610HS		
Type plooiën	plaat		
Bediening	hand		
Maximum plooi breedte	mm	610	
Maximum plooi dikte staal	mm	1	
Maximum plooi hoek	°	135	
Staal	✓		
Gewicht	kg	42,00	
Afmetingen (l x b x h)	mm	850 x 360 x 420	
Prijs	€	345,00	

metallkraft



Handbediende zetbank met tal van uitbreidingsmogelijkheden. "Made in EU".

Troeven:

- Licht en verplaatsbaar.
- Hoogwaardige uitvoering en praktisch design.
- Het werkstuk kan perfect worden geklemd dankzij de speciale voorspanning van het bovenmes.
- Eenvoudige instelling van de plooihoek waardoor een goede herhalingsnauwkeurigheid kan worden bereikt.
- Zelfsmerende glijlagers.
- Tal van uitbreidingsmogelijkheden
- Europese makelij

Geschikt voor:

- gebruik op werven.

Tip: tal van uitbreidingsmogelijkheden

- Ook beschikbaar in lengtes 660 en 1300 mm (HSBM660N en HSBM1300N).
- De bovenbalk van dit toestel kan worden uitgerust met andere balken:
 - Type N: standaard, lage bovenbalk, doorlaat 25 mm
 - Type H: optioneel, verhoogde bovenbalk, doorlaat 95 mm
 - Type HS: optioneel, verhoogde, gesegmenteerde bovenbalk.
 - Type HSG: optioneel, verhoogde gesegmenteerde bovenbalk met voetje, perfect voor de dakdekker.
- Optioneel beschikbaar achteraanslag, rolschaar, scherpe plooi messen, rond plooi messen.

Order nr.	713771050		
Orig. nr.	HSBM1050N		
Type plooiën		plaat	
Bediening		hand	
Maximum plooi breedte	mm	1050	
Maximum plooi dikte staal	mm	1,25	
Maximum plooi hoek	°	135	
Inox	✓		
Staal	✓		
Gewicht	kg	71,00	
Afmetingen (l x b x h)	mm	1348 x 850 x 1175	
Prijs	€	1.145,00	

metallkraft

• Optionele kraalfunctie



• Plooiën en rolschaar 2 in 1



Manuele zetbank voor zink, ideaal voor de dakdekker op montage. "Made in EU".

Troeven:

- 2 machines in 1: hand zetbank en rolschaar.
- Afneembare rolschaar, maakt het precisie snijden van koper- en zinkplaat mogelijk.
- Plooi functie met garandeerde klemming van het werkstuk door voorspanning van de bovenbalk.
- Licht vervoerbaar, maar 120 kg.
- Stabiele constructie
- Hoekinstelling mogelijk van 0° tot 145°
- Rolschaar is uitgerust met een handvat om eenvoudig het apparaat te verplaatsen langsheen de plaat.

Geschikt voor:

- dakdekker op montage.
- het aanmaken van hoekbuigingen, schoorsteenbekledingen, etc.

Tip: kan uitgerust worden met een kraalfunctie, voor het plooiën van kralen, 713799002

Order nr.		713779200 
Orig. nr.		HSBM2200
Capaciteit plooiën	mm	2200
Maximum plooihoek	°	145
Maximum dikte staal	mm	0,7
Gewicht	kg	120,00
Afmetingen (l x b x h)	mm	2380 x 1050 x 1050
Prijs	€	2.249,00



FSBM1270-20E



FSBM1020-20HS2



Type	Segmenten
FSBM 1020-20HS2	25 - 30 - 35 - 40 - 45 - 50 - 75 - 100 - 150 - 200 - 270
FSBM 1020-25 E	25 - 30 - 35 - 40 - 45 - 50 - 75 - 100 - 150 - 200 - 270
FSBM 1270-20 E	25 - 30 - 35 - 40 - 45 - 50 - 75 - 100 - 150 - 200 - 250 - 270

Hand- en voetbediende zetbank / plooi bank met segmenten.

Troeven:

- Sterke uitvoering en compact design.
- Met gesegmenteerd bovenmes.
- Model FSBM1020-20 HS2 ook met ondersegmenten.
- Het aanspannen van het werkstuk gebeurt met de voet, beide handen blijven vrij.
- Met krachtige hulpveer.

Segmentindeling:

FSBM1020-20 HS2 25-30-35-40-45-50-75-100-150-200-270
 FSBM1020-25E 25-30-35-40-45-50-75-100-150-200-270

FSBM1270-20E 25-30-35-40-45-50-75-100-150-200-250-270

Geschikt voor:

- Universeel inzetbaar voor industrie en ambachtswerk.

Order nr.	713770125	713770102	713770127
Orig. nr.	FSBM1020-25E	FSBM1020-20HS2	FSBM1270-20E
Type plooiën	plaat	plaat	plaat
Bediening	hand en voet	hand en voet	hand en voet
Maximum plooi breedte	mm 1020	mm 1020	mm 1270
Maximum plooidikte staal	mm 2,5	mm 2	mm 2
Maximum plooihoek	° 135	° 135	° 135
Inox	✓	✓	✓
Staal	✓	✓	✓
Gewicht	kg 285,00	kg 300,00	kg 315,00
Afmetingen (l x b x h)	mm 1348 x 850 x 1175	mm 1348 x 850 x 1175	mm 1710 x 710 x 1310
Prijs	€ 1.595,00	€ 1.879,00	€ 1.850,00

metallkraft



speciale plooivormen

Magnetische plooi bank.

Troeven:

- Extreem lage werkstukhoogte mogelijk (bovenmes is slechts 15 mm hoog)
- Uiterst snelle en eenvoudige messenwissel door magneet.
- Mee vastklemmen van diverse buigmallen is mogelijk (rond, of driehoeken bvb)

Geschiedt voor:

- plaatmaterialen zoals staal, alu, inox, koper, zink, lood, ...

Kenmerken:

- Werking: het bovenmes klemt het werkstuk vast op de machinevoet via een sterke elektromagneet.
- Eenvoudig en snelle werkstukwissel en bediening.
- Plooi hoeken tot 170°.
- Perfecte klemming met een zuiver plooiresultaat tot in de hoeken.
- Bovenmes gesegmenteerd: 25 - 40 - 50 - 70 - 140 - 280 - 700 - 1250 mm

Standaard geleverd met:

- Hoekaanslag
- Achteraanslag
- 7-delig standaard bovenmes
- Breed en smal bovenmes voor scherpe hoeken
- Gegleufd bovemes
- Opbergvak voor messen
- Voetpedaal voor bediening van de magneet.

Opgepast: machine kan pacemakers beïnvloeden.

Order nr.		713770126
Orig. nr.		MBM1250
Type plooiën		plaat
Maximum plooi breedte	mm	1250
Capaciteit buigen inox	mm	1
Plooi capaciteit	T	6
Maximum dikte staal	mm	1,6
Gewicht	kg	150,00
Afmetingen (l x b x h)	mm	1400 x 410 x 390
Prijs	€	3.279,00

JOUANEL *industrie*

JOUANEL Industrie is een Franse fabrikant. Sinds 1948 ontwerpen, produceren en verkopen zij werktuigmachines voor plaatbewerking voor ambachtslieden en industriële klanten die gespecialiseerd zijn in dakbedekking, metalen bescherming van gebouwen, HVAC en thermische isolatie. Jouanel heeft een zeer flexibele productie en een perfecte technische controle. Jouanel ontwikkelt ook op maat gemaakte machines en volgt haar klanten op in hun projecten voor de uitrusting van complete snij, vorm en plooimachines. Zowel in Frankrijk als in het buitenland biedt Jouanel een grote selectie van producten aan en alle diensten die daarbij horen; een reactieve technische en commerciële ondersteuning, evenals de capaciteit voor het geven van advies en training.

PLOOIMACHINES
SNIJMACHINES
VOORMACHINES
...



www.jouanel.com



> Carpentry <



> Roofing <



> Zinc works <

Machines tools



Onze machines zijn ontworpen, geproduceerd en verstuurd vanuit onze fabriek in STE MAURE DE TOURAINE (Indre & Loire - Frankrijk). Daarvoor kregen we het label «Origin France Guaranteed» van het bureau Veritas.



> for building site & workshop <

JOLIANEL



Zetbank voor zink voor op de werf. Compleet uitgerust.

Troeven:

- Met zijn 39 kg een perfect mobiele plooi bank voor de werf !
- Met een opklapbare voet die indien nodig ook kan worden gedemonteerd.
- Plooieneus bovenmes met lichte hellingshoek.
- Brede oplegtafel van 15mm.
- Vrije uiteinden voor het vouwen van de randen bij 90 °
- Europese kwaliteit

Geschikt voor:

- Dakdekker op de werf
- Veeleisende doe-het-zelver

Standaard geleverd met:

- Rail voor de zinksnijder RCL1020B
- Zinksnijder CCM:
 - Aluminium behuizing
 - Geharde stalen messen voor een lange levensduur
 - Geleiding voor rail en 2 handvaten garanderen een precieze snede
 - Capaciteit zink 0,8 mm
- Kraalfunctie met kraal ø 18 mm ABH18-1020



Opmerking: min. Plooi breedte = 10-15 x materiaaldikte.

Order nr.		803771021
Orig. nr.		ZZB1020AB
Nuttige plooi lengte	mm	1020
Capaciteit in zink	mm	0,80
Capaciteit in staal S235JR	mm	0,60
Spanopening	mm	60
Zinksnijder		Standaard
Kraalfunctie		Standaard
Gewicht	kg	47,00
Afmetingen (l x b x h)	mm	1200 x 300 x 150
Prijs	€	1.890,00

JOLIANEL

Leisteenknipper - leiensnijder CA 600

NEW

Troeven:

- Vastmaken op latten en bevestigingspunten
- Vlug regelbare lengteaanslag voor alle rechte en andere sneden
- Verlengde tafel voor het plaats van leien tot maximaal 600 mm
- Van de fijnste fibro tot leisteen met een dikte van 6 mm dankzij versterkt mes
- Stalen kogelgelagerde geleiding

Geschikt voor:

- Dakdekkers op de werf
- Veeleisende doe-het-zelver



Tip: U kunt eventueel ook kiezen voor de samenklapbare leiensnijder CAREP, echter wel beperkt tot 3 mm.

Order nr.		803771204
Orig. nr.		CA600
Snijcapaciteit	mm	600
Snijbereik	mm	6
Gewicht	kg	22,00
Afmetingen (l x b x h)	mm	900 x 350 x 350
Prijs	€	715,00

JOJANEL

NEW

169KG



Zetbank voor zink met nuttige plooilengte van 2040 mm voor op de werf of in het atelier. Compleet uitgerust.

Troeven:

- Tegelijk lichte en robuuste structuur garandeert een perfect plooiresultaat
- Klemming 35°
- Oplegtafel 15 mm
- Gascylinder voor een gemakkelijke opening van de bovenklem
- Snelinstelling van de opening van de bovenklem dmv een excentriek
- Aanduiding van de hoekinstelling
- Hoekinstellingsaanslag voor seriematig plooiwerk
- Afneembare voeten

Geschikt voor:

- Dakdekker op de werf of in het atelier
- Professionele dakdekker

Standaard geleverd met:

- Rail voor de zinksnijder RCX2040A
- Zinksnijder CCM:
 - Aluminium behuizing
 - Geharde stalen messen voor een lange levensduur
 - Geleiding voor rail en 2 handvaten garanderen een precieze snede
 - Capaciteit zink 0,8 mm
- Kraalfunctie met kraal ø 18 mm ABH18-2040
- Pedaal over optimale klemming PCX2040A

Opmerking: min. Plooi breedte = 10-15 x materiaaldikte.

Tip: kies om uw toestel mobiel te maken met de optionele set wielen PCX2040A, tal van andere optionele accessoires beschikbaar zoals achteraanlagen, oplegtafels, etc, vraag bijkomende informatie aan onze binnendienst.

Order nr.	803771049 	
Orig. nr.	ZZB2040AB	
Nuttige plooilengte	mm	2040
Capaciteit in zink	mm	1
Capaciteit in staal S235JR	mm	0,80
Spanopening	mm	70
Zinksnijder	Standaard	
Kraalfunctie	Standaard	
Gewicht	kg	169,00
Afmetingen (l x b x h)	mm	2260 x 1040 x 600
Prijs	€	3.949,00

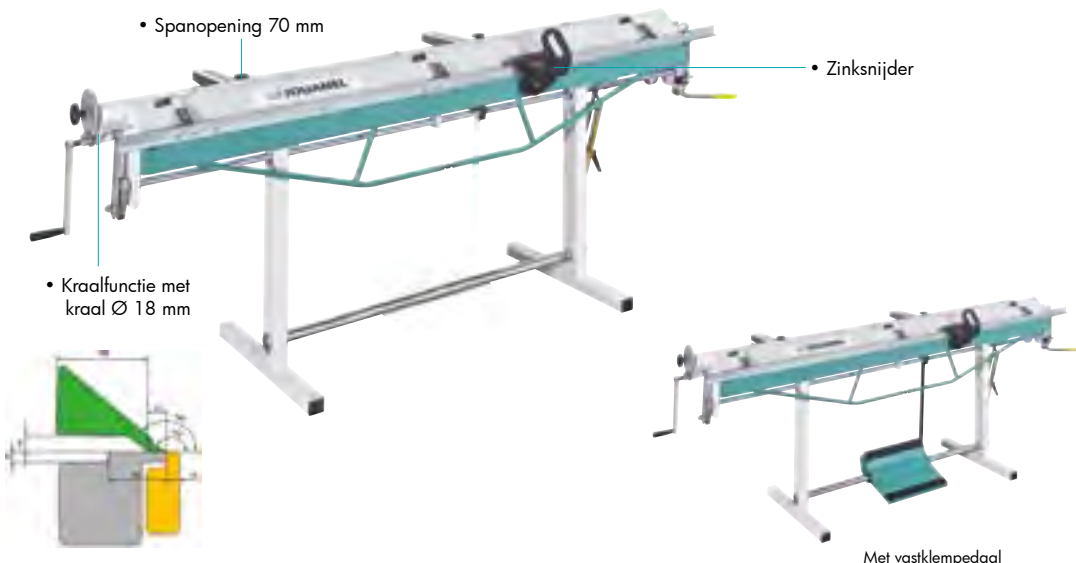

Zetbank voor zink met nuttige plooilengte van 2540 mm voor op de werf of in het atelier. Compleet uitgerust.

Troeven:

- Tegelijk lichte en robuuste structuur garandeert een perfect plooiresultaat
- Klemming 35°
- Oplegtafel 15 mm
- Gascylinder voor een gemakkelijke opening van de bovenklem
- Snelinstelling van de opening van de bovenklem dmv een excentriek
- Aanduiding van de hoekinstelling
- Tafel, klem en oplegtafel zijn instelbaar wat de nauwkeurigheid ten goede komt
- Hoekinstellingsaanslag voor seriematig plooiwerk
- Afneembare voeten

Geschikt voor:

- Dakdekker op de werf of in het atelier
- Professionele dakdekker

Standaard geleverd met:

- Rail voor de zinksnijder RCX2540A
- Zinksnijder CCM:
 - Aluminium behuizing
 - Geharde stalen messen voor een lange levensduur
 - Geleiding voor rail en 2 handvaten garanderen een precieze snede
 - Capaciteit zink 0,8 mm
- Kraalfunctie met kraal ø 18 mm ABH18-2540
- Pedaal over optimale klemming PCX2540A

Opmerking: min. Plooi breedte = 10-15 x materiaaldikte.

Tip: kies om uw toestel mobiel te maken met de optionele set wielen PCX2040A, tal van andere optionele accessoires beschikbaar zoals achteraanslagen, oplegtafels, etc, vraag bijkomende informatie aan onze binnendienst.

Order nr.		803771061
Orig. nr.		ZZB2540AB
Nuttige plooilengte	mm	2540
Capaciteit in zink	mm	0,80
Capaciteit in staal S235JR	mm	0,70
Spanopening	mm	70
Zinksnijder		Standaard
Kraalfunctie		Standaard
Gewicht	kg	249,00
Afmetingen (l x b x h)	mm	3100 x 1060 x 600
Prijs	€	5.090,00

JOUANEL

NEW

359KG



Zetbank voor zink met nuttige plooilengte van 3080 mm voor op de werf of in het atelier. Compleet uitgerust.

Troeven:

- Tegelijk lichte en robuuste structuur garandeert een perfect plooiresultaat
- Vertikale instellingsmogelijk van de oplegtafel garandeert het plooiën van de terugslagboord (druppelen van water).
- Klemming 35°
- Oplegtafel 15mm
- Gascylinder voor een gemakkelijke opening van de bovenklem
- Snelinstelling van de opening van de bovenklem dmv een excentriek
- Aanduiding van de hoekinstelling
- Tafel, klem en oplegtafel zijn instelbaar wat de nauwkeurigheid ten goede komt
- Hoekinstellingsaanslag voor seriematig plooiwerk
- Afneembare voeten

Geschikt voor:

- Dakdekker op de werf of in het atelier
- Professionele dakdekker

Standaard geleverd met:

- Rail voor de zinksnijder RCX3080A
- Zinksnijder CCM:
 - Aluminium behuizing
 - Geharde stalen messen voor een lange levensduur
 - Geleiding voor rail en 2 handvaten garanderen een precieze snede
 - Capaciteit zink 0,8 mm
- Kraalfunctie met kraal ø 18 mm ABH18-3080
- Pedaal over optimale klemming PCXP3040

Opmerking: min. Plooi breedte = 10-15 x materiaaldikte.

Tip: kies om uw toestel mobiel te maken met de optionele set wielen PCXR3040, tal van andere optionele accessoires beschikbaar zoals achteraanlagen, oplegtafels, etc, vraag bijkomende informatie aan onze binnendienst.

Order nr.	803771073	
Orig. nr.	ZZB3040AB	
Nuttige plooilengte	mm	3080
Capaciteit in zink	mm	1
Capaciteit in staal S235JR	mm	0,80
Spanopening	mm	80
Zinksnijder	Standaard	
Kraalfunctie	Standaard	
Gewicht	kg	359,00
Afmetingen (l x b x h)	mm	3860 x 1060 x 650
Prijs	€	6.900,00

MACHINES

Profielbuigmachines

metallcraft

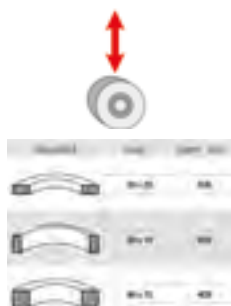

Standaard

NO.	WALS SET TYPE	GTW (mm)	Max. Diameter
1		100 200	100 150
2		200 x 2 300 x 2	100 150
3		300 x 2 400 x 2	100 150
4		400 x 2 500 x 2	100 150
5		500 x 2 600 x 2	100 150
6		600 x 2 700 x 2	100 150
7		700 x 2 800 x 2	100 150
8		800 x 2 900 x 2	100 150
9		900 x 2 1000 x 2	100 150

Optionele walsen set in ertalon voor PRM10M-voor meer info contacteer de verkoopprijs

Profielbuigmachine met manuele bediening.

Troeven:

- Tandwieloverbrenging
- Stabiele constructie en kan aan de grond vastgemaakt worden.
- Twee onderste walzen worden aangedreven door middel van een lier aan de achterzijde.
- Walzen zijn gehard en geslepen
- Assen zijn uit staal, gehard en geslepen.
- Vastzetten door het dichtdraaien van de bovenste wals.

Geschikt voor:

- Voor het walsen van vierkantmateriaal

Standaard geleverd met:

- Geharde set standaard walzen.
- Onderstel met opbergkast.

Order nr.	713940010	
Orig. nr.	PRM10M	
Diameter as	mm	28
Diameter wals boven	mm	98
Diameter wals onder	mm	115
Gewicht	kg	165,00
Afmetingen (l x b x h)	mm	620 x 560 x 1440
Prijs	€	979,00

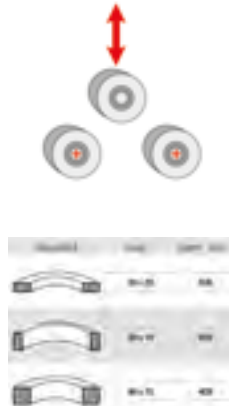

Standaard

Nr.	PROFIELTYPE	ASØ mm	Max. Diameter
1	[Profile]	30	100-150
2	[Profile]	20x18 20x22	100-150
3	[Profile]	20x18 20x22	100-150
4	[Profile]	20x22 20x28	100-150
5	[Profile]	20x22 20x28	100-150
6	[Profile]	20x28 20x34	100-150
7	[Profile]	20x28 20x34	100-150
8	[Profile]	20x34 20x40	100-150
9	[Profile]	20x34 20x40	100-150

Optionele walsenset in ertalon voor PRM10M voor meer info contacteer de verkoopdienst

Profielbuigmachine met 2 gemotoriseerde onderste walsen.

Troeven:

- Tandwieloverbrenging
- Stabiele constructie en kan aan de grond vastgemaakt worden.
- Twee onderste walzen worden aangedreven door middel van een lier aan de achterzijde.
- Walsen zijn gehard en geslepen
- Assen zijn uit staal, gehard en geslepen.
- Vastzetten door het dichtdraaien van de bovenste wals.
- Met twee aangedreven rollen door middel van een krachtige motor tweesnelheids motor.
- Kan zowel horizontaal als verticaal geplaatst worden.
- Voetpedaalbediening links / rechtslopend met tweede aparte noodstop
- Vergrendelbare hoofdschakelaar, aparte noodstop, start en stopknop.

Geschikt voor:

- Voor het walsen van vierkantmateriaal

Geleverd met:

- Geharde set standaard walsen.
- Onderstel met opbergkast.

NEW

Order nr.	713780012	713780011
Orig. nr.	PRM10E 1X230V	PRM10E 3X400V
Motorisch	✓	✓
Spanning	1 x 230	400
Vermogen motor	1,1	1,1
Snelheid	9	8
Diameter as	30	30
Diameter wals boven	98	98
Diameter wals onder	118	118
Gewicht	230,00	230,00
Afmetingen (l x b x h)	700 x 700 x 1400	700 x 700 x 1400
Prijs	€ 1.910,00	2.009,00



Optionele walsenset in nylon (ertalon) voor PRM10M of PRM10E.

- Een set wordt telkens op maat gemaakt voor 1 type profiel.
- Bij bestelling steeds de profielafmeting en het te verwerken materiaal opgeven.

Tip: hou rekening met het feit dat je per buisdiameter een andere set walsen nodig hebt.

Order nr.	800170225
Orig. nr.	PRM10M-R
Capaciteit	0-33,7
Prijs	€ 479,00



Profiel	Walsen	Walsen	Walsen	Walsen
	100-150	100-150	100	100
	100-150	100-150	100	100
	100-150	100-150	100	100
	100-150	100-150	100	100
	100-150	100-150	100	100

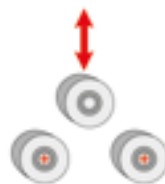

Profielbuigmachine met 2 aangedreven walsen voor horizontaal en verticaal gebruik.

Troeven:

- Zware gelaste constructie uit staal.
- Kan zowel horizontaal als verticaal geplaatst worden
- Twee onderste walsen worden direct motorisch aangedreven.
- Walsen uit gehard staal.
- Assen uit speciaal staal, gehard en geslepen.
- Manueel toezetten van de bovenste wals
- Zijdelingse richtrollen traploos regelbaar voor fijnafstelling.
- Uitgerust met een krachtige 400V motor
- Links / rechtslopend door middel van voetpedaalbediening
- Mobiele bedieningspaneel met voetpedaal
- Vergrendelbare hoofdschakelaar, start en stopknop, aparte noodstop

Geschikt voor:

- Werkplaats, scholen en opleidingscentra

Standaard geleverd met:

- Standaard rolwalsen
- Verplaatsbare voetpedaal met afzonderlijke noodstop
- Richtrollen
- Onderstel

Tip: Optioneel: digitale afstelling 713880075 en buigaccessoire voor spiralen 713880152

Order nr.	713812031	
Orig. nr.	PRM31F	
Motorisch	✓	
Spanning	V	400
Vermogen motor	kW	0,75
Snelheid	m/min	4
Diameter as	mm	30
Diameter wals boven	mm	148
Diameter wals onder	mm	118
Gewicht	kg	220,00
Afmetingen (l x b x h)	mm	600 x 800 x 1450
Prijs	€	2.875,00

 metall-wafl























Breidt uw werkbereik van uw profielwalsmachine PRM30F / **PRM31F** uit, met optionele walsen !

- Mogelijkheid om buizen of vierkante profielen te walsen.
- Hou rekening met het feit dat je per buisdiameter een andere set walsen nodig hebt.
- Als u aluminium of roestvrij staal wenst te walsen, kiest u best voor de kunststofrollen, dit om schade te voorkomen.
- Hieronder vindt u de meest voorkomende GAS buizen als vierkante profielen.

Staat uw buisafmeting hier niet tussen ?

Geen nood, wij helpen u graag verder, u dient enkel de buisdiameter en de wanddikte van uw buis op te geven. L, U, T-profielen op aanvraag.

Order nr.	Orig. nr.	Kwaliteit	Buis/Vierkant mm	Wanddikte mm	Prijs €
790611102 	3880077102	Staal	10,2 (1/8")	2	323,00
790611135 	3880077135	Staal	13,5 (1/4")	2,35	323,00
790611172 	3880077172	Staal	17,2 (3/8")	2,35	323,00
790611213 	3880077213	Staal	21,3 (1/2")	2,65	323,00
790611269 	3880077269	Staal	26,9 (3/4")	2,65	323,00
790611337 	3880077337	Staal	33,7 (1")	3,25	339,00
790611424 	3880078424	Staal	42,2 (1-1/4")	3,25	323,00
790611483 	3880078483	Staal	48,3 (1-1/2")	3,25	323,00
713880080 	3880080	Staal	30x30	3	399,00
713880081 	3880081	Staal	40x40	5	399,00
790612102 	3880082102	Kunststof	10,2 (1/8")	2	323,00
790612135 	3880082135	Kunststof	13,5 (1/4")	2,35	323,00
790612172 	3880082172	Kunststof	17,2 (3/8")	2,35	323,00
790612213 	3880082213	Kunststof	21,3 (1/2")	2,65	323,00
790612269 	3880082269	Kunststof	26,9 (3/4")	2,65	323,00
790612337 	3880082337	Kunststof	33,7 (1")	3,25	323,00
790612424 	3880083424	Kunststof	42,2 (1-1/4")	3,25	323,00
790612483 	3880083483	Kunststof	48,3 (1-1/2")	3,25	323,00
713880085 	3880085	Kunststof	30x30	3	399,00
713880086 	3880086	Kunststof	40x40	5	399,00

metalfast

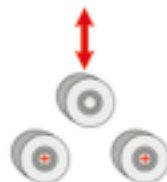

Walsen	Wals, gram	Wals, hoog. v.	Walsen	Wals, gram	Wals, hoog. v.
	60 x 30 60 x 30	100 100		10 x 30 x 1 60 x 60 x 1	1000 400
	100 x 25 60 x 30	400 150		10 x 10 x 0,5 10 x 30 x 0,5	1000 500
	70 x 30 20 x 30	800 300		Ø 20 Ø 30	400 400
	60 x 7 50 x 8	100 800		Ø 10 x 2 Ø 20 x 2	1000 800
	60 x 7 50 x 8	100 100		Ø 2 x 0,5 Ø 2 x 1,0	1000 100
	Ø 20 x 0,5 Ø 20 x 1	1000 100		10 x 1 60 x 1	1000 800
	Ø 20 x 0,5 Ø 20 x 1	1000 800		10 x 30 x 1 10 x 60 x 1	1000 1000
	60 x 7 50 x 8	800 800			

Standaard

Optioneel

Robuuste profielbuigmachine met twee aangedreven walsen voor horizontaal en verticaal gebruik.

Troeven:

- Zware gelaste constructie uit staal.
- Kan zowel horizontaal als verticaal geplatst worden
- Twee onderste walsen worden direct motorisch aangedreven.
- Walsen uit gehard en geslepen staal.
- Assen zijn eveneens uit staal, gehard en geslepen.
- Manueel toezetten van de bovenste wals
- Zijdelingse richtrollen traploos regelbaar voor fijnafstelling.
- Uitgerust met een krachtige motor 400V
- Links / rechtslopend door middel van voetpedaalbediening
- Vergrendelbare hoofdschakelaar, start en stopknop, aparte noodstop

Geschikt voor:

- Algemene industrie, betere werkplaats, scholen en opleidingscentra
- Trappen, sierpoorten, etc.

Standaard geleverd met:

- Sokkel
- Standaard rolwalsen voor plat / vierkant vol materiaal * (zie tabel)
- Verplaatsbare voetpedaal met afzonderlijke noodstop
- Richtrollen
- Onderstel

Tip: wordt zonder stekker aangeleverd, vergeet deze niet bij te bestellen

Order nr.	713812035	
Orig. nr.	PRM35F	
Motorisch	✓	
Spanning	V	3x400
Vermogen motor	kW	1,5
Snelheid	m/min	4,5
Diameter as	mm	50
Diameter wals boven	mm	155
Gewicht	kg	400,00
Afmetingen (l x b x h)	mm	750 x 1000 x 1400
Prijs	€	3.455,00





























Breidt uw werkbereik van uw profielwalsmachine **PRM35F** uit, met optionele walsen!

- Mogelijkheid om buizen of vierkante profielen te walsen.
- Hou rekening met het feit dat je per buisdiameter een andere set walsen nodig hebt.
- Als u aluminium of roestvrij staal wenst te walsen, kiest u best voor de kunststofrollen, dit om schade te voorkomen.
- Hieronder vindt u de meest voorkomende GAS buizen als vierkante profielen.

Staat uw buisafmeting hier niet tussen ?

Geen nood, wij helpen u graag verder, u dient enkel de buisdiameter en de wanddikte van uw buis op te geven. L, U, T-profielen op aanvraag.

Order nr.	Orig. nr.	Kwaliteit	Buis/Vierkant mm	Wanddikte mm	Prijs €
790601102 	3880089102	Staal	10,2 (1/8")	2,0	388,00
790601135 	3880089135	Staal	13,5 (1/4")	2,35	388,00
790601172 	3880089172	Staal	17,2 (3/8")	2,35	388,00
790601213 	3880089213	Staal	21,3 (1/2")	2,65	388,00
790601269 	3880089269	Staal	26,9 (3/4")	2,65	388,00
790601337 	3880089337	Staal	33,7 (1")	3,25	411,00
790601424 	3880090424	Staal	42,2 (1-1/4")	3,25	411,00
790601483 	3880090483	Staal	48,3 (1-1/2")	3,25	399,00
790601603 	3880091603	Staal	60,3 (2")	3,65	399,00
713880092 	3880092	Staal	30x30	3	399,00
713880093 	3880093	Staal	40x40	5	399,00
713880094 	3880094	Staal	50x50	6	395,00
790602102 	3880095102	Kunststof	10,2 (1/8")	2	345,00
790602135 	3880095135	Kunststof	13,5 (1/4")	2,35	345,00
790602172 	3880095172	Kunststof	17,2 (3/8")	2,35	345,00
790602213 	3880095213	Kunststof	21,3 (1/2")	2,65	345,00
790602269 	3880095269	Kunststof	26,9 (3/4")	2,65	345,00
790602337 	3880095337	Kunststof	33,7 (1")	3,25	345,00
790602424 	3880096424	Kunststof	42,2 (1-1/4")	3,25	345,00
790602483 	3880096483	Kunststof	48,3 (1-1/2")	3,25	345,00
790602603 	3880097603	Kunststof	60,3 (2")	3,65	345,00
713880098 	3880098	Kunststof	30x30	3	335,00
713880099 	3880099	Kunststof	40x40	5	335,00
713880100 	3880100	Kunststof	50x50	6	335,00



Standaard

Optioneel

Hydraulische profielbuigmachine met 3 aangedreven walsen voor profielen en buizen met voetpedaalbediening.

Troeven:

- Zware gelaste stalen constructie met 3 ketting-aangedreven walsen.
- Bovenste wals wordt hydraulisch versteld om de buigdiameter te bepalen.
- Walsen uit gehard en geslepen staal.
- Zijdelingse richtrollen traploos regelbaar voor buigen van spiralen.
- Aparte bedieningspaneel met aparte noodstop en voetbediening voor links en rechtslopend.
- Vergrendelbare hoofdschakelaar.
- Krachtige 400V-motor.

Geschikt voor:

- Horizontaal en verticaal gebruik voor het plooiën van diverse soorten profielen in staal, inox, ...
- Algemene industrie, betere werkplaatsen, scholen en opleidingscentra, etc.

Standaard geleverd met:

- onderbouw
- standaard rolwalsen (zie tabel)
- voetbediening

Tip: Optioneel verkrijgbaar: walsensets voor diverse soorten profielen, digitale aflezing voor de toezetwals, 713880101, hierdoor wordt de plooiwals elektronisch gepositioneerd, waardoor een hogere herhaalnaauwkeurigheid kan bekomen worden, zijdelingse richtrollen voor hoekijzer, 713880102.

Order nr.	713812036 M	
Orig. nr.	PRM50FH	
Motorisch	✓	
Spanning	V	3x400
Vermogen motor	kW	1,1
Snelheid	m/min	4,5
Diameter as	mm	50
Diameter wals boven	mm	162
Diameter wals onder	mm	152
Gewicht	kg	510,00

ANDERE MODELLEN
OP VYNCKIER.BIZ



PRM40FH



PRM80FH

metallwerk



Breidt uw werkbereik van uw profielwalsmachine **PRM50FH** uit, met optionele walsen!

- Mogelijkheid om buizen of vierkante profielen te walsen.
- Hou rekening met het feit dat je per buisdiameter een andere set walsen nodig hebt.
- Als u aluminium of roestvrij staal wenst te walsen, kiest u best voor de kunststofrollen, dit om schade te voorkomen.
- Hieronder vindt u de meest voorkomende GAS buizen als vierkante profielen.

Staat uw buisafmeting hier niet tussen ?

Geen nood, wij helpen u graag verder, u dient enkel de buisdiameter en de wanddikte van uw buis op te geven. L, U, T-profielen op aanvraag.

Order nr.	Orig. nr.	Capaciteit rond mm	Omschrijving	Capaciteit vierkant mm	Prijs €
713880103	3880103	0-33,7	staalrollen		492,00
713880104	3880104	34-48,3	staalrollen		492,00
713880105	3880105	49-60,3	staalrollen		492,00
713880106	3880106		staalrollen	30x30x3	478,00
713880107	3880107		staalrollen	40x40x5	478,00
713880108	3880108		staalrollen	50x50x6	478,00
713880109	3880109		staalrollen	60x60x6	478,00
713880110	3880110	0-33,7	plasticrollen		421,00
713880111	3880111	34-48,3	plasticrollen		421,00
713880112	3880112	49-60,3	plasticrollen		421,00
713880113	3880113		plasticrollen	30x30x3	421,00
713880114	3880114		plasticrollen	40x40x5	421,00
713880115	3880115		plasticrollen	50x50x6	421,00
713880116	3880116		plasticrollen	60x60x6	421,00

Voormachines

metalfast

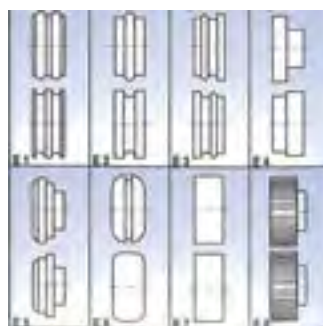

Accessoires

MACHINES

Manuele voormachines

Troeven:

- Handig en simpel
- Zware en gietijzeren constructie-
- Onderste wals is verstelbaar
- Stalen schachten

Standaard geleverd met:

- SBM110-08 met standaardrollen voor \varnothing 3/6/8/10 mm
- SBM140-12 met standaardrollen voor \varnothing 4/6/7/9/10 mm

Mogelijke accessoires op aanvraag:

- Rollen voor type E1 / E2 / E3 / E4 / E5 / E6 / E7 / E8 zie bijhorende afbeeldingen

Order nr.		713814001	713814002
Orig. nr.		SBM110-08	SBM140-12
Walsenlengte	mm	110	140
Plaatdikte max.	mm	1.2	0.8
Walsen diameter	mm	52	62
Uitlading (halsbreedte)	mm	80	100
Gewicht	kg	30,00	50,00
Afmetingen (l x b x h)	mm	380 x 180 x 350	560 x 220 x 500
Prijs	€	589,00	795,00

Plaatrolmachines

metall-wafl



RBM305



RBM610

Plaatrolmachine met 3 rollen

Troeven:

- Walsen uit hoogwaardig staal.
- Uitzwenkbare bovenwals voor gemakkelijker wegnemen van het werkstuk.
- Achterste wals is schuin verstelbaar voor het conisch ronden.
- Onderste en achterste wals met draadinleggleuf.
- Aandrijving van de walsen via handhendel en tandwielen.

Geschikt voor:

- Eenvoudig werk op werven, voor standenbouwers, enz.
- Het plooiën van buizen, kegels, cilinders,...
- Door de kleine dikte van de walsen optimaal geschikt voor "filigran" toepassingen.

- Groot gedimensioneerde walzenstelschroeven



Tip: Optioneel leverbaar onderstel 713940113.

Order nr.		713940112 ^M	713780618 ^M
Orig. nr.		RBM305	RBM610-8
Werkbreedte	mm	305	610
Diameter rollen	mm	25	38
Plaatdikte	mm	0,80	0,80
Minimum roldiameter	mm	40	60
Gewicht	kg	14,00	40,00
Afmetingen (l x b x h)	mm	580 x 210 x 255	885 x 220 x 340
Prijs	€	179,00	321,00

metall-wafl



Onderbouw voor manueel tafel plaatroltoestel RBM305 en RBM610-8

Order nr.		713940113 ^M
Orig. nr.		3780113
Prijs	€	89,50

metalfast



Manuele plaatrolmachine met 3 asymmetrische rollen.

Troeven:

- Wegdraaibare bovenrol voor het gemakkelijk uitnemen van het werkstuk.
- Asymmetrische rolinstelling voor het gemakkelijk voorbuigen.
- Achterrol kan schuin worden ingesteld voor conisch rollen.
- Voor- en achterrol voorzien van een draad-inleg.
- Eenvoudig instelbare boven- en onderrol.
- Aandrijving van de rollen door een hendel met tandwielaandrijving.

Geschikt voor:

- Industrie en ambachtwerk.
- Het vervaardigen van ronde vormen zoals buizen, kegels, cilinders, enz.

Standaard geleverd met:

- onderstel

Order nr.		713781301
Orig. nr.		RBM1000-20 ECO
Werkbreedte	mm	1000
Diameter rollen	mm	60
Plaatdikte	mm	2,0
Minimum roldiameter	mm	100
Gewicht	kg	240,00
Afmetingen (l x b x h)	mm	1542 x 550 x 1040
Prijs	€	1.395,00

metallcraft

• Hendel met tandwielaandrijving

• 3 symetrische rollen

• Wegdraaibare bovenrol

• Inclusief onderstel



Manuele plaatrolmachine met 3 asymetrische rollen.

Troeven:

- Wegdraaibare bovenrol voor het gemakkelijk uitnemen van het werkstuk.
- Asymetrische rolinstelling voor het gemakkelijk voorbuigen.
- Achterrol kan schuin worden ingesteld voor conisch rollen.
- Voor- en achterrol voorzien van een draad-inleg.
- Eenvoudig instelbare boven- en onderrol.
- Aandrijving van de rollen door een hendel met tandwielaandrijving.

Geschikt voor:

- Industrie en ambachtwerk.
- Het vervaardigen van ronde vormen zoals buizen, kegels, cilinders, enz.

Standaard geleverd met:

- onderstel

Order nr.		713813103 M
Orig. nr.		RBM1050.22
Werkbreedte	mm	1050
Diameter rollen	mm	75
Plaatdikte	mm	2,0
Minimum roldiameter	mm	115
Gewicht	kg	300,00
Afmetingen (l x b x h)	mm	1400 x 700 x 1160
Prijs	€	1.589,00



Gemotoriseerde plaatrolmachine met 3 asymmetrische rollen en voetpedaalbediening voor de industrie en ambacht.

Troeven:

- Zware en stabiele gietijzerenconstructie
- Asymmetrische 3 rollensysteem voor het correct voorbuigen
- Zwenkbare bovenwals
- Plaatdiktes opgegeven materiaal treksterkte tot 400N/mm².
- Voor het konisch buigen factor 0,5; voor roestvrij staal factor 0,75 en voor alu 1,2
- Krachtige 400V motor
- Boven en onderwals zijn aangedreven
- Elektrische uitrusting met degelijke componenten.

Geslacht voor:

- betere werkplaats, algemene industrie, scholen en opleidingscentra

Veiligheden:

- Beveiligingsperimeter met noodstopfunctie
- Vergrendelbare hoofdschakelaar
- Door de voetpedaalbediening met noodstop blijven beide handen vrij om het materiaal aan te voeren.
- Nederlandstalige handleiding, opschriften, CE-kenmerk, en CE attest volgens Machine richtlijn 2006/42/CE, laagspanningsrichtlijn 2006/95/CE en EMC Richtlijn 2004/108/CE

Tip: Optioneel zijn nog volgende zaken te verkrijgen: gemotoriseerd toezetten van de achterste rol en digitale weergave van de toezetrol. Optioneel geharde rollen te verkrijgen (ST 1050 hoge drukstaal)

Order nr.		713813201	713813202	713813203	713813204
Orig. nr.		RBM1050-30E	RBM1270-25E	RBM1550-20E	RBM2050-15E
Werkbreedte	mm	1050	1270	1550	2050
Diameter rollen	mm	90	90	90	95
Plaatdikte	mm	3,0	2,5	2,0	1,5
Vermogen motor	kW	1,1	1,1	1,5	1,5
Spanning	V	400	400	400	400
Rolsnelheid	m/min	6	6	6	6
Gewicht	kg	480,00	520,00	580,00	715,00
Afmetingen (l x b x h)	mm	1630 x 700 x 1200	1850 x 700 x 1200	2130 x 700 x 1200	2630 x 700 x 1200
Prijs	€	4.415,00	4.645,00	4.819,00	5.610,00

trastall-staff



RMB E PRO

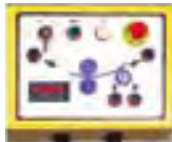

Gemotoriseerde plaatrolmachine met 3 asymmetrische rollen en voetpedaalbediening voor de industrie en ambacht.

Troeven:

- Zware en stabiele gietijzerenconstructie
- Asymmetrische 3 rollensysteem voor het correct voorbuigen
- Zwenkbare bovenwals
- Plaatdiktes opgegeven materiaal treksterkte tot 400N/mm².
- Voor het konisch buigen factor 0,5; voor roestvrij staal factor 0,75 en voor alu 1,2
- Krachtige 400V motor
- Boven en onderwals zijn aangedreven
- Elektrische uitrusting met degelijke componenten.

Geschikt voor:

- betere werkplaats, algemene industrie, scholen en opleidingscentra

Veiligheden:

- Beveiligingsperimeter met noodstopfunctie
- Vergrendelbare hoofdschakelaar
- Door de voetpedaalbediening met noodstop blijven beide handen vrij om het materiaal aan te voeren.
- Nederlandstalige handleiding, opschriften, CE-kenmerk, en CE attest volgens Machine richtlijn 2006/42/CE, Laagspanningsrichtlijn 2006/95/CE en EMC Richtlijn 2004/108/CE

Tip: vergeet uw mogelijke optionele toebehoren niet bij te bestellen:

- Geharde walsen voor inox.
- Gemotoriseerd toe zetten van de achterste rol.
- Digitale weergave van de toezet wals.

Order nr.		713813301 ^M	713813302 ^M	713813303 ^M
Orig. nr.		RBM1270-40E PRO	RBM1550-40E PRO	RBM2050-30E PRO
Diameter rollen	mm	120	140	130
Lengte rollen	mm	1270	1550	2050
Minimum roldiameter	mm	180	210	195
Vermogen motor	kW	2.2	2.2	2.2
Spanning	V	3x400	3x400	3x400
Rolsnelheid	m/min	3	3.5	3.5
Maximum plaatdikte Alu (250N/mm ²)	mm	5.2	5.2	3.9
Maximum plaatdikte (400N/mm ²)	mm	4	4	3
Gewicht	kg	1115,00	1420,00	1450,00
Afmetingen (l x b x h)	mm	2470 x 750 x 1000	2470 x 750 x 1000	3200 x 750 x 1000



Zware, gemotoriseerde plaatrolmachine met 3 asymmetrische rollen en voetpedaalbediening voor de industrie en ambacht.

Troeven:

- Zware en stabiele gietijzerenconstructie
- Asymmetrische 3 rollensysteem voor het correct voorbuigen
- Zwenkbare bovenwals
- Plaatdiktes opgegeven materiaal treksterkte tot 400N/mm².
- Voor het konisch buigen factor 0,5; voor roestvrij staal factor 0,75 en voor alu 1,2
- Krachtige 400V motor
- Boven en onderwals zijn aangedreven
- Elektrische uitrusting met degelijke componenten.

Geschikt voor:

- ketelbouw, betere werkplaats, algemene industrie, scholen en opleidingscentra

Veiligheden:

- Beveiligingsperimeter met noodstopfunctie
- Vergrendelbare hoofdschakelaar
- Door de voetpedaalbediening met noodstop blijven beide handen vrij om het materiaal aan te voeren.
- Nederlandstalige handleiding , opschriften , CE-kenmerk , en CE attest volgens Machine richtlijn 2006/42/CE, Laagspanningsrichtlijn 2006/95/CE en EMC Richtlijn 2004/108/CE

Tip: vergeet uw mogelijke optionele toebehoren niet bij te bestellen:

- Geharde walsen voor inox.
- Gemotoriseerd toe zetten van de achterste rol.
- Digitale weergave van de toezet wals.
- Verlengde walsen met profielwalsen

Order nr.	713813314 ^M	713813315 ^M	713813316 ^M	713813317 ^M	713813318 ^M	713813319 ^M
Orig. nr.	RBM1550-60E PRO	RBM2050-50E PRO	RBM2050-60E PRO	RBM2550-40E PRO	RBM2550-60E PRO	RBM3050-60E PRO
Werkbreedte	mm 1550	2050	2050	2550	2550	3050
Diameter rollen	mm 130	150	170	150	190	220
Plaatdikte	mm 6	5	6	4	6	6
Minimum roldiameter	mm 195	225	255	225	285	330
Vermogen motor	kW 2.2	3	4	3	4	5.5
Spanning	V 3x400	3x400	3x400	3x400	3x400	3x400
Gewicht	kg 1400,00	1885,00	2100,00	2150,00	3400,00	6000,00
Afmetingen (l x b x h)	mm 3020 x 720 x 1300	3750 x 680 x 1040	3850 x 720 x 1050	4250 x 650 x 1020	4700 x 950 x 1300	5200 x 1150 x 1400



MADE IN EUROPE

MANUEEL
TOT 6 MM

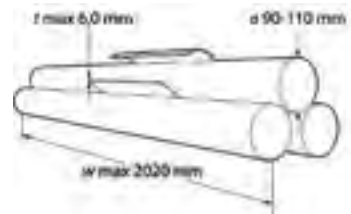

Krachtige, manuele plaatrolmachine met symmetrische rollen, en vaste onderrol.

Troeven:

- Grote plaatdiktes, maar nog steeds manueel
- Wegdraaibare bovenrol voor het gemakkelijk uitnemen van het werkstuk.
- Instelbare positie van bovenrol, ook voor conisch rollen.
- Gietijzeren machine op zware voet.
- Krachtige overbrengingshendel over gearde tandwielen
- Europese makelij

Geschikt voor:

- Eenvoudig toestel voor het zwaardere werk.

Tip: gearde rollen en toebehoren voor conisch buigen op aanvraag.

Order nr.	Orig. nr.	Werk Lengte	Diameter rollen	Maximum plaatdikte (400N/mm ²)	Gewicht	Prijs
		mm	mm	mm	kg	€
800210029	82631035	1020	90	3,5	295,00	4.249,00
800210031	82631050	1020	100	5,0	410,00	4.829,00
800210033	82631060	1020	110	6,0	460,00	5.120,00
800210035	82631230	1270	90	3,0	330,00	4.279,00
800210037	82631240	1270	100	4,0	460,00	4.919,00
800210039	82631250	1270	110	5,0	510,00	5.170,00
800210041	82635125	1525	90	2,5	355,00	4.519,00
800210043	82631535	1525	100	3,5	490,00	5.150,00
800210045	82631540	1525	110	4,0	560,00	5.370,00
800210053	82632010	2020	90	1,0	435,00	4.715,00
800210055	82632015	2020	100	1,5	570,00	5.430,00
800210057	82632020	2020	110	2,0	660,00	5.710,00



- Plaatdiktes tot 8mm
- 6 m/min
- Aparte noodstop
- Beveiligingsperimeter

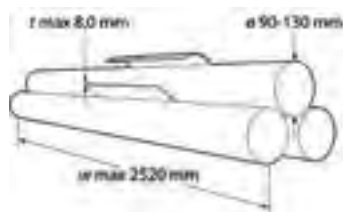

Gemotoriseerde plaatrolmachine met 2 symmetrische rollen, en vaste onderrol.

Troeven

- Wegdraaibare bovenrol voor het gemakkelijk uitnemen van het werkstuk.
- Instelbare positie van bovenrol, ook voor conisch rollen.
- Snelheid 6m/min.
- Voetschakelaar
- Gietijzeren machine op zware voet.
- Europese makelij.

Geschikt voor:

- ketelbouw, betere werkplaats, algemene industrie, scholen en opleidingscentra

Veiligheden:

- Beveiligingsperimeter met noodstopfunctie
- 400V 3-fasige motor met rem
- Veiligheidsklasse IP54
- Vergrendelbare hoofdschakelaar
- Nederlandstalige handleiding , opschriften , CE-kenmerk , en CE attest volgens Machine richtlijn 2006/42/CE, Laagspanningsrichtlijn 2006/95/CE en EMC Richtlijn 2004/108/CE

Tip: Geharde rollen en toebehoren voor conisch buigen op aanvraag.

Order nr.	Orig. nr.	Vermogen motor	Werklengte	Diameter rollen	Maximum plaatdikte (400N/mm ²)	
		kW	mm	mm	mm	mm
800210060 <small>M</small>	82641035	0,75	1020	90		3,5
800210062 <small>M</small>	82641050	1,1	1020	100		5,0
800210064 <small>M</small>	82641060	1,1	1020	110		6,0
800210066 <small>M</small>	82641070	1,5	1020	120		7,0
800210068 <small>M</small>	82641080	1,5	1020	130		8,0
800210070 <small>M</small>	82641230	0,75	1270	90		3,0
800210072 <small>M</small>	82641240	1,1	1270	100		4,0
800210074 <small>M</small>	82641250	1,1	1270	110		5,0
800210076 <small>M</small>	82641260	1,5	1270	120		6,0
800210078 <small>M</small>	82641270	1,5	1270	130		7,0
800210080 <small>M</small>	82641525	0,75	1525	90		2,5
800210082 <small>M</small>	82641535	1,1	1525	100		3,5
800210084 <small>M</small>	82641540	1,1	1525	110		4,0
800210086 <small>M</small>	82641550	1,5	1525	120		5,0
800210088 <small>M</small>	82641560	1,5	1525	130		6,0
800210100 <small>M</small>	82642010	0,75	2020	90		1,0
800210102 <small>M</small>	82642015	1,1	2020	100		1,5
800210104 <small>M</small>	82642020	1,1	2020	110		2,0
800210106 <small>M</small>	82642030	1,5	2020	120		3,0
800210108 <small>M</small>	82642040	1,5	2020	130		4,0
800210110 <small>M</small>	82642510	1,1	2520	110		1,0
800210112 <small>M</small>	82642515	1,5	2520	120		1,5
800210114 <small>M</small>	82642520	1,5	2520	130		2,0

Uithoekscharen



Manuele uithoeker **met 3 mm snijcapaciteit** in staal.

Troeven:

- Zware gietijzeren constructie voor het snel uitknippen van hoeken in metalen en andere materialen.
- Vaste snijhoek 90°.
- Roestvrijstaal 2 mm.
- Lange, krachtige overbrengingshendel
- Slag 30 mm
- Met gradenverdeling en instelbare aanslagen.

Geschikt voor:

- betere werkplaats, scholen en opleidingcentra.

Order nr.	713770512	
Orig. nr.	AKM100T	
Snijcapaciteit	mm	3
Snijbereik	mm	100x100
Snijhoek	°	90
Werktafel	mm	380x280
Gewicht	kg	105,00
Afmetingen (l x b x h)	mm	450 x 390 x 1020
Prijs	€	799,00



Manuele pijpuitklinker.

Troeven:

- Tot drie verschillende afmetingen (MRA2)
- Zowel horizontale als verticale montage
- Minder kracht vereist door krachtige overbrengingshendel
- Zeer eenvoudig te bedienen

Geschikt voor:

- lasvoorbereidingen van buizen, produceren van trapleuningen, etc.
- het uitklinken van buizen tot 3 mm wanddikte

Order nr.	713772992	713772993	
Orig. nr.	MRA2	MRA3	
Voor buisdiameter	mm	28 - 34 - 43	50 - 61
Wanddikte	mm	2	3
Prijs	€	295,00	389,00

Ponsknipmachines



Ponsmachine voor manueel ponsen.

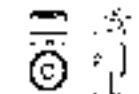

Matrijzen en ponsen

Troeven:

- Robuust gebouwd
- Grote uitlading
- Aandrijving van het mechanisme gebeurt met een tand-aandrijving
- Met verstelbare stop

Geschikt om:

- Vlug en eenvoudig manueel ponsen van stalen (400N/mm²) platen van 2,8 tot 10 mm voor de werkplaats.

Diameters en plaatdiktes:

- ø 13 - 10 mm
- ø 22 - 5.8 mm
- ø 45 - 2.8 mm (enkel mogelijk met andere matrijshouder, optioneel op aanvraag)

Geleverd met:

- Krachtige overbrengingshendel.
- 1 set ronde pons + matrijs ø 16 mm.

Diverse ponsen- en matrijzensets optioneel leverbaar:

Ronde ponsen / matrijzen van 4 tot 22mm

Vierkante ponsen / matrijzen van 8x8 tot 15x15 mm

Ovale ponsen / matrijzen van 6x14 tot 12x20 mm.

Order nr.	731051001	
Orig. nr.	BIR5BH10	
Capaciteit ponsen 12mm	mm	10
Capaciteit ponsen 16mm	mm	7
Capaciteit ponsen 18mm	mm	5
Capaciteit ponsen 20mm	mm	4
Uitlading	mm	150
Gewicht	kg	65,00
Prijs	€	565,00



Set pons en matrijs per diameter voor ponsenheid BIR5BH10.

Order nr.	Orig. nr.	Capaciteit mm	Prijs €
731051064	BIR5BH10-4MM	4	29,50
731051066	BIR5BH10-6MM	6	29,50
731051068	BIR5BH10-8MM	8	29,50
731051070	BIR5BH10-10MM	10	29,50
731051072	BIR5BH10-12MM	12	29,50
731051074	BIR5BH10-14MM	14	29,50
731051076	BIR5BH10-16MM	16	29,50
731051078	BIR5BH10-18MM	18	29,50
731051080	BIR5BH10-20MM	20	29,50
731051082	BIR5BH10-22MM	22	29,50



Industriële, hydraulische ponsknipmachine met 4 werkstations.

Troeven:

- Zware en stabiele gelasteconstructie
- Met krachtige motor
- Werkt met Mubea opname
- Met 4 werkstations: ponsen, knippen: rond, vierkant, hoekprofiel knippen, plaatstaal knippen
- Tijdsbesparende cyclustijden, geen spanen en geen koeling tov boren

Geschied voor:

- Algemene industrie, onderhoud, kortom onmisbaar in iedere werkplaats

Kenmerken:

- Geslepen oplegtafel ponskant met werkstukaanslag
- Hoogwaardige hydraulische cilinder en groep

Veiligheden:

- Aparte noodstop op de machine
- Voetpedaalbediening met aparte noodstop
- Nullastspanning
- Veiligheidsafschermingen op alle stations
- Vergenelbare hoofdschakelaar

Order nr.	713819040	
Algemeen		
Orig. nr.		HPS 40S
Capaciteit	t	40
Uitlading	mm	175
Slag	mm	50
Vermogen motor	kW	3
Spanning	V	3x400
Uitlading	mm	175
Slag	mm	50
Ponsen		
Maximum capaciteit	mm	20x15 / 30x10
Werkhoogte ponsen	mm	970
Knippen		
Maximum breedte	mm	200x13 / 300x6
Meslengte	mm	356
Maximum rond	mm	30
Maximum vierkant	mm	25
Werkhoogte knippen	mm	980
Hoekprofiel knippen		
Max. afmetingen 90°	mm	80x80x8
Max. afmetingen 45°	mm	50x6
Max. afmetingen 90°	mm	80x80x8
Max. afmetingen 45°	mm	50x6
Werkhoogte hoekprofiel knippen	mm	1100
Rechthoekig uithoeken		
Maximum plaatdikte	mm	-
Breedte	mm	-
Diepte	mm	-
Optionele stations		
U/I Profiel	mm	76x38
T-Profiel	mm	38x6
V uithoeken	mm	-
Gewicht	kg	580,00
Afmetingen (l x b x h)	mm	1100 x 800 x 1520

HPS40S

4 STATIONS

3KW



MACHINES



Hoekprofiel knippen



Rondstaal knippen



Ponsen



Plaatstaal knippen

Geleverd met:

- Bedieningsleutels
- Haaksleutel
- Pons en matrijsreducties
- Nederlandstalige handleiding, opschriften, CE - kenmerk, en CE-attest volgens Machine richtlijn 2006/42/CE, Laagspanningsrichtlijn 2006/95/CE en EMC Richtlijn 2004/108/CE



Industriële, hydraulische ponsknipmachine met 5 werkstations.

Troeven:

- Zware en stabiele gelasteconstructie
- Met krachtige motor
- Werkt met Mubea opname
- Met 5 werkstations: ponsen, knippen: rond, vierkant, hoekprofiel knippen, plaatstaal knippen, rechthoekig uithoeken
- Tijdsbesparende cyclustijden, geen spanen en geen koeling tov boren

Geslacht voor:

- Algemene industrie, onderhoud, kortom onmisbaar in iedere werkplaats

Kenmerken:

- Geslepen oplegtafel ponskant met werkstukaanslag
- Geslepen oplegtafel uithoekstation met werkstukaanslag
- Hoogwaardige hydraulische cilinder en groep

Veiligheden:

- Aparte noodstop op de machine
- Voetpedaalbediening met aparte noodstop
- Nullastspanning
- Veiligheidsafschermingen op alle stations
- Vergenelbare hoofdschakelaar

Order nr.

713819045 M

Algemeen

Orig. nr.		HPS 45S
Capaciteit	t	45
Uitlading	mm	175
Slag	mm	50
Vermogen motor	kW	4
Spanning	V	3x400
Uitlading	mm	175
Slag	mm	50

Ponsen

Maximum capaciteit	mm	22x15 / 38x8
Werkhoogte ponsen	mm	935

Knippen

Maximum breedte	mm	200x15 / 300x12
Meslengte	mm	316
Maximum rond	mm	30
Maximum vierkant	mm	25
Werkhoogte knippen	mm	935

Hoekprofiel knippen

Max. afmetingen 90°	mm	100x100x10
Max. afmetingen 45°	mm	70x6
Max. afmetingen 90°	mm	100x100x10
Max. afmetingen 45°	mm	70x6
Werkhoogte hoekprofiel knippen	mm	1140

Rechthoekig uithoeken

Maximum plaatdikte	mm	8
Breedte	mm	35
Diepte	mm	75

Optionele stations

U/I Profiel	mm	80x45
T-Profiel	mm	40x5
V uithoeken	mm	100x100x10
Gewicht	kg	1165,00
Afmetingen (l x b x h)	mm	1430 x 950 x 1780

HPS45S



MACHINES



Hoekprofiel knippen



Ponsen



Plaatstaal knippen



Uithoeken



Rondstaal knippen

Geleverd met:

- Bedieningsleutels
- Haaksleutel
- Pons en matrijsreducties
- Nederlandstalige handleiding, opschriften, CE - kenmerk, en CE-attest volgens Machine richtlijn 2006/42/CE, Laagspanningsrichtlijn 2006/95/CE en EMC Richtlijn 2004/108/CE



Industriële, hydraulische ponsknipmachine met 5 werkstations.

Troeven:

- Zware en stabiele gelasteconstructie
- Met krachtige motor
- Werkt met Mubea opname
- Met 5 werkstations: ponsen, knippen: rond, vierkant, hoekprofiel knippen, plaatstaal knippen, rechthoekig uithoeken
- Tijdsbesparende cyclustijden, geen spanen en geen koeling tov boren

Geschikt voor:

- Algemene industrie, onderhoud, kortom onmisbaar in iedere werkplaats

Kenmerken:

- Geslepen oplegtafel ponskant met werkstukaanslag
- Geslepen oplegtafel uithoekstation met werkstukaanslag
- Hoogwaardige hydraulische cilinder en groep

Veiligheden:

- Aparte noodstop op de machine
- Voetpedaalbediening met aparte noodstop
- Nullastspanning
- Veiligheidsafschermingen op alle stations
- Vergenelbare hoofdschakelaar

Order nr.	713819060	
Algemeen		
Orig. nr.		HPS 60S
Capaciteit	t	60
Uitlading	mm	220
Slag	mm	55
Vermogen motor	kW	4
Spanning	V	3x400
Uitlading	mm	220
Slag	mm	55
Ponsen		
Maximum capaciteit	mm	28x15 / 38x11
Werkhoogte ponsen	mm	955
Knippen		
Maximum breedte	mm	200x20 / 300x15
Meslengte	mm	317
Maximum rond	mm	40
Maximum vierkant	mm	35
Werkhoogte knippen	mm	1155
Hoekprofiel knippen		
Max. afmetingen 90°	mm	120x120x12
Max. afmetingen 45°	mm	80x8
Max. afmetingen 90°	mm	120x120x12
Max. afmetingen 45°	mm	80x8
Werkhoogte hoekprofiel knippen	mm	1155
Rechthoekig uithoeken		
Maximum plaatdikte	mm	10
Breedte	mm	42
Diepte	mm	100
Optionele stations		
U/I Profiel	mm	80x45
T-Profiel	mm	80x9
V uithoeken	mm	100xx100x10
Gewicht	kg	1440,00
Afmetingen (l x b x h)	mm	1520 x 950 x 1780

4KW



Hoekprofiel knippen



Ponsknippen



Plaatstaal knippen



Uithoeken



Rondstaal knippen

Geleverd met:

- Bedieningsleutels
- Haaksleutel
- Pons en matrijsreducties
- Nederlandstalige handleiding, opschriften, CE - kenmerk, en CE-attest volgens Machine richtlijn 2006/42/CE, Laagspanningsrichtlijn 2006/95/CE en EMC Richtlijn 2004/108/CE



Industriële, hydraulische ponsknipmachine met 5 werkstations en dubbele bediening

Troeven:

- Dubbele voetpedaalbediening, mogelijk om pons en knipstation gelijktijdig te bedienen
- Zware en stabiele gelasteconstructie
- Met krachtige motor
- Werkt met Mubea opname
- Met 5 werkstations: ponsen, knippen: rond, vierkant, hoekprofiel knippen, plaatstaal knippen, rechthoekig uithoeken
- Tijdsbesparende cyclustijden, geen spanen en geen koeling tov boren
- Elektrische materiaal aanslag
- Machineverlichting met magneetvoet

Geschied voor:

- Algemene industrie, onderhoud, kortom onmisbaar in iedere werkplaats

Kenmerken:

- Geslepen oplegtafel ponskant met werkstukaanslag
- Geslepen oplegtafel uithoekstation met werkstukaanslag
- 2 hoogwaardige hydraulische werkcilinders en groep

Veiligheden:

- Aparte noodstop op de machine
- 2 voetpedaalbedieningen met aparte noodstop
- Nullastspanning
- Veiligheidsafschermingen op alle stations
- Vergenelbare hoofdschakelaar

Order nr.

713819055 M

Algemeen

Orig. nr.		HPS 55 DS
Capaciteit	t	55
Uitlading	mm	255
Slag	mm	60
Vermogen motor	kW	5,5
Spanning	V	3x400
Uitlading	mm	255
Slag	mm	60

Ponsen

Maximum capaciteit	mm	20x20 / 40x10
Werkhoogte ponsen	mm	1030

Knippen

Maximum breedte	mm	200x20 / 300x15
Meslengte	mm	317
Maximum rond	mm	40
Maximum vierkant	mm	40
Werkhoogte knippen	mm	900

Hoekprofiel knippen

Max. afmetingen 90°	mm	120x120x12
Max. afmetingen 45°	mm	70x10
Max. afmetingen 90°	mm	120x120x12
Max. afmetingen 45°	mm	70x10
Werkhoogte hoekprofiel knippen	mm	1130

Rechthoekig uithoeken

Maximum plaatdikte	mm	10
Breedte	mm	45
Diepte	mm	90

Optionele stations

U/I Profiel	mm	120x58
T-Profiel	mm	80x9
V uithoeken	mm	100x100x10
Gewicht	kg	1520,00
Afmetingen (l x b x h)	mm	1500 x 950 x 1880



OVALE, VIERKANTE PONS EN MATRIJZEN
p. 849 à 852

HPS55DS

3 STATIONS

5,5KW

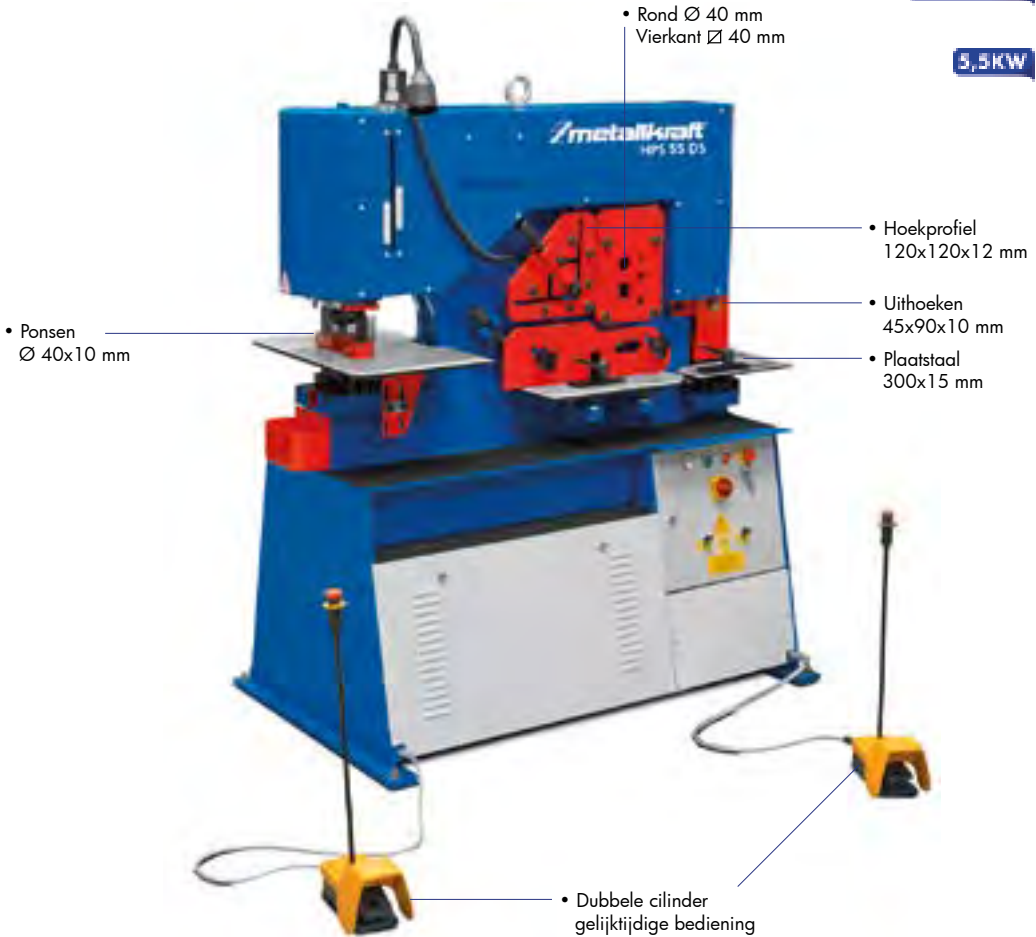

MACHINES



Elektrische materiaal aanslag



Verlichting



ANDERE MODELLEN LEVERBAAR
TOT 175 TON

Geleverd met:

- Bedieningsleutels
- Haaksleutel
- Pons en matrijsreducties
- Nederlandstalige handleiding, opschriften, CE - kenmerk, en CE-attest volgens Machine richtlijn 2006/42/CE, Laagspanningsrichtlijn 2006/95/CE en EMC Richtlijn 2004/108/CE

PONSEN EN MATRIJZEN

De afmetingen van het gat dat u wenst te ponsen wordt bepaald door de pons afmetingen. De ponsen worden aangeduid met deze afmeting.

De matrijsopening moet wijder zijn dan de speling (= tweemaal de snij opening). Volgens onze ervaring bedraagt de speling ongeveer 10% van de materiaaldikte.

De matrijs aanduiding toont de actuele afmetingen van de snij opening (opening van de matrijs).

Grondregels:

1. Wanneer u de speling bepaalt, raden wij u aan de volgende regels te volgen:

Voor ronde ponsen:

Materiaaldikte tot 4mm, spelling 0,2mm

Materiaaldikte tot > 4-9mm, spelling 0,7mm

Materiaaldikte tot > 9-14mm, spelling 1,2mm

Materiaaldikte tot > 14-19mm, spelling 1,7mm

Materiaaldikte tot > 19-24mm, spelling 2,2mm

Bvb.:

- Ponsdiameter: 20,0 mm

- Materiaaldikte: 12,0 mm

- Matrijsopening: 21,2 mm

2. U kunt nooit met een kleinere ponsdiameter een dikkere plaat ponsen.

Bvb.:

- Ponsdiameter: 7 mm

- Materiaaldikte: 8 mm

is niet mogelijk.

3. Verzeker u ervan dat de speling altijd in lijn staat tussen pons en matrijs opening.

4. De matrijs, ponshouder en reducties dienen veilig bevestigd te worden in hun supports.

5. De afstrijker of neerhouder moeten in overeenstemming handelen en worden uitgelijnd met de oppervlakte van de matrijs

6. Om de hoogst mogelijke levensduur van uw pons te bekomen, dient u de ponsen frequent te smeren, tijdens het ponsen.

7. Om uw ponsknipmachine niet te overbelasten, raden wij u aan rekening te houden met de max. ponscapaciteit aangegeven op de prestatieplaat.

Diameter x materiaaldikte x materiaal trekstrekte
(tot 600 N/mm², kunt u de factor 0,8 gebruiken)





Mubea

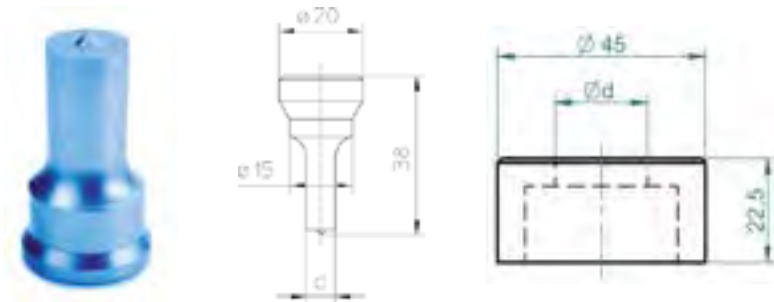

Mubea ronde ponsen en matrijzen Gr.1.

Deze ronde ponsen Gr. 1 kunnen enkel ingezet worden door gebruik te maken van de ponsreductie inzet 790504020 en de ponsreductie 790504022.

De ronde matrijzen Gr.1 enkel door gebruik te maken van de matrijsreducties 790504032 en 790504034.

Order nr.	Orig. nr.	Omschrijving	Diameter mm	Mubea nr	Gewicht kg	Afmetingen (l x b x h) mm	Prijs €
790400002	MBP1-3,0	pons	3,0	50505 11 008	0,25	20 x 20 x 38	6,90
790400004	MBP1-3,5	pons	3,5	50505 11 011	0,25	20 x 20 x 38	6,90
790400006	MBP1-4,0	pons	4,0	50505 11 013	0,25	20 x 20 x 38	6,90
790400008	MBP1-4,5	pons	4,5	50505 11 015	0,25	20 x 20 x 38	6,90
790400010	MBP1-5,0	pons	5,0	50505 11 017	0,25	20 x 20 x 38	6,90
790400012	MBP1-5,5	pons	5,5	50505 11 019	0,25	20 x 20 x 38	6,90
790400014	MBP1-6,0	pons	6,0	50505 11 022	0,25	20 x 20 x 38	6,90
790400016	MBP1-6,5	pons	6,5	50505 11 024	0,25	20 x 20 x 38	6,90
790400018	MBP1-7,0	pons	7,0	50505 11 026	0,25	20 x 20 x 38	6,90
790400020	MBP1-7,5	pons	7,5	50505 11 028	0,25	20 x 20 x 38	6,90
790400022	MBP1-8,0	pons	8,0	50505 11 031	0,25	20 x 20 x 38	6,90
790400024	MBP1-8,5	pons	8,5	50505 11 033	0,25	20 x 20 x 38	6,90
790400026	MBP1-9,0	pons	9,0	50505 11 035	0,25	20 x 20 x 38	6,90
790400028	MBP1-9,5	pons	9,5	50505 11 037	0,25	20 x 20 x 38	6,90
790400030	MBP1-10,0	pons	10,0	50505 11 039	0,25	20 x 20 x 38	6,90
790400032	MBP1-10,5	pons	10,5	50505 11 042	0,25	20 x 20 x 38	6,90
790400034	MBP1-11,0	pons	11,0	50505 11 044	0,25	20 x 20 x 38	6,90
790400036	MBP1-11,5	pons	11,5	50505 11 046	0,25	20 x 20 x 38	6,90
790400038	MBP1-12,0	pons	12,0	50505 11 048	0,25	20 x 20 x 38	6,90
790400040	MBP1-12,5	pons	12,5	50505 11 051	0,25	20 x 20 x 38	6,90
790400042	MBP1-13,0	pons	13,0	50505 11 053	0,25	20 x 20 x 38	6,90
790400044	MBP1-13,5	pons	13,5	50505 11 055	0,25	20 x 20 x 38	6,90
790400046	MBP1-14,0	pons	14,0	50505 11 057	0,25	20 x 20 x 38	6,90
790400048	MBP1-14,5	pons	14,5	50505 11 059	0,25	20 x 20 x 38	6,90
790400050	MBP1-15,0	pons	15,0	50505 11 062	0,25	20 x 20 x 38	6,90



Mubea

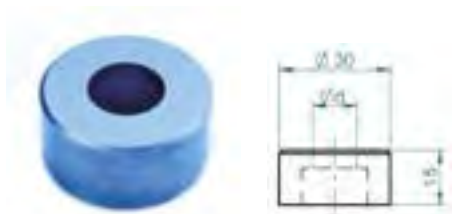

De ronde matrijzen Gr.1 enkel door gebruik te maken van de matrijsreducties 790504032 en 790504034.

Order nr.	Orig. nr.	Omschrijving	Diameter mm	Mubea nr	Gewicht kg	Afmetingen (l x b x h) mm	Prijs €
790500002	MBM1-3,2	matrijs	3,2	50633 01 009	0,25	30 x 30 x 15	6,70
790500004	MBM1-3,7	matrijs	3,7	50633 01 012	0,25	30 x 30 x 15	6,70
790500006	MBM1-4,2	matrijs	4,2	50633 01 014	0,25	30 x 30 x 15	6,70
790500008	MBM1-4,7	matrijs	4,7	50633 01 016	0,25	30 x 30 x 15	6,70
790500010	MBM1-5,2	matrijs	5,2	50633 01 018	0,25	30 x 30 x 15	6,70
790500012	MBM1-5,7	matrijs	5,7	50633 01 021	0,25	30 x 30 x 15	6,70
790500014	MBM1-6,2	matrijs	6,2	50633 01 023	0,25	30 x 30 x 15	6,70
790500016	MBM1-6,7	matrijs	6,7	50633 01 025	0,25	30 x 30 x 15	6,70
790500018	MBM1-7,2	matrijs	7,2	50633 01 027	0,25	30 x 30 x 15	6,70
790500020	MBM1-7,7	matrijs	7,7	50633 01 029	0,25	30 x 30 x 15	6,70
790500022	MBM1-8,2	matrijs	8,2	50633 01 032	0,25	30 x 30 x 15	6,70
790500024	MBM1-8,7	matrijs	8,7	50633 01 034	0,25	30 x 30 x 15	6,70
790500026	MBM1-9,2	matrijs	9,2	50633 01 036	0,25	30 x 30 x 15	6,70
790500028	MBM1-9,7	matrijs	9,7	50633 01 038	0,25	30 x 30 x 15	6,70
790500030	MBM1-10,2	matrijs	10,2	50633 01 041	0,25	30 x 30 x 15	6,70
790500032	MBM1-10,7	matrijs	10,7	50633 01 043	0,25	30 x 30 x 15	6,70
790500034	MBM1-11,2	matrijs	11,2	50633 01 045	0,25	30 x 30 x 15	6,70
790500036	MBM1-11,7	matrijs	11,7	50633 01 047	0,25	30 x 30 x 15	6,70
790500038	MBM1-12,2	matrijs	12,2	50633 01 049	0,25	30 x 30 x 15	6,70
790500040	MBM1-12,7	matrijs	12,7	50633 01 052	0,25	30 x 30 x 15	6,70
790500042	MBM1-13,2	matrijs	13,2	50633 01 054	0,25	30 x 30 x 15	6,70
790500044	MBM1-13,7	matrijs	13,7	50633 01 056	0,25	30 x 30 x 15	6,70
790500046	MBM1-14,2	matrijs	14,2	50633 01 058	0,25	30 x 30 x 15	6,70
790500048	MBM1-14,7	matrijs	14,7	50633 01 061	0,25	30 x 30 x 15	6,70
790500050	MBM1-15,2	matrijs	15,2	50633 01 063	0,25	30 x 30 x 15	6,70
790500052	MBM1-15,7	matrijs	15,7	50633 01 065	0,25	30 x 30 x 15	6,70
790500054	MBM1-16,2	matrijs	16,2	50633 01 067	0,25	30 x 30 x 15	6,70



Mubea

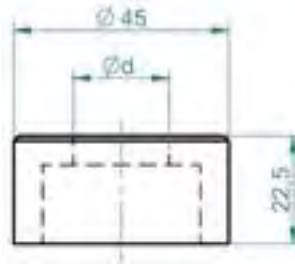
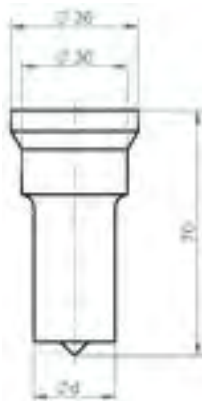

Mubea ronde ponsen en matrijzen Gr.2.

Deze ronde ponsen Gr. 2 kunnen enkel ingezet worden door gebruik te maken van de ponsreductie 790504026.
De ronde matrijzen Gr.2 enkel door gebruik te maken van de matrijsreducties 790504036.

Order nr.	Orig. nr.	Omschrijving	Diameter mm	Mubea nr	Gewicht kg	Afmetingen (l x b x h) mm	Prijs €
790400052	MBP2-15,5	pons	15,5	50505 21 064	0,35	36 x 36 x 70	9,60
790400054	MBP2-16,0	pons	16,0	50505 21 066	0,35	36 x 36 x 70	9,60
790400056	MBP2-16,5	pons	16,5	50505 21 068	0,35	36 x 36 x 70	9,60
790400058	MBP2-17,0	pons	17,0	50505 21 071	0,35	36 x 36 x 70	9,60
790400060	MBP2-17,5	pons	17,5	50505 21 073	0,35	36 x 36 x 70	9,60
790400062	MBP2-18,0	pons	18,0	50505 21 075	0,35	36 x 36 x 70	9,60
790400064	MBP2-18,5	pons	18,5	50505 21 077	0,35	36 x 36 x 70	9,60
790400066	MBP2-19,0	pons	19,0	50505 21 079	0,35	36 x 36 x 70	9,60
790400068	MBP2-19,5	pons	19,5	50505 21 082	0,35	36 x 36 x 70	9,60
790400070	MBP2-20,0	pons	20,0	50505 21 084	0,35	36 x 36 x 70	9,60
790400072	MBP2-20,5	pons	20,5	50505 21 086	0,35	36 x 36 x 70	9,60
790400074	MBP2-21,0	pons	21,0	50505 21 088	0,35	36 x 36 x 70	9,60
790400076	MBP2-21,5	pons	21,5	50505 21 091	0,35	36 x 36 x 70	9,60
790400078	MBP2-22,0	pons	22,0	50505 21 093	0,35	36 x 36 x 70	9,60
790400080	MBP2-22,5	pons	22,5	50505 21 095	0,35	36 x 36 x 70	9,60
790400082	MBP2-23,0	pons	23,0	50505 21 097	0,35	36 x 36 x 70	9,60
790400084	MBP2-23,5	pons	23,5	50505 21 099	0,35	36 x 36 x 70	9,60
790400086	MBP2-24,0	pons	24,0	50505 21 102	0,35	36 x 36 x 70	9,60
790400088	MBP2-24,5	pons	24,5	50505 21 104	0,35	36 x 36 x 70	9,60
790400090	MBP2-25,0	pons	25,0	50505 21 106	0,35	36 x 36 x 70	9,60
790400092	MBP2-25,5	pons	25,5	50505 21 108	0,35	36 x 36 x 70	9,60
790400094	MBP2-26,0	pons	26,0	50505 21 111	0,35	36 x 36 x 70	9,60
790400096	MBP2-26,5	pons	26,5	50505 21 113	0,35	36 x 36 x 70	9,60
790400098	MBP2-27,0	pons	27,0	50505 21 115	0,35	36 x 36 x 70	9,60
790400100	MBP2-27,5	pons	27,5	50505 21 117	0,35	36 x 36 x 70	9,60
790400102	MBP2-28,0	pons	28,0	50505 21 119	0,35	36 x 36 x 70	9,60
790400104	MBP2-28,5	pons	28,5	50505 21 122	0,35	36 x 36 x 70	9,60
790400106	MBP2-29,0	pons	29,0	50505 21 124	0,35	36 x 36 x 70	9,60
790400108	MBP2-29,5	pons	29,5	50505 21 126	0,35	36 x 36 x 70	9,60
790400110	MBP2-30,0	pons	30,0	50505 21 128	0,35	36 x 36 x 70	9,60



Mubea

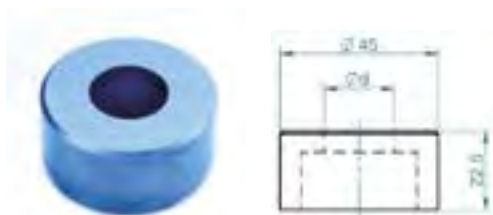

Mubea ronde matrijzen Gr.2.

De ronde matrijzen Gr.2 enkel door gebruik te maken van de matrijsreducties 790504036.

Order nr.	Orig. nr.	Omschrijving	Diameter mm	Mubea nr	Gewicht kg	Afmetingen (l x b x h) mm	Prijs €
790500056	MBM2-15,7	matrijs	15,7	50638 01 065	0,35	45 x 45 x 225	11,10
790500058	MBM2-16,2	matrijs	16,2	50638 01 067	0,35	45 x 45 x 225	11,10
790500060	MBM2-16,7	matrijs	16,7	50638 01 069	0,35	45 x 45 x 225	11,10
790500062	MBM2-17,2	matrijs	17,2	50638 01 072	0,35	45 x 45 x 225	11,10
790500064	MBM2-17,7	matrijs	17,7	50638 01 074	0,35	45 x 45 x 225	11,10
790500066	MBM2-18,2	matrijs	18,2	50638 01 076	0,35	45 x 45 x 225	11,10
790500068	MBM2-18,7	matrijs	18,7	50638 01 078	0,35	45 x 45 x 225	11,10
790500070	MBM2-19,2	matrijs	19,2	50638 01 081	0,35	45 x 45 x 225	11,10
790500072	MBM2-19,7	matrijs	19,7	50638 01 083	0,35	45 x 45 x 225	11,10
790500074	MBM2-20,2	matrijs	20,2	50638 01 085	0,35	45 x 45 x 225	11,10
790500076	MBM2-20,7	matrijs	20,7	50638 01 087	0,35	45 x 45 x 225	11,10
790500078	MBM2-21,2	matrijs	21,2	50638 01 089	0,35	45 x 45 x 225	11,10
790500080	MBM2-21,7	matrijs	21,7	50638 01 092	0,35	45 x 45 x 225	11,10
790500082	MBM2-22,2	matrijs	22,2	50638 01 094	0,35	45 x 45 x 225	11,10
790500084	MBM2-22,7	matrijs	22,7	50638 01 096	0,35	45 x 45 x 225	11,10
790500086	MBM2-23,2	matrijs	23,2	50638 01 098	0,35	45 x 45 x 225	11,10
790500088	MBM2-23,7	matrijs	23,7	50638 01 101	0,35	45 x 45 x 225	11,10
790500090	MBM2-24,2	matrijs	24,2	50638 01 103	0,35	45 x 45 x 225	11,10
790500092	MBM2-24,7	matrijs	24,7	50638 01 105	0,35	45 x 45 x 225	11,10
790500094	MBM2-25,2	matrijs	25,2	50638 01 107	0,35	45 x 45 x 225	11,10
790500096	MBM2-25,7	matrijs	25,7	50638 01 109	0,35	45 x 45 x 225	11,10
790500098	MBM2-26,2	matrijs	26,2	50638 01 112	0,35	45 x 45 x 225	11,10
790500100	MBM2-26,7	matrijs	26,7	50638 01 114	0,35	45 x 45 x 225	11,10
790500102	MBM2-27,2	matrijs	27,2	50638 01 116	0,35	45 x 45 x 225	11,10
790500104	MBM2-27,7	matrijs	27,7	50638 01 118	0,35	45 x 45 x 225	11,10
790500106	MBM2-28,2	matrijs	28,2	50638 01 121	0,35	45 x 45 x 225	11,10
790500108	MBM2-28,7	matrijs	28,7	50638 01 123	0,35	45 x 45 x 225	11,10
790500110	MBM2-29,2	matrijs	29,2	50638 01 125	0,35	45 x 45 x 225	11,10
790500112	MBM2-29,7	matrijs	29,7	50638 01 127	0,35	45 x 45 x 225	11,10
790500114	MBM2-30,2	matrijs	30,2	50638 01 129	0,35	45 x 45 x 225	11,10
790500116	MBM2-30,7	matrijs	30,7	50638 01 132	0,35	45 x 45 x 225	11,10
790500118	MBM2-31,2	matrijs	31,2	50638 01 134	0,35	45 x 45 x 225	11,10
790500120	MBM2-31,7	matrijs	31,7	50638 01 136	0,35	45 x 45 x 225	11,10



Mubea

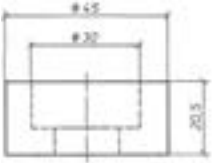

Mubea matrijsreductie MBN50606-1.

Order nr.	790504032
Orig. nr.	MBMR1
Buitendiameter	mm 45
Binnendiameter	mm 30
Gewicht	kg 0,20
Afmetingen (l x b x h)	mm 45 x 45 x 205
Prijs	€ 37,50

Mubea

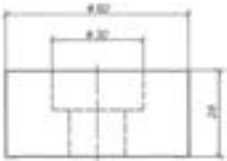

Mubea matrijsreductie MBN50606-2.

Order nr.	790504034
Orig. nr.	MBMR2
Buitendiameter	mm 60
Binnendiameter	mm 30
Gewicht	kg 0,30
Afmetingen (l x b x h)	mm 60 x 60 x 28
Prijs	€ 57,50

Mubea

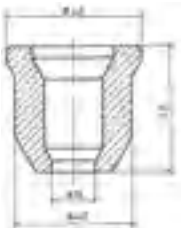

Mubea reductie MBN50531-4 voor ponsen MBN50505-1, MBP1, van \varnothing 3 tot 15 mm. Voor snelspansysteem Mubea en wartelmoer M52.

Order nr.	790504024
Orig. nr.	MBPR2
Gewicht	kg 0,20
Afmetingen (l x b x h)	mm 46 x 46 x 43
Prijs	€ 76,30

Mubea

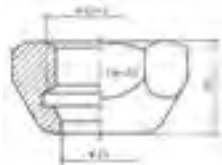

Wartelmoer M42 voor Mubea ponsen MBN50505-2, MBP2, MBVP2, MBOP2; voor ponsen met diameter \varnothing 36 mm, \varnothing 15,5 tot 30 mm.

Order nr.	790504002
Orig. nr.	MBWM4230
Schroefdraad	M 42x2
Diameter	mm 30
Gewicht	kg 0,55
Afmetingen (l x b x h)	mm 60 x 60 x 36
Prijs	€ 72,50

Mubea

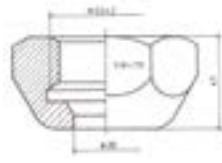

Wartelmoer M52 voor Mubea ponsen MBN50505-2, MBP2, MBVP2, MBOP2; voor ponsen met diameter \varnothing 36 mm, \varnothing 15,5 tot 30 mm.

Order nr.	790504004
Orig. nr.	MBWM5230
Schroefdraad	M 52x2
Diameter	mm 30
Gewicht	kg 0,65
Afmetingen (l x b x h)	mm 75 x 75 x 43
Prijs	€ 81,90

METAALBEWERKINGSMACHINES

Kwaliteit tegen een voordelige prijs: metaalbewerkingmachines van OPTIMUM®

Optimum ontwerpt en ontwikkelt al meer dan 15 jaar machines voor metaalbewerking. Optimum onderscheidt zich door kwaliteit, nauwkeurigheid, duurzaamheid en z'n consistentie. Naast de eigen productievestigingen worden onze machines ook samen met andere fabrikanten ontwikkeld; producenten die voldoen aan de hoge kwaliteitseisen. Alle opgedane kennis wordt gebruikt voor een voortdurende ontwikkeling en verbetering van de Optimum producten. Vanaf de ontwikkeling, tot de serieproductie en tot bij de dienst-na-verkoop houden we onze producten zorgvuldig in de gaten. Dit resulteert in een hoog kwaliteitsniveau.

De producten

Bent u op zoek naar een functionele machine met uitgebreide prestatiekenmerken voor de juiste prijs? Dan maakt u de juiste beslissing als u kiest voor een metaalbewerkingsmachine van Optimum. Onze machines overtuigen door uitstekende prijs/kwaliteit, nauwkeurigheid, precisie en prestatie. De Optimum kwaliteit garandeert dat alle Optimum producten geproduceerd worden met hoge kwaliteitseisen.

Mocht u onze dienst-na-verkoop nodig hebben, dan zullen wij tot uw beschikking staan met een ervaren after-sales team. Een uitgebreide voorraad van reserveonderdelen kan, indien nodig, op korte termijn geleverd worden. Onze service garandeert een standvastig gebruik van uw machine gedurende vele jaren.

Wij bieden:

- Tafelboormachines
- Radiaalboormachines
- Kolom-boorfreesmachines
- Freesmachines
- Draaibanken
- Digitale uitlezing
- Lintzaagmachines
- Cirkelzaagmachines
- Slijpmachines
- Polijstmachines
- Plaatbewerkingsmachines
- CNC machines
- Accessoires

OPTI turn®

OPTI saw®

OPTI mill®

OPTI grind®

OPTI drill®

OPTI chuck®



OPTIMUM
MASCHINEN - GERMANY

Slijpmachines



MACH



ME20

Slijpmolens voor de veeleisende gebruiker.

Troeven:

- Krachtige motor
- Afschermingen van de slijpstenen in plaatstaal
- Uitgebalanceerde as met hoge kwaliteitslagers
- Robuuste as met grote asdiameter van ø 32
- Zwaar lichaam verzekert een stabiel werken

Kenmerken:

- Onderhoudsvrije motor voor een continu gebruik
- Lichaam in gietaluminium
- Geluidsarme werking
- Start / stopknop met rode afdekknop
- Nullastspanning
- Iedere slijpmolen wordt afzonderlijk getest
- Geproduceerd volgens CE normen

Geleverd met:

- Twee slijpstenen, korrel 36 en korrel 60
- 2 stabiele en instelbare materiaalaanslagen
- 2 grote regelbare oogbeschermingsglazen

Order nr.		794001150	794001200
Orig. nr.		ME15	ME20 230V
Spanning	V	230	230
Slijpsteenafm. (Ø x b x Ø as)	mm	150x25x32	200x32x32
Toerental	min-1	2950	2950
Vermogen motor	W	520	900
Gewicht	kg	16,00	28,00
Afmetingen (l x b x h)	mm	471 x 261 x 254	526 x 320 x 310
Prijs	€	99,00	159,00

MACH

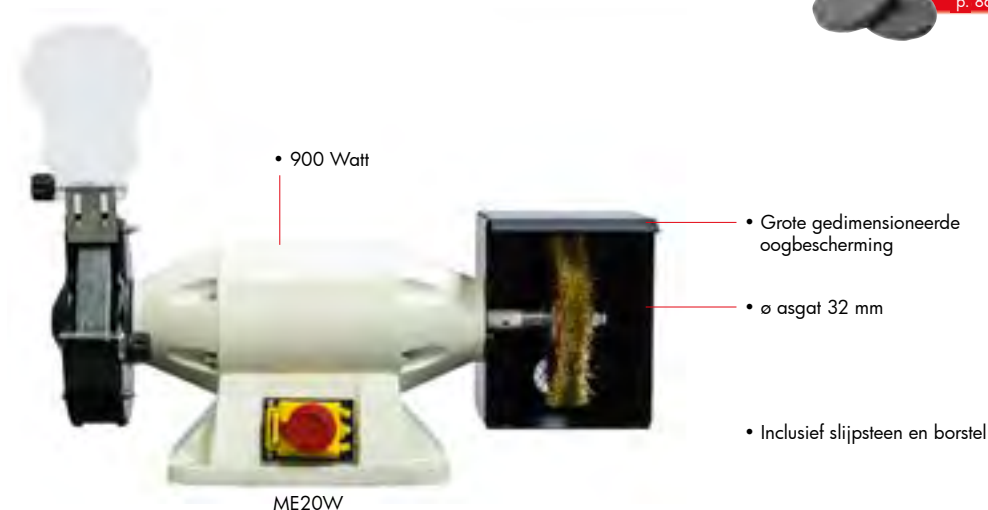
ACCESSOIRES
p. 863

Slijpmolens met borstel voor de veeleisende gebruiker.

Troeven:



- Krachtige motor
- Afschermingen van de slijpsteen in plaatstaal
- Groot gedimensioneerde afscherming voor de borstel
- Uitgebalanceerde as met hoge kwaliteitslagers
- Robuuste as lmet grote asdiameter van ø 32
- Zwaar lichaam verzekert een stabiel werken

Kenmerken:

- Onderhoudsvrije motor voor een continu gebruik
- Lichaam in gietaluminium
- Geluidsarme werking
- Start / stopknop met rode afdekknop
- Nullastspanning
- Iedere slijpmolen wordt afzonderlijk getest
- Geproduceerd volgens CE normen

Geleverd met:

- 1 slijpsteen, korrel 36
- 1 borstel
- 2 stabiele en instelbare materiaalaanslagen
- 2 grote regelbare oogbeschermingsglazen

Order nr.		794002150 	794002200 
Orig. nr.		ME15W 230V	ME20W 230V
Spanning	V	230	230
Slijpssteenafm. (Ø x b x Ø as)	mm	150x25x32	200x32x32
Toerental	min-1	2950	2950
Vermogen motor	W	520	900
Borstelafmetingen (diameter x b x asgat)	mm	150x25x32	200x25x32
Gewicht	kg	15,00	27,00
Afmetingen (l x b x h)	mm	550 x 261 x 254	896 x 320 x 310
Prijs	€	109,00	189,00

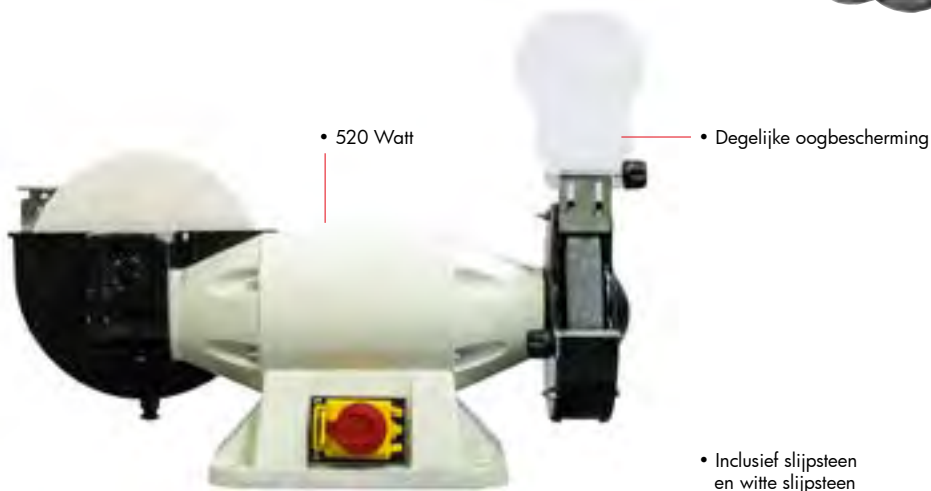

• Inclusief slijpsteen en witte slijpsteen

Natdrooglijper voor de veeleisende gebruiker.

Troeven:

- Om te slijpen
- Krachtige motor van 520W
- Afscherming van de slijpsteen in plaatstaal
- Eenvoudig te reinigen reservoir
- Uitgebalanceerde as met hoge kwaliteitslagers

Kenmerken:

- Onderhoudsvrije motor voor een continu gebruik
- Lichaam in gietaluminium
- Geluidsarme werking
- Start / stopknop met rode afdekknop
- Nullastspanning
- Iedere slijpmolen wordt afzonderlijk getest
- Geproduceerd volgens CE normen

Geleverd met:

- 1 slijpstenen, korrel 36
- 1 Alu oxide witte slijpsteen
- 1 stabiele en instelbare materiaalaanslag
- 2 grote regelbare oogbeschermingsglazen

Order nr.		794004150
Orig. nr.		ME15ES
Spanning	V	230
Slijpsteenafm. (Ø x b x Ø as)	mm	150x25x32
Toerental	min-1	2950
Vermogen motor	W	520
Afmetingen slijpsteen (diameter x b)	mm	200x40x20
Gewicht	kg	17,00
Afmetingen (l x b x h)	mm	555 x 285 x 325
Prijs	€	139,00

OPTIgrind⁺

Dubbele slijpmolen Optigrind

Troeven:

- Uitstekende prijs-prestatieverhouding.
- Modern design
- Onderhoudsvrije motoren
- Kwalitatieve rollagers voor een geluidsarme loop

Kenmerken:

- Zware behuizing
- Gebouwd voor professionele bewerking van metalen.
- Voorzien van nullastspanning
- Lage voltage start (wit) en stop (zwart)
- Met twee Verstelbare werkstukaanslag.
- Met twee verstelbare oogbeschermlenzen.
- Met trillingsdempende gummivoeten.
- Vervaardigd volgens CE-normen.

Geleverd met:

- twee slijpstenen, korrel 36 en 80.

Order nr.		713101505 ^M	713101510 ^M	713101515 ^M	713101520 ^M	713101525 ^M
Orig. nr.		GU15 230V	GU18 230V	GU20 230V	GU20 400V	GU25 400V
Spanning	V	1x230	1x230	1x230	3x400	3x400
Slijpsteenafm. (Ø x b x Ø as)	mm	150x20x16	175x25x32	200x30x32	200x30x32	250x40x32
Toerental	min-1	2850	2850	2850	2850	2850
Vermogen motor	W	450	450	600	600	1500
Gewicht	kg	12,00	14,00	20,00	20,00	37,00
Afmetingen (l x b x h)	mm	410 x 200 x 265	456 x 220 x 291	461 x 246 x 310	461 x 246 x 310	542 x 304 x 365
Prijs	€	153,00	164,00	205,00	226,00	308,00

OPTI^{grind}



ACCESSOIRES

p. 1166

Gecombineerde slijpmolen met slijpsteen en slijpband Optigrind

Troeven:

- Uitstekende prijs-prestatieverhouding.
- Modern design
- Onderhoudsvrije motoren
- Kwalitatieve rollagers voor een geluidsarme loop

Extra informatie:

- Zware behuizing
- Gebouwd voor professionele bewerking van metalen.
- Voorzien van nullastspanning
- Lage voltage start (wit) en stop (zwart)
- Met twee Verstelbare werkstukaanslag.
- Met verstelbare oogbeschermglazen.
- Met trillingsdempende gummivoeten.
- Slijpband voorzien van grafietlaag voorkomt wrijving en hitte
- Vervaardigd volgens CE-normen.

Geleverd met:

- Slijpsteen, korrel 36
- Slijpband, korrel 80

Order nr.	713101570 ^M	713101575 ^M	713101580 ^M
Orig. nr.	GU20S 230V	GU20S 400V	GU25S 400V
Spanning	V	1x230	3x400
Slijpsteenafm. (Ø x b x Ø as)	mm	200x30x32	200x30x32
Toerental	min-1	2850	2850
Vermogen motor	W	600	600
Afmetingen slijpband	mm	75x762	75x762
Diameter afzuiging slijpband	mm	32	32
Hoekverstelling	°	90	90
Gewicht	kg	26,00	26,00
Prijs	€	309,00	339,00

ACCESSOIRES

p. 863



OPTI grind



Robuuste poliermachine voor het polieren van allerlei metalen.

Troeven:

- Uitstekende prijs-prestatieverhouding.
- Modern design
- Onderhoudsvrije motoren
- Kwalitatieve rollagers voor een geluidsarme loop

Kenmerken:

- Zware behuizing
- Gebouwd voor professionele bewerking van metalen.
- Voorzien van nullastspanning
- Lage voltage start (wit) en stop (zwart)
- Met trillingsdempende gummivoeten.
- Vervaardigd volgens CE-normen.

Standaard geleverd met:

- zachte polierschijf
- harde polierschijf.

Optionele machinevoet (713107100 en 713107101) en wandhouder (713107050) leverbaar.

Order nr.		713101540 M	713101545 M	713101550 M
Orig. nr.		GU20P 230V	GU20P 400V	GU25P 400V
Spanning	V	230	3x400	3x400
Vermogen motor	W	600	600	1500
Toerental	tpm	2850	2850	2850
Polierschijfafmetingen (diameter x b x asgat)	mm	200x20x16	200x20x16	250x25x20
Gewicht	kg	18,00	18,00	23,00
Afmetingen (l x b x h)	mm	550 x 200 x 260	550 x 200 x 260	630 x 250 x 320
Prijs	€	287,00	308,00	370,00

OPTIMUM



Wandhouder voor slijpmolens

Troeven:

- Stevige wandhouder
- Met wateropvangbakje

Geschikt voor:

- De meeste slijpmolens met een gewicht van circa 30 kg en gelijkaardig draagvlak
- Slijpmolens GU-, QSM-, SM-, PSM- alsook ME-serie tot ø 250 mm

Order nr.	713107050	
Orig. nr.	MH01	
Gewicht	kg	0,10
Afmetingen (l x b x h)	mm	320 x 320 x 250
Prijs	€	60,50

OPTIMUM



Machinevoet voor slijpmolens.

Troeven:

- Stabiele machinevoet
- Budgetvriendelijk

Geschikt voor:

- De meeste slijpmolens met een gewicht van circa 30 kg en gelijkaardig draagvlak
- Slijpmolens GU-, QSM-, SM-, PSM- alsook ME-serie tot ø 250 mm

Order nr.	713107100	
Orig. nr.	FS10	
Gewicht	kg	5,00
Afmetingen (l x b x h)	mm	320 x 270 x 820
Prijs	€	91,50

OPTIMUM



Robuuste machinevoet voor slijpmolens.

Troeven:

- Robuuste machinevoet
- Met afsluitbare opbergkast en legplank
- Met opvangbakje voor koelvloeistof

Geschikt voor:

- De meeste slijpmolens met een gewicht van circa 75 kg en gelijkaardig draagvlak
- Slijpmolens GU-, QSM-, SM-, PSM- alsook ME-serie tot ø 300 mm

Order nr.	713107103	
Orig. nr.	FS15	
Gewicht	kg	75,00
Afmetingen (l x b x h)	mm	505 x 600 x 790
Prijs	€	276,00

OPTIMUM



Universele machinevoet SSM met afsluitbare opbergkast en opvangbakje voor koelvloeistof. Voor slijpmachines QSM, SM en PSM. Tot Ø 250 mm.

Order nr.	713107101	
Orig. nr.	FS13	
Gewicht	kg	35,00
Afmetingen (l x b x h)	mm	345 x 300 x 785
Prijs	€	329,00

OPTIMUM



Grijze slijpstenen voor slijpmolens en witte nat slijpsteen voor natdrooglijper

Troeven:

- Goede prijs/kwaliteitsverhouding
- In grove korrelsoort K.36 voor het brutere werk
- In fijne korrelsoort K.60 / 80 voor het fijnere werk
- Nat slijpsteen 743107207 uit Edeldkorund, K.120

Geschikt voor:

- Algemeen slijpwerk op slijpmolens
- Geschikt voor het slijpen van HSS
- Nat slijpsteen voor warmtegevoelige toepassing

Tip: kunnen op de meeste slijpmolens gebruikt worden, indien rekening gehouden wordt met het asgat en breedte van de slijpsteen.

Order nr.	Orig. nr.	Slijpsteenafm.(Ø x b x Ø as) mm	Korrel K	Voor type	Gewicht kg	Afmetingen (l x b x h) mm	Prijs €
713107150	3107150	150x20x16	36	GU15	1,00	150 x 150 x 20	13,50
713107155	3107155	150x20x16	80	GU15	1,00	150 x 150 x 20	13,50
743107150	743107150	150x25x32	36	ME15 ME15ES	0,50	150 x 150 x 50	9,90
743107153	743107153	150x25x32	60	ME15 ME15ES	0,50	150 x 150 x 50	9,90
743107207	743107207	200x40x20	120	ME15ES	0,75	200 x 200 x 50	15,90
713107180	3107180	175x25x32	36	GU18	1,00	175 x 175 x 25	19,50
713107185	3107185	175x25x32	80	GU18	1,00	175 x 175 x 25	19,50
713107210	3107210	200x30x32	36	GU20 ME20	1,90	200 x 200 x 30	23,50
713107215	3107215	200x30x32	80	GU20 ME20	1,80	200 x 200 x 30	23,50
713107250	3107250	250x40x32	36	GU25	2,80	250 x 250 x 40	35,90
713107255	3107255	250x40x32	80	GU25	2,88	250 x 250 x 40	35,90
713107270	3107270	300x50x75	36	SM300	3,80	300 x 300 x 50	65,90
713107275	3107275	300x50x75	80	SM300	3,80	300 x 300 x 50	65,90

OPTIMUM



Lappenschijf om te polijsten

Troeven:

- Twee soorten een harde en een zachte lappenschijf
- Te gebruiken met of zonder pasta
- Harde lappenschijf meerdere malen gestikt
- Met versterkt asgat

Geschikt voor:

- voor het polijsten van allerlei materialen
- voor Optimum poliermachines GU-P en PSM

Order nr.	Orig. nr.	Omschrijving	Diameter mm	Voor type	Asgat mm	Afmetingen (l x b x h) mm	Prijs €
713107320	3107320	zacht	200x20	PSM 200	16	200 x 200 x 20	26,50
713107321	3107321	hard	200x20	PSM 200	16	200 x 200 x 20	26,50
713107330	3107330	zacht	250x25	PSM 250	20	250 x 250 x 25	32,90
713107331	3107331	hard	250x25	PSM 250	20	250 x 250 x 25	32,90

Band- en schijfschuurmachines

OPTI²



• Optionele steun- en klitschijf

Schijfschuurmachine voor metaal- en houtbewerking.

Troeven:

- Krachtige motor van 0,9 kW
- Slijptafel kantelbaar van -45 tot +45°
- Verstekaanslag instelbaar van -60 tot +60°
- Stabiele en solide behuizing
- Gebalanceerde aluminium schijfplaat voor een soepele werking
- Met afzuigmond 2 buitendiameters 30/38 mm

Geschikt voor:

- Veel toepassingsgebieden in zowel metaal als hout
- Ruw-, finiseer- en vormslijpen

Standaard geleverd met

1 kleefschijf korrel 60.

Tip: Wij raden het gebruik aan van steun- en klitschijven (velcro) bij vervanging van de schuur schijf, voor een vlugge en eenvoudige schijfwissel.

Order nr.	713310305	
Orig. nr.		TS305
Spanning	V	230
Vermogen motor	kW	0,9
Diameter schijf	mm	305
Toerental	min-1	1420
Afmetingen tafel (b x d)	mm	155x440
Hoek van tafel	°	+/-45
Uitgang voor afzuiging (diameter)		38
Gewicht	kg	30,00
Afmetingen (l x b x h)	mm	440 x 445 x 365
Prijs	€	235,00

metall-wafl

• Schuurband 50x1000 mm

• 750 Watt



In gezwenkte positie

Universele band- en schijfschuurmachine voor metaal- als houtbewerking.

Troeven:

- Tafelmodel met zwenkbare arm
- Krachtige motor van 0,75 kW
- Manuele afstelling van de bandspanning voor een parallelle bandloop
- 2 verstelbare oplegtafels
- Eenvoudige bediening en snelle schuurbandwissel.
- Stofafzuiging aansluitbaar

Geschikt voor:

- Veel toepassingsgebieden in zowel metaal als hout
- Ruw-, finiseer- en vormslijpen en schuren

Standaard geleverd met:

- 1 schuurband 50x1000 korrel 80
- 1 kleefschijf ø150 korrel 80

Tip: Wij raden het gebruik aan van steun- en klitschijven (velcro) bij vervanging van de schuurband, voor een vlugge en eenvoudige schijfwissel.

Order nr.	713700051 	
Orig. nr.		BTS51
Spanning	V	230
Vermogen motor	kW	0,75
Schuurbandafmetingen	mm	1000x50
Schuurbandsnelheid	m/s	22
Afmetingen drukwiel	mm	60x150
Diameter schuurband	mm	150
Diameter afzuiging	mm	
Slijpwiel x asgat	mm	200x45
Gewicht	kg	20,00
Afmetingen (l x b x h)	mm	375 x 230 x 520
Prijs	€	499,00

OPTI^gnd



Universele band- en schijfschuurmachine voor metaal- en houtbewerking.

Troeven:

- Tafelmodel met zwenkbare arm 90°
- Krachtige motor van 1,1 kW
- Manuele afstelling van de bandspanning voor een parallelle bandloop
- Verstelbare slijptafel en bovenaanslag
- Veiligheidsschakelaar IP54
- Eenvoudige bediening en snelle schuurbandwissel
- Stofafzuiging aansluitbaar
- Op aanvraag verkrijgbaar in 3 x 400 V

Geschikt voor:

- Veel toepassingsgebieden in zowel metaal als hout
- Ruw-, finiseer- en vormslijpen en schuren

Standaard geleverd met:

- 1 schuurband 75x1180 korrel 60
- 1 kleefschijf ø150 korrel 60.

Tip: Wij raden het gebruik aan van steun- en klitschijven (velcro) bij vervanging van de schuurschijf, voor een vlotte en eenvoudige schijfwissel.

Order nr.	713311071 ^M	
Orig. nr.	DBS75-230V	
Spanning	V	230
Vermogen motor	kW	1,1
Afmetingen band	mm	75x1180
Diameter schijf	mm	150
Toerental	min-1	1410
Bandsnelheid	m/sec	11
Afzuigbuis binnen	mm	47
Afzuigbuis buiten	mm	50
Zwenkbereik tafel	°	90
Gewicht	kg	62,00
Afmetingen (l x b x h)	mm	665 x 560 x 405
Prijs	€	789,00

metall-soft

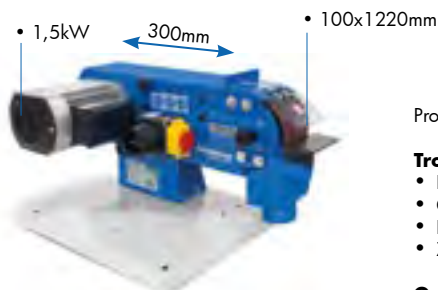

MBSM101-103



Machine op optionele voet

Professionele metaal bandschuurmachine tafelmodel.

Troeven:

- Breed schuurvlak van 100 mm
- Groot horizontaal schuurvlak 300x100mm
- Krachtige motor van 1,5 kW met aluminium behuizing
- Zeer snelle bandwissel

Geschikt voor:

- Voor het slijpen van vlakken, boorden en om af te ronden
- Veeleisende doe-het-zelver, werkplaats, onderhoudsdienst, scholen en opleidingscentra

Kenmerken:

- Uitstekende prestaties dankzij het 130mm diameter grote drukwiel.
- Hoge bandsnelheid.
- Model 400 V met 2 snelheden
- Trillingsvrij dankzij een stabiele constructie.
- Wegklapbare schuurband afdekplaat.
- Automatische naspannen van de schuurband door veerondersteund bandspansysteem.
- Wegklapbare oogbescherming
- Door twee monden kan een stofafzuiging gebruikt worden.

Standaard geleverd met:

- Schuurband 100 x 1220 mm Korrel 60
- Nederlandstalige handleiding, opschriften, CE - kenmerk, en CE-attest volgens Machine richtlijn 2006/42/CE, Laagspanningsrichtlijn 2006/95/CE en EMC Richtlijn 2004/108/CE

Tip: geleverd zonder sokkel, vergeet deze eventueel niet bij te bestellen 713921227.

Order nr.		713921226	713921221
Orig. nr.		MBSM101-130	MBSM103-130
Spanning	V	230	3x400
Vermogen motor	kW	1,5	1,5
Schuurbandafmetingen	mm	100x1220	100x1220
Schuurbandsnelheid	m/s	19	9,5/19
Afmetingen drukwiel	mm	100x130	100x130
Maximum schuurvlak	mm	300x100	300x100
Diameter afzuiging	mm	73	73
Gewicht	kg	37,00	37,00
Afmetingen (l x b x h)	mm	690 x 390 x 360	690 x 390 x 360
Prijs	€	438,00	559,00

metall-soft



Machinervoet voor tafelmodel bandschuurmachine.

Troeven:

- Maak van uw tafelbandschuurmachine een stationair model

Geschikt voor:

- Tafelbandschuurmachines MBSM101-130

Tip: wordt geleverd zonder basisplaat, de basisplaat van de bandschuurmachine wordt gebruikt als basisplaat van de sokkel.

Order nr.		713921227
Orig. nr.		3921227
Gewicht	kg	9,00
Prijs	€	64,90



BS75200400

BS75200400



BS75200400

Professionele metaal bandschuurmachine.

Troeven:

- Krachtige en geluidsarme motor
- Met meest voorkomende schuurbanden op de markt
- Voorzien van een noodstop vooraan dicht bij de werkzone van de bediener
- In de hoogte regelbare slijpunit
- Met wegklapbaar deksel om grotere stukken te slijpen

Geslacht voor:

- Elke werkplaats of industriële omgeving
- Het slijpen van vlakken en boorden, en om af te ronden
- Lasvoorbereidingen

Kenmerken:

- Hoge bandsnelheid
- Stabiele uitvoering
- Aluminium aandrijf wiel met kwaliteitslagers
- Kwaliteits contactwiel van aluminium met rubber belegd
- Vlugge schuurbandwissel dankzij een wegneembare zijkant en opspanhendel
- Voorzien van afzuigkap aan de voorkant en afzuigmond aan de achterkant. Door de monden kan dit toestel aangesloten worden op een afzuiginstallatie
- Eenvoudige afregeling van het drukwiel met regelknop

Standaard geleverd met:

- Machinevoet
- Schuurband Korrel 60
- Nederlandstalige handleiding, opschriften, CE - kenmerk, en CE-attest volgens Machine richtlijn 2006/42/CE, Laagspanningsrichtlijn 2006/95/CE en EMC Richtlijn 2004/108/CE



BS150200400

BS150200400

Order nr.	800170300	800170305	800170310
Orig. nr.	BS75200400	BS75200230	BS150200400
Spanning	V	3x400	230
Vermogen motor	kW	3	3
Afmetingen band	mm	75x2000	75x2000
Snelheid band	m/sec	29	29
Slijpbreedte	mm	75	75
Diameter drukwiel	mm	200	200
Diameter afzuiging (achter)	mm	100	100
Toerental	tpm	2840	2840
Geluidsniveau - LWA (0m)	dB(A)	85	85
Geluidsniveau - LPA (1m) DINISO3744	dB(A)	100,3	100,3
Gewicht	kg	75,00	75,00
Afmetingen (l x b x h)	mm	700 x 490 x 1130	700 x 490 x 1130
Prijs	€	675,00	675,00
			895,00

OPTIMUM



Rubberen contactwiel.

Geschied voor:

- Bandschuurmachines Optimum BSM-serie, Metallkraft MBSM-serie, MW-Mach BS-serie

Tip: Wanneer een stuk uit het bestaande rubberen contactwiel is gesprongen, is het aangeraden deze te vervangen, dit zal u slijpqualiteit verhogen en besparen op schuurbanden

Order nr.	Orig. nr.	Voor machine	Prijs €
891002489	0332107512	BSM75	269,00
891024558	0332115012	BSM150	373,00
891566238	BS75200-11	BS75200 - MBSM75-2000	77,50
800170313	BS150200-11	BS150200-MBSM150-2000	134,00

MACH



Aluminium aandrijf wiel
(zijde motor) van
BS75200400 en
BS75200230.
Onderdeel 59.

Order nr.	Orig. nr.	Prijs
891566239	BS75200-59	€ 61,90

metallkraft



Spaanderzakken voor bandschuurmachines.

Troeven:

- Voor het opvangen van metalen spanen en metaalstof, indien geen afzuiging voorzien is
- Warmtebestendig

Geschied voor:

- Alle metaal bandschuurmachines met een opening van zuigmonden van ø 100 mm.
- Spanenafzuiging AS1600

Order nr.	Orig. nr.	Prijs
713722101	3922002	€ 55,50

metallkraft



AS1400



AS1400



AS1600

Afzuiging voor metaal- en houtstof.

Troeven model AS1400:

- Stofafzuiging voor metaal- en houtstof
- Instapmodel met uitneembare stofbak
- Startklaar geleverd met afzuigslangen ø 75mm van 1 en 2 meter
- Helpt u te voldoen aan de CE normen

Geschied voor :

- Alle kleine tafelbandschuurmachines, band- en schijfschuurmachines en slijpmolens
- Metallkraft MBSM-serie, Holzstar BTS-serie, Optimum GU-serie

Troeven model AS1600:

- Stofafzuiging voor metaal- en houtstof
- Professioneel model met grote en snel verwisselbare filter
- Groot afzuigdebiet
- Startklaar geleverd met stofzak, afzuigslangen ø 100 mm van 1 en 2 meter

Geschied voor:

- de meeste stationaire bandschuurmachines tot 4 kW
- Metallkraft MBSM-serie, Metalworks BS-serie

Order nr.	713922011	713922000
Orig. nr.	AS1400	AS1600
Vermogen motor	kW 0,37	0,75
Diameter aansluiting	mm 2x75	2x100
Debiet	m ³ /u 840	1800
Gewicht	kg 58,00	31,00
Prijs	€ 595,00	929,00

metallkraft



Accessoires voor AS1400 en AS1600.

Order nr.	Orig. nr.	Omschrijving	Voor type	Diameter mm	Langte m	Prijs €
713922003	3922003	afzuigslang	AS1600	100	1	31,50
713922004	3922004	afzuigslang	AS1600	100	2	62,50
713922012	3922012	slang	AS1400	75	1	27,50
713922013	3922013	slang	AS1400	75	2	53,50
713922014	3922014	vervangfilter	AS1400			33,50

metalfast

3 IN 1



Combinatie pijpslijper bandschuurmachine 3 in 1.

Troeven:

- Met 3 bedienvlakken (buizen, vak- en rondslijpen)
- Compact en plaatsbesparend
- Uitstekende prijskwaliteitsverhouding

Geschikt voor:

- Buizen en klassieke slijpwerkzaamheden.
- Ateliers met beperkte ruimtes
- Werkplaatsen, onderhoudsdiensten, scholen en opleidingscentra

Kenmerken:

- De machine heeft 3 bedienvlakken: vooraan voor buizen (met buizenklem), bovenaan voor vlaklijpen en achteraan voor rondslijpen (met werkstuksteun)
- Buisuitslijper: voor diverse metalen buizen en profielen
- Hoekinstelling buizenklem van 30 tot 90°
- Eenvoudige klemming en efficiënte werking met hefboomhendel
- Prismabek met aanslag, instelbaar zonder sleutels
- Sterke motor met 2 snelheden voor verwerken van zowel staal als inox
- Snel wisselen van draairichting en snelheid met keuzeschakelaars
- Kan aangesloten worden op een stofafzuiging dankzij de afzuigmonden
- Gemakkelijke wissel van de schuurband en slijprollen

Veiligheden:

- Voorzien van een aparte noodstop en afzonderlijke start / stopknop
- Nullastspanning
- Wegklapbare veiligheidsafscherming

Standaard met:

- 1 slijpband K36
- 1 slijprol ø 42 mm
- 2 spaanderopvangbakken, voorzien van afzuigaansluiting
- Nederlandstalige handleiding, opschriften, CE - kenmerk, en CE-attest volgens Machine richtlijn 2006/42/CE, Laagspanningsrichtlijn 2006/95/CE en EMC Richtlijn 2004/108/CE

Tip: Wordt geleverd met slechts 1 slijprol ø42 mm af fabriek, vergeet uw andere slijprollen niet bij te bestellen



• Bandschuurmachine/
klassiek slijpen

MACHINES

Order nr.		713921001
Orig. nr.		KRBS101
Spanning	V	3x400
Toerental	min-1	1400/2800
Afmetingen band	mm	100x2000
Vermogen motor	kW	2,5-3,3
Snelheid band	m/sec	15-30
Slijpbare diameters	mm	20-76
Instelbare slijphoek	°	30-90 (0-60)
Diameter afzuiging	mm	2x100
Gewicht	kg	159,00
Afmetingen (l x b x h)	mm	1250 x 750 x 1140
Prijs	€	1.895,00

/metall-soft



Afzonderlijke slijprollen voor pijpslijper KRBS101.

Tip: Per buisdiameter heb je een andere slijprol nodig. Andere maten op aanvraag te verkrijgen

Order nr.	Orig. nr.	Voor type	Diameter mm	Maat inch	Prijs €
713723050	3723050	KRBS100/101		3/8	80,50
713723051	3723051	KRBS100/101		1/2	80,50
713723052	3723052	KRBS100/101	22		80,50
713723053	3723053	KRBS100/101		3/4	87,50
713723054	3723054	KRBS100/101	28		87,50
713723055	3723055	KRBS100/101		1	93,50
713723056	3723056	KRBS100/101	34		93,50
713723057	3723057	KRBS100/101		1-1/4	101,00
713723058	3723058	KRBS100/101	44		101,00
713723059	3723059	KRBS100/101		1-1/2	107,00
713723060	3723060	KRBS100/101	50		107,00
713723061	3723061	KRBS100/101		2	143,00
713723062	3723062	KRBS100/101	62		143,00
713723063	3723063	KRBS100/101		2-1/2	153,00
713723064	3723064	KRBS100/101	78		153,00

Borenslijpmachines



VOOR



NA

Compacte, handige borenslijper.

• Slijphoek 90° - 145°

Troeven:

- Boren slijpen zonder voorkennis
- Geldbesparend, uw eigen boren slijpen
- Tijdwinnend, verlies geen tijd om boren te gaan kopen
- Compact en handig
- Netjes, snel en goed werken
- Gemakkelijk transporteerbaar

Geschikt voor:

- Het slijpen van spiraalboren uit HSS of hardmetaal.
- Iedere werkplaats, onderhoudsdienst, scholen en opleidingscentra, doe-het-zelver

Kenmerken:

- Duurzame diamanten slijpsteen voor perfect slijpen
- Volledige uitrusting met ER spantangen binnen de machine
- De snijkanten van de boor worden in de spantang in een bepaalde positie opgespannen, en in de slijpopeningen ingezet in een vooraf bepaalde volgorde, zodat de snijkanten door kleine rotatiebewegingen van de spantanghouder geslepen worden.

Standaard geleverd met:

- Spantangen van ø 2 tot 13 mm voor GH10T
- Spantangen 11 x ER20 en 17 x ER40 ø 3 tot 30 mm voor GH15T
- Nederlandstalige handleiding, opschriften, CE - kenmerk, en CE-attest volgens Machine richtlijn 2006/42/CE, Laagspanningsrichtlijn 2006/95/CE en EMC Richtlijn 2004/108/CE

Order nr.	713100110	713100115
Algemeen		
Orig. nr.	GH10T	GH15T
Spanning	V 230V/1Ph -50Hz	230V/1Ph -50Hz
Vermogen motor	kW 0,18	0,45
Boorslijpcapaciteit	mm 2 - 13	3 - 30
Traploos instelbare snelheid	min-1 5.300	5.000
Hoek puntslijpen	° 0	
Gewicht	kg 9,50	35,00
Afmetingen (l x b x h)	mm 310 x 180 x 190	450 x 240 x 270
Prijs	€ 494,00	1.289,00

OPTIMUM



Vervang CBN schijf of diamantschijf voor GH10T en GH15T.

Order nr.	713100126	713100127
Algemeen		
Orig. nr.	DSGH10T	DSGH15T
Voor type	GH10T	GH15T
Gewicht	kg 1,00	1,00
Afmetingen (l x b x h)	mm 200 x 120 x 50	
Prijs	€ 95,90	218,00

OPTI grind



BEKLIK DE VIDEO



Universele slijpmachine voor beitels en werktuigen met verschillende geometriën.

Troeven:

- Universeel toepasbaar door veelzijdig zwenken en instellingsopties
- Hoge precisie
- Eenvoudige behandeling en bediening
- Verstelbaar extractietoestel
- Halogeenverlichting (enkel GH20TB 230V)

Geschikt voor:

- Het slijpen van stempels, spiraalboren, elektroden, draaibank gereedschap, centerpunten, enz.

Kenmerken:

- Robuuste machinebehuizing
- Trillingsvrije precisie slijpspindel
- Index kop met 24 vergrendelingsposities

Standaard geleverd met:

- 5 x slijpspantangen \varnothing 4, 6, 8, 10 en 12 mm (GH20TB - 355E S20x2), (GH20T - 5C)
- Korund slijpschijf \varnothing 100x50x \varnothing 20 mm
- Diamant slijpschijf \varnothing 100x50x \varnothing 20 mm
- Africhter
- Bedieningsleutels
- Nederlandstalige handleiding, opschriften, CE - kenmerk, en CE-attest volgens Machine richtlijn 2006/42/CE, Laagspanningsrichtlijn 2006/95/CE en EMC Richtlijn 2004/108/CE.

Order nr.		713100121	713100125
Orig. nr.		GH20TB	GH20T
Spanning	V	1x230	3x400
Vermogen motor	kW	0,25	0,37
Toerental diamantschijf	min-1	5000	5000
Slijpsnelheid	m/s	max.35	max. 35
Toerental motor	min-1	2750	2750
Verplaatsing werktuighouder	mm	140	140
Fijn afstelling werktuighouder	mm	18	18
Fijn afstelling langs	mm	6	6
Verticaal / rugzijde	°	0-40	0-40
Horizontaal / kegelslijpen	°	0-180	0-180
Negatieve hoek	°	0-52	0-52
Vergrendelstand draaihoek	°	15-180	15-180
Spanbereik	mm	1-12	1-16
Spantangtype		355E S20x2	5C
Gewicht	kg	45,00	45,00
Afmetingen (l x b x h)	mm	350 x 450 x 350	350 x 450 x 350
Prijs	€	799,00	1.149,00

Ontbraammachines

#metallcraft



Ontbraammachine voor plaat-materiaal, kokers, boor- en freesgaten en voor lasvoorbereiding.

Troeven:

- Uniek concept zowel draagbaar als stationair
- Toerental traploos instelbaar
- Verschillende ontbraamhoeken 15/30/45°

Geschikt voor:

- Het afwerken van naden met zuivere, braamloze randen, alsook voor het voorbereiden van te verlassen stukken
- Verwerking van staal, inox, Alu, kunststoffen, hout en andere materialen

Kenmerken:

- Met gummivoetjes (snel afneembaar)
- Breedte-instelling traploos instelbaar zonder gereedschap
- Met draagbeugels en kogellagers voor een gemakkelijke manuele voortgang

Veiligheden:

- Automatische veiligheidsuitschakeling en thermische zekering

Standaard geleverd met:

- Freeskop (713992005)
- Wisselplatenset 6 stuks (713992006)

Order nr.	713992000 	
Orig. nr.	KE100	
Ontbraamhoek	°	15/30/45
Ontbraambreedte 15°	mm	5
Ontbraambreedte 30°	mm	6
Ontbraambreedte 45°	mm	7
Spanning	V	230
Vermogen motor	kW	0,75
Toerental	tpm	2000-5000 (traploos)
Gewicht	kg	9,30
Prijs	€	1.079,00

metall-soft



Draagbare ontbraammachine voor plaatmateriaal, profielen, boor- en freesgaten en lasvoorbereiding.

Troeven:

- Draagbaar met 3 draagbeugels
- Lichtgewicht
- Variabele toerentalregeling 3.000 tot 6.000 tpm
- Groot bereik ontbraamhoeken 15/30/37,5/45/60°

Geschikt voor:

- Het afwerken van naden met zuivere, braamloze randen, alsook voor het voorbereiden van te verlassen stukken
- Verwerking van staal, inox, alu en andere materialen

Standaard geleverd met:

- Kunststof opbergkoffer
- 2 x freeshouders voor 6 wisselplaten
- 12 x wisselplaatjes

Order nr.	713990016 	
Orig. nr.	KE16	
Ontbraamhoek	15/30/37,5/45/60	
Ontbraambreedte 15°	mm	12
Ontbraambreedte 30°	mm	14
Ontbraambreedte 37,5°	mm	15,6
Ontbraambreedte 45°	mm	16
Ontbraambreedte 60°	mm	12,7
Spanning	V	230
Vermogen motor	kW	1,1
Toerental	tpm	3000
Gewicht	kg	19,30
Afmetingen (l x b x h)	mm	475 x 296 x 247
Prijs	€	1.095,00

METAALBEWERKINGSMACHINES

Metallkraft metaalbewerking machines voor professionelen en industrie

De meerderheid van de METALLKRAFT machines zijn in de EU geproduceerd door zorgvuldig geselecteerde fabrikanten met veel ervaring. Dankzij deze grondige selectie van die fabrikanten wordt de vraag om de beste kwaliteit steeds beantwoord. Een groot deel van de plaatbewerking machines wordt geproduceerd door de firma "Durmazlar" in Turkije, waar al meer dan 50 jaar geproduceerd wordt.

Wij bieden metaalbewerking machines voor:

- Slijpen
- Ontbramen
- Snijden
- Persen
- Plooien
- Boren
- Zagen
- Accessoires





Cirkelzaagmachines

#metallkraft

ZAAGBLADEN

p. 1152



ZAAGCAPACITEIT		
0°		82mm
45°		56mm



Draagbare, sneldraaiende afkortzaag

Troeven:

- Stabiele en robuuste bouw
- Droog zegend
- Een lichtgewicht met 7,1 kg
- Sneldraaiend
- Vlugge zaagbladwissel door borgpen
- Geringe hitte- en vonkenontwikkeling.
- Krachtige motor met overbelastingsbeveiliging
- Draagbaar

Geschikt voor:

- voor de industrie en bouw voor het zagen van aluminium, staal en roestvrij staalprofielen.
- montage- en onderhoudsbedrijven, standenbouw, werkplaatsen of voorbereiding op laswerkzaamheden, sanitair.
- daar waar de doorslijpschijf niet sterk genoeg is of onzuiver werk levert.

Kenmerken:

- Zaagt in staal, aluminium en roestvast staal zonder bramen of kromtrekking.
- Hoog belastbare motor met hoge aanlopen thermiek en overbelastingsbeveiliging.
- Voorzien van twee handgrepen op twee verscheidene plaatsen, zodat de zaagmachine steeds goed in de hand ligt bij het bedienen.
- Eenvoudige en precieze zaaginstelling.

Geleverd met:

- Kunststof koffer.
- Geleidingsprofiel

Tip: zonder zaagblad geleverd, vergeet uw TCT zaagblad niet bij te bestellen

Order nr.		713840231
Orig. nr.		HKS230
Spanning	V	1x230
Diameter zaagblad x asgat x dikte	mm	230x25,4x2
Vermogen motor	kW	1,7
Zaagsnelheid	min-1	2600
Zaagcapaciteit 90°	mm	82
Zaagcapaciteit 45°	mm	56
Gewicht	kg	9,00
Afmetingen (l x b x h)	mm	520 x 320 x 270
Prijs	€	352,00

metall-wafl



ZAAGBLADEN

p. 1152

ZAAGCAPACITEIT

	Ø	l
1	115mm	105mm
2	115mm	120mm
3	120mm	130mm

Droog zagende afkortzaag, voor het zagen van metaalprofielen zonder koeling.

Troeven:

- Uiterst stabiele en robuuste constructie
- voor het braamloos en vonkenvrij zagen
- Droog zagend
- Draagbaar
- Sneldraaiend
- Motor met soft start

Geschikt voor:

- zagen van profielen en buizen uit staal, ijzer, koper, messing, aluminium, legeringen en roestvrij staal zonder koelmiddel.
- montage- en onderhoudsbedrijven, standenbouw, werkplaatsen of voorbereiding op laswerkzaamheden, sanitair.

Kenmerken:

- Motor met soft start voor het eenvoudig starten van de zaagmachine.
- Spanschroef met snelklemming
- 5 maal langere standtijd door het plaatsen van het materiaal onder 45° in een prisma spanschroef, daarvoor zijn bijkomende prismabekken optioneel te verkrijgen.
- spindelblokkering voor snelle zaagbladwissel.
- Solide onder hoge druk gegoten basis

Standaard geleverd met:

- 1 prismaspanbek,
- Diepteaanslag voor precieze zaagsnedes
- Hoek- en parallelaanslag voor versteksneede tot 45°
- 3 zeskant sleutels (4 / 6 / 8 mm),
- Scharnierende zaagafscherming.

Tip: geleverd zonder TCT zaagblad, vergeet uw zaagblad niet bij te bestellen

Order nr.		713849314
Orig. nr.		MTS356
Spanning	V	1x230
Vermogen motor	kW	2,2
Zaagsnelheid	min-1	1300
Diameter zaagblad x asgat	mm	355 X 25,4
Opening klem	mm	180
Gewicht	kg	24,00
Afmetingen (l x b x h)	mm	680 x 360 x 580
Prijs	€	489,00



Manuele afkortaag met één of twee zaagsnelheden.

Troeven:

- Traag draaiend
- Draaibare zaagkop en spanklem 45° links naar 45° rechts.
- Dubbele spanklem met snelspan inrichting en antibraam houder.
- Tandwieloverbrenging via worm en wormwiel, lopend in een oliebad.
- Voorzien van messing tandwiel tegen breuk bij overbelasting
- Automatische membraankoelpomp met koelmiddelfilter

Geschikt voor:

- het zagen van metalen profielen, zowel buis als vol materiaal staal, ijzer, lichte materialen.

Veiligheden:

- Kantelbare zaagbladafscherming voor optimale veiligheid bij het zagen
- Bedieningshandvat met veiligheidsschakelaar
- Elektrische 24V laagspanningsbediening, overbelastingstermie.
- Vergrendelbare hoofdschakelaar
- Aparte noodstop op 400V modellen

Standaard met :

- Membraankoelpomp met filter
- Lengteaanslag 500mm.
- Nederlandstalige handleiding, opschriften, CE - kenmerk, en CE-attest volgens Machine richtlijn 2006/42/CE, Laagspanningsrichtlijn 2006/95/CE en EMC Richtlijn 2004/108/CE

Tip: worden geleverd zonder zaagblad en sokkel, vergeet deze niet bij te bestellen

Order nr.		713620251	713620253	713620275
Orig. nr.		MKS250N	MKS255N	MKS275N
Spanning	V	1x230	3x400	3x400
Vermogen motor	kW	0,9	0,95-1,32	1,1-1,5
Zaagsnelheid	min-1	40	40/80	40/80
Diameter zaagblad x asgat	mm	250 x 32	250 x 32	275x32
Opening klem	mm	100	100	105
Gewicht	kg	83,00	83,00	98,00
Afmetingen (l x b x h)	mm	800 x 830 x 750	800 x 830 x 750	830 x 900 x 1025
Prijs	€	1.435,00	1.349,00	1.719,00



OPTI LINE



- Ø asdiameter 40
- Tandwieloverbrenging in oliebad
- Koelpomp
- Dubbele klemming
- Inclusief onderstel



ZAAGBLADEN
p. 1152

275

315

ZAAGCAPACITEIT

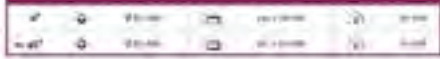

Manuele afkortzaag voor het zagen van staal, ijzer, lichte materialen en profielen.

Troeven:

- Traag draaiend
- Prijsgunstig
- Met zware sokkel
- Asdiameter ø 40 mm
- Draaibare zaagkop 45° links naar 45° rechts.
- Koevloestofstelsysteem

Geschikt voor:

- Het zagen van metalen profielen, zowel buis als vol materiaal staal, ijzer, lichte materialen.

Kenmerken:

- Stabiele en robuuste constructie
- Krachtige en stille motor
- Centrisch spannende en dubbele spanklem met snelspan inrichting, met 4 geleidingen en 4 afzonderlijk verstelbare spanbekken, voorzien van antibraam inrichting.
- Tandwieloverbrenging via worm en wormwiel, lopend in een oliebad.
- Gesloten koevloestofinrichting met uitneembare koelmiddelreservoir, voor eenvoudig reinigen, met geïntegreerde krachtige koelpomp
- Duidelijk afleesbare schaalverdeling maken precies werken mogelijk
- Sokkel is voorzien van gaten langs beide zijden voor de aanbouw van de optionele rollenbaan MSR4H, MSR7H en MSR10H

Veiligheden:

- Kantelbare zaagbladafscherming voor optimale veiligheid bij het zagen
- Geïntegreerde aan/uit drukknop in het veiligheidshandvat
- Elektrische 24 V laagspanningsbediening en overbelastingthermie.
- Aparte noodstop
- Vergrendelbare hoofdschakelaar

Standaard geleverd met:

- Sokkel
- Koelpomp en uitneembare koeltank

Tip: wordt geleverd zonder zaagblad, vergeet uw zaagblad niet bij te bestellen

Order nr.		713302275	713302300
Orig. nr.		CS275	CS315
Spanning	V	3x400	3x400
Vermogen motor	kW	2,0-1,40	1,50,75
Vermogen koelpomp	W	40	40
Zaagsnelheid	min-1	41/82	19/38
Diameter zaagblad x asgat	mm	275 x 40	315 x 40
Opening klem	mm	110	135
Gewicht	kg	160,00	230,00
Afmetingen (l x b x h)	mm	940 x 560 x 1510	910 x 546 x 1759
Prijs	€	1.955,00	2.065,00

MACHINES



ZAAGBLADEN
p. 1152

MADE IN EUROPE

315

ZAAGCAPACITEIT	
Ø 315mm	Ø 300mm
Ø 254mm	Ø 200mm
115x120mm	100x120mm
Ø 80mm	Ø 70mm

Manuele cirkelzaagmachine met zaagblad \varnothing 315 mm, twee snelheden en onder hoek verstelbare zaagkop en spanschroef. "Made in EU".

Troeven:

- Traag draaiend
- Draaibare zaagkop en spanklem 45° links naar 45° rechts.
- Dubbele spanklem met snelspan inrichting en antibraam houder.
- Tandwieloverbrenging via worm en wormwiel, lopend in een oliebad.
- Voorzien van messing tandwiel tegen breuk bij overbelasting
- Automatische membraankoelpomp met koelmiddelfilter

Geschikt voor:

- Het zagen van metalen profielen, zowel buis als vol materiaal staal, ijzer, lichte materialen.

Veiligheden:

- Kantelbare zaagbladafscherming voor optimale veiligheid bij het zagen
- Bedieningshandvat met veiligheidsschakelaar
- Elektrische 24 V laagspanningsbediening, overbelastingsthermiek.
- Vergrendelbare hoofdschakelaar
- Aparte noodstop

Standaard met :

- Membraankoelpomp met filter
- Bedieningsleutels
- Lengteaanslag 500mm.
- Nederlandstalige handleiding, opschriften, CE - kenmerk, en CE-attest volgens Machine richtlijn 2006/42/CE, laagspanningsrichtlijn 2006/95/CE en EMC Richtlijn 2004/108/CE

Tip: worden geleverd zonder zaagblad en sokkel, vergeet deze niet bij te bestellen

Order nr.	713620303	
Orig. nr.	MKS315N 400V	
Spanning	V	3x400
Vermogen motor	kW	1,5-2,2
Zaagsnelheid	min-1	40/80
Diameter zaagblad x asgat	mm	315 x 32
Opening klem	mm	120
Gewicht	kg	150,00
Afmetingen (l x b x h)	mm	1000 x 1150 x 1475
Prijs	€	2.135,00

metall-wafl



ZAAGBLADEN

p. 1152

MADE IN EUROPE

315

ZAAGCAPACITEIT	
45°	90°
100mm	80mm
65mm	60mm
120x70mm	80x70mm
85mm	70mm

Manuele cirkelzaagmachine met slipkoppeling, zaagblad \varnothing 315 mm, twee snelheden en onder hoek verstelbare zaagkop en spanschroef. "Made in EU".

Troeven:

- Traag draaiend
- Uitgerust **met een slipkoppeling**, waardoor het breken van het zaagblad wordt uitgesloten
- Draaibare zaagkop en spanklem 45° links naar 45° rechts.
- Dubbele spanklem met snelspan inrichting en antibraam houder.
- Tandwieloverbrenging via worm en wormwiel, lopend in een oliebad.
- Voorzien van messing tandwiel tegen breuk bij overbelasting
- Automatische membraankoelpomp met koelmiddelfilter
- MKS316R geschikt om RVS te zagen, mits aangepast zaagblad

Geschikt voor:

- Het zagen van metalen profielen, zowel buis als vol materiaal staal, ijzer, lichte materialen.

Veiligheden:

- Kantelbare zaagbladafscherming voor optimale veiligheid bij het zagen
- Bedieningshandvat met veiligheidsschakelaar
- Elektrische 24 V laagspanningsbediening, overbelastingstermiek.
- Vergrendelbare hoofdschakelaar
- Aparte noodstop

Standaard met :

- Membraankoelpomp met filter
- Materiaal ondersteuningsrol
- Bedieningsleutels
- Lengteaanslag 500 mm.
- Nederlandstalige handleiding, opschriften, CE - kenmerk, en CE-attest volgens Machine richtlijn 2006/42/CE, Laagspanningsrichtlijn 2006/95/CE en EMC Richtlijn 2004/108/CE

Tip: worden geleverd zonder zaagblad en sokkel, vergeet deze niet bij te bestellen

Order nr.		713621315	713621316
Orig. nr.		MKS315R 400V	MKS316R
Spanning	V	3x400	3x400
Vermogen motor	kW	1,5-2,2	1.32-1.91
Zaagsnelheid	min-1	40/80	20/40
Diameter zaagblad x asgat	mm	315x32	315x32
Opening klem	mm	120	120
Gewicht	kg	170,00	170,00
Afmetingen (l x b x h)	mm	1150 x 1000 x 1475	1475 x 1000 x 1150
Prijs	€	2.869,00	2.855,00

metall-werk

ZAAGBLADEN

p. 1152

MADE IN EUROPE

350

• Veiligheidshandvat

• Oliebad

• Dubbele klemming

• Koelpomp

• Optioneel onderstel

Manuele cirkelzaagmachine met zaagblad \varnothing 350 mm, twee snelheden en onder hoek verstelbare zaagkop en spanskroef. "Made in EU".

Troeven:

- Traag draaiend
- Grote zaagcapaciteiten
- Draaibare zaagkop en spansklem 45° links naar 45° rechts.
- Dubbele spansklem met snelspan inrichting en antibraam houder.
- Tandwieloverbrenging via worm en wormwiel, lopend in een oliebad.
- Voorzien van messing tandwiel tegen breuk bij overbelasting
- Automatische membraankoelpomp met koelmiddelfilter
- MKS351 geschikt om RVS te zagen, mits aangepast zaagblad

Geschikt voor:

- Het zagen van metalen profielen, zowel buis als vol materiaal staal, ijzer, lichte materialen.

Veiligheden:

- Kantelbare zaagbladafscherming voor optimale veiligheid bij het zagen
- Bedieningshandvat met veiligheidsschakelaar
- Elektrische 24 V laagspanningsbediening, overbelastingsthermie.
- Vergrendelbare hoofdschakelaar
- Aparte noodstop

Standaard met :

- Membraankoelpomp met filter
- Materiaal ondersteuningsrol
- Bedieningsleutels
- Lengteaanslag 500 mm
- Nederlandstalige handleiding, opschriften, CE - kenmerk, en CE-attest volgens Machine richtlijn 2006/42/CE, Laagspanningsrichtlijn 2006/95/CE en EMC Richtlijn 2004/108/CE

Tip: worden geleverd zonder zaagblad en sokkel, vergeet deze niet bij te bestellen

ZAAGCAPACITEIT		
	45°	0°
\varnothing	100mm	100mm
L	40mm	35mm
H	120x80mm	80x80mm
B	100mm	80mm

Order nr.

713621350 

713621351 

Orig. nr.		MKS350	MKS351
Spanning	V	3x400	3x400
Vermogen motor	kW	1,8;2,4	1,5;2,2
Zaagsnelheid	min-1	40/80	20/40
Diameter zaagblad x asgat	mm	350 x 32	350x32
Opening klem	mm	120	120
Gewicht	kg	210,00	210,00
Afmetingen (l x b x h)	mm	1000 x 1200 x 1475	1000 x 1200 x 1475
Prijs	€	3.129,00	3.295,00

metabo-hilti

ZAAGBLADEN

p. 1152

MADE IN EUROPE

NEW

350



Halfautomatische cirkelzaagmachine met zaagblad \varnothing 350 mm, "Made in EU"

Troeven:

- Halfautomatische uitvoering
- Traag draaiend
- Voetpedaalbediening met noodstop
- Draaibare zaagkop en spanklem 45° links naar 45° rechts
- Dubbele spanklem met snelspan inrichting en antibraam houder
- Tandwieloverbrenging via worm en wormwiel, lopend in een oliebad
- Voorzien van messing tandwiel tegen breuk bij overbelasting
- Koelmiddel straalverdeling voor betere smering van het zaagblad

Functie van de halfautomatische uitvoering:

- Sluiten van de machineklem en activering van de motor van de cirkelzaag
- Dalen van de zaagkop tot de zaagsnede
- Behouden van de activatie van de motor en terugkeer van de zaagkop tot zijn begin instelpositie
- Openen van de machineklem

Geschikt voor:

- Het zagen van metalen profielen, zowel buis als vol materiaal staal, ijzer, lichte materialen.

Veiligheden:

- Kantelbare zaagbladafscherming voor optimale veiligheid bij het zagen
- Bedieningshandvat met veiligheidsschakelaar
- Elektrische 24 V laagspanningsbediening, overbelastingsthermie
- Vergrendelbare hoofdschakelaar
- Aparte noodstop

Standaard met :

- Koelsysteem
- Sokkel
- Voetpedaalbediening met noodstop
- Materiaal ondersteuningsrol
- Bedieningsleutels
- Lengteaanslag 500 mm
- Nederlandstalige handleiding, opschriften, CE - kenmerk, en CE-attest volgens Machine richtlijn 2006/42/CE, Laagspanningsrichtlijn 2006/95/CE en EMC Richtlijn 2004/108/CE

Tip: worden geleverd zonder zaagblad, vergeet deze niet bij te bestellen.

ZAAGCAPACITEIT		
	Ø	L x B
➔	100mm	80mm
➔	50mm	50mm
➔	120x80mm	80x80mm
➔	100mm	80mm

Order nr.	713620352	
Orig. nr.	MKS350H	
Vermogen motor	kW	1.8/2.4
Zaagsnelheid	min-1	40/80
Diameter zaagblad x asgat	mm	350 x 32
Opening klem	mm	120
Gewicht	kg	280,00
Afmetingen (l x b x h)	mm	1000 x 1200 x 1475
Prijs	€	6.460,00

MACHINES

metallkraft

ZAAGBLADEN

p. 1152

MADE IN EUROPE

NEW

350



MACHINES

Halfautomatische verticale afkortzaag met verticale zwaluwstaartgeleiding met zaagblad \varnothing 350 mm, "Made in EU".

Troeven:

- Halfautomatische uitvoering
- Traag draaiend
- **Verticale geleiding over zwaluwstaart**
- Draaibare zaagkop en spanklem 45° links naar 60° rechts
- Tafel met vaste eindelopen op -45° , 0° , $+45^\circ$, $+60^\circ$ voor een vlugge afstelling
- Zaagdiepte aanslag, zowel hoogste punt als laagste punt kunnen ingesteld worden, tijdsbesparend
- Tandwieloverbrenging via worm en wormwiel, lopend in een oliebad
- Voorzien van messing tandwiel tegen breuk bij overbelasting
- Pneumatische spanklem en antibraam houder garandeert een precieze en braamvrije zaagsnede
- Koelmiddel straalverdeling voor betere smering van het zaagblad
- Ook beschikbaar in manuele uitvoering met zaagblad 315 of 350

Functie van de halfautomatische uitvoering:

- Sluiten van de machineklem en activering van de motor van de cirkelzaag.
- Dalen van de zaagkop tot de zaagsnede
- Behouden van de activatie van de motor en terugkeer van de zaagkop tot zijn begin instelpositie
- Openen van de machineklem

Geschikt voor:

- Het zagen van metalen profielen, zowel buis als vol materiaal staal, ijzer, lichte materialen

Veiligheden:

- Zaagbladafscherming voor optimale veiligheid bij het zagen
- Elektrische 24 V laagspanningsbediening, overbelastingsthermiek
- Vergrendelbare hoofdschakelaar
- Aparte noodstop

Standaard met :

- Koelsysteem
- Sokkel
- Materiaal ondersteuningsrol
- Materiaal toevoerrollenbaan van 1000 mm
- Bedieningsleutels
- Lengteaanslag 500 mm
- Nederlandstalige handleiding, opschriften, CE - kenmerk, en CE-attest volgens Machine richtlijn 2006/42/CE, Laagspanningsrichtlijn 2006/95/CE en EMC Richtlijn 2004/108/CE

Tip: worden geleverd zonder zaagblad, vergeet deze niet bij te bestellen

ZAAGCAPACITEIT				
MKS 350 VH				
	●	○	□	▭
90°	100	100	90x90	170x90
45°	100	100	90x90	125x90
45°	100	100	90x90	125x90
90°	90	90	90x90	90x90

Order nr.

Orig. nr.		713623350 
Spanning	V	MKS350VH 400V
Diameter zaagblad x asgat x dikte	mm	3x400
Vermogen motor	kW	350x32x2.5
Zaagsnelheid	min-1	2.5
Opening klem	mm	36/72
Diameter zaagblad	mm	185
Gewicht	kg	350
Afmetingen (l x b x h)	mm	480,00
Prijs	€	2640 x 1200 x 2000
		7.780,00

MADE IN EUROPE
400

LMS400



LMS400H



LMS400P

Manuele sneldraaiende afkortaag met zaaglad \varnothing 400 mm **voor aluminium** en non-ferrometalen. "Made in EU"

Troeven:

- Sneldraaiend
- Precieze zaagsnede
- Braamloos zagen en verstek zagen van aluminium
- Dubbele klemming
- Met kunststofbelegde alu spanbekken

Geschikt voor:

- Industrie, montagebedrijven, productie van ramen, keukens, sectionale poorten, etc,
- Aluminium en non-ferrometalen (Let op: niet geschikt voor volmetalen, staal, of andere harde metaal soorten. Hiervoor raden wij de Metallkraft MKS-machines aan)

Kenmerken:

- Stabiele en robuuste uitvoering.
- Draaibare machinekop 45° links en 45° rechts.
- Eenvoudig 45° draaien van de zaagkop door positiestops.
- Op rollagers gemonteerde zaagkop en schaal.
- Op rollagers gemonteerde zaagas
- **LMS400:** manuele uitvoering, neigbare zaagkop 45° naar links van de zaagsnede
- **LMS400P met pneumatische spanklem** neigbare zaagkop 45° naar links van de zaagsnede, met voetpedaalbediening.
- **LMS400H in halfautomatische uitvoering** met 2 pneumatische snelspanklemmen

Veiligheden:

- Elektrische bediening 24V en overbelastingsthermiek
- Vergrendelbare hoofdschakelaar
- Bedieningshandvat met veiligheidsschakelaar (LMS400/P)
- Kantelbare zaagbladafscherming voor optimale veiligheid bij het zagen
- Volledige zaagzone omkasting bij LMS400H
- Aparte noodstop

Standaard geleverd met:

- Lengteanslag 500 mm
- Bedieningsleutels
- Sokkel en materiaal rolsteen enkel bij LMS400H
- Nederlandstalige handleiding, opschriften, CE - kenmerk, en CE-attest volgens Machine richtlijn 2006/42/CE, Laagspanningsrichtlijn 2006/95/CE en EMC Richtlijn 2004/108/CE

Tip: worden geleverd zonder zaagblad en sokkel, vergeet deze niet bij te bestellen

ZAAGCAPACITEIT				
90°	50	140	110 x 110	160 x 130
45°	60	120	100 x 100	130 x 130
$45^\circ +$	80	120	100 x 100	150 x 130

Order nr.		713625400	713625402	713625401
Orig. nr.		LMS400	LMS400P	LMS400H
Spanning	V	3x400	3x400	3x400
Vermogen motor	kW	2,2	2,2	2,2
Zaagsnelheid	min-1	3000	3000	3000
Diameter zaagblad	mm	400	400	400
Gewicht	kg	160,00	210,00	210,00
Afmetingen (l x b x h)	mm	1500 x 1000 x 900	1500 x 1000 x 1600	1500 x 1000 x 1600
Prijs	€	3.195,00	3.885,00	6.580,00



Universele machinevoet MKS- en LMS-serie.

Order nr.		713642571	713643171
Orig. nr.		UM25	UM35
Voor type		MKS250-MKS255N-MKS251	MKS315-350 LMS400
Gewicht	kg	19,50	25,00
Prijs	€	237,00	237,00

Lintzaagmachines

OPTI SAW



NEW

ZAAGBLADEN

p. 1156



ZAAGCAPACITEIT

Hoek	Ø	□	▭
90°	90	85	100 x 85
45° LL	60	65	60 x 65
60° LL	-	-	-

Draagbare bandzaagmachine onder hoek verstelbaar tot 45° met hoge zaagprecisie, en geluidsarm

Troeven:

- Draagbaar
- Zaagbeugel onder hoek verstelbaar van 0° tot 45°
- Vario aandrijvingsmotor met lage toerental en koolstofborstels voor een 10x langere levensduur
- Gietijzeren machineklem.

Geschikt voor:

- Op werven, bouw, broeikas herstel, servicewagens, etc.
- Het zagen van buizen en profielen van staal, ijzer, lichte materialen

Kenmerken:

- 2-punts kogelgelagerde zaagleiding waardoor uitstekende zaagloop en optimale zaagsnede verkregen worden.
- Bodemplaat met antislip voeten uitgerust.
- Vibratie- en slijtarm dankzij speciaal ontworpen aandrijving over 2 tandwielen uit gehard staal.
- Zaagbeugel kan bijgesteld worden

Standaard geleverd met:

- Bimetaal zaagblad.
- Materiaalaanslag
- Nederlandstalige handleiding, opschriften, CE-kenmerk, en CE-attest volgens Machine richtlijn 2006/42/CE, Laagspanningsrichtlijn 2006/95/CE en EMC Richtlijn 2004/108/CE

Order nr. **713300070**

Algemeen

Orig. nr. SP11V

Vermogen

Spanning V 230
Vermogen motor kW 0.85

Afmetingen

Zaagsnelheid m/min 30-80
Afmetingen zaaglint (l x h x d) mm 1335x13x0.65
Opheffen-dalen zaagbeugel Manueel
Lengte met gesloten spanklem mm 650
Breedte zonder materiaalaanslag mm 290
Breedte met materiaalaanslag mm 670
Hoogte onderste eindpositie zaagbeugel mm 450
Hoogte bovenste eindpositie zaagbeugel mm 630
Gewicht kg 19,00
Afmetingen (l x b x h) mm 650 x 290 x 450

Prijs € **499,00**

OPTI LEW

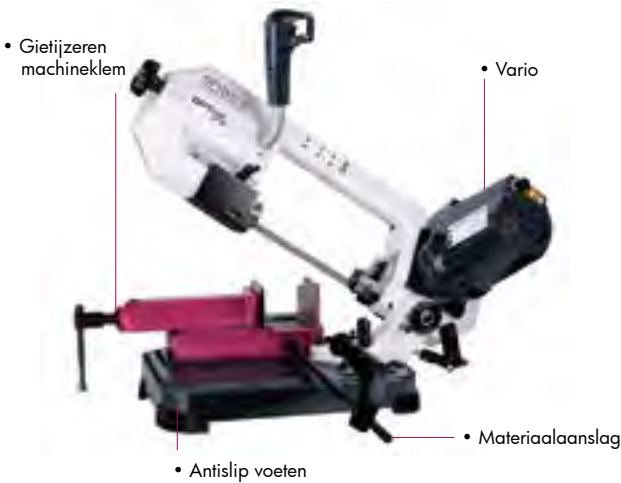

NEW

ZAAGBLADEN
p. 1156



ZAAGCAPACITEIT

	○	□	▭
90°	125 mm	125 mm	120x125 mm
45° links/rechts	85 mm	85 mm	85x85 mm
60° links/rechts	50 mm	50 mm	50x50 mm

Draagbare bandzaagmachine onder hoek verstelbaar tot 60° met hoge zaagprecisie, en geluidsarm

Troeven:

- Draagbaar
- Zaagbeugel onder hoek verstelbaar van 0° tot 60°
- Vario aandrijvingsmotor met lage toerental en koolstofborstels voor een 10x langere levensduur
- Gietijzeren machineklem.

Geschikt voor:

- Op werven, bouw, broeikas herstel, servicewagens, etc.
- Het zagen van buizen en profielen van staal, ijzer, lichte materialen

Kenmerken:

- 2-punts kogelgelagerde zaagleiding waardoor uitstekende zaagloop en optimale zaagsnede verkregen worden.
- Bodemplaat met antislip voeten uitgerust.
- Vibratie- en slijtarm dankzij speciaal ontworpen aandrijving over 2 tandwielen uit gehard staal.
- Zaagbeugel kan bijgesteld worden

Standaard geleverd met:

- Bimetaal zaagblad.
- Materiaalaanslag
- Nederlandstalige handleiding, opschriften, CE-kenmerk, en CE-attest volgens Machine richtlijn 2006/42/CE, Laagspanningsrichtlijn 2006/95/CE en EMC Richtlijn 2004/108/CE

Order nr.	713300075 M	
Algemeen		
Orig. nr.	SP13V	
Vermogen		
Spanning	V	1x230
Vermogen motor	kW	0.85
Afmetingen		
Zaagsnelheid	m/min	30-80
Afmetingen zaaglint (l x h x d)	mm	1440x13x0.65
Opheffen-dalen zaagbeugel	manueel	
Breedte zonder materiaalaanslag	mm	300
Breedte met materiaalaanslag	mm	650
Hoogte onderste eindpositie zaagbeugel	mm	420
Hoogte bovenste eindpositie zaagbeugel	mm	680
Gewicht	kg	19,50
Afmetingen (l x b x h)	mm	720 x 300 x 420
Prijs	€	549,00

OPTIMUM



S100G

- Automatisch dalen zaagbeugel



Geïllustreerd met optionele sokkel

ZAAGBLADEN
p. 1156



ZAAGCAPACITEIT

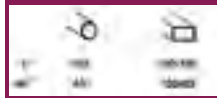

Lichte en handige metaal bandzaagmachine met automatisch dalen zaagbeugel.

Troeven:

- Automatisch dalen van de zaagbeugel in 3 posities in stelbaar
- Heel betrouwbaar en degelijke kwaliteit
- Licht en voorzien van een ergonomische hendel

Geschikt voor:

- Universeel gebruik, in elke servicewagen, werkplaats, hobby, landbouwdoeleinden.

Kenmerken:

- Automatische afslag na het doorzagen.
- Onder verstek instelbare zaagbeugel van 0° tot 45°
- Gepatenteerde snelspan klemming
- 3-voudige kogelgelagerde bandzaaggeleiding
- Zaagbeugel daalt door zijn eigen gewicht. Dalingsdruk van de zaagbeugel in 3 posities instelbaar.
- Zaagbeugel kan vast worden gezet voor transport.

Standaard geleverd met:

- Bi-metaal lintzaag
- Materiaalaanslag.
- Nederlandstalige handleiding, opschriften, CE-kenmerk, en CE-attest volgens Machine richtlijn 2006/42/CE, Laagspanningsrichtlijn 2006/95/CE en EMC Richtlijn 2004/108/CE

Order nr.	713300100	
Algemeen		
Orig. nr.	S100G	
Vermogen		
Spanning	V	1x230
Vermogen motor	kW	0,37
Afmetingen		
Zaagsnelheid	m/min	45
Afmetingen zaaglint (l x h x d)	mm	1470x13x0,65
Opheffen zaagbeugel		manueel
Lengte met gesloten spanklem	mm	850
Lengte met geopende spanklem	mm	950
Breedte zonder materiaalaanslag	mm	300
Breedte met materiaalaanslag	mm	660
Hoogte onderste eindpositie zaagbeugel	mm	680
Hoogte bovenste eindpositie zaagbeugel	mm	820
Gewicht	kg	23,00
Afmetingen (l x b x h)	mm	720 x 380 x 460
Prijs	€	635,00

OPTIMUM



Universele stalen sokkel voor S100G en MTS356.

- Stabiel
- Plaats besparend
- Opklapbaar
- Licht transporteerbaar

Order nr.	713351490	
Orig. nr.	3630000	
Gewicht	kg	10,50
Afmetingen (l x b x h)	mm	790 x 508 x 160
Prijs	€	79,90

metallsoft



ZAAGBLADEN
p. 1152



ZAAGCAPACITEIT

	Ø	□	▭
90°	105	101	101 x 105
45°	70	70	70 x 70
45°+	-	-	-

Lichte, handige en professionele bandzaagmachines met variabele zaagsnelheid. "Made in EU".

Troeven:

- Bijzonder geruisloze vario-motor.
- Draagbaar
- Zaagbeugel onder hoek verstelbaar van 0° tot 45°
- Gietijzeren machineklem

Geschikt voor:

- Op werven, bouw, broeikas herstel, servicewagens, etc.
- Het zagen van buizen en profielen van staal, ijzer, lichte materialen

Kenmerken:

- Toerental variabel regelbaar van 30 tot 80m/min
- Dankzij de speciaal ontworpen motor met een dito aandrijving naar het zaagwiel trillingsarm en 60% geruislozer dan gelijkaardige zaagmachines
- Zaagspanning regelbaar d.m.v. instelknop aan de voorkant van de zaagbeugel
- Goed afleesbare schaal voor de aanduiding van de hoekinstelling van de zaagbeugel op 1° nauwkeurig
- Geschikt voor zowel droog- als natzagen
- Kogellagers met extreem sterke gietijzeren loopwielen
- Langere levensduur van de zaagbeugel door afzonderlijke zaagbandgeleidingen

Standaard geleverd met:

- Materiaalaanslag
- Bi-metaal zaagblad
- Nederlandstalige handleiding, opschriften, CE-kenmerk, en CE-attest volgens Machine richtlijn 2006/42/CE, Laagspanningsrichtlijn 2006/95/CE en EMC Richtlijn 2004/108/CE

Order nr.	713630105		
Algemeen			
Orig. nr.	MBS105		
Vermogen			
Spanning	V	1x230	
Vermogen motor	kW	0,85	
Afmetingen			
Zaagsnelheid	m/min	30-80 Vario	
Afmetingen zaaglint (l x h x d)	mm	1335x13x0.65	
Afmetingen voet (b x d)	mm	720x320	
Gewicht	kg	18,00	
Afmetingen (l x b x h)	mm	720 x 320 x 450	
Prijs	€	496,00	

metabo



ZAAGBLADEN

p. 1152



ZAAGCAPACITEIT

	○	□	▭
90°	125	125	130 x 125
45° ll.	80	80	80 x 80
60° ll.	50	50	50 x 50

Lichte, handige en professionele bandzaagmachines met variabele zaagsnelheid. "Made in EU".

Troeven:

- Bijzonder geruisloze vario-motor
- Draagbaar
- Zaagbeugel onder hoek verstelbaar van 0° tot 60°
- Gietijzeren machineklem

Geschikt voor:

- Op werven, bouw, broeikas herstel, servicewagens, etc.
- Het zagen van buizen en profielen van staal, ijzer, lichte materialen

Kenmerken:

- Toerental variabel regelbaar van 30 tot 80m/min
- Dankzij de speciaal ontworpen motor met een dito aandrijving naar het zaagwiel trillingsarm en 60% geruislozer dan gelijkaardige zaagmachines.
- Zaagspanning regelbaar d.m.v. instelknop aan de voorkant van de zaagbeugel
- Goed afleesbare schaal voor de aanduiding van de hoekinstelling van de zaagbeugel op 1° nauwkeurig
- Geschikt voor zowel droog- als natzagen
- Kogellagers met extreem sterke gietijzeren loopwielen
- Langere levensduur van de zaagbeugel door afzonderlijke zaagbandgeleidingen

Standaard geleverd met:

- Materiaalaanslag
- Bi-metaal zaagblad
- Nederlandstalige handleiding, opschriften, CE-kenmerk, en CE-attest volgens Machine richtlijn 2006/42/CE, Laagspanningsrichtlijn 2006/95/CE en EMC Richtlijn 2004/108/CE

Order nr.	713630125	
Algemeen		
Orig. nr.	MBS125	
Vermogen		
Spanning	V	1x230
Vermogen motor	kW	1,2
Afmetingen		
Zaagsnelheid	m/min	30-80 Vario
Afmetingen zaaglint (l x h x d)	mm	1440x13x0.65
Afmetingen voet (b x d)	mm	720x320
Gewicht	kg	19,00
Afmetingen (l x b x h)	mm	720 x 320 x 470
Prijs	€	679,00

#metallsaif



ZAAGBLADEN

p. 1152



ZAAGCAPACITEIT

	Ø	□	▭
90°	150	140	150 x 140
45° II.	100	90	100 x 90
60° III.	70	65	65 x 70

Lichte, handige en professionele bandzaagmachines **met variabele zaagsnelheid**. "Made in EU".

Troeven:

- Bijzonder geruisloze vario-motor
- Draagbaar
- Zaagbeugel onder hoek verstelbaar van 0° tot 60°
- Gietijzeren machineklem

Geschikt voor:

- Op werven, bouw, broeikas herstel, servicewagens, etc.
- Het zagen van buizen en profielen van staal, ijzer, lichte materialen

Kenmerken:

- Toerental variabel regelbaar van 30 tot 80m/min
- Dankzij de speciaal ontworpen motor met een dito aandrijving naar het zaagwiel trillingsarm en 60% geruislozer dan gelijkaardige zaagmachines
- Zaagspanning regelbaar d.m.v. instelknop aan de voorkant van de zaagbeugel
- Goed afleesbare schaal voor de aanduiding van de hoekinstelling van de zaagbeugel op 1° nauwkeurig
- Geschikt voor zowel droog- als natzagen
- Kogellagers met extreem sterke gietijzeren loopwielen
- Langere levensduur van de zaagbeugel door afzonderlijke zaagbandgeleidingen

Standaard geleverd met:

- Materiaalaanslag
- Bi-metaal zaagblad
- Nederlandstalige handleiding, opschriften, CE-kenmerk, en CE-attest volgens Machine richtlijn 2006/42/CE, Laagspanningsrichtlijn 2006/95/CE en EMC Richtlijn 2004/108/CE

Order nr.	713630150	
Algemeen		
Orig. nr.	MBS150	
Vermogen		
Spanning	V	1x230
Vermogen motor	kW	1,5
Afmetingen		
Zaagsnelheid	m/min	30-80 Vario
Afmetingen zaaglint (l x h x d)	mm	1735x13x0.65
Afmetingen voet (b x d)	mm	1000x390
Gewicht	kg	30,00
Afmetingen (l x b x h)	mm	1000 x 390 x 590
Prijs	€	1.115,00

OPTIMUM



- Aparte noodstop
- Aparte start/stop
- 3 snelheden 22-31-55 m/min
- Hydraulische daalcilinder
- 3 schakelaars

• Inclusief mobiele sokkel

DUBBEL VERSTEK:
LINKS EN RECHTS



ZAAGCAPACITEIT

	0°	+/-45°	60°
⌀	⌀ 126 mm	⌀ 90 mm	⌀ 45 mm
⊠	100 x 145 mm	85 x 70 mm	56 x 45 mm

Mobiele bandzaagmachine voor het zagen van metaal en kunststof.

Troeven:

- Onder hoek verstelbaar -45° tot +60°
- Vrijrijdbare sokkel
- Krachtige en stille 1100 Watt motor
- Daalvoeding
- Snelspanklemming

Geschikt voor:

- Lichte zaagwerkzaamheden, de veeleisende doe-het-zelver

Kenmerken:

- Precisie afwerking volgens Optimum normen.
- Gecontroleerd dalen van de zaagbeugel dankzij een traploos instelbare hydraulische cilinder.
- Automatische afslag na het doorzagen
- Bodemplaat, zwenkarm en zaagbeugel van degelijk gietstaal
- 3-voudige kogelgelagerde bandzaaggeleiding
- Drie zaagsnelheden door het verleggen van de aandrijfriem geven een brede keuze in de te zagen materialen
- Verplaatsbare zaagbladgeleiding door middel van handwiel
- Duidelijk afleesbare schaalverdeling

Veiligheden:

- Uitgerust met een aparte noodstop, aparte start en stopknop
- 24V lage veiligheids spanning
- Snaarbehuizing alsook de zaagbeugel zijn voorzien van een veiligheidsschakelaar

Standaard geleverd met:

- Bi-metaal zaagblad 10-14 tpi
- Materiaalaanslag.
- Nederlandstalige handleiding, opschriften, CE - kenmerk, en CE-attest volgens Machine richtlijn 2006/42/CE, Laagspanningsrichtlijn 2006/95/CE en EMC Richtlijn 2004/108/CE

Order nr. **713300131** M

Algemeen

Orig. nr. S131GH

Vermogen

Spanning V 1x230

Vermogen motor kW 1,1

Afmetingen

Zaagsnelheid m/min 22-31-55

Afmetingen zaaglint (l x b x d) mm 1638x13x0,65

Gewicht kg 78,00

Afmetingen (l x b x h) mm 1050 x 450 x 550

Prijs € **749,00**

ZAAGBLADEN

p. 1156



ZAAGCAPACITEIT			
	0°	45°	60°
	Ø 150 mm	Ø 105 mm	Ø 65 mm
	150 x 160 mm	105 x 190 mm	65 x 65 mm



- Zaagbandgeleiding met kogellagers
- Snelspan Schroef
- Vario aandrijving
- Koelpomp
- Inclusief mobiele sokkel

Eenvoudige en stevige bandzaagmachine met onder verstek instelbare zaagbeugel 0° tot 60°.

Troeven:

- Regelbare zaagsnelheden van 22 tot 65 m/min
- Onder hoek verstelbaar 0° tot 60°
- Krachtige en stille motor 1,1 kW
- Directe, instelbare koeling op het zaagblad
- Snelspanklemming

Geschikt voor:

- Het zagen van buizen en profielen van staal en roestvrij staal

Kenmerken:

- Stabiele gietijzeren uitvoering.
- Drukknop in de hendel voor het activeren en stoppen van de zaag.
- Voet, draaiarm en zaagbeugel is vervaardigd uit grijs gietijzer.
- Kogelgelageerde zaagbladgeleiding.
- Met ingebouwde koelpomp in de voet.
- Ergonomisch en gebruiksvriendelijk bedieningspaneel met aparte noodstop, schakelaar voor de koelpomp en potentiometer voor de variabele toerental.

Veiligheden:

- Gebruikersvriendelijke veiligheidsschakelaar met laagspanningsbeveiliging en motorbeveiliging.
- Aparte noodstop, aparte start en stopknop.

Standaard geleverd met

- Sokkel,
- Koelpomp
- Bi-metalen zaagblad
- Materiaalaanslag.
- Nederlandstalige handleiding, opschriften, CE - kenmerk, en CE-attest volgens Machine richtlijn 2006/42/CE, Laagspanningsrichtlijn 2006/95/CE en EMC Richtlijn 2004/108/CE



Aparte startknop, aparte stopknop, aparte noodstop, schakelaar koelpomp, potentiometer Vario drive 20-62 m/min

Order nr.	713300150	
Algemeen		
Orig. nr.	S150G VARIO	
Vermogen		
Spanning	V	1x230
Vermogen motor	kW	1,1
Vermogen motor koelpomp	W	50
Afmetingen		
Zaagsnelheid	m/min	20-65
Afmetingen zaaglint (l x h x d)	mm	1735x13x0,90
Opheffen zaagbeugel		manueel
Lengte met gesloten spanklem	mm	930
Lengte met geopende spanklem	mm	1.120
Breedte zonder materiaalaanslag	mm	510
Breedte met materiaalaanslag	mm	720
Hoogte onderste eindpositie zaagbeugel	mm	1.240
Hoogte bovenste eindpositie zaagbeugel	mm	1.590
Gewicht	kg	100,00
Afmetingen (l x b x h)	mm	1130 x 570 x 840
Prijs	€	1.069,00



Stationaire, robuuste bandzaagmachine onder hoek verstelbaar met 1 of 2 zaagsnelheden.

Troeven:

- Tandwieloverbrenging
- Daalvoeding door traploos regelbare hydraulische cilinder
- Onder hoek verstelbaar 0° tot 45°
- Snelspanklemming
- Koelvloeistofsysteem met koelpomp

Geschikt voor:

- Werkplaatsen, onderhoudsdiensten, opleidingcentra en scholen

Kenmerken:

- Met 1 zaagsnelheid 68 m/min (1 x 230 V)
- Met 2 instelbare zaagsnelheden 40 / 80 m/min (3x400 V)
- Grote zaagcapaciteit door zaagbeugel en groot gedimensioneerde loopwielen
- Zagen onder verstek mogelijk dankzij het in het verstek plaatsen van de zaagbeugel van 0° tot 45°
- Stabiele gietijzeren spanklem met snelspan klemming
- Robuuste machineonderstel garandeert stabiliteit
- Precisie afwerking volgens Optimum normen
- Automatische afslag na het einde van de zaagcyclus
- Krachtige terughaalveer
- 5-punts kogelgelageerde zaagbladgeleiding
- Directe, instelbare koeling op het zaagblad
- Met ingebouwde koelpomp
- Krachtige en stille motor
- Zaagborstel voor het reinigen van het zaagblad
- Andere voltages: 3 x 220 V en 3 x 440 V op aanvraag

Veiligheden:

- Ergonomisch bedieningspaneel met aparte noodstop, aparte start en stopknop
- Nullastspanning
- Veiligheidsschakelaar in de zaagbeugel

Order nr.	713300212	713300210
Algemeen		
Orig. nr.	S210G-230V	S210G-400V
Vermogen		
Spanning	V	1x230
Vermogen motor	kW	0,75
Vermogen motor koelpomp	W	40
Afmetingen		
Zaagsnelheid	m/min	68
Afmetingen zaaglint (l x h x d)	mm	2080x20x0,90
Opheffen zaagbeugel		manueel
Lengte met gesloten spanklem	mm	1.200
Lengte met geopende spanklem	mm	1.310
Breedte zonder materiaalaanslag	mm	510
Breedte met materiaalaanslag	mm	685
Hoogte onderste eindpositie zaagbeugel	mm	1.300
Hoogte bovenste eindpositie zaagbeugel	mm	1.700
Gewicht	kg	160,00
Afmetingen (l x b x h)	mm	1300 x 580 x 900
Prijs	€	1.795,00
		1.789,00

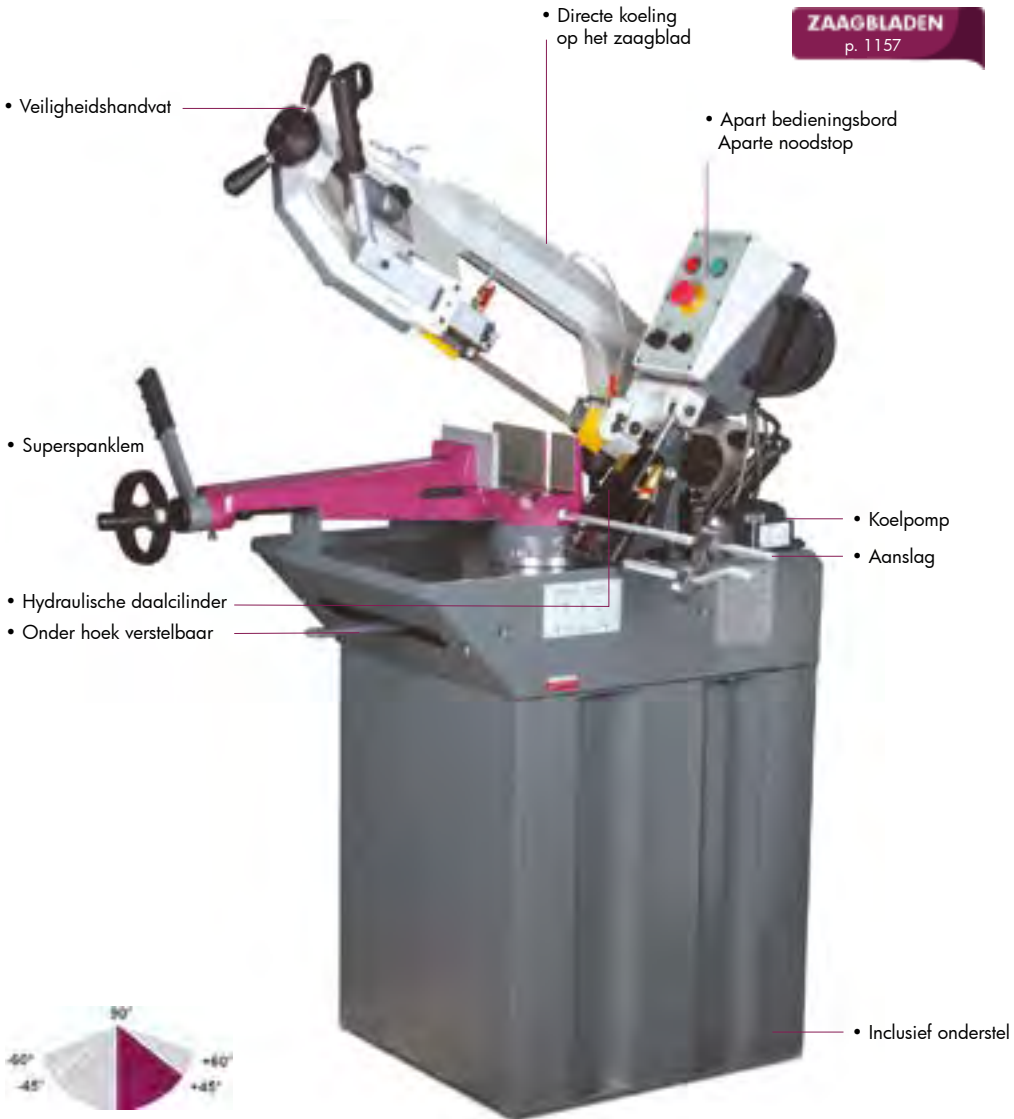

ZAAGBLADEN
p. 1157

MACHINES



ZAAGCAPACITEIT

	0°	45°
	Ø 170 mm	Ø 125 mm
	190 x 140 mm	95 x 140 mm

Standaard geleverd met:

- Sokkel
- Koelpomp
- Bi-metalen zaagblad
- Materiaalaanslag
- Nederlandstalige handleiding, opschriften, CE - kenmerk, en CE-attest volgens Machine richtlijn 2006/42/CE, Laagspanningsrichtlijn 2006/95/CE en EMC Richtlijn 2004/108/CE



Mobiele, robuuste bandzaagmachine met tandwieloverbrenging met traploos regelbare zaagdruk.

Troeven:

- Grote zaagcapaciteiten
- Tandwieloverbrenging met 3 instelbare zaagsnelheden 39 / 66 / 82 m/min
- Daalvoeding door traploos regelbare hydraulische cilinder
- Onder hoek verstelbaar 0° tot 45°
- Met ingebouwde koelpomp in de voet
- Met handvat en wielen om eenvoudig te transporteren

Geschikt voor:

- Bouwwerven, service wagens

Kenmerken:

- Groot gedimensioneerde loopwielen
- Zagen onder verstek mogelijk dank zij het in het verstek plaatsen van de klem van 0° tot 45°
- Stabiele gietijzeren uitvoering
- Precisie afwerking volgens Optimum normen
- Automatische afslag na het einde van de zaagcyclus
- Krachtige terughaalveer
- Krachtige en stille motor 0,75 kW
- Zaagborstel voor het reinigen van het zaagblad
- Zaagbandgeleiding: 5-punts kogelgelagerde geleiding, uitstekende bandloop met optimale zaagsnede
- Koelmiddelrichting in onderstel geïntegreerd, inhoud 11 liter, directe, instelbare koeling op het zaagblad
- Zowel in 1 x 230 V als 3 x 400 V leverbaar

Order nr.		713300186	713300182
Algemeen			
Orig. nr.		S181G-230V	S181G-400V
Vermogen			
Spanning	V	1x230	3x400
Vermogen motor	kW	0,75	0,75
Vermogen motor koelpomp	W	50	50
Afmetingen			
Zaagsnelheid	m/min	39/66/82	39/66/82
Afmetingen zaaglint (l x h x d)	mm	2362x19x0,90	2362x19x0,90
Opheffen zaagbeugel		manueel	manueel
Lengte met geopende spanklem	mm	1.200	1.200
Breedte zonder materiaalaanslag	mm	450	450
Breedte met materiaalaanslag	mm	720	720
Hoogte onderste eindpositie zaagbeugel	mm	1.050	1.050
Hoogte bovenste eindpositie zaagbeugel	mm	1.600	1.600
Gewicht	kg	130,00	130,00
Afmetingen (l x b x h)	mm	1300 x 460 x 1118	1300 x 460 x 1118
Prijs	€	1.315,00	1.389,00



koelmiddelrichting



snelspan machineklem



3 zaagsnelheden

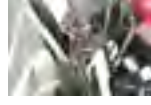

zaagbandgeleiding

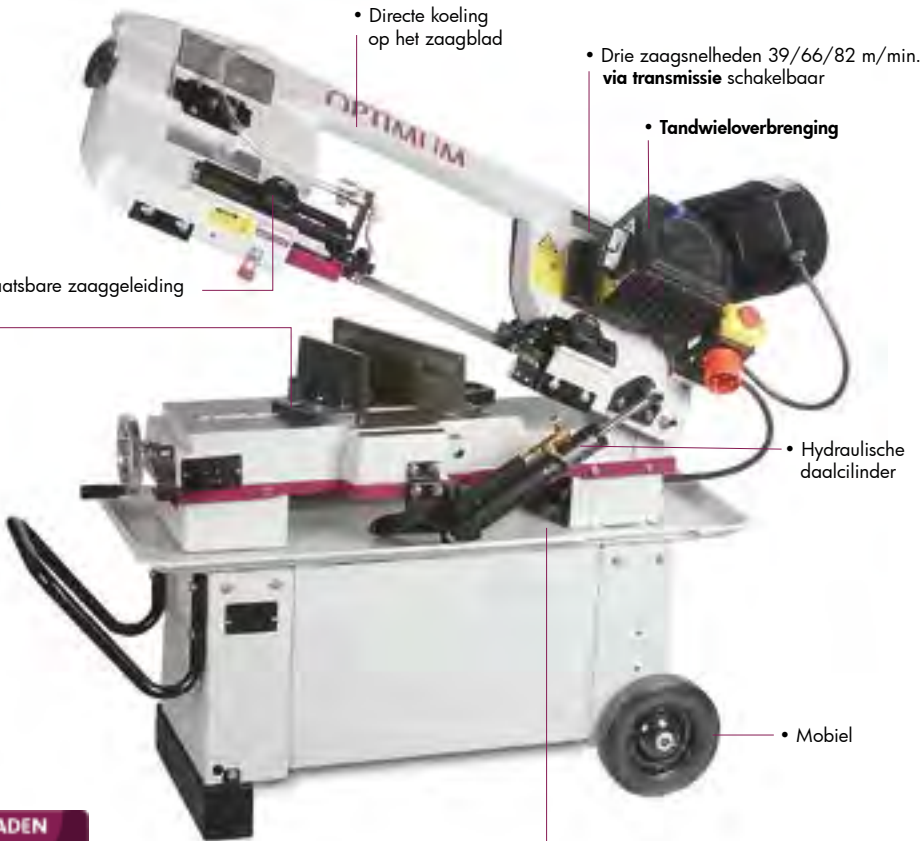

• Verplaatsbare zaaggeleiding

• Directe koeling op het zaagblad

• Drie zaagsnelheden 39/66/82 m/min. via transmissie schakelbaar

• Tandwieloverbrenging

• Hydraulische daalcilinder

• Mobiel

0,75KW

ZAAGBLADEN

p. 1157



ZAAGCAPACITEIT

30°		Ø 100 mm	180 x 340 mm
45°		Ø 110 mm	60 x 300 mm
60°		Ø 110 mm	130 x 130 mm



• Met hydraulische tegendrukcilinder voor traploos instelbare dalingsnelheid.

Standaard geleverd met:

- Mobiele sokkel
- Koelpomp
- Bi-metalen zaagblad
- Materiaalaanslag
- Nederlandstalige handleiding, opschriften, CE - kenmerk, en CE-attest volgens Machine richtlijn 2006/42/CE, Laagspanningsrichtlijn 2006/95/CE en EMC Richtlijn 2004/108/CE



Stationaire, robuuste bandzaagmachine, onder hoek verstelbaar tot 60°, en verkrijgbaar met 2 zaagsnelheden (400 V) of in Vario uitvoering (230 V)

Troeven:

- Met versterkte zaagbeugel
- Zaagbladhoogte 27 mm
- Onder hoek verstelbaar tot 60°
- Daalvoeding door traploos regelbare hydraulische cilinder
- Koelsysteem met koelpomp

Geschikt voor:

- Iedere werkplaats, montagebedrijven, onderhoudsdienst, scholen en opleidingcentra, algemene industrie

Kenmerken:

- Beste prijs-kwaliteitsverhouding voor zaagmachine met zaagblad hoogte 27 mm
- Met 2 instelbare zaagsnelheden 45 / 90 m/min (3x400V)
- Variabele zaagsnelheden 20 – 90 m/min (Vario op 1x230V)
- Grote zaagcapaciteit door zaagbeugel en groot gedimensioneerde loopwielen
- Zaagvoeding door traploos regelbare hydraulische cilinder
- Zagen onder verstek mogelijk dankzij het in het verstek plaatsen van de zaagbeugel van 0° tot 60°
- Stabiele gietijzeren spanklem met snelspan klemming
- Zaagbladspanning duidelijk afleesbaar door geïnstalleerde manometer
- Robuuste machineonderstel garandeert stabiliteit
- Ergonomische geplaatst bedieningsbord met aparte noodstop, , aparte start-stopknop, koelmiddelschakelaar en keuzeschakelaar twee snelheden of potentiometer (enkel Vario modellen)
- Precisie afwerking volgens Optimum normen
- Automatische afslag na het einde van de zaagcyclus
- Krachtige terughaalveer
- 5-punts kogelgelageerde zaagbladgeleiding
- Directe, instelbare koeling op het zaagblad
- Met ingebouwde koelpomp
- Krachtige en stille motor
- Zaagborstel voor het reinigen van het zaagblad
- Andere voltages: 3x220V en 3x440V op aanvraag

Veiligheden:

- Ergonomisch bedieningspaneel met aparte noodstop, aparte start en stopknop
- Nullastspanning
- Veiligheidsschakelaar in de zaagbeugel

Order nr.	713300260 ^M	713300265 ^M
Algemeen		
Orig. nr.	S275N 400V	S275NV 230V
Vermogen		
Spanning	V	3x400
Vermogen motor	kW	1.1
Vermogen motor koelpomp	W	50
Afmetingen		
Zaagsnelheid	m/min	45-90
Afmetingen zaaglint (l x h x d)	mm	2480x27x0.9
Opheffen-dalen zaagbeugel		Manueel-hydraulisch
Openen-sluiten spanklem		Manueel
Lengte met gesloten spanklem	mm	1400
Lengte met geopende spanklem	mm	1700
Werkhoogte	mm	910
Breedte zonder materiaalaanslag	mm	530
Breedte met materiaalaanslag	mm	985
Hoogte onderste eindpositie zaagbeugel	mm	1360
Hoogte bovenste eindpositie zaagbeugel	mm	1700
Gewicht	kg	185,00
Afmetingen (l x b x h)	mm	1360 x 580 x 880
Prijs	€	1.899,00
		2.049,00



- Inclusief manometer



- Snelpanschroef

- Zaagbladhoogte 27mm

- Apart bedieningsbord

- Onder hoek verstelbaar

- Hydraulische daalcilinder

ZAAGBLADEN

p. 1158



ZAAGCAPACITEIT

45°	Ø 125 mm	100 x 100 mm
45°	Ø 150 mm	100 x 100 mm
45°	Ø 150 mm	100 x 100 mm

Standaard geleverd met

- Sokkel
- Koelpomp
- Bi-metalen zaagblad
- Materiaalaanslag
- Nederlandstalige handleiding, opschriften, CE - kenmerk, en CE-attest volgens Machine richtlijn 2006/42/CE, Laagspanningsrichtlijn 2006/95/CE en EMC Richtlijn 2004/108/CE



Stationaire, robuuste bandzaagmachine, onder hoek verstelbaar tot 60°, met variabele zaagsnelheden 20 - 90 m/min 400 V.

Troeven:

- Zaagbladhoogte 27 mm
- Variabele zaagsnelheden 20-90 m/min 400 V
- Zaaggeleidingen voorzien van hardmetalen plaatjes
- Onder hoek verstelbaar tot 60°
- Daalvoeding door traploos regelbare hydraulische cilinder
- Koelsysteem met koelpomp

Geschikt voor:

- Iedere werkplaats, montagebedrijven, onderhoudsdienst, scholen en opleidingcentra, algemene industrie

Kenmerken:

- Grote zaagcapaciteit door zaagbeugel en groot gedimensioneerde loopwielen
- Zaagvoeding door traploos regelbare hydraulische cilinder
- Zagen onder verstek mogelijk dank zij het in het verstek plaatsen van de zaagbeugel van 0° tot 60°.
- Stabiele gietijzeren spanklem met snelspan klemming
- Zaagbladspanning duidelijk afleesbaar door geïnstalleerde manometer
- Robuuste machineonderstel garandeert stabiliteit
- Ergonomische geplaatst bedieningsbord met aparte noodstop, , aparte start-stopknop, koelmiddelschakelaar en potentiometer
- Precisie afwerking volgens Optimum normen
- Automatische afslag na het einde van de zaagcyclus
- Krachtige terughaalveer
- 5-punts kogelgelageerde zaagbladgeleiding
- Directe, instelbare koeling op het zaagblad
- Met ingebouwde koelpomp
- Krachtige en stille motor
- Zaagborstel voor het reinigen van het zaagblad

Veiligheden:

- Ergonomisch bedieningspaneel met aparte noodstop, aparte start en stopknop
- Nullastspanning
- Veiligheidsschakelaar in de zaagbeugel

Order nr.	713300280	
Algemeen		
Orig. nr.	SD280V 400V	
Vermogen		
Spanning	V	3x400
Vermogen motor	kW	1.5
Vermogen motor koelpomp	W	100
Afmetingen		
Zaagsnelheid	m/min	20 - 90
Afmetingen zaaglint (l x h x d)	mm	2480x27x0.9
Opheffen zaagbeugel		Manueel
Lengte met gesloten spanklem	mm	1400
Lengte met geopende spanklem	mm	1700
Werkhoogte	mm	910
Breedte zonder materiaalaanslag	mm	685
Breedte met materiaalaanslag	mm	985
Hoogte onderste eindpositie zaagbeugel	mm	1300
Hoogte bovenste eindpositie zaagbeugel	mm	1700
Gewicht	kg	185,00
Afmetingen (l x b x h)	mm	1360 x 580 x 880
Prijs	€	2.890,00

SD280V

VARIO

NEW



• Manometer

• Potentiometer

• Vergrendelbare
hoofdschakelaar

• Zaaggeleiding met
hardmetalen plaatjes

• Koelpomp

• Snelpanschroef

• Onder hoek verstelbaar

• Hydraulische
daalcilinder

ZAAGBLADEN

p. 1158



ZAAGCAPACITEIT

45°		Ø 100 mm		100 x 100 mm
45°		Ø 150 mm		150 x 150 mm
60°		Ø 200 mm		200 x 200 mm

Standaard geleverd met

- Sokkel
- Koelpomp
- Bi-metalen zaagblad
- Materiaalaanslag
- Nederlandstalige handleiding, opschriften, CE - kenmerk, en CE-attest volgens Machine richtlijn 2006/42/CE, Laagspanningsrichtlijn 2006/95/CE en EMC Richtlijn 2004/108/CE



Stationaire, robuuste bandzaagmachine onder dubbel verstek van -45° tot $+60^\circ$ met 2 zaagsnelheden.

Troeven:

- Zaagbladhoogte 27 mm
- Onder dubbel verstek van -45° tot $+60^\circ$
- Daalvoeding door traploos regelbare hydraulische cilinder
- Koelsysteem met koelpomp

Geschikt voor:

- Iedere werkplaats, montagebedrijven, onderhoudsdienst, scholen en opleidingcentra, algemene industrie

Kenmerken:

- Met 2 instelbare zaagsnelheden 45 / 90 m/min (3 x 400 V)
- Grote zaagcapaciteit door zaagbeugel en groot gedimensioneerde loopwielen
- Zagen onder verstek mogelijk dankzij het in het verstek plaatsen van de zaagbeugel van -45° tot $+60^\circ$
- Stabiele gietijzeren spanklem met snelspan klemming
- Zaagbladspanning duidelijk afleesbaar door geïnstalleerde manometer
- Robuuste machineonderstel garandeert stabiliteit
- Ergonomische geplaatst bedieningsbord met aparte noodstop, , aparte start-stopknop, koelmiddelschakelaar en keuzeschakelaar twee snelheden
- Precisie afwerking volgens Optimum normen
- Automatische afslag na het einde van de zaagcyclus
- Krachtige terughaalveer
- 5-punts kogelgelageerde zaagbladgeleiding
- Directe, instelbare koeling op het zaagblad
- Met ingebouwde koelpomp
- Krachtige en stille motor
- Andere voltages: 3 x 220 V en 3 x 440 V op aanvraag

Veiligheden:

- Ergonomisch bedieningspaneel met aparte noodstop, aparte start en stopknop
- Nullastspanning
- Veiligheidsschakelaar in de zaagbeugel

Order nr.	713300285	
Algemeen		
Orig. nr.	S285DG	
Vermogen		
Spanning	V	3x400
Vermogen motor	kW	1,1
Vermogen motor koelpomp	W	100
Afmetingen		
Zaagsnelheid	m/min	45/90
Afmetingen zaaglint (l x h x d)	mm	2480x27x0,90
Ophelven zaagbeugel		manueel
Lengte met gesloten spanklem	mm	1.400
Lengte met geopende spanklem	mm	1.700
Breedte zonder materiaalaanslag	mm	870
Breedte met materiaalaanslag	mm	1.270
Hoogte onderste eindpositie zaagbeugel	mm	1.280
Hoogte bovenste eindpositie zaagbeugel	mm	1.800
Gewicht	kg	295,00
Afmetingen (l x b x h)	mm	1460 x 730 x 1060
Prijs	€	2.995,00

S285DG



- Inclusief manometer
- Aparte startknop
- Aparte stopknop
- Aparte noodstop
- Schakelaar koelpomp
- 2 snelheden schakelaarmotor

- Regelbare
daalvoeding bij
het bedieningspaneel



- Koelpomp

- Ondersteuningsrol

- Dubbel verstek

- Aanslag

ZAAGBLADEN p. 1158



ZAAGCAPACITEIT

	0°	60°
⊘	∅ 200 mm	∅ 90 mm
⊞	245 x 150 mm	90 x 110 mm
	-45°	-45°
⊘	∅ 130 mm	∅ 150 mm
⊞	100 x 140 mm	145 x 215 mm

Standaard geleverd met

- Sokkel
- Koelpomp
- Bi-metalen zaagblad
- Materiaalaanslag
- Nederlandstalige handleiding, opschriften, CE - kenmerk, en CE-attest volgens Machine richtlijn 2006/42/CE, Laagspanningsrichtlijn 2006/95/CE en EMC Richtlijn 2004/108/CE



Manuele bandzaagmachine met hydraulische daalcilinder en dubbel verstek -60° tot +45°.

Troeven:

- Zaaggeleiding met hardmetalen plaatjes
- Onder dubbel verstek -60° tot +45°
- Draaitafel met meedraaiende zaagbeugel
- Hydraulische daalcilinder
- Gesloten koelsysteem met directe koeling op het zaagblad
- Europese kwaliteit

Geschikt voor:

- Onderhoudswerkplaatsen, staalbouw, scholen en opleidingcentra, iedere metaal werkplaats die net dat ietsje meer wil

Kenmerken

- Krachtige tweesnelheidsmotor met overbelastingsbeveiliging
- Sterk geribde zaagbeugel en onder 25° geplaatst
- Groot gedimensioneerde tandwielkast met helicoïdale tandwielen
- Spanschroef met snelspanklemming
- Uiterst robuuste onderbouw
- Automatische afslag na zaagcyclus
- Krachtige terughaalveer
- Machineklem verplaatsbaar van links naar rechts
- Zaagbladspanning met ingebouwde schakelaar om de zaag correct op te spannen

Veiligheden:

- Vergrendelbare hoofdschakelaar
- Aparte noodstop, aparte start en stopknop
- Motorbeveiliging
- Lage voltage bediening 24V

H staat voor hydraulische daalcilinder

DG staat voor dubbel verstek

Order nr.	713680013 ⓘ
Algemeen	
Orig. nr.	BMBS230X280 H-DG
Vermogen	
Spanning	V 3x400
Vermogen motor	kW 1.4 / 2.0
Afmetingen	
Zaagsnelheid	m/min 35 / 70
Afmetingen zaaglint (l x h x d)	mm 2720 x 27 x 0,9
Werkhoogte	mm 785
Gewicht	kg 280,00
Afmetingen (l x b x h)	mm 1650 x 885 x 1860

BMBS230X280 H-DG



• 25° geneigde zaagbeugel

• Gesloten koelvloeistof systeem

• Zaaggeleiding met hardmetalen plaatjes

• Variabele drukregeling

• Snelspanklem

• Draaitafel met meedraaiende zaagbeugel

ZAAGBLADEN

p. 1159



SNIJCAPACITEIT

	90°	45°	30°	45°	90°
	270	180	120	180	X
	140°	140°	80°	210°	-
$a < c$	180 x 180	180 x 175	120 x 150	180 x 150	240 x 120
$a > c$	200 x 230	270 x 190	120 x 90	225 x 210	200 x 120

Geleverd met:

- M42 zaagblad 2720x27x0,9 mm
- Materiaalaanslag
- Koelpomp
- Bedieningsleutels
- Nederlandstalige handleiding, opschriften, CE-kenmerk, en CE attest volgens Machine Richtlijn 2006/42/CE, Laagspanningsrichtlijn 2006/95/CE en EMC richtlijn 2004/108/CE

MACHINES



Halfautomatische bandzaagmachine BMBS230x280 HA-DG-F met dubbel verstek -60° tot +45° en frequentieregelaar 20-100 m/min

Troeven:

- Zaaggeleiding met hardmetalen plaatjes
- Dubbel verstek -60° tot +45°
- **Halfautomatische uitvoering:**
 - Sluiten machineklem
 - Dalen zaagbeugel
 - Stijgen zaagbeugel
 - Openen machineklem
- Met frequentieomvormer voor variabele zaagsnelheden van 20 - 100 m/min
- Europese kwaliteit

Geschikt voor:

- Industrie, onderhoudswerkplaatsen, staalbouw, scholen en opleidingcentra, iedere metaal werkplaats die net dat ietsje meer wil

Kenmerken:

- Met hydraulisch gestuurde zaagfuncties
- Kogelgelagerde draaitafel met meedraaiende zaagbeugel
- Sterk geribde zaagbeugel en onder 25° geplaatst
- Groot gedimensioneerde tandwielkast met helicoïdale tandwielen
- Hydraulische machineklem met manuele snelspanklemming
- Verplaatsbaar bedieningsbord
- Uiterst robuuste onderbouw
- Gesloten koelsysteem met directe koeling op het zaagblad
- Machineklem verplaatsbaar van links naar rechts
- Zaagbladspanning met ingebouwde schakelaar om de zaag correct op te spannen

Veiligheden:

- Vergrendelbare hoofdschakelaar
- Aparte noodstop, aparte start en stopknop
- Motorbeveiliging
- Lage voltage bediening 24 V

HA staat voor halfautomatische uitvoering

DG staat voor dubbel verstek

F staat voor frequentieregeling - variabele zaagsnelheden

Order nr.	713690026 *	
Algemeen		
Orig. nr.	BMBS230X280 HA-DG-F	
Vermogen		
Spanning	V	3x400
Vermogen motor	kW	1.5
Afmetingen		
Zaagsnelheid	m/min	20-100
Afmetingen zaaglint (l x h x d)	mm	2720x27x0.9
Opheffen-dalen zaagbeugel	Hydraulisch	
Openen-sluiten spanklem	Hydraulisch	
Werkhoogte	mm	795
Gewicht	kg	395,00
Afmetingen (l x b x h)	mm	1860 x 1045 x 1750

BMBS230X280 HA-DG F

NEW

HA

VARIO

MADE IN EUROPE



• Zaagbladspanning met ingebouwde schakelaar

• Zaagbreukbeveiliging

• Directe koelvloeistof-toevoer

• Voeler voor zaaghoogteinstelling

• Zaaggeleiding met hardmetalen plaatjes

• Hydraulische machineklem

• Tandwielkast met helicoïdale tandwielen

• Draaitafel

• Verplaatsbaar bedieningsbord

ZAAGBLADEN

p. 1159



SNIJCAPACITEIT

	Staal	Alu	Coer	Zijer	Staal	Alu	Staal
⊙	230	185	125	185	+	+	+
●	230*	180*	120*	180*	+	+	+
⊞	280-180	180-170	120-130	180-120	+	+	180-120



- Stukenteller
- Zaagbreuk
- Zaagsnelheid
- Positie zaagarm

Geleverd met:

- M42 zaagblad 2720 x 27 x 0,9 mm
- Materiaalaanslag
- Koelpomp
- Bedieningsleutels
- Nederlandstalige handleiding, opschriften, CE-kenmerk, en CE attest volgens Machine Richtlijn 2006/42/CE, Laagspanningsrichtlijn 2006/95/CE en EMC richtlijn 2004/108/CE



Stationaire, robuuste bandzaagmachine onder dubbel verstek van -45° tot $+60^\circ$ met 2 zaagsnelheden of variabele zaagsnelheden 20 – 90 m/min .

Troeven:

- Zaagbladhoogte 27 mm
- Onder dubbel verstek -45° tot $+60^\circ$
- Regelbare daalvoeding in paneel
- Koelsysteem met koelpomp

Geschikt voor:

- Iedere werkplaats, montagebedrijven, onderhoudsdiensten, scholen en opleidingcentra, algemene industrie

Kenmerken:

- Met 2 instelbare zaagsnelheden 35 / 70 m/min
- Met variabele zaagsnelheden 20 – 90 m/min (Vario model)
- Grote zaagcapaciteit door zaagbeugel en groot gedimensioneerde loopwielen
- Zagen onder verstek mogelijk dankzij het in het verstek plaatsen van de zaagbeugel van -45° tot $+60^\circ$
- Stabiele gietijzeren spanklem met snelspan klemming
- Zaagbladsparing duidelijk afleesbaar door geïnstalleerde manometer
- Robuuste machineonderstel garandeert stabiliteit
- Aan de linkerzijde geïnstalleerde ondersteuningsrol, voor het ondersteunen van langere werkstukken
- Ergonomische geplaatst bedieningsbord met aparte noodstop, , aparte start-stopknop, koelmiddelschakelaar en keuzeschakelaar twee snelheden of potentiometer (enkel Vario modellen), keuzeschakelaar (manueel of in cyclus)
- Precisie afwerking volgens Optimum normen
- Automatische afslag na het einde van de zaagcyclus
- Krachtige terughaalveer
- 5-punts kogelgelageerde zaagbladgeleiding
- Directe, instelbare koeling op het zaagblad
- Met ingebouwde koelpomp
- Krachtige en stille motor
- Voorzien van een zaagborstel voor het reinigen van het zaagblad
- Andere voltages: 3 x 220 V en 3 x 440 V op aanvraag

Veiligheden:

- Ergonomisch bedieningspaneel met aparte noodstop, aparte start en stopknop
- Nullastspanning
- Tweede noodstop
- Veiligheidsschakelaar in de zaagbeugel
- Vergrendelbare hoofdschakelaar

Order nr.	713290290	713290295
Algemeen		
Orig. nr.	S300DG	S300DG VARIO
Vermogen		
Spanning	V	3x400
Vermogen motor	kW	1,5
Vermogen motor koelpomp	W	100
Afmetingen		
Zaagsnelheid	m/min	35/70
Afmetingen zaaglint (l x h x d)	mm	2750x27x0,9
Opheffen zaagbeugel		manueel
Lengte met gesloten spanklem	mm	1.400
Lengte met geopende spanklem	mm	1.700
Breedte zonder materiaalaanslag	mm	700
Breedte met materiaalaanslag	mm	1.300
Hoogte onderste eindpositie zaagbeugel	mm	1.600
Hoogte bovenste eindpositie zaagbeugel	mm	1.850
Gewicht	kg	335,00
Afmetingen (l x b x h)	mm	1720 x 730 x 1130
Prijs	€	3.699,00
		4.119,00



• Snelspanklem

• Vergrendbare hoofdschakelaar

• Aparte noodstop

• Aparte noodstop



• Koelpomp

• Links / rechts onder hoek verstelbaar

• Regelbare daalvoeding in bedieningspaneel

ZAAGBLADEN

p. 1159



	0°	-45°	+45°	-20°
Ø	Ø 206 mm	Ø 220 mm	Ø 135 mm	Ø 215 mm
h	190 mm	190 mm	120 mm	190 mm
l	310 x 190 mm	190 x 135 mm	135 x 135 mm	190 x 200 mm

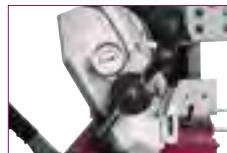

• Inclusief manometer



Standaard geleverd met:

- Sokkel
- Koelpomp
- Bi-metalen zaagblad
- Materiaalaanslag 500 mm met mm schaalverdeling
- Spanen opvangbak
- Nederlandstalige handleiding, opschriften, CE - kenmerk, en CE-attest volgens Machine richtlijn 2006/42/CE, Laagspanningsrichtlijn 2006/95/CE en EMC Richtlijn 2004/108/CE



Stationaire, robuuste bandzaagmachine met draaitafel onder dubbel verstek van -45° tot $+60^\circ$ met variabele zaagsnelheden 20 – 90 m/min.

Troeven:

- Zaagbladhoogte 27 mm
- Variabele zaagsnelheden 20 – 90 m/min
- Onder dubbel verstek -45° tot $+60^\circ$
- Degelijke gradenboog met grote schaalverdeling
- Regelbare daalvoeding in paneel
- Koelsysteem met koelpomp

Geschikt voor:

- Iedere werkplaats, montagebedrijven, onderhoudsdiensten, scholen en opleidingscentra, algemene industrie

Kenmerken:

- Grote zaagcapaciteit door zaagbeugel en groot gedimensioneerde loopwielen
- Zagen onder verstek mogelijk dankzij het in het verstek plaatsen van de zaagbeugel van -45° tot $+60^\circ$
- Stabiele gietijzeren spanklem met snelspan klemming
- Zaagbladspanning duidelijk afleesbaar door geïnstalleerde manometer
- Robuuste machineonderstel garandeert stabiliteit
- Aan de linkerzijde geïnstalleerde ondersteuningsrol, voor het ondersteunen van langere werkstukken
- Ergonomische geplaatst bedieningsbord met aparte noodstop, aparte start-stopknop, koelmiddelschakelaar en keuzeschakelaar twee snelheden of potentiometer (enkel Vario modellen), keuzeschakelaar (manueel of in cyclus)
- Precisie afwerking volgens Optimum normen
- Automatische afslag na het einde van de zaagcyclus
- Krachtige terughaalveer
- 5-punts kogelgelageerde zaagbladgeleiding
- Directe, instelbare koeling op het zaagblad
- Met ingebouwde koelpomp
- Krachtige en stille motor
- Voorzien van een zaagborstel voor het reinigen van het zaagblad
- Andere voltages: 3 x 220 V en 3 x 440 V op aanvraag

Veiligheden:

- Ergonomisch bedieningspaneel met aparte noodstop, aparte start en stopknop
- Nullastspanning
- Tweede noodstop
- Veiligheidsschakelaar in de zaagbeugel
- Vergrendelbare hoofdschakelaar

Order nr.	713290335	
Algemeen		
Orig. nr.	S310DG VARIO	
Vermogen		
Spanning	V	3x400
Vermogen motor	kW	1,5
Vermogen motor koelpomp	W	100
Afmetingen		
Zaagsnelheid	m/min	20-90
Afmetingen zaaglint (l x h x d)	mm	2750x27x0,9
Opheffen zaagbeugel		manueel
Lengte met gesloten spanklem	mm	1.400
Lengte met geopende spanklem	mm	1.680
Breedte zonder materiaalaanslag	mm	700
Breedte met materiaalaanslag	mm	1.330
Hoogte onderste eindpositie zaagbeugel	mm	1.600
Hoogte bovenste eindpositie zaagbeugel	mm	2.000
Gewicht	kg	380,00
Afmetingen (l x b x h)	mm	1720 x 730 x 1130
Prijs	€	4.695,00

VARIO

**DUBBEL VERSTEK
(LINKS EN RECHTS)**

S310D



• Inclusief manometer

• Vario

• Regelbare
daalvoeding
in bedieningspaneel

• Koelpomp

ZAAGBLADEN

p. 1159



• Zaagbeugel en
gradenverdeling
verdraaien simultaan



ZAAGCAPACITEIT

	0°	+45°	+60°	-45°
⊘	⊘ 250 mm	⊘ 192 mm	⊘ 110 mm	⊘ 190 mm
⊘	270 mm	140 mm	110 mm	190 mm
⊘	270 x 200 mm	140 x 210 mm	110 x 210 mm	140 x 130 mm

Standaard geleverd met

- Sokkel
- Koelpomp
- Bi-metalen zaagblad
- Materiaalaanslag 500 mm met mm schaalverdeling.
- Spanen opvangbak
- Nederlandstalige handleiding, opschriften, CE - kenmerk, en CE-attest volgens Machine richtlijn 2006/42/CE, Laagspanningsrichtlijn 2006/95/CE en EMC Richtlijn 2004/108/CE

MACHINES



Stationaire, robuuste bandzaagmachine onder dubbel verstek van -45° tot $+60^\circ$ met twee zaagsnelheden.

Troeven:

- Zaagbladhoogte 27 mm
- Onder dubbel verstek -45° tot $+60^\circ$
- Regelbare dalvoeding in paneel
- Koelsysteem met koelpomp

Geschikt voor:

- Iedere werkplaats, montagebedrijven, onderhoudsdienst, scholen en opleidingcentra, algemene industrie

Kenmerken:

- Met 2 zaagsnelheden 36 - 72 m/min dankzij tweesnelheidsmotor
- Zware gietijzeren uitvoering
- Grote zaagcapaciteit door zaagbeugel en groot gedimensioneerde loopwielen
- Zagen onder verstek mogelijk dankzij het in het verstek plaatsen van de zaagbeugel van -45° tot $+60^\circ$.
- Stabiele gietijzeren spanklem met snelspan klemming.
- Zaagbladspanning duidelijk afleesbaar door geïnstalleerde manometer.
- Robuuste machineonderstel garandeert stabiliteit.
- Aan de linkerzijde geïnstalleerde ondersteuningsrol, voor het ondersteunen van langere werkstukken.
- Tweetrapsoverbrenging van de motor voor krachtige overbrenging van het motorvermogen.
- Krachtige en stille motor.
- Ergonomische geplaatst bedieningsbord met aparte noodstop, aparte start-stopknop, koelmiddelschakelaar en keuzeschakelaar twee snelheden, keuzeschakelaar (manueel of in cyclus)
- Precisie afwerking volgens Optimum normen.
- Automatische afslag na het einde van de zaagcyclus.
- Twee krachtige terughaalveren
- 5-punts kogelgelageerde zaagbladgeleiding.
- Directe, instelbare koeling op het zaagblad.
- Met ingebouwde koelpomp.
- Voorzien van een zaagborstel voor het reinigen van het zaagblad
- Andere voltages: 3x220V en 3x440V op aanvraag.

Veiligheden:

- Ergonomisch bedieningspaneel met aparte noodstop, aparte start en stopknop
- Nullastspanning
- Tweede noodstop
- Veiligheidsschakelaar in de zaagbeugel
- Vergrendelbare hoofdschakelaar

Order nr.	713290350	
Algemeen		
Orig. nr.	S350DG	
Vermogen		
Spanning	V	3x400
Vermogen motor	kW	2,2
Vermogen motor koelpomp	W	50
Afmetingen		
Zaagsnelheid	m/min	36/72
Afmetingen zaaglint (l x h x d)	mm	2925x27x0,9
Opheffen zaagbeugel		manueel
Lengte met gesloten spanklem	mm	1.500
Lengte met geopende spanklem	mm	1.750
Breedte zonder materiaalaanslag	mm	1.075
Breedte met materiaalaanslag	mm	1.415
Hoogte onderste eindpositie zaagbeugel	mm	1.420
Hoogte bovenste eindpositie zaagbeugel	mm	1.800
Gewicht	kg	550,00
Afmetingen (l x b x h)	mm	1930 x 970 x 1120
Prijs	€	5.370,00

**DUBBEL VERSTEK
LINKS EN RECHTS**

S350DG



- Inclusief manometer



- Krachtige terughaalveren
- Lengte aanslag
- Koelpomp
- Links / rechts onder hoek verstelbaar
- Regelbare daalvoeding in bedieningspaneel

ZAAGBLADEN

p. 1160



ZAAGCAPACITEIT

Hoek	Ø	W	L	W
45°	125 mm	125 mm	125 mm	125 mm
45°	150 mm	150 mm	150 mm	150 mm
45°	175 mm	175 mm	175 mm	175 mm
45°	200 mm	200 mm	200 mm	200 mm



MACHINES

Standaard geleverd met

- Sokkel
- Koelpomp
- Bi-metalen zaagblad
- Materiaalaanslag 500 mm met mm schaalverdeling.
- Spanenopvangbak
- Nederlandstalige handleiding, opschriften, CE - kenmerk, en CE-attest volgens Machine richtlijn 2006/42/CE, Laagspanningsrichtlijn 2006/95/CE en EMC Richtlijn 2004/108/CE

Stationaire, robuuste halfautomatische bandzaagmachine onder dubbel verstek van -45° tot $+60^\circ$ met variabele zaagsnelheden.

Troeven:

- Dubbel verstek -60° tot $+45^\circ$
- **Halfautomatische uitvoering:**
 - Sluiten machineklem
 - Dalen zaagbeugel
 - Stijgen zaagbeugel
 - Openen machineklem
- Met variabele zaagsnelheden van 0 - 80 m/min
- Koelsysteem met koelpomp

Geschikt voor:

- Iedere werkplaats, montagebedrijven, onderhoudsdienst, scholen en opleidingcentra, algemene industrie

Kenmerken:

- Zware plaatstalen uitvoering
- Grote zaagcapaciteit door zaagbeugel en groot gedimensioneerde loopwielen
- Regelbare dalvoeding in paneel, alsook een tweede noodstop
- Zagen onder verstek mogelijk dankzij het in het verstek plaatsen van de zaagbeugel van -45° tot $+60^\circ$
- Stabiele gietijzeren spanklem met snelspan klemming
- Zaagbladspanning duidelijk afleesbaar door geïnstalleerde manometer
- Robuuste machineonderstel garandeert stabiliteit
- Aan de linkerzijde geïnstalleerde ondersteuningsrol, voor het ondersteunen van langere werkstukken
- Tweektrapoverbrenging van de motor voor krachtige overbrenging van het motorvermogen
- Krachtige en stille motor van 2,2 kW
- Ergonomisch geplaatst bedieningsbord met aparte noodstop, aparte start-stopknop, koelmiddelschakelaar en keuzeschakelaar twee snelheden, keuzeschakelaar (manueel of in cyclus)
- Precisie afwerking volgens Optimum normen
- Automatische afslag na het einde van de zaagcyclus
- Twee krachtige terughaalveren
- 5-punts kogelgelageerde zaagbladgeleiding
- Directe, instelbare koeling op het zaagblad
- Met ingebouwde koelpomp
- Voorzien van een zaagborstel voor het reinigen van het zaagblad

Veiligheden:

- Ergonomisch bedieningspaneel met aparte noodstop, aparte start en stopknop
- Nullastspanning
- Tweede noodstop
- Veiligheidsschakelaar in de zaagbeugel
- Vergrendelbare hoofdschakelaar

Order nr.	713292355	
Algemeen		
Orig. nr.	SD350AV	
Vermogen		
Spanning	V	3x400
Vermogen motor	kW	2.2
Vermogen motor koelpomp	W	50
Vermogen hydraulische motor	W	1400
Afmetingen		
Zaagsnelheid	m/min	0-80
Afmetingen zaaglint (l x h x d)	mm	2925x27x0.9
Opheffen zaagbeugel		hydraulisch/automatisch
Openen-sluiten spanklem		hydraulisch
Lengte met gesloten spanklem	mm	0
Lengte met geopende spanklem	mm	0
Werkhoogte	mm	1000
Minimum restweg in automatische modus	mm	0
Minimum restweg in manuele modus	mm	0
Breedte zonder materiaalaanslag	mm	1075
Breedte met materiaalaanslag	mm	1415
Hoogte onderste eindpositie zaagbeugel	mm	1420
Hoogte bovenste eindpositie zaagbeugel	mm	2000
Maximum lengte	mm	0
Gewicht	kg	600,00
Afmetingen (l x b x h)	mm	1750 x 1075 x 1420
Prijs	€	8.310,00

HA

VARIO

SD350AV



ZAAGBLADEN

p. 1160



ZAAGCAPACITEIT

	0°	45°	60°	45°
⊙	Ø 279 mm	Ø 230 mm	Ø 140 mm	Ø 230 mm
⊥	236 mm	200 mm	140 mm	200 mm
⊞	300 x 330 mm	140 x 200 mm	140 x 230 mm	210 x 230 mm



Standaard geleverd met

- Sokkel
- Koelpomp
- Bi-metalen zaagblad
- Materiaalaanslag 500 mm met mm schaalverdeling.
- Spanenopvangbak
- Nederlandstalige handleiding, opschriften, CE - kenmerk, en CE-attest volgens Machine richtlijn 2006/42/CE, Laagspanningsrichtlijn 2006/95/CE en EMC Richtlijn 2004/108/CE



Manuele bandzaagmachine BMBS300x320 H-DG met dubbel verstek -60° tot +45° en twee zaagsnelheden 35 / 70 m/min.

Troeven:

- Zaaggeleiding met hardmetalen plaatjes
- Onder dubbel verstek -60° tot +45°
- Draaitafel met meedraaiende zaagbeugel
- Hydraulische daalcilinder
- Gesloten koelsysteem met directe koeling op het zaagblad
- Europese kwaliteit

Geslacht voor:

- Onderhoudswerkplaatsen, staalbouw, scholen en opleidingcentra, iedere metaal werkplaats die net dat ietsje meer wil

Kenmerken:

- Krachtige tweesnelheidsmotor met overbelastingsbeveiliging
- Sterk geribde zaagbeugel en onder 25° geplaatst
- Groot gedimensioneerde tandwielkast met helicoïdale tandwielen
- Spanschroef met snelspanklemming
- Uiterst robuuste onderbouw
- Automatische afslag na zaagcyclus
- Krachtige terughalveer
- Machineklem verplaatsbaar van links naar rechts
- Zaagbladspanning met ingebouwde schakelaar om de zaag correct op te spannen

Veiligheden:

- Vergrendelbare hoofdschakelaar
- Aparte noodstop, aparte start en stopknop
- Motorbeveiliging
- Lage voltage bediening 24V

H staat voor hydraulische daalcilinder.

DG staat voor dubbel verstek.

Order nr.	713680012	
Algemeen		
Orig. nr.	BMBS300X320 H-DG	
Vermogen		
Spanning	V	3x400
Vermogen motor	kW	1.4 / 2
Afmetingen		
Zaagsnelheid	m/min	35 / 70
Afmetingen zaaglint (l x h x d)	mm	3660x27x0.9
Ophellen-dalen zaagbeugel	Manueel / hydraul.	
Openen-sluiten spanklem	Manueel	
Werkhoogte	mm	800
Gewicht	kg	548,00
Afmetingen (l x b x h)	mm	2270 x 1170 x 2040

BMBS300X320 H-DG



NEW

• Zaagbladspanning dmv dynamosleutel

• Directe koelvoestof-toevoer

• Snelspanklemming

• Tandwielkast met helicoïdale tandwielen

• Robuuste draaitafel

• Verplaatsbaar bedieningsbord

ZAAGBLADEN
p. 1161



ZAAGCAPACITEIT

	90°	45°	60°	45°	90°
mm	100	500	700	800	4
mm	180°	118°	80°	118°	3
mm	120 x 300	305 x 250	200 x 300	240 x 200	210 x 120

Geleverd met:

- M42 zaagblad 3660x27x0.9
- Materiaalaanslag
- Koelpomp
- Bedieningsleutels
- Nederlandstalige handleiding, opschriften, CE-kenmerk, en CE attest volgens Machine Richtlijn 2006/42/CE, Laagspanningsrichtlijn 2006/95/CE en EMC richtlijn 2004/108/CE

MACHINES



Halfautomatische bandzaagmachine BMBS300x320 HA-DG-F met dubbel verstek -60° tot +45° en frequentieregelaar 20-100 m/min.

Troeven:

- Zaaggeleiding met hardmetalen plaatjes
- Dubbel verstek -60° tot +45°
- **Halfautomatische uitvoering:**
 - Sluiten machineklem
 - Dalen zaagbeugel
 - Stijgen zaagbeugel
 - Openen machineklem
- Met frequentieomvormer voor variabele zaagsnelheden van 20 - 100 m/min
- Europese kwaliteit

Geschikt voor:

- Industrie, onderhoudswerkplaatsen, staalbouw, scholen en opleidingcentra, iedere metaal werkplaats die net dat ietsje meer wil

Kenmerken:

- Met hydraulisch gestuurde zaagfuncties
- Kogelgelagerde draaitafel met meedraaiende zaagbeugel
- Sterk geribde zaagbeugel en onder 25° geplaatst
- Groot gedimensioneerde tandwielkast met helicoidale tandwielen
- Hydraulische machineklem met manuele snelspanklemming
- Verplaatsbaar bedieningsbord
- Uiterst robuuste onderbouw
- Gesloten koelsysteem met directe koeling op het zaagblad
- Machineklem verplaatsbaar van links naar rechts
- Zaagbladspanning met ingebouwde schakelaar om de zaag correct op te spannen

Veiligheden:

- Vergrendelbare hoofdschakelaar
- Aparte noodstop, aparte start en stopknop
- Motorbeveiliging
- Lage voltage bediening 24V

HA staat voor halfautomatische uitvoering

DG staat voor dubbel verstek

F staat voor frequentieregeling - variabele zaagsnelheden

Order nr.	713690041 	
Algemeen		
Orig. nr.	BMBS300X320 HA-DG-F	
Vermogen		
Spanning	V	3x400
Vermogen motor	kW	2.4
Afmetingen		
Zaagsnelheid	m/min	20 - 100
Afmetingen zaaglint (l x h x d)	mm	3660 x 27 x 0.9
Werkhoogte	mm	800
Gewicht	kg	585,00
Afmetingen (l x b x h)	mm	1800 x 950 x 2100

BMBS300X320 HA-DG-F

HA VARIO

NEW



ZAAGBLADEN
p. 1161



ZAAGCAPACITEIT

mm	0°	45°	90°	45°	90°
300	300	200	280	X	
180°	118°	80°	110°	X	
120 x 900	305 x 250	200 x 200	260 x 200	230 x 120	



- Stukenteller
- Zaagbreuk
- Zaagsnelheid
- Positie zaagarm

MACHINES

Geleverd met:

• Microdoseerapparaat (geïnstalleerd)

Voordelen:

- Universeel inzetbaar voor minimale smering
- Afzonderlijke lucht- en sproeimiddelgeleiding, waardoor het niet druipt.
- Met extra grote smeermiddelreservoir, frequentieregelde pomp en sproeikop

• Drukregeling op de spanschroef

- M42 zaagblad 3660x27x0.9
- Materiaalaanslag
- Koelpomp
- Bedieningsleutels
- Nederlandstalige handleiding, opschriften, CE-kenmerk, en CE attest volgens Machine Richtlijn 2006/42/CE, Laagspanningsrichtlijn 2006/95/CE en EMC richtlijn 2004/108/CE



Volautomatische, CNC gestuurde, scharnierende metaal bandzaagmachine met frequentieomvormer, met manuele hoekverstelling tot 60°

Troeven:

- Zaaggeleiding met hardmetalen plaatjes
- Onder verstek tot 60°
- **Automatische CNC uitvoering:**
- Met frequentieomvormer voor variabele zaagsnelheden van 20 - 100 m/min
- Digitale hoekaanduiding
- Europese kwaliteit

Geschikt voor:

- het automatische zagen van RVS en werktuigstaal, profiel, zowel hol als vol materiaal.
- Industrie, onderhoudswerkplaatsen, staalbouw, scholen en opleidingcentra, iedere metaal werkplaats die net dat ietsje meer wil

Kenmerken:

- Bedieningspaneel met modi om zowel halfautomatisch als volautomatisch te werken
- Werkwijze CNC automatische bediening: het is mogelijk verschillende ingaven te programmeren. Het programma houdt per ingave het aantal te zagen stukken en de gewenste zaaglengtes bij. Het aantal stappen van de aanvoerlengtes wordt automatisch berekend door de processor. Het is mogelijk verschillende zaagsneden op te roepen en een programma van verschillende zaagsneden na elkaar te laten uitvoeren. Keuze uit 9 programma's. Bovendien voorzien van volgende informatie weergave: toestand van de zaag, actuele positie van de bewegende machineklem, werkstuk- / zaagsnedenteller, gekozen lengte van de kopzaagsnede. Met TOL kan de instelling van de gewenste tolerantie bekomen worden.
- Automatische bandzaagmachine, hydraulisch gestuurde functies: zakken en stijgen van de zaagbeugel zijn eenvoudig bedienbaar vanaf het bedieningsbord met drukknoppen, alsook het openen en het sluiten van de vaste machineklem, als van de beweegbare machineklem.
- Hydro - dynamische zaagbladspanning afleesbaar via bedieningsbord door indicatielamp
- Zaagarm staat onder 25°, wat een hogere stabiliteit van het zaagblad garandeert.
- Bandzaag met een hoogte van 27 mm: hoe hoger de bandzaag, hoe langer deze het contact behoudt met het te zagen materiaal en hoe rechter de bekomen zaagsnede.
- Zware 2,4 kW motor biedt u genoeg power voor het zwaardere werk met overbelastingsbeveiliging
- Groot gedimensioneerde; oliegesmeerde transmissie.
- Uiterst robuuste bandzaagmachine met dikke plaatstalen onderconstructie (1200 kg)
- Regelbaar koelvloeistofsysteem met directe koeling doorheen beide zaaggeleidingen op de bandzaag.
- Overgedimensioneerde rollagers op beide zaaggeleidingen en dit langs beide zijden van de bandzaag, bovendien uitgerust met grote hardmetalen geleidingsplaatjes; zo wordt de zaag perfect geleid.
- De bandzaag wordt continu gereinigd door een zaagborstel.
- Binnen in de zaagbeugel zitten twee grote loopwielen voorzien van sterke lagers.
- Voorzien van een zaagbreukbeveiliging
- Aanvoerhoogte machineklem 941 mm
- Speciale voeler boven het zaagblad: wanneer het stuk doorgezaagd wordt, blijft de voeler op enkele cm boven het materiaal staan, zo wordt de eindschakelaar van de bovenste positie geactiveerd, zodat men geen tijdsverlies lijdt met het te hoog terugkeren van de zaagbeugel, bovendien moet men deze dan ook niet meer instellen, en komt de bediener niet in de gevarezone.

Veiligheden:

- De kap van de zaagbeugel is uitgerust met een microscharnelaar, bij openen valt de machine stil en bij openen elektrische kast valt de machine eveneens uit. Tevens zijn de zaaggeleidingen afgeschermd.
- Vergrendelbare hoofdscharnelaar, aparte noodstop

Order nr.	713690055 	
Algemeen		
Orig. nr.	BMBS300X320 CNC-G-F	
Vermogen		
Spanning	V	3x400
Vermogen motor	kW	2,4
Afmetingen		
Zaagsnelheid	m/min	20-100
Afmetingen zaaglint (l x h x d)	mm	3660x27x0,9
Minimum restweg in CNC modus	mm	115+20
Gewicht	kg	800,00
Afmetingen (l x b x h)	mm	2240 x 2710 x 2050

BMBS300X320 CNC-G-F



NEW

VARIO

AUTO

CHC

• Mobile machineklem

• Afschermingen volgens CE

• Zaagbreukbeveiliging

• Voeler voor zaaghoogteinstelling

• Verplaatsbaar bedieningsbord

ZAAGBLADEN

p. 1161



ZAAGCAPACITEIT

mm	0°	45°	60°	$\frac{b}{a+b}$
	300	300	200	X
	180*	110*	80*	X
	320 x 300	300 x 250	200 x 200	230 x 120



Geleverd met:

- Zaagblad M42 3660 x 27 x 0,9 mm
- Bedieningsleutels
- Spanenborstel
- Koelpomp
- Nederlandstalige handleiding, opschriften, CE-kenmerk, en CE attest volgens Machine Richtlijn 2006/42/CE, Laagspanningsrichtlijn 2014/35/CE en EMC richtlijn 2014/30/CE



Compleet uitgeruste, budgetvriendelijke halfautomatische lintzaagmachine met grote zaagcapaciteiten, dubbel verstek en variabele zaagsnelheden.

Troeven:

- Zaagbladhoogte 34 mm
- Zaaggeleiding met hardmetalen plaatjes
- Dubbel verstek -60° tot +60°
- **Halfautomatische uitvoering:**
 - Sluiten machineklem
 - Dalen zaagbeugel
 - Stijgen zaagbeugel
 - Openen machineklem
- Met frequentieomvormer voor variabele zaagsnelheden van 20 - 100 m/min
- Digitale weergave hoekverstelling
- Laserlijn
- Uitstekende prijskwaliteitsverhouding

Geschikt voor:

- Het zagen van bouwstalen profielen in moeilijke omstandigheden
- Industrie, onderhoudswerkplaatsen, staalbouw, scholen en opleidingscentra

Kenmerken:

- Halfautomatische bandzaagmachine, hydraulisch gestuurde functies: zakken en stijgen van de zaagbeugel zijn eenvoudig bedienbaar vanaf het bedieningsbord met drukknoppen, alsook het openen en het sluiten van de machineklem
- Zagen onder verstek mogelijk dankzij het in het verstek plaatsen van de zaagbeugel van -60° tot +60°
- Robuust machineonderstel garandeert stabiliteit (1090 kg)
- Zware 3 kW motor biedt u genoeg power voor het zwaardere werk met overbelastingsbeveiliging
- Twee krachtige regelbare ondersteuningsarmen maken dat de zaag recht en onder de correcte spanning blijft staan
- Binnen in de zaagbeugel zitten twee grote loopwielen voorzien van sterke lagers
- Overgedimensioneerde rollagers op beide zaaggeleidingen en dit langs beide zijden van de bandzaag, bovendien uitgerust met grote hardmetalen geleidingsplaatjes; zo wordt de zaag perfect geleid
- De bandzaag wordt continu gereinigd door een zaagborstel
- Ergonomisch geplaatst bedieningspaneel met aparte noodstop en aparte start / stopknop, potentiometer
- Voorzien van zaagbreukbeveiliging
- Manueel zaagbladspanning
- De zaaghoek instelling is digitaal afleesbaar via het bedieningsbord, alsook zijn deze nog manueel afleesbaar
- Laserlijn voor snelregeling
- Regelbaar koelvloeistofsysteem met directe koeling doorheen beide zaaggeleidingen op de bandzaag
- Andere voltages: 3 x 220 V en 3 x 440 V op aanvraag

Veiligheden:

- De kap van de zaagbeugel is uitgerust met een microscharnelaar, bij openen valt de machine stil en bij openen elektrische kast valt de machine eveneens uit. Tevens zijn de zaaggeleidingen afgeschermd
- Nullastspanning
- Aparte noodstop
- Vergrendelbare hoofdscharnelaar

Order nr.	800170715	
Algemeen		
Orig. nr.	BZH450X620 VARIO	
Vermogen		
Vermogen motor	kW	3
Afmetingen		
Zaagsnelheid	m/min	20-100
Afmetingen zaaglint (l x h x d)	mm	5200x34x1,1
Gewicht	kg	1100,00
Afmetingen (l x b x h)	mm	3200 x 1200 x 1650

BZH450X620



ZAAGBLADEN
ZIE VYNCKIER.BIZ

DUBBEL VERSTEK

HA

VARIO



• Overzichtelijke elektrische kast

• Manuele zaagbladspanning

• Zaagbreuk beveiliging

• Laserlijn voor snelregeling

• Frequentie-omvormer voor snelheid

• Hardmetalen plaatjes



• Digitale weergave snijhoek

• Borstel voor zaagbladreiniging

• Regeling klemkracht

• Elektrische koelmiddelinrichting



ZAAGCAPACITEIT					
37°		4 400 mm			622*440 mm
45°		4 400 mm			620*420 mm
55°		4 400 mm			300*300 mm
45°		4 400 mm			420*420 mm
60°		4 200 mm			280*280 mm



Standaard geleverd met:

- Koelpomp
- Bi-metalen zaagblad
- Bedieningsleutels
- Nederlandstalige handleiding, opschriften, CE - kenmerk, en CE-attest volgens Machine richtlijn 2006/42/CE, Laagspanningsrichtlijn 2006/95/CE en EMC Richtlijn 2004/108/CE



Verticale metaal bandzaagmachine in een solide structuur met laseenheid.

Troeven:

- Traploos regelbare zaagsnelheden
- Ingebouwde laseenheid
- Neigbare werktafel
- Machineverlichting

Geschied voor:

- Werkplaatsen, onderhoudsdiensten, scholen en opleidingcentra

Kenmerken:

- Uiterst stabiele bouwstructuur, volledige machinelichaam uit staal
- Gebruiksvriendelijke bedieningspaneel met degelijke werkplaatsverlichting
- Spanen eenvoudig verwijderen door wegblazen
- Zaagbladspanning en zaagbladsnelheidweergave
- Groot gedimensioneerde loopwielen
- De ingebouwde laseenheid (snijden, slijpen en verlassen) maakt het herstellen en op lengte aanmaken van nieuwe zaagbladen vanaf rol mogelijk.

Order nr.		713951407 
Orig. nr.		VMBS1408
Uitlading	mm	356
Maximum snijhoogte	mm	205
Hellingshoek werktafel links/rechts	°	12/15
Zaagbandlengte	mm	2880
Maximum zaagbandbreedte	mm	13
Zaagsnelheid (1ste gang)	m/min	20-80
Zaagsnelheid (2de gang)	m/min	-
Maximum zaagbandbreedte laseenheid	mm	13
Diameter loopwiel	mm	368
Diameter extra loopwiel boven	mm	-
Werkhoogte	mm	990
Vermogen motor	kW	0.75
Motor	V	3x400
Tafelafmetingen	mm	500x500
Verplaatsing tafel	mm	-
Gewicht	kg	275,00
Afmetingen (l x b x h)	mm	850 x 600 x 1740

VMBS1408

VARIO

205x356 mm

0,75KW

NEW

**Standaard geleverd met:**

- Werkstukaanslag
- Bedieningsleutels
- Nederlandstalige handleiding, opschriften, CE - kenmerk, en CE-attest volgens Machine richtlijn 2006/42/CE, Laagspanningsrichtlijn 2006/95/CE en EMC Richtlijn 2004/108/CE

Tip: wordt geleverd zonder zaagblad, vergeet uit rollen of gelaste uitvoering niet te bestellen



Verticale metaal bandzaagmachine in een solide structuur met laseenheid, met elektrische tafelvoeding.

Troeven:

- Traploos regelbare zaagsnelheden
- Met 2-traps overbrenging van 20 tot 1000 m/min
- Met elektrische tafelvoeding
- Ingebouwde laseenheid
- Neigbare werktafel
- Machineverlichting

Geschikt voor:

- Werkplaats, onderhoudsdienst, scholen en opleidingcentra

Kenmerken:

- Uiterst stabiele bouwstructuur, volledige machinelichaam uit staal
- Gebruiksvriendelijke bedieningspaneel met degelijke werkplaatsverlichting
- Spanen eenvoudig verwijderen door wegblazen
- Zaagbladspanning en zaagbladsnelheidweergave
- Groot gedimensioneerde loopwielen
- De ingebouwde laseenheid (snijden, slijpen en verlassen) maakt het herstellen en op lengte aanmaken van nieuwe zaagbladen vanaf rol mogelijk

Order nr.		713951611 
Orig. nr.		VMBS1610E
Uitlading	mm	396
Maximum snijhoogte	mm	255
Hellingshoek werktafel links/rechts	°	5/5
Zaagbandlengte	mm	3140
Maximum zaagbandbreedte	mm	16
Zaagsnelheid (1ste gang)	m/min	20-80
Zaagsnelheid (2de gang)	m/min	250-1000
Maximum zaagbandbreedte laseenheid	mm	16
Werkhoogte	mm	1000
Vermogen motor	kW	1,5
Motor	V	3x400
Tafelafmetingen	mm	550x600
Verplaatsing tafel	mm	300
Gewicht	kg	435,00
Afmetingen (l x b x h)	mm	940 x 675 x 1840

VMBS1610E

VARIO

255x396 mm

1,5KW



- Standaard met ingebouwde laseenheid (snijden, slijpen en lassen)



- Elektrische tafelvoeding

- Machineverlichting

- 2 trapoverbrenging
20 tot 1000 m/min

Standaard geleverd met:

- Werkstukaanslag
- Bedieningsleutels
- Nederlandstalige handleiding, opschriften, CE - kenmerk, en CE-attest volgens Machine richtlijn 2006/42/CE, Laagspanningsrichtlijn 2006/95/CE en EMC Richtlijn 2004/108/CE

Tip: wordt geleverd zonder zaagblad, vergeet uit rollen of gelaste uitvoering niet te bestellen



Verticale metaal bandzaagmachine in een solide structuur met laseenheid, met elektrische tafelveeding.

Troeven:

- Traploos regelbare zaagsnelheden
- Met 2-traps overbrenging van 15 tot 1500 m/min
- Met elektrische tafelveeding
- Ingebouwde laseenheid
- Neigbare werktafel 15/45°
- Machineverlichting

Geschikt voor:

- Werkplaatsen, onderhoudsdiensten, scholen en opleidingscentra

Kenmerken:

- Uiterst stabiele bouwstructuur, volledige machinelichaam uit staal
- Gebruiksvriendelijke bedieningspaneel met degelijke werkplaatsverlichting
- Spanen eenvoudig verwijderen door wegblazen
- Zaagbladspanning en zaagbladsnelheidweergave
- Groot gedimensioneerde loopwielen
- De ingebouwde laseenheid (snijden, slijpen en verlassen) maakt het herstellen en op lengte aanmaken van nieuwe zaagbladen vanaf rol mogelijk

Order nr.		713952012 
Orig. nr.		VMBS2012HE
Uitlading	mm	508
Maximum snijhoogte	mm	305
Hellingshoek werktafel links/rechts	°	5/5
Zaagbandlengte	mm	4030
Maximum zaagbandbreedte	mm	27
Zaagsnelheid (1ste gang)	m/min	15-125
Zaagsnelheid (2de gang)	m/min	165-1500
Maximum zaagbandbreedte laseenheid	mm	20
Diameter loopwiel	mm	515
Werkhoogte	mm	1016
Vermogen motor	kW	2.25
Motor	V	3x400
Tafelafmetingen	mm	600x700
Verplaatsing tafel	mm	300
Gewicht	kg	625,00
Afmetingen (l x b x h)	mm	1090 x 810 x 2030

VMBS2012HE

VARIO

305 x 508 mm

2,25KW

NEW



• Standaard met ingebouwde laseenheid (snijden, slijpen en lassen)

• Elektrische tafelvoeding



• Machineverlichting

• Cirkelsnijder standaard

• 2 trapoverbrenging 15 tot 1500 m/min

MACHINES

Standaard geleverd met:

- Werkstukaanslag
- Bedieningsleutels
- Nederlandstalige handleiding, opschriften, CE - kenmerk, en CE-attest volgens Machine richtlijn 2006/42/CE, Laagspanningsrichtlijn 2006/95/CE en EMC Richtlijn 2004/108/CE

Tip: wordt geleverd zonder zaagblad, vergeet uit rollen of gelaste uitvoering niet te bestellen

Materiaalsteunen



Samenploobbare materiaalsteun met rol.



Troeven:

- Traploos in hoogte verstelbaar met zware handgreep
- Samenplooibaar, gemakkelijk te transporteren
- Met stabiele verzinkte rol
- Draagkracht onderste positie 90 kg, midden 60 kg, hoogste positie 45 kg

Geschikt voor:

- Bandzagen, afkortzagen, en andere houtbewerkingsmachines

Order nr.	715900005	
Orig. nr.	MS3R	
Minimum/maximum hoogte legvlak	mm	670-1080
Capaciteit	kg	45-60-90
Maximum breedte	mm	285
Gewicht	kg	4,00
Afmetingen (l x b x h)	mm	430 x 500 x 1150
Prijs	€	26,90



Materiaalsteun met rol.



Troeven:

- Stabiele constructie
- Traploos in hoogte verstelbaar
- Eenvoudig te transporteren
- Samenplooibaar

Order nr.	715900003	
Orig. nr.	MS1R	
Minimum/maximum hoogte legvlak	mm	700-1150
Capaciteit	kg	70
Maximum breedte	mm	400
Gewicht	kg	10,00
Afmetingen (l x b x h)	mm	135 x 500 x 810
Prijs	€	65,90



Materiaalsteun met kogellagers.



Troeven:

- Traploos in hoogte verstelbaar
- Eenvoudig te transporteren
- Samenklapbaar

Order nr.	715900004	
Orig. nr.	MS1K	
Minimum/maximum hoogte legvlak	mm	700-1150
Capaciteit	kg	70
Maximum breedte	mm	450
Gewicht	kg	12,00
Afmetingen (l x b x h)	mm	135 x 500 x 810
Prijs	€	65,90



Zware gietijzeren materiaalsteun voor metaal -en houtbewerking.



Kenmerken :

- Voor gebruik in zware omstandigheden
- Capaciteit 700 kg
- Massieve stalen rollen en stabiele gietijzeren voet
- Traploos instelbare hoogte

Order nr.	713660700	
Orig. nr.	MS3	
Capaciteit	kg	700
Hoogte minimum/maximum	mm	580/950
Diameter rollen	mm	52
Bruikbare rolbreedte	mm	350
Gewicht	kg	16,00
Prijs	€	110,00



Zware gietijzeren materiaalsteun voor metaal -en houtbewerking. Voor gebruik in zware omstandigheden. Capaciteit 700kg. Massieve stalen rollen en stabiele gietijzeren voet. Geschikt voor ronde buizen. Traploos instelbare hoogte.



Order nr.	713660705	
Orig. nr.	MS3V	
Capaciteit	kg	700
Hoogte minimum/maximum	mm	580/790
Breedte maximum	mm	2x125
Diameter rollen	mm	52
Gewicht	kg	16,00
Prijs	€	123,00

Rollenbanen

holzstar



Schaar-rollebanen ook harmonica-rollebanen genoemd.

Troeven:

- Zeer robuute poten uit stalen kokers
- Volverzinkte rollen
- 360° draaibare kunststof wielen met rem
- Gemakkelijk koppelen van meerdere rollebanen met haaksysteem

Order nr.	715900012 ^M	
Orig. nr.	SRB130	
Minimum/maximum hoogte legvlak	mm	600-1000
Lengte rollebaan	mm	500-1400
Breedte rollebaan	mm	480
Statische draagkracht	kg	130
Gewicht	kg	36,00
Afmetingen (l x b x h)	mm	1480 x 670 x 970
Prijs	€	263,00

OPTIMUM



Rollebanen in de hoogte verstelbaar tot 1050 mm.

Troeven:

- Ideaal voor de aanvoer- als afvoer van lange en zware werkstukken
- Opleghoogte: in de hoogte verstelbaar van 650 tot 1050 mm
- Massieve en robuuste stalen rollen
- Stabiele uitvoering met sterke speciale profielen
- Voorzien stalen draagrollen langs beide zijden gelagerd
- Montage mogelijk van het LMS-lengtemeetsysteem (zie hierna)

Geschikt voor:

- Universeel te pasbaar voor diverse type machines: bandzaagmachines, cirkelzaagmachines, boommachines, etc. .

Geleverd met:

- Bevestigingsbeugels voor het aan elkaar monteren van verschillende rollebanen

Order nr.	713357001 ^M	713357002 ^M	713357003 ^M
Orig. nr.	MSR4H	MSR7H	MSR10H
Aantal voeten	4	4	6
Lengte rollebaan	mm 1000	mm 2000	mm 3000
Breedte rollebaan	mm 440	mm 440	mm 440
Hoogte rollebaan	mm 650 - 1050	mm 650 - 1050	mm 650 - 1050
Statische draagkracht	kg 500	kg 700	kg 700
Rollengte	mm 360	mm 360	mm 360
Diameter	mm 60	mm 60	mm 60
Gewicht	kg 33,00	kg 61,00	kg 80,00
Afmetingen (l x b x h)	mm 1100 x 470 x 180	mm 2100 x 470 x 180	mm 3100 x 470 x 180
Prijs	€ 195,00	€ 319,00	€ 769,00

OPTIMUM



Universeel digitaal meetsysteem.

Troeven:

- Behoudt de laatste meting in het geheugen
- Magnetisch meetsysteem
- Opklapbare aanslag
- Levensduur van de batterij tot 10 jaar
- Lineaire geleiding: smeervrij, lichte loop, slijtvast, corrosiebestendig

Geschikt voor:

- Opbouw op rollebaan MSR4H, MSR7H en MSR10H voor een perfecte langsmeting en een exacte positionering

Kenmerken:

- De afstand zaagsnit – startpunt meting kan opgeslagen worden als vast startpunt voor elke meting aan het begin van de rollebaan
- Voor serie metingen met een hoge precisie van 0,05 mm
- Automatisch inschakelen van afleescherm
- Meetsysteem schakelt automatisch uit bij langdurig niet-gebruik en behoudt de laatste meting in het geheugen
- Meetnauwkeurigheid : +/- (0,025 +0,02 x meetlengte (m))
- Opklapbare aanslag (vermindert de afstand van de meetafstand met 170 mm)

Tip: rollebaan wordt niet meegeleverd, vergeet deze niet bij te bestellen

Order nr.	713383851 ^M	713383852 ^M	713383853 ^M	713383854 ^M
Orig. nr.	LMS10	LMS20	LMS30	LMS40
Lengte	mm 1000	mm 2000	mm 3000	mm 4000
Bruikbare verplaatsing	mm 830	mm 1830	mm 2830	mm 3830
Gewicht	kg 7,00	kg 10,00	kg 12,00	kg 18,00
Afmetingen (l x b x h)	mm 1100 x 110 x 70	mm 2100 x 110 x 70	mm 3100 x 110 x 70	mm 4000 x 110 x 70
Prijs	€ 745,00	€ 849,00	€ 985,00	€ 1.095,00

OPTIMUM



PVC rollers voor MSR4H-MSR7H.

Troeven

- Eenvoudig te monteren optionele rollenset met slijtvaste zachte PVC coating.
- Deze rollen zijn uiterst geschikt voor het aanvoeren van zachte en gelakte materialen. Door de zachte PVC coating wordt het oppervlak van de profielen niet beschadigd tijdens het aanvoeren.
- Tijds winst: wanneer u een standaard MSR rollen hebt, kunt u eenvoudig deze PVC rollen tussen de bestaande rollen leggen, deze komen dan iets hoger te staan, zodat uw materiaal niet beschadigd wordt door de bestaande stalen rollen. Na gebruik eenvoudig uit te nemen en uw rollenbaan is opnieuw klaar voor zijn gewone werk

Geschikt voor:

- Voor het vertransporteren van roestvrij staal en aluminium

Geleverd met:

- Set van drie rollen, eenvoudig te monteren op de bijgeleverd beugels
- Opbergsysteem.

Order nr.	713357609
Orig. nr.	3357609
Gewicht	kg 7,00
Afmetingen (l x b x h)	mm 410 x 230 x 240
Prijs	€ 135,00

OPTIMUM



Losse rol voor rollenbaan MSR4H-MSR7H-MSR10H of om uw eigen rollenbanen te produceren. Compleet met draadstang en rollagers.

Order nr.	790024000
Orig. nr.	LR360
Rollengte	mm 360
Diameter	mm 59
Complete rol met draadstang lengte	mm 400
Draad	M12
Asdiameter	mm 17
Lagers	6003Z
Gewicht	kg 2,50
Prijs	€ 39,90

OPTIMUM



Tafelverlenging voor MSR rollenbanen.

Troeven:

- Kan langs beide zijden gemonteerd worden
- Voorkom zagen in de rollenbaan, bij zaagmachines onder hoek

Order nr.	713357004
Gewicht	kg 3,50
Prijs	€ 79,90

metalfast



type A



type B



type C

Stabiele rollenbanen met of zonder meetsystemen met draagkracht van 300 kg per meter.

Troeven:

- Draagkracht tot 300 kg per meter
- U-vormige constructieprofielen van 3 mm dik
- Verzinkte kogelgelagerde draagrollen
- Bruikbare rolbreedte 250 of 350 mm (zie tabel)
- Werkhoogte 880 mm +/-60 mm (verstelbare voeten)
- Roldiameter 60 mm, asdiameter 15 mm
- Gesloten plaatstalen onderzijde
- Geproduceerd in Duitsland

Type C: Standaard rollenbaan zonder meetsysteem of aanslag. Geschikt als aan- of afvoerbaan.

Type B: Rollenbaan met manueel meetsysteem op U-profiel, en omhoogklapbare materiaal aanslag. Nuttige meetlengte is de rollenbaanlengte -150 mm werkstukaanslag

Type A: Rollenbaan met meetsysteem met LED-aanduiding, op 230V. Manuele verstelbare aanslag (via handwiel), stabiele wagen is omhoogklapbaar. Nuttige meetlengte is de rollenbaanlengte -450 mm werkstukaanslag

Geschikt voor:

- Universeel toepasbaar voor diverse type machines: bandzaagmachines, cirkelzaagmachines, boommachines, etc. .

Optioneel:

- Kunststofrollen 4% op de basisprijis
- Verhoogde verstelbare voeten tot 1.020 mm 713679000
- Montage-adapter voor MKS-machines.
- Geveerde aanslag 713672221
- Pneumatisch terugkerende aanslag op A-modellen. 713672222

Bij bestelling: opgave linkse - of rechtse aanbouw aan uw machine

Order nr.	Orig. nr.	Type	Bruikbare rolbreedte mm	Lengte m	Aantal voeten	Gewicht kg	Prijs €
713661311	M 3661311	C	250	1	2	50,00	515,00
713661312	M 3661312	C	250	2	2	100,00	875,00
713661313	M 3661313	C	250	3	3	150,00	1.015,00
713661314	M 3661314	C	250	4	3	200,00	1.235,00
713661315	M 3661315	C	250	5	4	250,00	1.749,00
713661316	M 3661316	C	250	6	5	300,00	2.109,00
713661317	M 3661317	C	250	7	5	350,00	2.399,00
713661318	M 3661318	C	250	8	6	400,00	2.769,00
713661321	M 3661321	C	350	1	2	50,00	565,00
713661322	M 3661322	C	350	2	2	100,00	975,00
713661323	M 3661323	C	350	3	3	150,00	1.329,00
713661324	M 3661324	C	350	4	3	200,00	1.585,00
713661325	M 3661325	C	350	5	4	250,00	1.995,00
713661326	M 3661326	C	350	6	5	300,00	2.429,00
713661327	M 3661327	C	350	7	5	350,00	2.745,00
713661328	M 3661328	C	350	8	6	400,00	3.189,00
713661211	M 3661211	B	250	1	2	50,00	825,00
713661212	M 3661212	B	250	2	2	100,00	1.235,00
713661213	M 3661213	B	250	3	3	150,00	1.505,00
713661214	M 3661214	B	250	4	3	200,00	1.915,00
713661215	M 3661215	B	250	5	4	250,00	2.369,00
713661216	M 3661216	B	250	6	5	300,00	2.839,00
713661217	M 3661217	B	250	7	5	350,00	3.219,00
713661218	M 3661218	B	250	8	6	400,00	3.665,00
713661221	M 3661221	B	350	1	2	50,00	845,00
713661222	M 3661222	B	350	2	2	100,00	1.359,00
713661223	M 3661223	B	350	3	3	150,00	1.765,00
713661224	M 3661224	B	350	4	3	200,00	2.089,00
713661225	M 3661225	B	350	5	4	250,00	2.615,00
713661226	M 3661226	B	350	6	5	300,00	3.155,00
713661227	M 3661227	B	350	7	5	350,00	3.555,00
713661228	M 3661228	B	350	8	6	400,00	4.075,00
713661111	M 3661111	A	250	1	2	50,00	2.359,00
713661112	M 3661112	A	250	2	2	100,00	3.119,00
713661113	M 3661113	A	250	3	3	150,00	3.449,00
713661114	M 3661114	A	250	4	3	200,00	3.885,00
713661115	M 3661115	A	250	5	4	250,00	4.489,00
713661116	M 3661116	A	250	6	5	300,00	5.400,00
713661117	M 3661117	A	250	7	5	350,00	6.060,00
713661118	M 3661118	A	250	8	6	400,00	6.760,00
713661221	M 3661221	A	350	1	2	50,00	2.369,00
713661222	M 3661222	A	350	2	2	100,00	3.215,00
713661223	M 3661223	A	350	3	3	150,00	3.375,00
713661224	M 3661224	A	350	4	3	200,00	4.229,00
713661225	M 3661225	A	350	5	4	250,00	4.939,00
713661226	M 3661226	A	350	6	5	300,00	5.780,00
713661227	M 3661227	A	350	7	5	350,00	6.450,00
713661228	M 3661228	A	350	8	6	400,00	7.180,00

MACHINES

Magneetboormachines

ACCESSOIRES

p. 941

#metallsoft



Hoogwaardige magneetboormachine voor continu gebruik.

Troeven:

- Krachtige magneet van 15.000 N
- Krachtige motor van 1,1 kW
- **Met snelspanopname met Weldon 19 mm**
- Licht in gewicht
- Tot 40% tijds- en energiebesparing met kernboren tegenover klassieke boren

Geschikt voor:

- Het gebruik met kernboren met een snijdiepte tot 50 mm
- Ideaal voor gebruik op bouwerven op moeilijk bereikbare plaatsen
- Constructiebedrijven, herstelling allerhande machines

Kenmerken:

- Met krachtige printplaat
- Stabiel boren dankzij een lange pinolen-geleiding
- Kan ook omgekeerd of schuin gebruikt worden
- Het koelmiddel wordt doorheen de boor geleid
- Veiligheidsafscherming tegen wegvliegende delen
- Eenvoudige ombouw voor gebruik van gewone boren

Als u wenst te boren met volle boren, kunt u volgende optionele toebehoren bij bestellen: boorkopstaart 1/2"x20, 713876001: vervolgens een tankransboorkop 1,5-13mm, 713876002.

Standaard geleverd met:

- 1 snelspanopname kernboren
- 1 olietank
- 1 olieleiding
- 1 zeskantsleutel
- 3 handgrepen
- 1 kunststoffen draagkoffer
- 1 veiligheidsriem

MACHINES



Order nr.

713860351

Orig. nr.		MB351
Spanning	V	230
Voeding		Manueel
Maximum diameter kernboren	mm	35
Maximum boordiepte kernboren	mm	50
Weldon opname	mm	19
Spilopname		M27
Maximum diameter volle boren	mm	13
Maximum boordiepte volle boren	mm	140
Snelheid	tpm	330
Vermogen motor	kW	1,1
Afmetingen magneetvoet (l x b)	mm	165x80
Magneetcapaciteit	N	15000
Aantal snelheden		1
Gewicht	kg	12,70
Afmetingen (l x b x h)	mm	330 x 260 x 450
Prijs	€	599,00

metall-waff



Compacte magneetboormachine voor het werken in geringe ruimtes.

Troeven:

- Krachtige magneet van 15000 N
- Krachtige motor van 1,1 kW
- **Met geringe hoogte 200 mm**
- Licht in gewicht
- Tot 40% tijds- en energiebesparing met kernboren tegenover klassieke boren

Geschikt voor:

- Het gebruik met kernboren met een snijdiepte tot 50 mm
- Ideaal voor gebruik op bouwerven op moeilijk bereikbare plaatsen, **plaatsen met geringe hoogtes**
- Constructiebedrijven, herstelling allerhande machines

Kenmerken:

- Met krachtige printplaat
- Stabiel boren dankzij een lange pinolen-geleiding
- Kan ook omgekeerd of schuin gebruikt worden
- Het koelmiddel wordt doorheen de boor geleid
- Veiligheidsafscherming tegen wegvliegende delen
- **Met LED verlichting** voor in donkere, geringe ruimtes
- Bedieningshendel kan zowel links als rechts worden ingezet

Standaard geleverd met:

- 1 olietank
- 1 olieleiding
- 1 zeskantsleutel
- 1 handgreep
- 1 kunststoffen draagkoffer

**Order nr.****713860350 M**

Orig. nr.		MB351F
Spanning	V	230
Voeding		Manueel
Maximum diameter kernboren	mm	35
Maximum boordiepte kernboren	mm	30
Weldopname	mm	19
Spilopname		vast
Snelheid	tpm	390
Vermogen motor	kW	1,1
Afmetingen magneetvoet (l x b)	mm	165x80
Magneetcapaciteit	N	15000
Aantal snelheden		1
Gewicht	kg	13,80
Afmetingen (l x b x h)	mm	457 x 160 x 393
Prijs	€	569,00

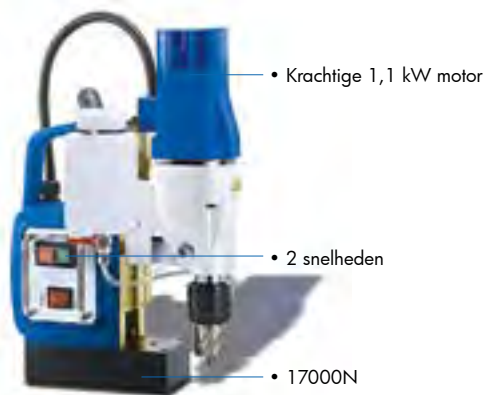

MB502E



MB502E

Krachtige magneetboormachine voor de veeleisende gebruiker.

Troeven:

- Krachtige magneet van 17000 N of 32000 N
- **2 snijsnelheden**
- Krachtige motor van 1,1 kW of 2 kW
- **Met snelspanname met Weldon 19 mm**
- Licht in gewicht
- Tot 40% tijds- en energiebesparing met kernboren tegenover klassieke boren

Geschied voor:

- het gebruik met kernboren met een snijdiepte tot 50 mm of 75 mm
- Ideaal voor gebruik op bouwerven op moeilijk bereikbare plaatsen
- Constructiebedrijven, herstelling allerhande machines

Kenmerken:

- Met krachtige printplaat
- MB502E is de economischere en lichtere versie tov MB502
- Stabiel boren dankzij een lange pinolen-geleiding
- Kan ook omgekeerd of schuin gebruikt worden
- Het koelmiddel wordt doorheen de boor geleid
- Veiligheidsafscherming tegen wegvliegende delen
- Eenvoudige ombouw voor gebruik van gewone boren

Als u wenst te boren met volle boren, kunt u volgende optionele toebehoren bij bestellen: boorkopstaart 1/2"x20, 713876006, tandkransboorkop 1-16 mm, 713876005. Voor de MB502E heeft u een andere boorkopstaart nodig 713876020 en tandkransboorkop 1-13 mm, 200850600

Standaard geleverd met:

- 1 snelspanopname kernboren
- 1 olietank
- 1 olieleiding
- 1 zeskantsleutel
- 3 handgrepen
- 1 kunststoffen draagkoffer
- 1 veiligheidsriem



Order nr.		713860500 ^(M)	713860502 ^(M)
Orig. nr.		MB502E	MB502
Spanning	V	230	230
Voeding		Manueel	Manueel
Maximum diameter kernboren	mm	50	50
Maximum boordiepte kernboren	mm	50	75
Weldopname	mm	19	19
Spilopname		M8	M24
Maximum diameter volle boren	mm	13	16
Maximum boordiepte volle boren	mm	140	110
Snelheid	tpm	180-270	230-300
Vermogen motor	kW	1,1	2
Afmetingen magneetvoet (l x b)	mm	180x90	200x100
Magneetcapaciteit	N	17000	32000
Aantal snelheden		2	2
Gewicht	kg	12,36	22,90
Afmetingen (l x b x h)	mm	330 x 125 x 476	340 x 290 x 570
Prijs	€	725,00	995,00

metall-wafl

- Lagere snelheden meer koppel



MB1204

Krachtige magneetboormachine met morse konus aansluiting en links/rechtsdraaiend voor de veeleisende gebruiker.

Troeven:

- Krachtige magneet van 32000 N
- **4 snijsnelheden**
- Krachtige motor van 2 kW
- **Met Morse Konus MK3 aansluiting**
- Tot 40% tijds - en energiebesparing met kernboren tegenover klassieke boren
- Links / rechtsdraaiend

Geschikt voor:

- Het gebruik met kernboren met een snijdiepte tot 50 mm
- Ideaal voor gebruik op bouwerven op moeilijk bereikbare plaatsen
- Constructiebedrijven, herstelling allerhande machines

Kenmerken:

- Met sterke printplaat
- Stabiel boren dankzij een lange pinolen-geleiding
- Kan ook omgekeerd of schuin gebruikt worden
- Het koelmiddel wordt doorheen de boor geleid
- Veiligheidsafscherming tegen wegvliegende delen
- Eenvoudige ombouw voor gebruik van gewone boren

Als u wenst te boren met volle boren, hebt u volgende optionele toebehore, nodig: boorkopstaart 713876007, tandkransboorkop 1-16mm, 713876005

Als uw wenst te tappen, hebt u volgende optionele toebehoren nodig: tapapparaat voor tapkoppen MK3 met M5 - M24 790024020: tapkoppen M5 - M6 790004170



MB754

- Krachtige 2 kW motor
- Links/rechts draaiend
- 4 snelheden
- Krachtige magneet 32000N

Standaard geleverd met:

- 1 adapter MK3 voor kernboren (enkel bij MB754)
- 1 olietank
- 1 olieleiding
- 1 zeskantsleutel
- 3 handgrepen
- 1 uitdrijfspie
- 1 draagkoffer
- 1 veiligheidsriem



Order nr.		713860754	713861204
Orig. nr.		MB754	MB1204
Spanning	V	230	230
Maximum diameter kernboren	mm	75	100
Maximum boordiepte kernboren	mm	50	50
Weldopname	mm	19	19
Spilopname		MK3	MK3
Maximum diameter volle boren	mm	31	31
Maximum boordiepte volle boren	mm	150	200
Snelheid	tpm	90-120-180-230	35-70-80-140
Vermogen motor	kW	2,0	2,0
Afmetingen magneetvoet (l x b)	mm	200x100	200x100
Magneetcapaciteit	N	32000	32000
Type		links-rechts	links-rechts
Aantal snelheden		4	4
Gewicht	kg	24,80	28,31
Afmetingen (l x b x h)	mm	330 x 125 x 476	330 x 125 x 576
Prijs	€	1.069,00	2.009,00



• Krachtige 1,1 kW motor

• 3 automatische voedingen

• Krachtige magneet 32000N

Magneetboormachine met automatische boorvoedingen.

Troeven:

- Krachtige magneet van 15000 N
- Krachtige motor van 1,1 kW
- **Met 3 automatische voedingen** (volgens kernboordiameter).
- Licht in gewicht
- Tot 40% tijds - en energiebesparing met kernboren tegenover klassieke boren

Geschikt voor:

- Het gebruik met kernboren met een snijdiepte tot 50 mm, in automatisch tot 45 mm
- Ideaal voor gebruik op bouwerven op moeilijk bereikbare plaatsen
- Constructiebedrijven, herstelling allerhande machines

Kenmerken:

- Met sterke printplaat
- Stabiel boren dankzij een lange pinolen-geleiding
- Kan ook omgekeerd of schuin gebruikt worden
- Automatische boorvoedingen volgens kernboordiameter
1 kernboordiameter 12-20mm
2 kernboordiameter 21-24mm
3 kernboordiameter 25-30mm
- Het koelmiddel wordt doorheen de boor geleid
- Veiligheidsafscherming tegen wegvliegende delen

Standaard geleverd met:

- 1 olietank
- 1 olieleiding
- 1 zeskantsleutel
- 3 handgrepen
- 1 kunststoffen draagkoffer



Order nr.	713860300 ^M	
Orig. nr.	MB301 AUTO	
Spanning	V	230
Voeding		manueel / auto
Maximum diameter kernboren	mm	35 / 30
Maximum boordiepte kernboren	mm	50 / 45
Weldopname	mm	19
Spilopname		M27
Maximum diameter volle boren	mm	13 / -
Maximum boordiepte volle boren	mm	110 / -
Snelheid	tpm	350
Vermogen motor	kW	1,1
Afmetingen magneetvoet (l x b)	mm	165x80
Magneetcapaciteit	N	15000
Gewicht	kg	16,50
Afmetingen (l x b x h)	mm	380 x 250 x 450
Prijs	€	1.199,00

metall-waif



Tandkrans boorkop met boorsleutel.

Order nr.	713876005
Voor type	MB502-MB754-MB1204
Aansluiting	5/8" x 16
Capaciteit	mm 1-16
Prijs	€ 20,50

RAUGH



Tandkrans boorhouder. Industriële kwaliteit.

Troeven::

- Met sleutel
- 3 bekken. Bekken zijn gehard en geslepen
- Met hoge spankracht
- Links-rechtsdraaiend

Geschikt voor:

- Voor gebruik op klopboormachines, boormachines, draaibanken en houtbewerkingsmachines

Tip: geleverd zonder kegeldoorn, vergeet deze niet bij te bestellen.

Order nr.	Aansluiting	Capaciteit	Sleuteltype	Diameter kop	Lengte	Prijs
	mm	mm	mm	mm	mm	€
200850600	1/2" x 20	1.5-13	KS2	42	59	7,60
200820207	B16	1-13	KS2	52	69	20,50
200820306	B18	3-16	KS3	49.5	75	25,90
200820405	B18	5-20	KS4	65	92	50,90

metall-waif



Boorkop adaptor voor magneetboormachines.

Kenmerken:

- Aansluiting 1/2" x 20 mm

Geschikt voor:

- Magneetboormachines MB351

Order nr.	713876001
Orig. nr.	3876001
Voor type	MB351
Gewicht	kg 0,12
Prijs	€ 17,00

metall-waif



Boorkopadaptor voor magneetboormachine.

Geschikt voor:

- Magneetboormachine MB502E

Order nr.	713876020
Prijs	€ 20,50

metall-waif



Boorkop adaptor magneetboormachine.

Kenmerken:

- Aansluiting 1/2" x 20 mm

Geschikt voor:

- Magneetboormachines MB502

Order nr.	713876004
Orig. nr.	3876004
Voor type	MB502
Gewicht	kg 0,48
Prijs	€ 15,90

metall-waif



Snelspan kernboorhouders.

Troeven:

- Snel wisselen van kernboren (Weldon 19,05 mm)
- Met aantrekdraad om stevig vast te klemmen in magneetboormachine

Geschikt voor:

- Magneetboormachines Metallkraft M24 voor MB351 / MB502E
- Magneetboormachines Metallkraft M27 voor MB502
- Andere magneetboormachines met een identieke aansluiting

Order nr.	713877351	713877502
Orig. nr.	WHSM24	WHSM27
Opname	M24	M27
Voor type	MB351 / MB502E	MB502
Gewicht	kg 1,08	1,20
Prijs	€ 75,90	83,50

metall-waif



Beugel voor MB754.

Geschikt voor montage op buizen.

Stabiele uitvoering met stevige ketting.

Order nr.	713867504
Orig. nr.	3867504
Capaciteit diameter buizen	mm ø 32 - ø 203
Gewicht	kg 5,00
Prijs	€ 207,00

MACHINES

KIES UW BOORMACHINE

	Vermogen	Boorvermogen in staal	Spijplnaam	Uitdijing in mm	Snelheden	Traploze spijlheaden	Koelinrichting	Tapfunctie	Automatische voeding	Machieverlichting	Snelpan boorkop	230V versie	400V versie	Tafelboormachine	Kolombormachine	Tandwiel aangedreven	Radiaal boormachine
B13	0,3	Ø 13	vast B16	104	520-2620							●		●			
B14	0,35	Ø 14	vast B16	104	520-2620						●	●		●			
B16	0,45	Ø 16	MK2	125	660 - 2500						●	●		●			
B20	0,55	Ø 20	MK2	170	210-2220						●	●		●			
B25	0,55	Ø 20	MK3	170	210-2220						●	●	●		●		
B 32	1,1	Ø 32	MK4	225	140-2020						●		●		●		
RB 6T	0,75	Ø 16	MK2	115-430	390-3000							●					●
RB 85	0,75	Ø 16	MK2	115-430	390-3000							●					●
B 17 Pro	0,5	Ø 16	MK2	180	500-2520						●	●		●			
B 23 Pro	0,75	Ø 25	MK2	180	200-2440						●	●	●	●	●		
B 26 Pro	0,75	Ø 25	MK3	10	200-2440						●		●		●		
B 33 Pro	1,1	Ø 30	MK4	254	120-1810						●		●				
B24 H	0,85	Ø 24	MK2	165	350-4000					●	●	●	●	●			
B28 H	0,85	Ø 28	MK3	200	120-4000					●	●	●	●		●		
B34 H	1,5/2,2	Ø 34	MK4	285	145-4800					●	●	●	●		●		
B16 HV	0,55	Ø 16	MK2	130	100-7500	●				●	●	●		●			
B24 HV	0,85	Ø 24	MK2	165	100-5950	●				●	●	●		●			
B28 HV	0,85	Ø 28	MK3	200	35-5600	●	●			●	●	●			●		
B34 HV	1,5/2,2	Ø 34	MK4	285	40-5000	●	●			●	●	●			●		
DH24BV	2,2	Ø 24	MK2	85	300 - 4000	●				●	●	●	●	●			
DH28BV	0,85 / 1,5	Ø 28	MK3	105	300 - 4000	●				●	●	●	●		●		
DH32BV	1,5	Ø 34	MK4	160	300 - 4000	●				●	●	●	●		●		
DH 26 GT	0,65	Ø 26	MK3	255	105-2900			●				●	●		●	●	●
DH 28 GS	0,65	Ø 26	MK3	255	105-2900			●		●	●	●	●		●	●	●
DH 32 GS	1,1/1,5	Ø 32	MK4	285	75 -2000			●	●	●	●	●	●		●	●	●
DH32GSV	2,2	Ø 32	MK4	285	40 - 3000	●	●	●	●	●	●	●	●		●	●	●
B40 E	1,1/1,5	Ø 28	MK4/M16	285	95 - 3200		●	●			●	●	●		●	●	●
B40 PTE	1,1/1,5	Ø 32	MK4/M16	285	95 - 3200		●		mech.		●	●	●		●	●	●
B40 GSP	1,5	Ø 35	MK4	350	64 - 3060		●		mech.		●	●	●		●	●	●
B40 GSM	1,5	Ø 35	MK4	350	64 - 3060		●		elek mag		●	●	●		●	●	●
B50 GSM	3/2,4	Ø 50	MK4	375	54 - 2090		●		elek mag	●		●	●		●	●	●
DR4	3	Ø40	MK4	580	75-1220	●			mech.	●		●	●		●	●	●

KIES DE ACCESSOIRES VOOR UW BOORMACHINE

ACCESSOIRES
p. 1078-1151

Accessoires voor boormachines		B13	B14	B16	B20	B25	B32	RB 6T	RB 85	B17 Pro	B23 Pro	B26 Pro	B33 Pro	B16 H/Vario	B24 H/Vario	B28 H/Vario	B34 H/Vario	DH 24BV	DH 28BV	DH 34BV	DH 26GT	DH 28GS	DH 32GS	DH32GSV	B40E/B40 PTE	B40 GSM/GSP	B50 GSM	
Boorkop MK2/1-16 mm	713050571			•	•			•	•	•	•			•	•			•										
Boorkop MK2 1-13 mm	713050572			•	•			•	•	•	•			•	•													
Boorkop MK2/0 - 8 mm	713050582			•	•			•	•	•	•			•	•			•										
Boorkop MK3/0-13 mm	713050585				•	•		•	•		•	•				•			•			•	•					
Boorkop MK3/0-16 mm	713050573					•					•	•				•			•			•	•					
Boorkop MK4/1-16 mm	713050574							•					•				•			•			•	•	•	•	•	•
Boorkop MK4/0-13 mm	713050587						•						•				•			•			•	•	•	•	•	•
Boorkop 0 - 13 mm	713050623	•	•	•	•	•	•	•	•	•	•	•	•	•	•	•	•	•	•	•	•	•	•	•	•	•	•	•
Boorkop 0 - 16 mm	713050626	•	•	•	•	•	•	•	•	•	•	•	•	•	•	•	•	•	•	•	•	•	•	•	•	•	•	•
Rohm boorkop 1 - 13 mm	713050656	•	•	•	•	•	•	•	•	•	•	•	•	•	•	•	•	•	•	•	•	•	•	•	•	•	•	•
Rohm boorkop 3 - 16 mm	713050657	•	•	•	•	•	•	•	•	•	•	•	•	•	•	•	•	•	•	•	•	•	•	•	•	•	•	•
Reductie MK3/MK2	713050663					•						•				•			•			•	•					
Reductie MK4/MK3	713050664							•					•				•			•				•	•		•	•
Reductie MK4/MK2	713050665							•					•				•			•				•	•		•	•
Reductie MK4/M16-MK2	790023036																									•		
Reductie MK4/M16 -MK3	790023037																									•		
Kegeldoorn MK 2 - B16	713050659			•	•			•	•	•	•			•	•			•										
Kegeldoorn MK 3 - B16	713050660					•						•				•			•			•	•					
Kegeldoorn MK 4 - B16	713050661						•						•				•			•				•	•			•
Kegeldoorn MK 5 - B16	790023034																									•		
Spiraalborenset	742162500	•	•	•	•	•	•	•	•	•	•	•	•	•	•	•	•	•	•	•	•	•	•	•	•	•	•	•
MK2 borenset	713051002			•	•	•	•	•	•	•	•	•	•	•	•	•	•	•	•	•	•	•	•	•	•	•	•	•
MK3 borenset	713051003					•	•					•	•			•			•			•	•		•	•	•	•
Tapapparaat	713352042				•	•	•	•	•	•	•	•	•	•	•	•	•	•	•	•	•	•	•	•	•	•	•	•
Conus uitdrijver MSP1	713050636			•	•	•	•	•	•	•	•	•	•	•	•	•	•	•	•	•	•	•	•	•	•	•	•	•
Conus uitdrijver MSP2	713050637							•					•				•			•				•	•	•	•	•
SB12 set spanbouten	790007315									•	•			•														
SB14 set spanbouten	790007317	•	•	•	•	•	•	•	•			•	•			•	•		•			•	•			•	•	•
SB18 set spanbouten	790007319	•																									•	•
Koelinrichting 230V	713352002	•	•	•	•	•	•	•	•	•	•	•	•	•	•	•	•	•	•	•	•	•	•	•	•	•	•	•
Koelinrichting 400V	713352001										•	•	•	•	•	•	•	•	•	•	•	•	•	•	•	•	•	•
Boorklem MSO 75	713000075	•	•	•	•	•	•	•	•	•	•	•	•	•	•	•	•	•	•	•	•	•	•	•	•	•	•	•
Boorklem MSO 100	713000100	•	•	•	•	•	•	•	•	•	•	•	•	•	•	•	•	•	•	•	•	•	•	•	•	•	•	•
Boorklem MSO 125	713000125	•	•	•	•	•	•	•	•	•	•	•	•	•	•	•	•	•	•	•	•	•	•	•	•	•	•	•
Boorklem MSO 150	713000150				•	•	•	•	•	•	•	•	•	•	•	•	•	•	•	•	•	•	•	•	•	•	•	•
BoorklemBMS 85	713000008	•	•	•	•	•	•	•	•	•	•	•	•	•	•	•	•	•	•	•	•	•	•	•	•	•	•	•
Boorklem BMS 100	713000010	•	•	•	•	•	•	•	•	•	•	•	•	•	•	•	•	•	•	•	•	•	•	•	•	•	•	•
Boorklem BMS 120	713000012	•	•	•	•	•	•	•	•	•	•	•	•	•	•	•	•	•	•	•	•	•	•	•	•	•	•	•
Boorklem BMS 150	713000015				•	•	•	•	•	•	•	•	•	•	•	•	•	•	•	•	•	•	•	•	•	•	•	•
Boorklem BMS 200	713000020																									•		
Boorklem BSI 100	713000210	•	•	•	•	•	•	•	•	•	•	•	•	•	•	•	•	•	•	•	•	•	•	•	•	•	•	•
Boorklem BSI 140	713000214						•																			•	•	•
Boorklem BSI 200	713000220																										•	•
Boorklem BSI-Q 100	713000230				•	•	•	•	•	•	•	•	•	•	•	•	•	•	•	•	•	•	•	•	•	•	•	•
Boorklem BSI-Q 140	713000234					•	•	•	•	•	•	•	•	•	•	•	•	•	•	•	•	•	•	•	•	•	•	•
Boorklem BSI-Q 200	713000240																										•	•

Deze tabel bevat alle aanbevolen accessoires. Afhankelijk van uw individuele situatie, kan het nodig zijn om accessoires te gebruiken.

Tafelboormachines riem-/snaaraangedreven

OPTI-HIT

0,3KW



ACCESSOIRES
p. 1078-1151



B13

Tafelboormachines met riem / snaaraandrijving - robuust en prijsgunstig

Troeven:

- Boren in staal tot 13 mm
- Opname vast B16 (geen morse conus opname)
- 5 snelheden
- Motor 300 Watt
- Robuust en prijsgunstig

Kenmerken:

- Gegarandeerde rondloopnauwkeurigheid beter dan 0.03 mm gemeten in de boerspindel
- Spil met precisie kogellagering
- Rustigere loop door aluminium riemschijven en beste krachtoverbrenging door vertande kwaliteit V riemen - snaren Gates
- Door de getande kwaliteitsaandrijfriemen verkrijgt de machine een aanzienlijk betere krachtoverbrenging en beduidend minder prestatieverlies
- Boordiepte aanslag
- Precies bewerkte werktafel met T-gleuven in diagonaalpatroon en centergat, van -45° tot +45° zwenkbaar en 360° draaibaar rond de kolom. D.m.v. van een brede tandlat wordt de tafel eenvoudig in de hoogte versteld
- Massieve, grote bodemplaat met T-gleuven

Veiligheden:

- Gebruiksvriendelijke bedieningsknoppen met aparte start- en stopdrukknop en aparte noodstop
- Nullastspanning.
- Degelijke booraafscherming **dubbel venster**, uitgerust met veiligheidsscharakelaar
- V-snaarkap uitgerust met veiligheidsscharakelaar

Standaard geleverd met:

- Tandkrans boorkop 1-13mm
- Nederlandstalige handleiding, opschriften, CE - kenmerk, en CE-attest volgens Machine richtlijn 2006/42/CE, Laagspanningsrichtlijn 2006/95/CE en EMC Richtlijn 2004/108/CE

Order nr.	713008131	
Orig. nr.		B13
Spanning	V	230
Vermogen motor	kW	0,300
Boorcap. in staal S235JR	mm	13
Boorcapaciteit bij continu gebruik S235JR	mm	12
Spilopname	MK	Vast/B16
Aantal snelheden		5
Spindeltoerental	min-1	520-2620
Boordiepte	mm	50
Uitlading	mm	104
Diameter kolom	mm	46
Afmetingen tafel (b x d)	mm	160x160
T-gleuven	mm	14
Zwenkbaarheid boortafel	°	+/- 45
Draaibaarheid boortafel	°	360
Afstand spindel-tafel	mm	240
Afstand spindel-voet	mm	325
Afmetingen voet (b x d)	mm	135x175
T-gleuven voet	mm	14
Gewicht	kg	19,00
Afmetingen (l x b x h)	mm	420 x 220 x 580
Prijs	€	153,00

OPTI

0,35KW



ACCESSOIRES
p. 1078-1151

• 5 snelheden
520 - 2620tpM

• Aparte
noodstop

• Booraafscherming
met microscharakelaar



B14

• Softgrip

• Vast/B16

• Werktafel
160x160mm

• Kolom
Ø 46 mm

Tafelboormachines met riem / snaaraandrijving - robuust en prijsgunstig.

Troeven:

- Boren in staal tot 14 mm
- Opname vast B16 (geen morse conus opname)
- 5 snelheden
- Motor 350 Watt met aluminium behuizing
- Robuust en prijsgunstig

Kenmerken:

- Gegarandeerde rondloopnauwkeurigheid beter dan 0.03 mm gemeten in de boorspindel
- Spil met precisie kogellagering
- Rustigere loop door aluminium riemschijven en beste krachtoverbrenging door vertande kwaliteit V riemen - snaren Gates
- Door de getande kwaliteitsaandrijfriemen verkrijgt de machine een aanzienlijk betere krachtoverbrenging en beduidend minder prestatieverlies
- Boordiepte aanslag
- Precies bewerkte werktafel met T-gleuven in diagonaalpatroon en centergat, van -45° tot +45° zwenkbaar en 360° draaibaar rond de kolom. D.m.v. van een brede tandlat wordt de tafel eenvoudig in de hoogte versteld
- Lange, ergonomische stervormige handgreep uit 3 stukken met "soft grip"
- Massieve, grote bodemplaat met T-gleuven

Veiligheden:

- Gebruiksvriendelijke bedieningsknopen met aparte start- en stopdrukknop en aparte noodstop
- Nullastspanning
- Degelijke booraafscherming **dubbel venster**, uitgerust met veiligheidsscharakelaar
- V-snaarkap uitgerust met veiligheidsscharakelaar

Standaard geleverd met:

- Snelspanboorkop 1-13 mm
- Nederlandstalige handleiding, opschriften, CE - kenmerk, en CE-attest volgens Machine richtlijn 2006/42/CE, Laagspanningsrichtlijn 2006/95/CE en EMC Richtlijn 2004/108/CE

Order nr.	713008141	
Orig. nr.		B14
Spanning	V	230
Vermogen motor	kW	0,350
Boorcap. in staal S235JR	mm	14
Boorcapaciteit bij continu gebruik S235JR	mm	12
Spilopname	MK	Vast/B16
Aantal snelheden		5
Spindeltoerental	min-1	520-2620
Boordiepte	mm	50
Uitlading	mm	104
Diameter kolom	mm	46
Afmetingen tafel (b x d)	mm	160x160
T-gleuven	mm	14
Zwenkbaarheid boortafel	°	+/- 45
Draaibaarheid boortafel	°	360
Afstand spindel-tafel	mm	330
Afstand spindel-voet	mm	440
Afmetingen voet (b x d)	mm	140x180
T-gleuven voet	mm	14
Gewicht	kg	21,00
Afmetingen (l x b x h)	mm	420 x 230 x 700
Prijs	€	223,00

OPTI

MK2

0,45kW

ACCESSOIRES

p. 1078-1151



B16

Tafelboormachines met riem / snaaraandrijving - robuust en prijsgunstig.

Troeven:

- Boren in staal tot 16 mm
- Opname morse konus MK2.
- 5 snelheden
- Motor 450 Watt met aluminium behuizing
- Robuust en prijsgunstig

Kenmerken:

- Gegarandeerde rondloopnauwkeurigheid beter dan 0,03 mm gemeten in de boorspindel
- Spil met precisie kogellagering
- Rustigere loop door aluminium riemschijven en beste krachtoverbrenging door vertande kwaliteit V riemen - snaren Gates
- Door de getande kwaliteitsaandrijfriemen verkrijgt de machine een aanzienlijk betere krachtoverbrenging en beduidend minder prestatieverlies
- Boordiepte aanslag
- Precies bewerkte werktafel met T-gleuven in diagonaalpatroon en centergat, van -45° tot +45° zwenkbaar en 360° draaibaar rond de kolom. D.m.v. van een brede tandlat wordt de tafel eenvoudig in de hoogte versteld
- Lange, ergonomische stervormige handgreep uit 3 stukken met "soft grip"
- Massieve, grote bodemplaat met T-gleuven

Veiligheden:

- Gebruiksvriendelijke bedieningsknoppen met aparte start- en stopdrukknop en aparte noodstop
- Nullastspanning
- Degelijke booraafscherming **dubbel venster**, uitgerust met veiligheidsscharakelaar
- V-snaarkap uitgerust met veiligheidsscharakelaar

Standaard geleverd met:

- Snelspanboorkop 1-16mm B16
- Kegeldoorn volgens DIN228 MK2/B16
- 2 T-moeren voor T-gleuf 14mm en draad M12.
- Nederlandstalige handleiding, opschriften, CE - kenmerk, en CE-attest volgens Machine richtlijn 2006/42/CE, Laagspanningsrichtlijn 2006/95/CE en EMC Richtlijn 2004/108/CE

Order nr.

713008161

Orig. nr.		B16
Spanning	V	1x230
Vermogen motor	kW	0,450
Boorcap. in staal S235JR	mm	16
Boorcapaciteit bij continu gebruik S235JR	mm	15
Spilopname	MK	2
Aantal snelheden		5
Spindeltoerental	min-1	660-2500
Boordiepte	mm	65
Uitlading	mm	125
Diameter kolom	mm	60
Afmetingen tafel (b x d)	mm	200x200
T-gleuven	mm	14
Zwenkbaarheid boortafel	°	+/- 45
Draaibaarheid boortafel	°	360
Afstand spindel-tafel	mm	390
Afstand spindel-voet	mm	525
Afmetingen voet (b x d)	mm	160x170
T-gleuven voet	mm	14
Gewicht	kg	36,00
Afmetingen (l x b x h)	mm	510 x 270 x 820
Prijs	€	324,00

OPTI^{id}

53KG

0,55KW

ACCESSOIRES

p. 1078-1151

Tafelboormachines met riem / snaaraandrijving - robuust en prijsgunstig.

Troeven:

- Boren in staal tot 20 mm
- Opname morse konus MK2
- 12 snelheden
- Motor 550 Watt met aluminium behuizing
- Zowel in 1 x 230 V als 3 x 400 V
- 400 V model links-rechtsdraaiend
- Robuust en prijsgunstig

Kenmerken:

- Gegarandeerde rondloopnauwkeurigheid beter dan 0,03 mm gemeten in de boorspindel
 - Spil met precisie kogellagering
 - Rustigere loop door aluminium riemschijven en beste krachtoverbrenging door vertande kwaliteit V riemen - snaren Gates
 - Door de getande kwaliteitsaandrijfriemen verkrijgt de machine een aanzienlijk betere krachtoverbrenging en beduidend minder prestatieverlies
 - Boordiepte aanslag
 - Precies bewerkte werktafel met T-gleuven in diagonaalpatroon en centergat, van -45° tot +45° zwenkbaar en 360° draaibaar rond de kolom. D.m.v. van een brede tandlat wordt de tafel eenvoudig in de hoogte veresteld
 - Lange, ergonomische stervormige handgreep uit 3 stukken met "soft grip"
 - Massieve, grote bodemplaat met T-gleuven
 - Ook verkrijgbaar in andere voltages: 713008202 - 3x220V
- Opmerking: 3x220V = krachtstroom (drijfkracht). Dit is niet hetzelfde als 1x230V mono = wisselstroom

Veiligheden:

- Gebruiksvriendelijke bedieningsknoppen met aparte start- en stopdrukknop en aparte noodstop
- Nullastspanning
- Degelijke booraafscherming **dubbel venster**, uitgerust met veiligheidsschakelaar
- V-snaarkap uitgerust met veiligheidsschakelaar

Standaard geleverd met:

- Snelspanboorkop 1-16 mm B16
- Kegeldoorn volgens DIN228 MK2/B16
- 2 T-moeren voor T-gleuf 14 mm en draad M12
- Nederlandstalige handleiding, opschriften, CE - kenmerk, en CE-attest volgens Machine richtlijn 2006/42/CE, Laagspanningsrichtlijn 2006/95/CE en EMC Richtlijn 2004/108/CE



B20

Order nr.		713008201 [Ⓜ]	713008203 [Ⓜ]
Orig. nr.		B20-230V	B20-400V
Spanning	V	1x230	3x400
Vermogen motor	kW	0,550	0,550
Boorcap. in staal S235JR	mm	20	20
Boorcapaciteit bij continu gebruik S235JR	mm	18	18
Spilopname	MK	2	2
Aantal snelheden		12	12
Spindeltoerental	min-1	210-2220	210-2220
Boordiepte	mm	85	85
Uitlading	mm	170	170
Diameter kolom	mm	70	70
Afmetingen tafel (b x d)	mm	275x275	275x275
T-gleuven	mm	14	14
Zwenkbaarheid boortafel	°	+/- 45	+/- 45
Draaibaarheid boortafel	°	360	360
Afstand spindel-tafel	mm	465	465
Afstand spindel-voet	mm	635	635
Afmetingen voet (b x d)	mm	205x200	205x200
T-gleuven voet	mm	14	14
Gewicht	kg	53,00	53,00
Afmetingen (l x b x h)	mm	700 x 350 x 990	700 x 350 x 990
Prijs	€	424,00	483,00

OPTI

MK2

0,5KW

ACCESSOIRES
p. 1078-1151



B17PRO

Tafelboormachines met riem / snaaraandrijving voor de werkplaats en onderhoudsdienst

Troeven:

- Boren in staal tot 16 mm
- Opname morse konus MK2
- 5 snelheden
- Motor 500 Watt met aluminium behuizing

Geschikt voor:

- Werkplaatsen, onderhoudsdiensten, scholen en opleidingscentra

Kenmerken:

- Gegarandeerde rondloopnauwkeurigheid **beter dan 0,02 mm** gemeten in de boorspindel
- Spil met precisie kogellagering
- Rustigere loop door aluminium riemschijven
- Door de getande kwaliteitsaandrijfriemen snaren verkrijgt de machine een aanzienlijk betere krachtoverbrenging en beduidend minder prestatieverlies
- Boordiepte aanslag
- Precies bewerkte werktafel met T-gleuven in diagonaalpatroon met koelrand, van -45° tot +45° zwenkbaar en 360° draaibaar rond de kolom. D.m.v. van een brede tandlat wordt de tafel eenvoudig in de hoogte versteld
- Aluminium handgreep uit één stuk met "soft grip"
- Massieve, grote bodemplaat met T-gleuven

Veiligheden:

- Gebruiksvriendelijke bedieningsknoppen met aparte start- en stopdrukknop en aparte noodstop
- Nullastspanning
- Degelijke booraafscherming dubbel venster, uitgerust met veiligheidsschakelaar
- V-snaarkap uitgerust met veiligheidsschakelaar

Standaard geleverd met:

- Optimum snelspan boorkop 1-16 mm B16
- Kegeldoorn volgens DIN228 MK2/B16
- 2 T-moeren voor T-gleuf 12mm en draad M10
- Nederlandstalige handleiding, opschriften, CE - kenmerk, en CE-attest volgens Machine richtlijn 2006/42/CE, Laagspanningsrichtlijn 2006/95/CE en EMC Richtlijn 2004/108/CE

Order nr.

713003171

Orig. nr.		B17PRO
Spanning	V	230
Vermogen motor	kW	0,500
Boorcap. in staal S235JR	mm	16
Boorcapaciteit bij continu gebruik S235JR	mm	12
Spilopname	MK	2
Aantal snelheden		5
Spindeltoerental	min-1	500-2520
Boordiepte	mm	65
Uitlading	mm	152
Diameter kolom	mm	60
Afmetingen tafel (b x d)	mm	235x220
T-gleuven	mm	12
Zwenkbaarheid boortafel	°	+/- 45
Draaibaarheid boortafel	°	360
Afstand spindel-tafel	mm	325
Afstand spindel-voet	mm	530
Afmetingen voet (b x d)	mm	245x400
T-gleuven voet	mm	16
Gewicht	kg	39,00
Afmetingen (l x b x h)	mm	600 x 260 x 860
Prijs	€	390,00

OPTI



MK2

0,75KW

ACCESSOIRES
p. 1078-1151



B23PRO

- 12 snelheden 200 - 2440tpM
- V-snaarkap met microsckelaar
- Aparte noodstop
- Rondloop nauwkeurigheid beter dan 0,02 mm
- Booraafscherming met microsckelaar
- Schuinstelbare tussen-tafel -45°/+45°
- Krachtige elektromotor
- Brede tandlat
- Kolom Ø 73 mm

Tafelboormachines met riem / snaaraandrijving voor de werkplaatsen en onderhoudsdiensten.

Troeven:

- Boren in staal tot 25 mm
- Opname morse konus MK2
- 12 snelheden
- Motor 750 Watt met aluminium behuizing
- Zowel in 1 x 230 V als 3 x 400 V verkrijgbaar
- 400 V model links-rechtsdraaiend

Geschikt voor:

- Werkplaatsen, onderhoudsdiensten, scholen en opleidingcentra

Kenmerken:

- Gegarandeerde rondloopnauwkeurigheid **beter dan 0,02 mm** gemeten in de boorspindel
- Spil met precisie kogellagering
- Rustigere loop door aluminium riemschijven
- Door de getande kwaliteitsaandrijfriemen snaren verkrijgt de machine een aanzienlijk betere krachtoverbrenging en beduidend minder prestatieverlies
- Boordiepte aanslag
- Precies bewerkte werktafel met T-gleuven in diagonaalpatroon met koelrand, van -45° tot +45° zwenkbaar en 360° draaibaar rond de kolom. D.m.v. van een brede tandlat wordt de tafel eenvoudig in de hoogte versteld
- Aluminium handgreep uit één stuk met "soft grip"
- Massieve, grote bodemplaat met T-gleuven
- B23Pro ook verkrijgbaar in andere voltages: 713003234 - 3 x 220 V; 713003232 - 3 x 440 V Opmerking: 3 x 220 V = krachtstroom (drijfkracht). Dit is niet hetzelfde als 1 x 230 V mono = wisselstroom

Veiligheden:

- Gebruiksvriendelijke bedieningsknoppen met aparte start- en stopdrukknop en aparte noodstop
- Nullastspanning
- Degelijke booraafscherming dubbel venster, uitgerust met veiligheidssckelaar
- V-snaarkap uitgerust met veiligheidssckelaar

Standaard geleverd met:

- Optimum snelspan boorkop 1 -16 mm B16
- Kegeldoorn volgens DIN228 MK2/B16
- 2 T-moeren voor T-gleuf 12 mm en draad M10
- Nederlandstalige handleiding, opschriften, CE - kenmerk, en CE-attest volgens Machine richtlijn 2006/42/CE, Laagspanningsrichtlijn 2006/95/CE en EMC Richtlijn 2004/108/CE

Order nr.		713003231	713003233
Orig. nr.		B23PRO-230V	B23PRO-400V
Spanning	V	1x230	3x400
Vermogen motor	kW	0,750	0,750
Boorcap. in staal S235JR	mm	25	25
Spilopname	MK	2	2
Aantal snelheden		12	12
Spindeltoerental	min-1	200-2440	200-2440
Boordiepte	mm	80	80
Uitlading	mm	180	180
Diameter kolom	mm	73	73
Afmetingen tafel (b x d)	mm	280x250	280x250
T-gleuven	mm	12	12
Zwenkbaarheid boortafel	°	+/- 45	+/- 45
Draaibaarheid boortafel	°	360	360
Afstand spindel-tafel	mm	360	360
Afstand spindel-voet	mm	610	610
T-gleuven voet	mm	16	16
Gewicht	kg	66,00	66,00
Afmetingen (l x b x h)	mm	650 x 320 x 1010	650 x 320 x 1010
Prijs	€	605,00	615,00

MACHINES

OPTIMUM

MK2

0,55KW

ACCESSOIRES

p. 1078-1151



- Rondloop nauwkeurigheid beter dan 0,015 mm
- Zware stabiele tussentafel
- Tot 3500 tpm



B16H

Professionele tafelboormachine met riem / snaaraandrijving voor de betere werkplaats of opleidingscentra.

Troeven:

- Boren in staal tot 13 mm
- Robuuste stabiele bouw
- Opname morse konus MK2
- 5 snelheden
- Motor 550 Watt met aluminium behuizing, 400 V
- Machine volledig gemonteerd

Geschikt voor:

- Werkplaatsen, onderhoudsdiensten, scholen en opleidingcentra

Kenmerken:

- Gegarandeerde rondloopnauwkeurigheid **beter dan 0,015 mm** gemeten in de boorspindel
- Spil met precisie kogellagering
- Rustigere loop door aluminium riemschijven
- Door de getande kwaliteitsaandrijfriemen verkrijgt de machine een aanzienlijk betere krachtoverbrenging en beduidend minder prestatieverlies. 7M industriële V-riem, gegarandeerde levensduur van de riem tot 10.000 werkkuren
- Boordiepte aanslag
- Zware, precies bewerkte werktafel met T-gleuven in diagonaalpatroon en 360° draaibaar rond de kolom. D.m.v. van een brede tandlat wordt de tafel eenvoudig in de hoogte vasteld.
- Massieve, grote bodemplaat met T-gleuven
- Aluminium handgreep uit één stuk met "soft grip"

Veiligheden:

- Gebruiksvriendelijke bedieningsknoppen met aparte start- en stopdrukknop en aparte noodstop
- Nullastspanning
- Degelijke boorafscherming, uitgerust met veiligheidsschakelaar
- V-snaarkap uitgerust met veiligheidsschakelaar

Standaard geleverd met:

- Optimum snelspan boorkop 1 -13mm B16
- Kegeldoorn volgens DIN228 MK2/B16
- 2 T-moeren voor T-gleuf 12mm en draad M10.
- Nederlandstalige handleiding, opschriften, CE - kenmerk, en CE-attest volgens Machine richtlijn 2006/42/CE, Laagspanningsrichtlijn 2006/95/CE en EMC Richtlijn 2004/108/CE

Order nr.

71302017

Orig. nr.		B16H 400V
Spanning	V	400V
Vermogen motor	kW	0.550
Boorcap. in staal S235JR	mm	13
Boorcapaciteit bij continu gebruik S235JR	mm	11
Spilopname	MK	2
Aantal snelheden		5
Spindeltoerental	min-1	450-3.500
Boordiepte	mm	65
Uitlading	mm	130
Diameter kolom	mm	60
Afmetingen tafel (b x d)	mm	230x245
T-gleuven	mm	12
Draaibaarheid boortafel	°	360
Afstand spindel-tafel	mm	370
Afstand spindel-voet	mm	495
Afmetingen voet (b x d)	mm	200x240
T-gleuven voet	mm	12
Gewicht	kg	65,00
Afmetingen (l x b x h)	mm	549 x 300 x 848
Prijs	€	699,00

OPTI

OPTIONELE SCHUINSTELBARE
BOORTAFEL - p. 971



Ø4KG

0,85KW

ACCESSOIRES
p. 1078-1151

MK2

- Gegarandeerde rondloop nauwkeurigheid beter dan 0,015 mm

- Booraafscherming met microscharakelaar

- Brede werktafel 280x300mm



B24H

Professionele tafelboormachine met riem / snaaraandrijving voor de betere werkplaats of opleidingscentra.

Troeven:

- Boren in staal tot 24 mm
- Opname morse konus MK2
- 7 snelheden
- Motor 850 Watt met aluminium behuizing
- Zowel in 1 x 230 V als 3 x 400 V verkrijgbaar
- Links-rechtsdraaiend
- Machine volledig gemonteerd

Geschikt voor:

- betere werkplaats, onderhoudsdienst, scholen en opleidingscentra

Kenmerken:

- Gegarandeerde rondloopnauwkeurigheid **beter dan 0,015 mm** gemeten in de boorspindel
- Spil met precisie kogellagering
- Rustigere loop door aluminium riemschijven
- Door de getande kwaliteitsaandrijfriemen verkrijgt de machine een aanzienlijk betere krachtoverbrenging en beduidend minder prestatieverlies. 7M industriële V-riem, gegarandeerde levensduur van de riem tot 10.000 werkuren
- Boordiepte aanslag
- Zware, precies bewerkte werktafel met T-gleuven in diagonaalpatroon en 360° draaibaar rond de kolom, voorzien van dubbele klemming. D.m.v. van een brede tandlat wordt de tafel eenvoudig in de hoogte vasteld
- Aluminium handgreep uit één stuk met "soft grip"
- Massieve, grote bodemplaat met T-gleuven
- Alle modellen zijn links - rechtsdraaiend ook 230V modellen
- 3 x 220 V model enkel mogelijk met transformator

Veiligheden:

- Gebruiksvriendelijke bedieningsknoppen met aparte start- en stopdrukknop en aparte noodstop
- Nullastspanning
- Degelijke booraafscherming, uitgerust met veiligheidsscharakelaar
- V-snaartrap uitgerust met veiligheidsscharakelaar

Standaard geleverd met:

- Optimum snelspan boorkop 1 -16 mm B16
- Kegeldoorn volgens DIN228 MK2/B16
- 2 T-moeren voor T-gleuf 14mm en draad M12
- Nederlandstalige handleiding, opschriften, CE - kenmerk, en CE-attest volgens Machine richtlijn 2006/42/CE, Laagspanningsrichtlijn 2006/95/CE en EMC Richtlijn 2004/108/CE

Order nr.		713020241	713020243
Orig. nr.		B24H 230V	B24H 400V
Spanning	V	1x230	3x400
Vermogen motor	kW	0,850	0,850
Boorcap. in staal S235JR	mm	24	24
Boorcapaciteit bij continu gebruik S235JR	mm	20	20
Spilopname	MK	2	2
Aantal snelheden		7	7
Spindeltoerental	min-1	350-4000	350-4000
Boordiepte	mm	85	85
Uitlading	mm	165	165
Diameter kolom	mm	80	80
Afmetingen tafel (b x d)	mm	280x300	280x300
T-gleuven	mm	14	14
Draaibaarheid boortafel	°	360	360
Afstand spindel-tafel	mm	515	515
Afstand spindel-voet	mm	681	681
Afmetingen voet (b x d)	mm	280x260	280x260
T-gleuven voet	mm	14	14
Gewicht	kg	84,00	84,00
Afmetingen (l x b x h)	mm	665 x 434 x 998	665 x 434 x 998
Prijs	€	1.295,00	1.295,00

Tafelboormachines Vario



Professionele tafelboormachine met riem / snaaraandrijving voor de betere werkplaats of opleidingscentra met variabele, traploos regelbare spijlsnelheden tot 7.500 tpm

Troeven:

- Boren in staal tot 16 mm
- Robuuste stabiele bouw
- Opname morse konus MK2
- Variabele toerentalregeling tot 7500 tpm (5 traps)
- Digitale LED display voor de spijlsnelheden
- Motor 1,5 kW met aluminium behuizing
- Machine volledig gemonteerd

Geschikt voor:

- Werkplaatsen, onderhoudsdiensten, scholen en opleidingscentra

Kenmerken:

- Gegarandeerde rondlooppauwkeurigheid **beter dan 0,015 mm** gemeten in de boorspindel
- Spil met precisie kogellagering
- Rustigere loop door aluminium riemschijven
- Door de getande kwaliteitsaandrijfriemen verkrijgt de machine een aanzienlijk betere krachtoverbrenging en beduidend minder prestatieverlies. 7M industriële V-riem, gegarandeerde levensduur van de riem tot 10.000 werkuren
- Boordiepte aanslag
- Zware, precies bewerkte werktafel met T-gleuven in diagonaalpatroon en 360° draaibaar rond de kolom. D.m.v. van een brede tandlat wordt de tafel eenvoudig in de hoogte vasteld
- Massieve, grote bodemplaat met T-gleuven
- Aluminium handgreep uit één stuk met "soft grip"

Veiligheden:

- Gebruiksvriendelijke bedieningsknopen met aparte start- en stopdrukknop en aparte noodstop
- Nullastspanning.
- Degelijke boorafschermering, uitgerust met veiligheidsschakelaar
- V-snaarkap uitgerust met veiligheidsschakelaar

Order nr.	713020218	
Orig. nr.		B16HV
Spanning	V	1x230
Vermogen motor	kW	1,5
Boorcap. in staal S235JR	mm	16
Boorcapaciteit bij continu gebruik S235JR	mm	13
Spilopname	MK	2
Aantal snelheden		5 (traploos)
Spindeltoerental	min-1	100-7.500
Boordiepte	mm	65
Uitlading	mm	130
Diameter kolom	mm	60
Afmetingen tafel (b x d)	mm	230x245
T-gleuven	mm	12
Draaibaarheid boortafel	°	360
Afstand spindel-tafel	mm	370
Afstand spindel-voet	mm	495
Afmetingen voet (b x d)	mm	200x240
T-gleuven voet	mm	12
Gewicht	kg	68,00
Afmetingen (l x b x h)	mm	600 x 360 x 1000
Prijs	€	1.655,00

B16H VARIO**ACCESSOIRES**

p. 1078-1151

MK2**1,5KW****16****16**

- Digitale weergave spilsnelheden
- Snelspan-boorkop Optimum
- Boorafscherm met microscharnelaar
- Zware stabiele tussentafel
- Traploos regelbare toerental tot 7500 tpm

**Standaard geleverd met:**

- Optimum snelspan boorkop 0-13 mm B16
- Kegeldoorn volgens DIN228 MK2/B16
- 2 T-moeren voor T-gleuf 12 mm en draad M10
- Nederlandstalige handleiding, opschriften, CE - kenmerk, en CE-attest volgens Machine richtlijn 2006/42/CE, Laagspanningsrichtlijn 2006/95/CE en EMC Richtlijn 2004/108/CE



Professionele fafelboormachine met variabele toerentalregeling.

Troeven:

- Boren in staal tot 24 mm
- Opname morse konus MK2
- **Duitse Variomatic variabele toerentalregeling mechanisch systeem, niet langer snaren / riemen verleggen**
- Digitale LED snelheidsweergave
- Machineverlichting
- Krachtige tweesneldsmotor 0,85/1,5 kW
- Links-rechtsdraaiend
- Machine volledig gemonteerd

Geschikt voor:

- Werkplaatsen, onderhoudsdiensten, scholen en opleidingscentra, algemene industrie
- Het verwerken van verschillende soorten materialen

Kenmerken:

- Gegarandeerde rondlooptrouwkeurigheid **beter dan 0,015 mm** gemeten in de boorspindel
- Aluminium handgreep uit één stuk met "soft grip".
- Spil met precisie kogellagering.
- Boordiepte aanslag
- 7M industriële V-riem, gegarandeerde levensduur van de riem tot 10.000 werkkuren.
- Zware, precies bewerkte werktafel met T-gleuven in diagonaalpatroon en 360° draaibaar rond de kolom, voorzien van dubbele klemming. D.m.v. van een brede tandlat wordt de tafel eenvoudig in de hoogte versteld.
- Massieve, grote bodemplaat met T-gleuven.
- 3 x 220 V model enkel mogelijk met transformator

Veiligheden:

- Gebruiksvriendelijke bedieningsknoppen met aparte start- en stopdrukknop en aparte noodstop
- Nullastspanning
- Degelijke boorafscherming, uitgerust met veiligheidsschakelaar
- V-snaarkap uitgerust met veiligheidsschakelaar

Order nr.	713020420	
Orig. nr.	DH24BV 400V	
Spanning	V	400
Vermogen motor	kW	0,85/1,5
Boorcap. in staal S235JR	mm	24
Boorcapaciteit bij continu gebruik S235JR	mm	20
Spilopname	MK	2
Aantal trappen		2
Spindeltoerental	min-1	300 - 4.000
Boordiepte	mm	85
Uitlading	mm	165
Afmetingen tafel (b x d)	mm	280x300
T-gleuven	mm	14
Afstand spindelvoet	mm	681
Afmetingen voet (b x d)	mm	280x260
Gewicht	kg	80,00
Afmetingen (l x b x h)	mm	665 x 434 x 1000
Prijs	€	2.209,00



 Duits Vario
mechanisme systeem

Traploos instelbare overbrenging

- Zeer betrouwbaar door manuele snelheidsverstelling
- Krachtige stille werking
- Duurzame V-snaren
- Snelheidsverandering terwijl de machine draait



0,85KW/1,5KW

MK2

VARIO



OPTIONELE SCHUINSTELBARE
BOORTAFEL – p. 971



- Digitale LED
snelheidsweergave

- Aluminium handgreep
met softgrip

- Machineverlichting

- Brede tandlat

- Zware werktafel

- Massieve bodemplaat



Standaard geleverd met:

- Optimum snelspan boorkop 1-16 mm B16
- Kegeldoorn volgens DIN228 MK2/B16
- 2 T-moeren voor T-gleuf 14 mm en draad M12.
- Nederlandstalige handleiding, opschriften, CE - kenmerk, en CE-attest volgens Machine richtlijn 2006/42/CE, Laagspanningsrichtlijn 2006/95/CE en EMC Richtlijn 2004/108/CE



Professionele tafelboormachine met riem / snaaraandrijving met variabele, traploos regelbare spilsnelheden tot 5.950 tpm voor de betere werkplaats of opleidingscentra.

Troeven:

- Boren in staal tot 24 mm
- Opname morse konus MK2
- Variabele toerentalregeling tot 5.950 tpm (4 traps)
- Digitale LED display voor de spilsnelheden
- Motor 1,5 kW met aluminium behuizing
- Machine volledig gemonteerd

Geschikt voor:

- Werkplaatsen, onderhoudsdiensten, scholen en opleidingscentra

Kenmerken:

- Gegarandeerde rondlooppauwkeurigheid **beter dan 0,015 mm** gemeten in de boorspindel
- Spil met precisie kogellagering
- Rustigere loop door aluminium riemschijven
- Door de getande kwaliteitsaandrijfriemen verkrijgt de machine een aanzienlijk betere krachtoverbrenging en beduidend minder prestatieverlies. 7M industriële V-riem, gegarandeerde levensduur van de riem tot 10.000 werkuren
- Boordiepte aanslag
- Zware, precies bewerkte werktafel met T-gleuven in diagonaalpatroon en 360° draaibaar rond de kolom, voorzien van dubbele klemming. D.m.v. van een brede tandlat wordt de tafel eenvoudig in de hoogte vasteld
- Aluminium handgreep uit één stuk met "soft grip"
- Massieve, grote bodemplaat met T-gleuven

Veiligheden:

- Gebruiksvriendelijke bedieningsknopen met aparte start- en stopdrukknop en aparte noodstop
- Nullastspanning
- Degelijke boorafscherming, uitgerust met veiligheidsschakelaar
- V-snaarkap uitgerust met veiligheidsschakelaar

Order nr.	713020245 	
Orig. nr.		B24HV
Spanning	V	1x230
Vermogen motor	kW	1,5
Boorcap. in staal S235JR	mm	24
Boorcapaciteit bij continu gebruik S235JR	mm	20
Spilopname	MK	2
Aantal snelheden		4 (traploos)
Spindeltoerental	min-1	100-5950
Boordiepte	mm	85
Uitlading	mm	165
Diameter kolom	mm	80
Afmetingen tafel (b x d)	mm	280x300
T-gleuven	mm	14
Draaibaarheid boortafel	°	360
Afstand spindel-tafel	mm	515
Afstand spindel-voet	mm	681
Afmetingen voet (b x d)	mm	280x260
T-gleuven voet	mm	14
Gewicht	kg	85,00
Afmetingen (l x b x h)	mm	665 x 434 x 998
Prijs	€	2.419,00

ACCESSOIRES

p. 1078-1151

VARIO



MK2

1,5KW

- 
- Digitale weergave spilsnelheden
 - Traploos regelbaar toerental tot 5950 tpm
 - Links/rechts 2 snelheden
 - Snelspanboorkop Optimum
 - Kolom Ø 80 mm
 - Brede werktafel 280x300mm

Standaard geleverd met:

- Optimum snelspan boorkop 1 -16mm B16
- Kegeldoorn volgens DIN228 MK2/B16
- 2 T-moeren voor T-gleuf 14mm en draad M12.
- Nederlandstalige handleiding, opschriften, CE - kenmerk, en CE-attest volgens Machine richtlijn 2006/42/CE, Laagspanningsrichtlijn 2006/95/CE en EMC Richtlijn 2004/108/CE

Tafelboormachines tandwielaangedreven

OPTIMUM

Tandwiel aangedreven tafelboormachine voor montagebedrijven en de algemene industrie.

Troeven:

- Boren in staal tot 26 mm
- **Tandwieloverbrenging**
- Opname morse konus MK3
- 8 snelheden
- Tweesnelheidsmotor 1,1 / 1,5 kW
- Links-rechtsdraaiend
- Machineverlichting
- Machine volledig gemonteerd

Geschikt voor:

- Werkplaatsen, onderhoudsdiensten, montagebedrijven, algemene industrie, scholen en opleidingscentra

Kenmerken:

- Zware, massieve gietijzeren uitvoering
- Onderhoudsarme aandrijving met vetsmering
- Geluidsarme loop dankzij geslepen meenemer met multivertanding
- Precieze omloopnauwkeurigheid spindel en een lange levensduur door geharde en geslepen spindel
- Gietijzeren dikwandige kolom voor grote krachtopnames en stabiliteit
- Groot gedimensioneerde gietijzeren werktafel, geslepen en voorzien van T-gleuven
- Massieve, grote bodemplaat met T-gleuven
- Boordiepte instelling met millimeter schaal
- Snelheidsinstelling door twee keuzeschakelaars aan de linker zijkant van de boorkop
- Andere voltages: 3 x 220 V en 3 x 440 V op aanvraag

Veiligheden:

- Degelijke booraafscherming met microscharnelaar, boormachine valt onmiddellijk stil bij het openen van de afscherming
- Nullastspanning
- Gebruiksvriendelijke bedieningsknoppen met aparte start- en stopdrukknop en aparte noodstop.

Order nr.	713034220 	
Orig. nr.		DH26GT
Spanning	V	3x400
Vermogen motor	kW	1.1/1.5
Boorcap. in staal S235JR	mm	26
Boorcapaciteit bij continu gebruik S235JR	mm	24
Spilopname	MK	3
Uitlading	mm	235
Aantal snelheden		8
Spindeltoerental	min-1	75-2900
Boordiepte	mm	127
Diameter kolom	mm	92
Afstand spindel-tafel	mm	450
Afmetingen tafel (b x d)	mm	380x380
T-gleuven	mm	14
Draaibaarheid boortafel	°	360
Afstand spindel-voet	mm	610
Afmetingen voet (b x d)	mm	350x322
T-gleuven voet	mm	14
Gewicht	kg	166,00
Afmetingen (l x b x h)	mm	600 x 380 x 1300
Prijs	€	1.959,00

ACCESSOIRES
p. 1078-1151



MK3

166KG

1,1KW/1,5KW

- 
- Krachtige, stille 2 stappen motor
 - 4-voudige ergonomisch spaakwiel
 - Tandwiel overbrenging
 - Gietijzeren dikwandige kolom
 - Groot gedimensioneerde werktafel over tandlat
 - Aparte noodstop
 - Links/rechts draaiend
 - Optionele boorkop
 - Afscherming met microscharnelaar
 - 8 snelheden 75-2900

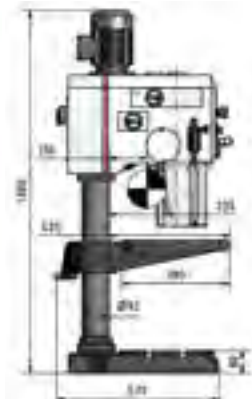

Standaard geleverd met:

- Kegeldoorn MK3 - B16
- Nederlandstalige handleiding, opschriften, CE - kenmerk, en CE-attest volgens Machine richtlijn 2006/42/CE, Laagspanningsrichtlijn 2006/95/CE en EMC Richtlijn 2004/108/CE

Opgepast: snelspan boorkop is NIET inbegrepen

Kolomboormachines riem-/snaaraangedreven



Kolomboormachines met riem / snaaraandrijving - robuust en prijsgunstig.

Troeven:

- Boren in staal tot 20 mm
- Opname morse konus MK3
- 12 snelheden
- Motor 550 Watt met aluminium behuizing
- Zowel in 1 x 230 V als 3 x 400 V
- 400 V model links-rechtsdraaiend
- Robuust en prijsgunstig

Kenmerken:

- Gegarandeerde rondloopnauwkeurigheid beter dan 0,03 mm gemeten in de boorspindel
 - Stille kwalitatieve elektromotoren
 - Spil met precisie kogellagering
 - Rustigere loop door aluminium riemschijven
 - Door de getande kwaliteitsaandrijfriemen verkrijgt de machine een aanzienlijk betere krachtoverbrenging en beduidend minder prestatieverlies
 - Boordiepte aanslag
 - Precies bewerkte werktafel met T-gleuven in diagonaalpatroon, van -45° tot +45° zwenkbaar en 360° draaibaar rond de kolom.
- D.m.v. van een brede tandlat wordt de tafel eenvoudig in de hoogte versteld
- Massieve, grote bodemplaat met T-gleuven
 - Lange, ergonomische stervormige handgreep uit 3 stukken met "soft grip"
 - B25 ook verkrijgbaar in andere voltages: 71300825 - 3 x 220 V Opmerking: 3 x 220 V = krachtstroom (drijfkracht). Dit is niet hetzelfde als 1 x 230 V mono = wisselstroom

Veiligheden:

- Gebruiksvriendelijke bedieningsknopen met aparte start- en stopdrukknop en aparte noodstop
- Nullastspanning
- Degelijke boorafscherming **dubbel venster**, uitgerust met veiligheidsschakelaar
- V-snaarkap uitgerust met veiligheidsschakelaar

Order nr.		713008251	713008253
Orig. nr.		B25-3-230V	B25-3-400V
Spanning	V	1x230	3x400
Vermogen motor	kW	0,550	0,550
Boorcap. in staal S235JR	mm	20	20
Boorcapaciteit bij continu gebruik S235JR	mm	18	18
Spilopname	MK	3	3
Aantal snelheden		12	12
Spindeltoerental	min-1	210-2220	210-2220
Boordiepte	mm	85	85
Uitlading	mm	170	170
Diameter kolom	mm	70	70
Afmetingen tafel (b x d)	mm	275x275	275x275
T-gleuven	mm	14	14
Zwenkbaarheid boortafel	°	+/- 45	+/- 45
Draaibaarheid boortafel	°	360	360
Afstand spindel-tafel	mm	760	760
Afstand spindel-voet	mm	1210	1210
Afmetingen voet (b x d)	mm	235x220	235x220
T-gleuven voet	mm	14	14
Gewicht	kg	60,00	60,00
Afmetingen (l x b x h)	mm	690 x 390 x 1570	690 x 390 x 1570
Prijs	€	549,00	539,00

B25-3

ACCESSOIRES
p. 1078-1151

MK3

0,55KW

- 12 snelheden
210 - 2220tpM
- Aparte
noodstop
- MK3
- Werktafel
275x275mm
- Kolom Ø 70 mm

**Standaard geleverd met:**

- Snelspan boorkop 1-16 mm B16
- Kegeldoorn volgens DIN228 MK3/B16
- 2 T-moeren voor T-gleuf 14 mm en draad M12
- Nederlandstalige handleiding, opschriften, CE - kenmerk, en CE-attest volgens Machine richtlijn 2006/42/CE, Laagspanningsrichtlijn 2006/95/CE en EMC Richtlijn 2004/108/CE



Kolomboormachines met riem / snaaraandrijving - robuust en prijsgunstig.

Troeven:

- Boren in staal tot 32 mm
- Opname morse konus MK4
- 9 snelheden
- Motor 1,1 kW met aluminium behuizing
- Zowel in 1 x 230 V als 3 x 400 V
- 400 V model links-rechtsdraaiend
- Robuust en prijsgunstig

Kenmerken:

- Gegarandeerde rondloopnauwkeurigheid beter dan 0,03 mm gemeten in de boorspindel
 - Stille kwalitatieve elektromotoren
 - Spil met precisie kogellagering
 - Rustigere loop door aluminium riemschijven
 - Door de getande kwaliteitsaandrijfriemen verkrijgt de machine een aanzienlijk betere krachtoverbrenging en beduidend minder prestatieverlies
 - Boordiepte aanslag
 - Precies bewerkte werktafel met T-gleuven in diagonaalpatroon, van -45° tot +45° zwenkbaar en 360° draaibaar rond de kolom.
- D.m.v. van een brede tandlat wordt de tafel eenvoudig in de hoogte versteld
- Massieve, grote bodemplaat met T-gleuven
 - Lange, ergonomische stervormige handgreep uit 3 stukken met "soft grip"
 - B32 ook verkrijgbaar in andere voltages: 713008322 - 3 x 220 V Opmerking: 3 x 220 V = krachtstroom (drijfkracht). Dit is niet hetzelfde als 1 x 230 V mono = wisselstroom

Veiligheden:

- Gebruiksvriendelijke bedieningsknopen met aparte start- en stopdrukknop en aparte noodstop
- Nullastspanning
- Degelijke booraafscherming **dubbel venster**, uitgerust met veiligheidsschakelaar
- V-snaarkap uitgerust met veiligheidsschakelaar

Order nr.		713008321	713008323
Orig. nr.		B32-4-230V	B32-4-400V
Spanning	V	1x230	3x400
Vermogen motor	kW	1,1	1,1
Boorcap. in staal S235JR	mm	32	32
Boorcapaciteit bij continu gebruik S235JR	mm	28	28
Spilopname	MK	4	4
Aantal snelheden		9	9
Spindeltoerental	min-1	140-2020	140-2020
Boordiepte	mm	85	85
Uitlading	mm	225	225
Diameter kolom	mm	92	92
Afmetingen tafel (b x d)	mm	360x360	360x360
T-gleuven	mm	14	14
Zwenkbaarheid boortafel	°	+/- 45	+/- 45
Draaibaarheid boortafel	°	360	360
Afstand spindel-tafel	mm	600	600
Afstand spindel-voet	mm	1170	1170
Afmetingen voet (b x d)	mm	360x600	360x600
T-gleuven voet	mm	14	14
Gewicht	kg	135,00	113,00
Afmetingen (l x b x h)	mm	790 x 400 x 1730	790 x 400 x 1730
Prijs	€	925,00	895,00

B32-4



ACCESSOIRES
p. 1078-1151

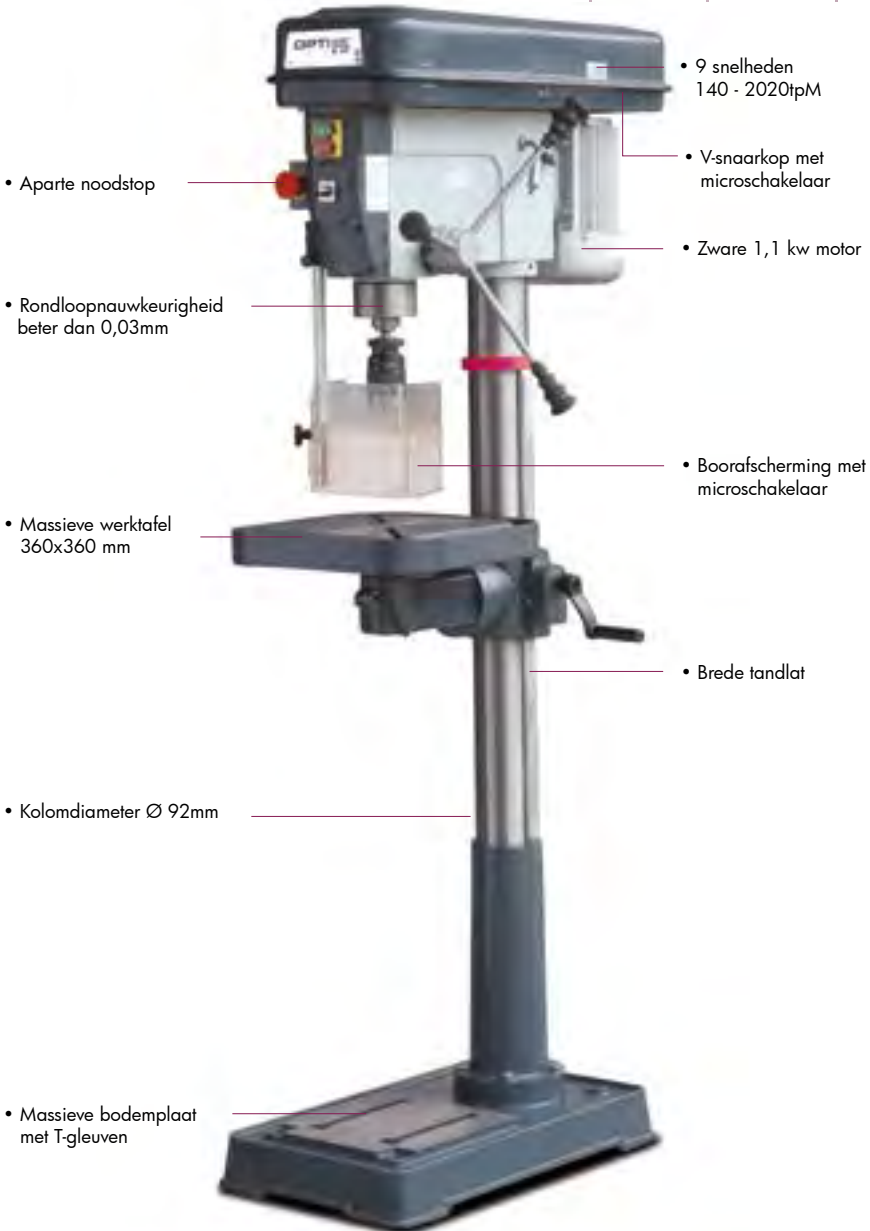

- Aparte noodstop
- Rondlooptrouwkeurigheid beter dan 0,03mm
- Massieve werktafel 360x360 mm
- Kolomdiameter Ø 92mm
- Massieve bodemplaat met T-gleuven
- 9 snelheden 140 - 2020tpM
- V-snaarkop met microscharnelaar
- Zware 1,1 kw motor
- Booraafscherming met microscharnelaar
- Brede tandlat

MACHINES

Standaard geleverd met:

- Snelspan boorkop 1-16 mm B16
- Kegeldoorn volgens DIN228 MK4/B16
- 2 T-moeren voor T-gleuf 14 mm en draad M12.
- Nederlandstalige handleiding, opschriften, CE - kenmerk, en CE-attest volgens Machine richtlijn 2006/42/CE, Laagspanningsrichtlijn 2006/95/CE en EMC Richtlijn 2004/108/CE



Kolomboormachines met riem / snaaraandrijving voor de werkplaats en onderhoudsdienst

Troeven:

- Boren in staal tot 25 mm
- Opname morse konus MK3
- 12 snelheden
- Motor 750 Watt met aluminium behuizing
- Zowel in 1 x 230 V als 3 x 400 V verkrijgbaar
- 400 V model links-rechtsdraaiend

Geschikt voor:

- Werkplaats, onderhoudsdienst, scholen en opleidingscentra

Kenmerken:

- Gegarandeerde rondloopnauwkeurigheid **beter dan 0,02 mm** gemeten in de boorspindel
- Spil met precisie kogellagering
- Rustigere loop door aluminium riemschijven
- Door de getande kwaliteitsaandrijfriemen snaren verkrijgt de machine een aanzienlijk betere krachtoverbrenging en beduidend minder prestatieverlies
- Boordiepte aanslag
- Precies bewerkte werktafel met T-gleuven in diagonaalpatroon met koelrand, van -45° tot +45° zwenkbaar en 360° draaibaar rond de kolom. D.m.v. van een brede tandlat wordt de tafel eenvoudig in de hoogte versteld
- Aluminium handgreep uit één stuk met "soft grip"
- Massieve, grote bodemplaat met T-gleuven
- B26Pro ook verkrijgbaar in andere voltages: 713003262 - 3x220V; 713003268 - 3 x 440 V Opmerking: 3 x 220 V = krachtstroom (drijfkracht). Dit is niet hetzelfde als 1 x 230 V mono = wisselstroom

Veiligheden:

- Gebruiksvriendelijke bedieningsknopen met aparte start- en stopdrukknop en aparte noodstop
- Nullastspanning
- Degelijke booraafscherming dubbel venster, uitgerust met veiligheidsschakelaar
- V-snaarkap uitgerust met veiligheidsschakelaar

Order nr.		713003261	713003263
Orig. nr.		B26PRO-230V	B26PRO-400V
Spanning	V	1x230	3x400
Vermogen motor	kW	0,75	0,75
Boorcap. in staal S235JR	mm	25	25
Boorcapaciteit bij continu gebruik S235JR	mm	20	20
Spilopname	MK	3	3
Aantal snelheden		12	12
Spindeltoerental	min-1	200-2440	200-2440
Boordiepte	mm	85	85
Uitlading	mm	210	210
Diameter kolom	mm	80	80
Afmetingen tafel (b x d)	mm	330x290	330x290
T-gleuven	mm	14	14
Zwenkbaarheid boortafel	°	+/-45	+/-45
Draaibaarheid boortafel	°	360	360
Afstand spindel-tafel	mm	720	720
Afstand spindel-voet	mm	1230	1230
Afmetingen voet (b x d)	mm	325x500	325x500
T-gleuven voet	mm	16	16
Gewicht	kg	82,00	82,00
Afmetingen (l x b x h)	mm	700 x 350 x 1670	700 x 350 x 1670
Prijs	€	695,00	695,00

B26PRO

ACCESSOIRES

p. 1078-1151



- 
- 3 Aluminium riemschijven 12 spilsnelheden
 - Aparte noodstop
 - Rondloop nauwkeurigheid beter dan 0,02 mm
 - Boorafscherming met microscharnelaar
 - Schuinstelbare tussentafel -45°/+45°
 - Links/rechts schakelaar bij 3x400V
 - Soft grip
 - Brede tandlat
 - Zware bodemplaat

Standaard geleverd met:

- Optimum snelspan boorkop 1 -16 mm B16
- Kegeldoorn volgens DIN228 MK3/B16
- 2 T-moeren voor T-gleuf 14 mm en draad M12
- Nederlandstalige handleiding, opschriften, CE - kenmerk, en CE-attest volgens Machine richtlijn 2006/42/CE, Laagspanningsrichtlijn 2006/95/CE en EMC Richtlijn 2004/108/CE



Kolomboormachines met riem / snaaraandrijving voor de werkplaats en onderhoudsdienst.

Troeven:

- Boren in staal tot 30 mm
- Opname morse konus MK4
- 9 snelheden
- Groot gedimensioneerde werktafel
- Motor 1,1 kW met aluminium behuizing
- Zowel in 1 x 230 V als 3 x 400 V verkrijgbaar
- 400 V model links-rechtsdraaiend

Geschikt voor:

- Werkplaats, onderhoudsdienst, scholen en opleidingcentra

Kenmerken:

- Gegarandeerde rondlooptrouwbaarheid **beter dan 0,02 mm** gemeten in de boorspindel
- Spil met precisie kogellagering
- Rustigere loop door aluminium riemschijven
- Door de getande kwaliteitsaandrijfriemen snaren verkrijgt de machine een aanzienlijk betere krachtoverbrenging en beduidend minder prestatieverlies
- Boordiepte aanslag
- Precies bewerkte werktafel met T-gleuven in diagonaalpatroon met koelrand, van -45° tot +45° zwenkbaar en 360° draaibaar rond de kolom. D.m.v. van een brede tandlat wordt de tafel eenvoudig in de hoogte versteld
- Aluminium handgreep uit één stuk met "soft grip"
- Massieve, grote bodemplaat met T-gleuven
- B33Pro ook verkrijgbaar in andere voltages: 713003332 - 3x220V - 713003336 - 3 x 440 V Opmerking: 3 x 220 V = krachtstroom (drijfkracht). Dit is niet hetzelfde als 1 x 230 V mono = wisselstroom

Veiligheden:

- Gebruiksvriendelijke bedieningsknopen met aparte start- en stopdrukknop en aparte noodstop
- Nullastspanning.
- Degelijke boorafscherming **dubbel venster**, uitgerust met veiligheidsschakelaar
- V-snaarkap uitgerust met veiligheidsschakelaar

Order nr.		713003331	713003333
Orig. nr.		B33PRO-230V	B33PRO-400V
Spanning	V	1x230	3x400
Vermogen motor	kW	1,1	1,1
Boorcap. in staal S235JR	mm	30	30
Boorcapaciteit bij continu gebruik S235JR	mm	25	25
Spilopname	MK	4	4
Aantal snelheden		9	9
Spindeltoerental	min-1	120-1810	120-1810
Boordiepte	mm	120	120
Uitlading	mm	254	254
Diameter kolom	mm	92	92
Afmetingen tafel (b x d)	mm	475x425	475x425
T-gleuven	mm	14	14
Zwenkbaarheid boortafel	°	+/- 45	+/- 45
Draaibaarheid boortafel	°	360	360
Afstand spindel-tafel	mm	695	695
Afstand spindel-voet	mm	1180	1180
Afmetingen voet (b x d)	mm	450x570	450x570
T-gleuven voet	mm	16	16
Gewicht	kg	135,00	135,00
Afmetingen (l x b x h)	mm	860 x 480 x 1720	860 x 480 x 1720
Prijs	€	1.099,00	1.099,00

B33PRO

ACCESSOIRES

p. 1078-1151



- Aparte noodstop
- Rondloop nauwkeurigheid beter dan 0,02 mm
- Boorafscherming met microscharakelaar
- Groot gedimensioneerde werktafel 450x570 mm
- 3 aluminium riemschijven 9 spilsnelheden
- Links/rechts omschakelaar bij 3x400V
- Krachtige elektromotor
- Soft grip
- Röhm snelspanboorkop 3-16 mm
- Brede tandlat
- Zware bodemplaat

Standaard geleverd met:

- Optimum snelspan boorkop 1-16 mm B16
- Kegeldoorn volgens DIN228 MK4/B16
- 2 T-moeren voor T-gleuf 14 mm en draad M12
- Nederlandstalige handleiding, opschriften, CE - kenmerk, en CE-attest volgens Machine richtlijn 2006/42/CE, Laagspanningsrichtlijn 2006/95/CE en EMC Richtlijn 2004/108/CE



Professionele kolomboormachine met riem / snaaraandrijving voor de betere werkplaats of opleidingscentra.

Troeven:

- Boren in staal tot 28 mm
- Opname morse konus MK3
- 16 snelheden
- Motor 850 Watt
- Zowel in 1x230V als 3x400V verkrijgbaar
- Links-rechtsdraaiend
- Ingebouwde machineverlichting
- Machine volledig gemonteerd

Geschikt voor:

- betere werkplaats, onderhoudsdienst, scholen en opleidingcentra

Kenmerken:

- Gegarandeerde rondloopnauwkeurigheid **beter dan 0,015 mm** gemeten in de boorspindel
- Spil met precisie kogellagering.
- Rustigere loop door aluminium riemschijven
- Door de getande kwaliteitsaandrijfriemen verkrijgt de machine een aanzienlijk betere krachtoverbrenging en beduidend minder prestatieverlies. 7M industriële V-riem, gegarandeerde levensduur van de riem tot 10.000 werkuren.
- Boordiepte aanslag.
- Zware, precies bewerkte werktafel met T-gleuven in diagonaalpatroon en 360° draaibaar rond de kolom, voorzien van dubbele klemming. D.m.v. van een brede tandlat wordt de tafel eenvoudig in de hoogte vasteld.
- Stalen stervormige handgreep uit 3 stukken
- Eenvoudigere gereedschapswissel door automatische booruitdrijver
- Massieve, grote bodemplaat met T-gleuven.
- Alle modellen zijn links - rechtsdraaiend ook 230 V modellen
- 3 x 220 V model enkel mogelijk met transformator

Veiligheden:

- Gebruiksvriendelijke bedieningsknopen met aparte start- en stopdrukknop en aparte noodstop
- Nullastspanning.
- Degelijke boorafscherming, uitgerust met veiligheidsschakelaar
- V-snaarkap uitgerust met veiligheidsschakelaar
- Vergrendelbare hoofdschakelaar

Order nr.		713020281 ^M	713020283 ^M
Orig. nr.		B28H 230V	B28H 400V
Spanning	V	1x230	3x400
Vermogen motor	kW	0,850	0,850
Boorcap. in staal S235JR	mm	28	28
Boorcapaciteit bij continu gebruik S235JR	mm	24	24
Spilopname	MK	3	3
Aantal snelheden		16	16
Spindeltoerental	min-1	120-4000	120-4000
Boordiepte	mm	105	105
Uitlading	mm	200	200
Diameter kolom	mm	92	92
Afmetingen tafel (b x d)	mm	340x360	340x360
T-gleuven	mm	14	14
Draaibaarheid boortafel	°	360	360
Afstand spindel-tafel	mm	860	860
Afstand spindel-voet	mm	1275	1275
Afmetingen voet (b x d)	mm	320x320	320x320
T-gleuven voet	mm	14	14
Gewicht	kg	140,00	140,00
Afmetingen (l x b x h)	mm	698 x 449 x 1721	698 x 449 x 1721
Prijs	€	1.545,00	1.499,00

B28H



7M Kwaliteitsriemen

OPTIONELE SCHUINSTELBARE BOORTAFEL - p. 971

- Aparte noodstop



ACCESSOIRES

p. 1078-1151

T40KO

MK3

0,85KW

- Links/rechts draaiend
- Rondloop nauwkeurigheid beter dan 0,015 mm
- Stalen handgrepen
- Ingebouwde machineverlichting

- Zware tussentafel met diagonaal patroon T-gleuven

- Kolom Ø 92 mm

- T-gleuven in bodemplaat

- Tot 4000 tpm



Standaard geleverd met:

- Optimum snelspan boorkop 1 -16 mm B16
- Kegeldoorn volgens DIN228 MK3/B16
- 2 T-moeren voor T-gleuf 14 mm en draad M12.
- Nederlandstalige handleiding, opschriften, CE - kenmerk, en CE-attest volgens Machine richtlijn 2006/42/CE, Laagspanningsrichtlijn 2006/95/CE en EMC Richtlijn 2004/108/CE



Professionele kolomboormachine met riem / snaaraandrijving voor de iedere werkplaats of opleidingscentra.

Troeven:

- Boren in staal tot 34 mm
- Opname morse konus MK4
- 2 x 9 snelheden
- Krachtige tweesnelheidsmotor 1,5 / 2,2 kW
- Digitale LED display voor de spilsnelheden
- Digitale boordiepte instelling
- Links-rechtsdraaiend
- Ingebouwde machineverlichting
- Machine volledig gemonteerd

Geschikt voor :

- Iedere werkplaats, onderhoudsdiensten, scholen en opleidingscentra

Kenmerken:

- Gegarandeerde rondloopnauwkeurigheid **beter dan 0,015 mm** gemeten in de boorspindel
- Spil met precisie kogellagering
- Rustigere loop door aluminium riemschijven
- Door de getande kwaliteitsaandrijfriemen verkrijgt de machine een aanzienlijk betere krachtoverbrenging en beduidend minder prestatieverlies. 7M industriële V-riem, gegarandeerde levensduur van de riem tot 10.000 werkuren
- Boordiepte aanslag
- Zware, precies bewerkte werktafel met T-gleuven in diagonaalpatroon en 360° draaibaar rond de kolom, voorzien van dubbele klemming. D.m.v. van een brede tandlat wordt de tafel eenvoudig in de hoogte vasteld
- Stalen stervormige handgreep uit 3 stukken
- Eenvoudigere gereedschapswissel door automatische booruitdrijver
- Massieve, grote bodemplaat met T-gleuven
- 3x220V model enkel mogelijk met transformator

Veiligheden:

- Gebruiksvriendelijke bedieningsknopen met aparte start- en stopdrukknop en aparte noodstop
- Nullastspanning
- Degelijke boorafscherming, uitgerust met veiligheidsschakelaar
- V-snaarkap uitgerust met veiligheidsschakelaar
- Vergrendelbare hoofdschakelaar

Order nr.	713020333	
Orig. nr.		B34H
Spanning	V	3x400
Vermogen motor	kW	1,5 / 2,2
Boorcap. in staal S235JR	mm	34
Spilopname	MK	4
Aantal snelheden		2x9
Spindeltoerental	min-1	145-4800
Boordiepte	mm	160
Uitlading	mm	285
Diameter kolom	mm	115
Afmetingen tafel (b x d)	mm	420x400
T-gleuven	mm	14
Draaibaarheid boortafel	°	360
Afstand spindel-tafel	mm	790
Afstand spindel-voet	mm	1025
Afmetingen voet (b x d)	mm	390x370
T-gleuven voet	mm	16
Gewicht	kg	274,00
Afmetingen (l x b x h)	mm	918 x 585 x 2130
Prijs	€	2.409,00

B34H

- Digitale LED display spilsnelheden
- Links/rechts draaiend
- Digitale diepteweergave



- Ingebouwde machinelamp

- Grote werktafel met boorgat

- Stevige precisie tandlat

- Massieve bodemplaat met T-gleuven

ACCESSOIRES
p. 1078-1151

1,5KW/2,3KW

MK4



Standaard geleverd met:

- Optimum snelspan boorkop 1 -16 mm B16
- Kegeldoorn volgens DIN228 MK4/B16
- 2 T-moeren voor T-gleuf 14 mm en draad M12.
- Nederlandstalige handleiding, opschriften, CE - kenmerk, en CE-attest volgens Machine richtlijn 2006/42/CE, Laagspanningsrichtlijn 2006/95/CE en EMC Richtlijn 2004/108/CE

MACHINES

OPTI



Optionele schuinstelbare boortafel.

Kenmerken:

- 360° draaibaar rond kolom
- 360° schuinstelbaar rond as
- Diagonale T-gleuven
- Robuuste werktafel

Order nr.	790023123 M	790023124 M	790023125 M
Orig. nr.	SBT24	SBT28	SBT34
Voor model	B24H - B24HV - DH24BV	B28H - B28HV - DH28V - DH28GS	B34H - B34HV - DH32GS - B40E
Gewicht	kg 15,00	20,00	35,00
Prijs	€ 264,00	299,00	437,00

Kolomboormachines Vario



Professionele kolomboormachine met riem / snaaraandrijving met variabele, traploos regelbare spijlsnelheden tot 5.600 tpm voor de betere werkplaats of opleidingscentra.

Troeven:

- Boren in staal tot 28 mm
- Opname morse konus MK3
- 12 snelheden (traploos)
- Krachtige motor 1,5 kW
- Links-rechtsdraaiend
- **Digitale LED display** voor de spijlsnelheden
- Gesloten koelvloeistofsysteem met **koelpomp en EMC spanenfilter**
- Ingebouwde machineverlichting
- Machine volledig gemonteerd

Geschikt voor:

- Werkplaatsen, onderhoudsdiensten, scholen en opleidingscentra

Kenmerken:

- Gegarandeerde rondlooppauwkeurigheid **beter dan 0,015 mm** gemeten in de boorspindel
- Spil met precisie kogellagering
- Rustigere loop door aluminium riemschijven
- Door de getande kwaliteitsaandrijfriemen verkrijgt de machine een aanzienlijk betere krachtoverbrenging en beduidend minder prestatieverlies. 7M industriële V-riem, gegarandeerde levensduur van de riem tot 10.000 werkuren
- Boordiepte aanslag
- Zware, precies bewerkte werktafel met T-gleuven in diagonaalpatroon en 360° draaibaar rond de kolom, voorzien van dubbele klemming. D.m.v. van een brede tandlat wordt de tafel eenvoudig in de hoogte vasteld
- Stalen stervormige handgreep uit 3 stukken
- Eenvoudigere gereedschapswissel door automatische booruitdrijver
- Massieve, grote bodemplaat met T-gleuven

Veiligheden:

- Gebruiksvriendelijke bedieningsknoppen met aparte start- en stopdrukknop en aparte noodstop
- Nullastspanning
- Degelijke boorafscherming, uitgerust met veiligheidsschakelaar
- V-snaarkap uitgerust met veiligheidsschakelaar
- Vergelbare hoofschakelaar

Order nr.	713020285	
Orig. nr.		B28HV
Spanning	V	1x230
Vermogen motor	kW	1,5
Boorcap. in staal S235JR	mm	28
Boorcapaciteit bij continu gebruik S235JR	mm	24
Spilopname	MK	3
Aantal snelheden		12 (traploos)
Spindeltoerental	min-1	35-5600
Boordiepte	mm	105
Uitlading	mm	200
Diameter kolom	mm	92
Afmetingen tafel (b x d)	mm	340x360
T-gleuven	mm	14
Draaibaarheid boortafel	°	360
Afstand spindel-tafel	mm	860
Afstand spindel-voet	mm	1275
Afmetingen voet (b x d)	mm	320x320
T-gleuven voet	mm	14
Gewicht	kg	141,00
Afmetingen (l x b x h)	mm	701 x 474 x 1755
Prijs	€	2.875,00

B28HV



7M Kwaliteitsriemen

OPTIONELE SCHUINSTELBARE
BOORTAFEL - p. 971



MK3



1,5KW

VARIO

- Digitale LED display
spijsnelheden

- Links/rechts
draaiend

- Potentiometer

- Machineverlichting

- Booraafscherming
met microscharrelaar

- Brede tandlat

- Massieve
werktafel

- Koelpomp

- Spanenfilter



Standaard geleverd met:

- Optimum snelspan boorkop 1 -16 mm B16
- Kegeldoorn volgens DIN228 MK3/B16
- 2 T-moeren voor T-gleuf 14 mm en draad M12.
- Nederlandstalige handleiding, opschriften, CE - kenmerk, en CE-attest volgens Machine richtlijn 2006/42/CE, Laagspanningsrichtlijn 2006/95/CE en EMC Richtlijn 2004/108/CE



Professionele kolomboormachine met riem / snaaraandrijving en variabele, traploos regelbare spijnsnelheden tot 5.000 tpm voor de betere werkplaats of opleidingscentra.

Troeven:

- Boren in staal tot 34 mm
- Opname morse konus MK4
- Variabele toerentalregeling (9 traps)
- Krachtige motor 2,2 kW
- Digitale LED display voor de spijnsnelheden
- Digitale boordiepte instelling
- Gesloten koelvloeistofsysteem met **koelpomp en EMC spanenfilter**
- Geïntegreerde **tapcyclus**
- Ingebouwde machineverlichting
- Machine volledig gemonteerd

Geschikt voor:

- Werkplaatsen, onderhoudsdiensten, scholen en opleidingcentra

Kenmerken:

- Gegarandeerde rondloopnauwkeurigheid **beter dan 0,015 mm** gemeten in de boorspindel
- Spil met precisie kogellagering
- Rustigere loop door aluminium riemschijven
- Door de getande kwaliteitsaandrijfriemen verkrijgt de machine een aanzienlijk betere krachtoverbrenging en beduidend minder prestatieverlies. 7M industriële V-riem, gegarandeerde levensduur van de riem tot 10.000 werkuren
- Boordiepte aanslag
- Zware, precies bewerkte werktafel met T-gleuven in diagonaalpatroon en 360° draaibaar rond de kolom, voorzien van dubbele klemming. D.m.v. van een brede tandlat wordt de tafel eenvoudig in de hoogte vasteld
- Stalen stervormige handgreep uit 3 stukken
- Eenvoudigere gereedschapswissel door automatische booruitdrijver
- Massieve, grote bodemplaat met T-gleuven
- **Keuzeschakelaar 4 standen** - linksdraaiend - rechtdraaiend - Auto ON/OFF (automatisch spindel activatie bij het trekken aan de hendel en uitschakeling bij het loslaten) - tapfunctie (rechtsdraaiend tot op een bepaalde vooraf ingestelde diepte om vervolgens automatisch linksdraaiend terug te keren)

Veiligheden:

- Gebruiksvriendelijke bedieningsknopen met aparte start- en stopdrukknop en aparte noodstop
- Nullastspanning
- Degelijke boorafscherming, uitgerust met veiligheidsschakelaar
- V-snaarkap uitgerust met veiligheidsschakelaar
- Vergendelbare hoofdschakelaar

Order nr.	713020335	
Orig. nr.		B34HV
Spanning	V	1x230
Vermogen motor	kW	2,2
Boorcap. in staal S235JR	mm	34
Spilopname	MK	4
Aantal snelheden		9 (vario)
Spindeltoerental	min-1	40-5000
Boordiepte	mm	160
Uitlading	mm	285
Diameter kolom	mm	115
Afmetingen tafel (b x d)	mm	420x400
T-gleuven	mm	14
Draaibaarheid boortafel	°	360
Afstand spindel-tafel	mm	790
Afstand spindel-voet	mm	1025
Afmetingen voet (b x d)	mm	390x390
T-gleuven voet	mm	16
Gewicht	kg	290,00
Afmetingen (l x b x h)	mm	860 x 595 x 2150
Prijs	€	3.405,00

B34HV



7M Kwaliteitsriemen

-  MK4
-  2,2KW
-  VARIO

- Digitale LED display spijlsnelheden
- Digitale weergave diepteinstellingen

- Potentiometer
- Ingebouwde machineverlichting

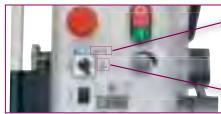

- Automatische cyclus
- Tapfunctie

OPTIONELE SCHUINSTELBARE BOORTAFEL - p. 971



- Grote werktafel met boorgat
- Koelpomp
- Spanenfilter

MACHINES

Standaard geleverd met:

- Optimum snelspan boorkop 1 -16 mm B16
- Kegeldoorn volgens DIN228 MK4/B16
- 2 T-moeren voor T-gleuf 14 mm en draad M12
- Nederlandstalige handleiding, opschriften, CE - kenmerk, en CE-attest volgens Machine richtlijn 2006/42/CE, Laagspanningsrichtlijn 2006/95/CE en EMC Richtlijn 2004/108/CE



Professionele kolomboormachine met variabele toerentalregeling.

Troeven:

- Boren in staal tot 28 mm
- Opname morse konus MK3
- **Duitse Variomatic variabele toerentalregeling mechanisch systeem, niet langer snaren / riemen verleggen**
- Digitale LED snelheidsweergave
- Machineverlichting
- Krachtige tweesneldheidsmotor 0,85 / 1,5 kW
- Links-rechtsdraaiend
- Machine volledig gemonteerd

Geschikt voor:

- betere werkplaats, onderhoudsdienst, scholen en opleidingcentra, algemene industrie
- het verwerken van verschillende soorten materialen

Kenmerken:

- Gegarandeerde rondloopnauwkeurigheid **beter dan 0.015 mm** gemeten in de boorspindel
- Lange ergonomische handgrepen uit staal
- Spil met precisie kogellagering
- Boordiepte aanslag
- 7M industriële V-riem, gegarandeerde levensduur van de riem tot 10.000 werkuren
- Zware, precies bewerkte werktafel met T-gleuven in diagonaalpatroon en 360° draaibaar rond de kolom, voorzien van dubbele klemming. D.m.v. van een brede tandlat wordt de tafel eenvoudig in de hoogte versteld
- Eenvoudige gereedschapswissel door automatische uitdrijver
- Massieve, grote bodemplaat met T-gleuven.
- 3x220V model enkel mogelijk met transformator

Veiligheden:

- Gebruiksvriendelijke bedieningsknoppen met aparte start- en stopdrukknop en aparte noodstop
- Nullastspanning
- Degelijke booraafscherming, uitgerust met veiligheidsschakelaar
- V-snaarkap uitgerust met veiligheidsschakelaar
- Vergenelbare hoofdschakelaar

Order nr.	713020430	
Orig. nr.	DH28BV 400V	
Spanning	V	400
Vermogen motor	kW	0,85/1,5
Boorcap. in staal S235JR	mm	28
Boorcapaciteit bij continu gebruik S235JR	mm	24
Spilopname	MK	3
Aantal trappen		2
Spindeltoerental	min-1	300 - 4.000
Boordiepte	mm	105
Uitlading	mm	200
Afmetingen tafel (b x d)	mm	340x360
T-gleuven	mm	14
Afstand spindelvoet	mm	1275
Afmetingen voet (b x d)	mm	320x320
Gewicht	kg	160,00
Afmetingen (l x b x h)	mm	701 x 474 x 1780
Prijs	€	2.429,00



 Duits Vario mechanisme systeem

Traploos instelbare overbrenging

- Zeer betrouwbaar door manuele snelheidsverstelling
- Krachtige stille werking
- Duurzame V-snaren
- Snelheidsverandering terwijl de machine draait



0,85KW/1,5KW



MK3



VARIO



- Vergrendelbare hoofdschakelaar
- Mechanische snelheidsregeling

- Digitale LED weergave spijlsnelheden

- Aparte start/stop/noodstop
- Links/rechts draaiend

- Tot 4000 tpm

- Booraafscherm met microscharrelaar

Standaard geleverd met:

- Optimum snelspan boorkop 1-16 mm B16
- Kegeldoorn volgens DIN228 MK3/B16
- 2 T-moeren voor T-gleuf 14 mm en draad M12.
- Nederlandstalige handleiding, opschriften, CE - kenmerk, en CE-attest volgens Machine richtlijn 2006/42/CE, Laagspanningsrichtlijn 2006/95/CE en EMC Richtlijn 2004/108/CE



Professionele kolomboormachine met variabele toerentalregeling.

Troeven:

- Boren in staal tot 34 mm
- Opname morse konus MK4
- **Duitse Variomatic variabele toerentalregeling mechanisch systeem, niet langer snaren / riemen verleggen**
- Digitale LED snelheidsweergave
- Digitale boordiepteweergave
- Machineverlichting
- Krachtige tweesneldheidsmotor 1,5 / 2,4 kW
- Links-rechtsdraaiend
- Machine volledig gemonteerd

Geschikt voor:

- betere werkplaats, onderhoudsdienst, scholen en opleidingcentra, algemene industrie
- het verwerken van verschillende soorten materialen

Kenmerken:

- Gegarandeerde rondlooptrouwbaarheid **beter dan 0,015 mm** gemeten in de boorspindel
- Lange, ergonomische stalen handgrepen
- Spil met precisie kogellagering
- 7M industriële V-riem, gegarandeerde levensduur van de riem tot 10.000 werkuren
- Zware, precies bewerkte werktafel met T-gleuven in diagonaalpatroon en 360° draaibaar rond de kolom, voorzien van dubbele klemming. D.m.v. van een brede tandlat wordt de tafel eenvoudig in de hoogte versteld
- Eenvoudige gereedschapswissel door automatische uitdrijver
- Massieve, grote bodemplaat met T-gleuven
- 3x220V model enkel mogelijk met transformator

Veiligheden:

- Gebruiksvriendelijke bedieningsknoppen met aparte start- en stopdrukknop en aparte noodstop
- Nullastspanning
- Degelijke boorafscherming, uitgerust met veiligheidsschakelaar
- V-snaarkap uitgerust met veiligheidsschakelaar
- Vergendelbare hoofdschakelaar

Order nr.		713020440
Orig. nr.		DH34BV 400V
Spanning	V	400
Vermogen motor	kW	1,5/2,4
Boorcap. in staal S235JR	mm	34
Boorcapaciteit bij continu gebruik S235JR	mm	26
Spilopname	MK	4
Aantal trappen		2
Spindeltoerental	min-1	300 - 4.000
Boordiepte	mm	160
Uitlading	mm	285
Afmetingen tafel (b x d)	mm	420x400
T-gleuven	mm	14
Afstand spindelvoet	mm	1025
Afmetingen voet (b x d)	mm	390x390
Gewicht	kg	270,00
Afmetingen (l x b x h)	mm	918 x 595 x 1960
Prijs	€	3.219,00



$n_{const} = n_2$

 Duits Vario
mechanisme systeem

Traploos instelbare overbrenging

- Zeer betrouwbaar door manuele snelheidsverstelling
- Krachtige stille werking
- Duurzame V-snaren
- Snelheidsverandering terwijl de machine draait



1,5KW/2,4KW

gsm

MK4

VARIO

VARIO

- 
- Digitale LED display spilsnelheden
 - Digitale boordiepte weergave
 - Boorafscherming met microscharakelaar
 - 4 stalen handgrepen
 - Ingebouwde machineverlichting
 - Stevige werktafel met boorgat
 - Massieve bodemplaat

Standaard geleverd met:

- Optimum snelspan boorkop 1-16 mm B16
- Kegeldoorn volgens DIN228 MK4/B16
- 2 T-moeren voor T-gleuf 14 mm en draad M12
- Nederlandstalige handleiding, opschriften, CE - kenmerk, en CE-attest volgens Machine richtlijn 2006/42/CE, Laagspanningsrichtlijn 2006/95/CE en EMC Richtlijn 2004/108/CE



Tandwiel aangedreven kolomboormachine met variabele toerentalregeling (400 V).

Troeven:

- Boren in staal tot 32 mm
- Opname morse konus MK4
- Tandwieloverbrenging
- **Traploos regelbare toerentalregeling** 40 - 3.000 tpm, met potentiometer, koppel in het laagste toerental bedraagt tot 200 Nm
- Elektromagnetische boorvoeding, met 3 voedingen **0,1, 0,15 en 0,20 mm/omw**
- Digitale weergave van de snelheden
- Geïntegreerde tapfunctie
- Gesloten koelvloeistofsysteem met koelpomp en spanenfilter volgens de machine richtlijn.
- Geïntegreerde machineverlichting in de boorkop
- Machine volledig gemonteerd

Geschikt voor:

- Iedere werkplaats, onderhoudsdienst, scholen en opleidingcentra, algemene industrie
- Het verwerken van verschillende soorten materialen

Kenmerken:

- Zware, massieve gietijzeren uitvoering
- Onderhoudsarme aandrijving met vetsmering
- Krachtige, stille motor
- Gebruiksvriendelijke bedieningsknopen, spatwaterdicht
- Geluidsarme loop dankzij geslepen meenemer met multivertanding
- Precieze omlooptrouwkeurigheid spindel en een lange levensduur door geharde en geslepen spindel
- Gietijzeren dikwandige kolom voor grote krachtopnames en stabiliteit
- Rechts / links draairichting
- Eenvoudige gereedschapswissel door automatische booruitdrijver
- Groot gedimensioneerde gietijzeren werktafel, geslepen en voorzien van T-gleuven
- Massieve, grote bodemplaat met T-gleuven
- Boordiepte instelling met millimeter schaal

Veiligheden:

- Gebruiksvriendelijke bedieningsknopen met aparte start- en stopdrukknop en aparte noodstop
- Nullastspanning
- Vergenelbare hoofdschakelaar
- Degelijke boorafscherming met microscharnelaar, boormachine valt onmiddellijk stil bij het openen van de afscherming

Order nr.		713034245
Orig. nr.		DH32GSV 400V
Spanning	V	3x400
Vermogen motor	kW	2,2
Boorcap. in staal S235JR	mm	32
Boorcapaciteit bij continu gebruik S235JR	mm	28
Spilopname	MK	4
Uitlading	mm	285
Aantal snelheden		Vario (4)
Spindeltoerental	min-1	40 - 3000
Boordiepte	mm	125
Aantal boorvoedingen		3
Automatische boorvoedingen	mm	0,1 / 0,15 / 0,2
Diameter kolom	mm	115
Afstand spindel-tafel	mm	Max. 820
Afmetingen tafel (b x d)	mm	400x420
T-gleuven	mm	14
Draaibaarheid boortafel	°	360
Afstand spindel-voet	mm	Max. 1280
Afmetingen voet (b x d)	mm	420x480
Gewicht	kg	300,00
Afmetingen (l x b x h)	mm	725 x 450 x 2200
Prijs	€	4.115,00

DH32GSV

NEW



- Digitale LED display spijlsnelheden
- Links/rechts draaiend
- Tapcyclus
- Potentiometer

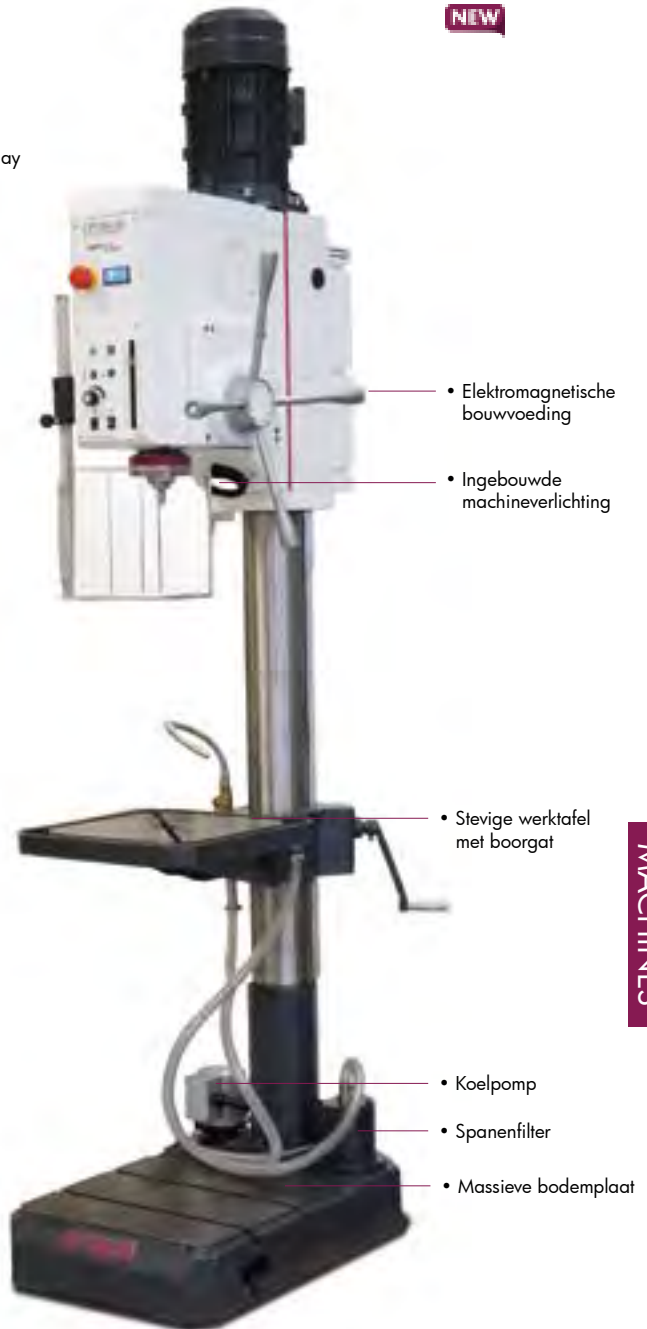

- Elektromagnetische bouwvoeding
- Ingebouwde machineverlichting
- Stevige werktafel met boorgat
- Koelpomp
- Spanenfilter
- Massieve bodemplaat

VARIO

2,2KW

MK4



MACHINES

Standaard geleverd met:

- Kegeldoorn MK4 - B16
- Nederlandstalige handleiding, opschriften, CE - kenmerk, en CE-attest volgens Machine richtlijn 2006/42/CE, Laagspanningsrichtlijn 2006/95/CE en EMC Richtlijn 2004/108/CE

Opgepast: snelspan boorkop (713050574) is niet inbegrepen.

Kolomboormachines tandwielaangedreven



Tandwiel aangedreven kolomboormachine voor montagebedrijven en de algemene industrie.

Troeven:

- Boren in staal tot 28 mm
- Opname morse konus MK3
- Tandwieloverbrenging
- Rechts / links draairichting
- Geïntegreerde machineverlichting in de boorkop
- Machine volledig gemonteerd

Geschikt voor:

- Iedere werkplaats, montagebedrijven, onderhoudsdiensten, scholen en opleidingcentra, algemene industrie

Kenmerken:

- Zware, massieve gietijzeren uitvoering
- Onderhoudsarme aandrijving met vetsmering
- Krachtige, stille 2 stappen motor
- Geluidsarme loop dankzij geslepen meenemer met multivertanding
- Precieze omloopnauwkeurigheid spindel en een lange levensduur door geharde en geslepen spindel
- Gietijzeren dikwandige kolom voor grote krachtopnames en stabiliteit
- Groot gedimensioneerde gietijzeren werktafel, geslepen en voorzien van T-gleuven
- Massieve, grote bodemplaat met T-gleuven
- Boordiepte instelling met millimeter schaal
- Snelheidsinstelling door twee keuzeschakelaars aan de linker zijkant van de boorkop
- Andere voltages: 3x220V en 3x440V op aanvraag

Veiligheden:

- Gebruiksvriendelijke bedieningsknopen met aparte start- en stopdrukknop en aparte noodstop
- Nullastspanning
- Vergenelbare hoofdschakelaar
- Degelijke boorafscherming met microscharakelaar, boormachine valt onmiddellijk stil bij het openen van de afscherming

Order nr.	713034230	
Orig. nr.		DH28GS
Spanning	V	3x400
Vermogen motor	kW	1.1/1.5
Boorcap. in staal S235JR	mm	28
Boorcapaciteit bij continu gebruik S235JR	mm	25
Spilopname	MK	3
Uitlading	mm	260
Aantal snelheden		8
Spindeltoerental	min-1	75-2900
Boordiepte	mm	127
Diameter kolom	mm	92
Afstand spindel-tafel	mm	875
Afmetingen tafel (b x d)	mm	376x394
T-gleuven	mm	14
Draaibaarheid boortafel	°	360
Afstand spindel-voet	mm	1200
Afmetingen voet (b x d)	mm	350x356
T-gleuven voet	mm	14
Gewicht	kg	184,00
Afmetingen (l x b x h)	mm	670 x 550 x 2080
Prijs	€	2.525,00

DH28GS

ACCESSOIRES
p. 1078-1151

1,1KW/1,5KW

MK3

184KO

90

1

**OPTIONELE SCHUINSTELBARE
BOORTAFEL** - p. 971

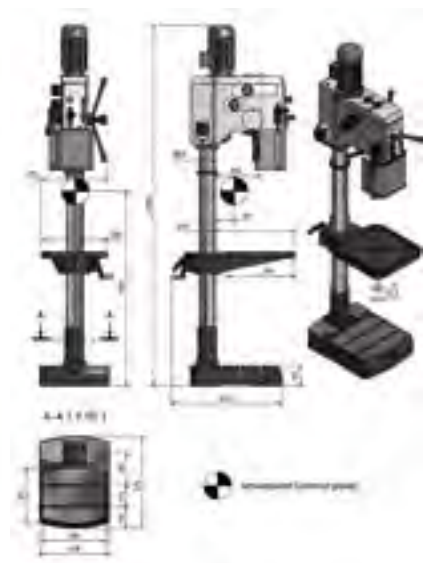

MACHINES

Standaard geleverd met:

- Kegeldoorn MK3 - B16
- Nederlandstalige handleiding, opschriften, CE - kenmerk, en CE-attest volgens Machine richtlijn 2006/42/CE, Laagspanningsrichtlijn 2006/95/CE en EMC Richtlijn 2004/108/CE

Opgepast: snelspan boorkop is NIET inbegrepen.



Tandwiel aangedreven kolomboormachine voor montagebedrijven en de algemene industrie

Troeven:

- Boren in staal tot 32 mm
- Opname morse konus MK4
- Tandwieloverbrenging
- Elektromagnetische boorvoeding, met 3 voedingen **0,1, 0,15 en 0,20 mm/omw.**
- Geïntegreerde tapfunctie
- Gesloten koelvloeistofstelsysteem met koelpomp en spanenfilter volgens de machine richtlijn.
- Geïntegreerde machineverlichting in de boorkop
- Machine volledig gemonteerd

Geschikt voor:

- betere werkplaats, onderhoudsdienst, scholen en opleidingcentra, algemene industrie

Kenmerken:

- Zware, massieve gietijzeren uitvoering
- Onderhoudsarme aandrijving met vetsmering
- Krachtige, stille 2 stappen motor
- Geluidsarme loop dankzij geslepen meenemer met multivertanding
- Precieze omloopnauwkeurigheid spindel en een lange levensduur door geharde en geslepen spindel
- Gietijzeren dikwandige kolom voor grote krachtopnames en stabiliteit
- Groot gedimensioneerde gietijzeren werktafel, geslepen en voorzien van T-gleuven
- Massieve, grote bodemplaat met T-gleuven
- Boordiepte instelling met millimeter schaal
- Snelheidsinstelling door twee keuzeschakelaars aan de linker zijkant van de boorkop
- Andere voltages: 3x220V en 3x440V op aanvraag

Veiligheden:

- Gebruiksvriendelijke bedieningsknoppen met aparte start- en stopdrukknop en aparte noodstop
- Nullastspanning
- Vergenelbare hoofdschakelaar
- Degelijke boorafscherming met microschakelaar, boormachine valt onmiddellijk stil bij het openen van de afscherming

Order nr.	713034240	
Orig. nr.		DH32GS
Spanning	V	3x400
Vermogen motor	kW	1.5/2.2
Boorcap. in staal S235JR	mm	32
Boorcapaciteit bij continu gebruik S235JR	mm	29
Spilopname	MK	4
Uitlading	mm	285
Aantal snelheden		8
Spindeltoerental	min-1	75-2000
Boordiepte	mm	125
Aantal boorvoedingen		3
Automatische boorvoedingen	mm	0,10-0,15-0,20
Diameter kolom	mm	115
Afstand spindel-tafel	mm	820
Afmetingen tafel (b x d)	mm	400x420
T-gleuven	mm	14
Draaibaarheid boortafel	°	360
Afstand spindel-voet	mm	1280
Afmetingen voet (b x d)	mm	420x644
T-gleuven voet	mm	14
Gewicht	kg	295,00
Afmetingen (l x b x h)	mm	725 x 450 x 2200
Prijs	€	3.295,00

DH32GS



3 boorvoedingen
Geïntegreerde booruitwerper

ACCESSOIRES

p. 1078-1151

1,5KW/2,2KW



295KG



- Aparte noodstop
- Links/rechts draaiend
- Optionele boorkop
- Afscherming met microscharakelaar
- Krachtige, stille 2 stappen motor
- 4-voudige ergonomisch spaakwiel
- Elektromagnetische voeding

OPTIONELE SCHUINSTELBARE BOORTAFEL - p. 971

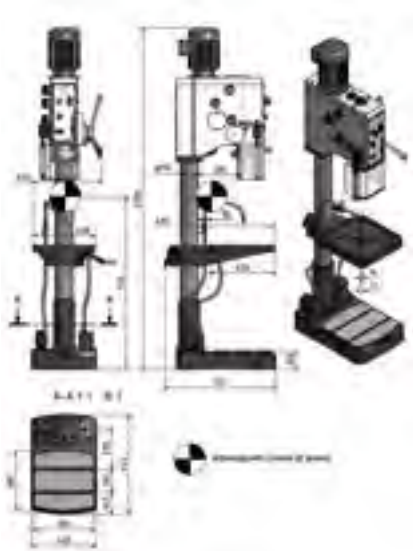

- Gietijzeren dikwandige kolom
- Groot gedimensioneerde werktafel over tandlat
- Gesloten koelvloeistof systeem met pomp
- Spanenfilter volgens machinerichtlijn

MACHINES

Standaard geleverd met:

- Kegeldoorn MK4 - B16
- Nederlandstalige handleiding, opschriften, CE - kenmerk, en CE-attest volgens Machine richtlijn 2006/42/CE, Laagspanningsrichtlijn 2006/95/CE en EMC Richtlijn 2004/108/CE

Opgepast: snelspan boorkop is NIET inbegrepen



Tandwiel aangedreven kolomboorfreemACHINE voor montagebedrijven en de algemene industrie

Troeven:

- Boren in staal tot 32 mm
- Opname morse konus 4 met aantrekdraad M16, mogelijk om te frezen
- Tandwieloverbrenging in een oliebad gesmeerd
- 2 x 6 spilsnelheden
- **In de hoogte verstelbare boorkop en schuinstelbare boorkop**
- Gesloten koelvloeistofsysteem met koelpomp en spanenfilter volgens de machine richtlijn.
- Machine volledig gemonteerd

Geschikt voor:

- Iedere werkplaats, montagebedrijven, onderhoudsdienst, scholen en opleidingcentra, algemene industrie

Kenmerken:

- Krachtige, stille 2 stappen motoren
- Spil met precisie kogellagering
- Precieze omloopnauwkeurigheid spindel
- Stabiliteit gegarandeerd door een zwaar gedimensioneerde, dikwandige stalen kolom \varnothing 115 mm
- Rechts / links draairichting
- Groot gedimensioneerde gietijzeren werktafel, geslepen en voorzien van T-gleuven
- Hoogteverstelling werktafel via tandlat
- Massieve, grote bodemplaat met T-gleuven
- In de hoogte verstelbare en verdraaibare boorkop via degelijke tandlat en voorzien van sterke klemming
- Boorkop is eveneens links en rechts instelbaar tot 60°
- Boordiepte instelling met millimeter schaal
- Stalen handgreep uit drie stukken
- Handwiel voor fijne manuele voeding
- Snelheidsinstelling door twee schakelhendels aan de voorkant van de boorkop
- Andere voltages: 3 x 220 V en 3 x 440 V op aanvraag

Veiligheden:

- Gebruiksvriendelijke bedieningsknopen met aparte start- en stopdrukknop en aparte noodstop
- Nullastspanning
- Vergenelbare hoofdschakelaar
- Degelijke booraafscherming met microschakelaar, boormACHINE valt onmiddellijk stil bij het openen van de afscherming

Order nr.	713034340	
Orig. nr.		B40E
Spanning	V	3x400
Vermogen motor	kW	1,1-1,5
Boorcap. in staal S235JR	mm	32
Boorcapaciteit bij continu gebruik S235JR	mm	25
Spilopname	MK	4/M16
Uitlading	mm	285
Aantal snelheden		12
Spindeltoerental	min-1	95-3200
Boordiepte	mm	120
Diameter kolom	mm	115
Afstand spindel-tafel	mm	855
Afmetingen tafel (b x d)	mm	425x420
T-gleuven	mm	14
Draaibaarheid boortafel	°	360
Afstand spindel-voet	mm	1215
Afmetingen voet (b x d)	mm	385x385
T-gleuven voet	mm	16
Gewicht	kg	322,00
Afmetingen (l x b x h)	mm	700 x 600 x 2050
Prijs	€	3.125,00

ACCESSOIRES
 p. 1078-1151

1,1KW/1,5KW

MK4/M16

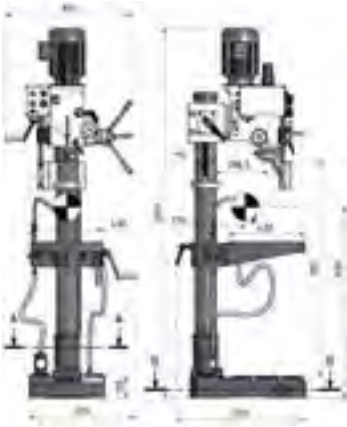
**OPTIONELE SCHUINSTELBARE
 BOORTAFEL** - p. 971

• Bediening vooraan



• Smering in oliebad

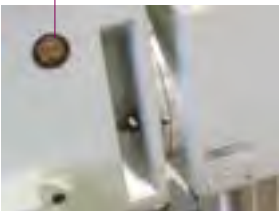

• Boorkop links/rechts instelbaar 60°

 • Met aantrekkstang voor
 freesbewegingen

• Aparte noodstop

 • Boorafscherming met
 microscharrelaar

 • Gesloten koelstroom-
 systeem met koelpomp

 • In de hoogte verstelbare
 boor(frees)kop

• 180° zwenkbare boorkop

• Oliepeilglas

 • Dikwandige gietijzeren
 kolom Ø 115

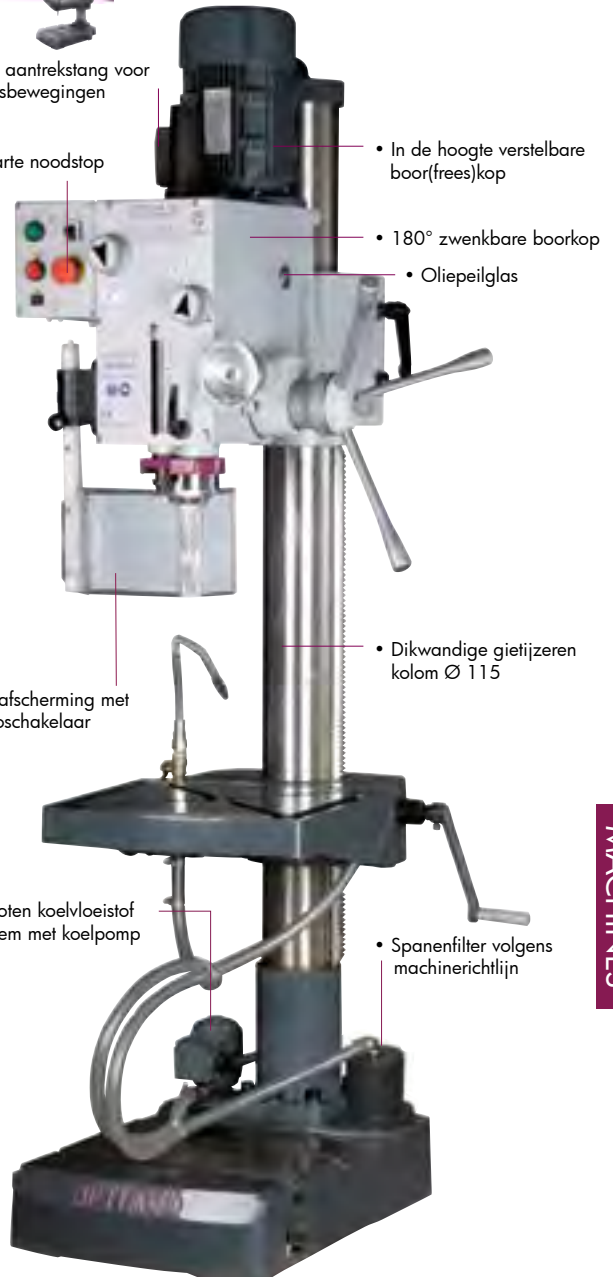
 • Spanenfilter volgens
 machinerichtlijn

Standaard geleverd met:

- Tandkrans boorkop 1-16 mm B16
- Kegeldoorn MK4/M16 B16
- Nederlandstalige handleiding, opschriften, CE - kenmerk, en CE-attest volgens Machine richtlijn 2006/42/CE, Laagspanningsrichtlijn 2006/95/CE en EMC Richtlijn 2004/108/CE

Opgepast: machine niet afgevuld met tandwielolie, vergeet deze niet bij te bestellen, Helios 5, 790030020



Tandwiel aangedreven kolomboorfreemACHINE voor montagebedrijven en de algemene industrie.

Troeven:

- Boren in staal tot 32 mm
- Opname morse konus 4 met aantrekdraad M16, mogelijk om te frezen
- Tandwieloverbrenging in een oliebad gesmeerd
- Mechanische automatische boorvoedingen (3) (St.37) : 0,1 / 0,18 / 0,26 mm/omw
- 2 x 6 spilsnelheden
- In de hoogte verstelbare boorkop en schuinstelbare boorkop
- Gesloten koelvloeistofsystem met koelpomp en spanenfilter volgens de machine richtlijn.
- Schuinstelbare tussentafel
- Machine volledig gemonteerd

Geschikt voor:

- Iedere werkplaats, montagebedrijven, onderhoudsdienst, scholen en opleidingcentra, algemene industrie

Kenmerken:

- Krachtige, stille 2 stappen motoren
- Spil met precisie kogellagering
- Precieze omloopnauwkeurigheid spindel
- Stabiliteit gegarandeerd door een zwaar gedimensioneerde, dikwandige stalen kolom ø 115 mm
- Rechts / links draairichting
- Groot gedimensioneerde gietijzeren werktafel, geslepen en voorzien van T-gleuven
- Hoogteverstelling werktafel via tandlat
- Massieve, grote bodemplaat met T-gleuven
- In de hoogte verstelbare en verdraaibare boorkop via degelijke tandlat en voorzien van sterke klemming
- Boorkop is eveneens links en rechts instelbaar tot 60°
- Boordiepte instelling met millimeter schaal
- Stalen handgreep uit drie stukken
- Handwiel voor fijne manuele voeding
- Snelheidsinstelling door twee schakelhendels aan de voorkant van de boorkop
- Andere voltages: 3 x 220 V en 3 x 440 V op aanvraag

Veiligheden:

- Gebruiksvriendelijke bedieningsknoppen met aparte start- en stopdrukknop en aparte noodstop
- Nullastspanning
- Vergenelbare hoofdschakelaar
- Degelijke booraafscherming met microschakelaar, boormACHINE valt onmiddellijk stil bij het openen van de afscherming

Order nr.	713034345	
Orig. nr.		B40PTE
Spanning	V	3x400
Vermogen motor	kW	1,1-1,5
Boorcap. in staal S235JR	mm	32
Boorcapaciteit bij continu gebruik S235JR	mm	25
Spilopname	MK	4/M16
Uitlading	mm	285
Aantal snelheden		12
Spindeltoerental	min-1	95-3200
Boordiepte	mm	120
Diameter kolom	mm	115
Afstand spindel-tafel	mm	855
Afmetingen tafel (b x d)	mm	400x445
T-gleuven	mm	14
Zwenkbaarheid boortafel	°	180
Draaibaarheid boortafel	°	360
Afstand spindel-voet	mm	1215
Afmetingen voet (b x d)	mm	385x385
T-gleuven voet	mm	16
Gewicht	kg	322,00
Afmetingen (l x b x h)	mm	720 x 700 x 2050
Prijs	€	3.465,00

ACCESSOIRES

p. 1078-1151



1,1KW/1,5KW



MK4/M16

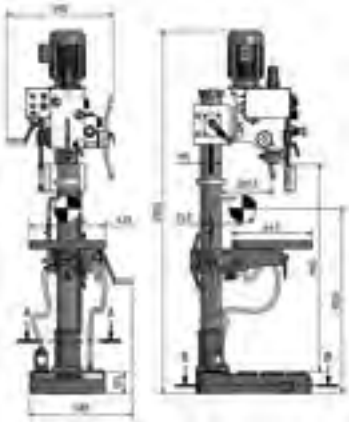

- Met aantrekstang voor freesbewerkingen
- In de hoogte verstelbare boor(frees)kop
- Olipeilglas
- 3 automatische boorvoedingen
- Fijne boorvoeding
- Dikwandige stalen kolom
- Boorafscherming met microscharakelaar
- Zwenkbare draaitafel 360° (400 x 445mm)
- Spanenfilter volgens machinerichtlijn
- Bediening vooraan
- Smering in oliebad
- Standaard koelpomp



• Smering in oliebad

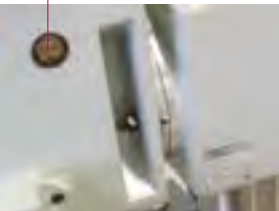

• Boorkop links-rechts instelbaar 60°

Standaard geleverd met:

- Tandkrans boorkop 1-16 mm B16
- Kegeldoorn MK4/M16 B16
- Nederlandstalige handleiding, opschriften, CE - kenmerk, en CE-attest volgens Machine richtlijn 2006/42/CE, Laagspanningsrichtlijn 2006/95/CE en EMC Richtlijn 2004/108/CE

Opgepast: machine niet afgevuld met tandwielolie, vergeet deze niet bij te bestellen, Helios 5, 790030020



Zware industriële kolomboormachines met tandwiel overbrenging en automatische mechanische voeding.

Troeven:

- Boren in staal tot 35 mm
- Opname morse konus 4
- Tandwieloverbrenging in een oliebad gesmeerd
- Mechanische automatische boorvoedingen
- 18 spilsnelheden
- Geïntegreerde tapfunctie
- Gesloten koelvloeistofsysteem met koelpomp en spanenfilter volgens de machine richtlijn.
- Grote uitlading 350 mm
- Machine volledig gemonteerd

Geschikt voor:

- Iedere werkplaats, montagebedrijven, onderhoudsdienst, scholen en opleidingscentra, algemene industrie

Kenmerken:

- Mechanische voeding, door het activeren van de voedingshendel, wordt na het bereiken van de vooraf ingestelde boordiepte, de voedingshendel mechanisch terug gedrukt door de boordiepte aanslag en wordt de automatische voeding gedeactiveerd
- 2 voedingen aanwezig (St.37) : 0,1 mm/omw. 0,2 mm/omw.
- Stille kwalitatieve elektromotoren
- Grote uitlading van 350 mm, waardoor grotere stukken kunnen worden bewerkt.
- Spil met precisie kogellagering
- Hoge rondloopnauwkeurigheid door geharde en geslepen hoofdspindel
- Tandwieloverbrenging wordt gesmeerd in een oliebad. Alle tandwielen en assen zijn geslepen en gehard
- Zware, precies bewerkte werktafel met T-gleuven in diagonaalpatroon en 360° draaibaar rond de kolom, voorzien van dubbele klemming. D.m.v. van een brede tandlat wordt de tafel eenvoudig in de hoogte versteld
- Eenvoudigere gereedschapswissel door automatische booruitdrijver
- Massieve, grote bodemplaat met T-gleuven
- Ingewerkte halogeen machineverlichting 12 V
- Tapfunctie (rechtsdraaiend tot op een bepaalde vooraf ingestelde diepte om vervolgens automatisch linksdraaiend terug te keren)
- Links- en rechtsdraaiend
- Spil oriëntatieknop voor precieze centering
- Ook verkrijgbaar in andere voltages: 3 x 220 V / 50 Hz en 3 x 440 V / 60 Hz. Opmerking: 3 x 220 V = krachtstroom (drijfkracht). Dit is niet hetzelfde als 1 x 230 V mono = wisselstroom

Veiligheden:

- Gebruiksvriendelijke bedieningsknoppen met aparte start- en stopdrukknop en aparte noodstop
- Nullastspanning
- Vergenelbare hoofdschakelaar
- Degelijke booraafscherming met microscharnelaar, boormachine valt onmiddellijk stil bij het openen van de afscherming

Order nr.	713334403	
Orig. nr.	B40GSP	
Spanning	V	3x400
Vermogen motor	kW	1,5
Boorcap. in staal S235JR	mm	35
Boorcapaciteit bij continu gebruik S235JR	mm	35
Draadsnijcapaciteit in staal S235JR	M	24
Spilopname	MK	4
Uitlading	mm	350
Aantal snelheden		18
Spindeltoerental	min-1	50-1450
Boordiepte	mm	180
Diameter kolom	mm	150
Afstand spindel-tafel	mm	780
Afmetingen tafel (b x d)	mm	560x560
T-gleuven	mm	18
Draaibaarheid boortafel	°	360
Afstand spindel-voet	mm	1320
Afmetingen voet (b x d)	mm	510x500
T-gleuven voet	mm	18
Gewicht	kg	500,00
Afmetingen (l x b x h)	mm	935 x 560 x 2280
Prijs	€	3.999,00

ACCESSOIRES

p. 1078-1151

MK4



1,5KW

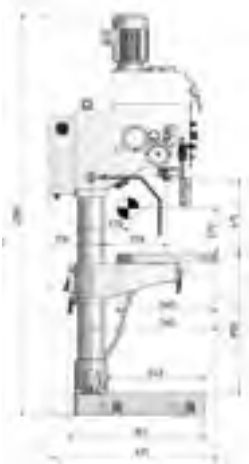

- Snelheidshendels vooraan
- Tapfunctie
- Jogfunctie
- Boordiepte aanslag met mm schaal
- Boorafscherming met microscharnelaar
- Tandwielen constant gesmeerd in oliebad
- Mechanische voeding
- Verlichting
- Kolom Ø 150 mm
- Zware gietijzeren tussentafel 560 x 560 mm
- Geïntegreerde koelpomp
- Massieve bodemplaat
- Spanenfilter volgens machinerichtlijn

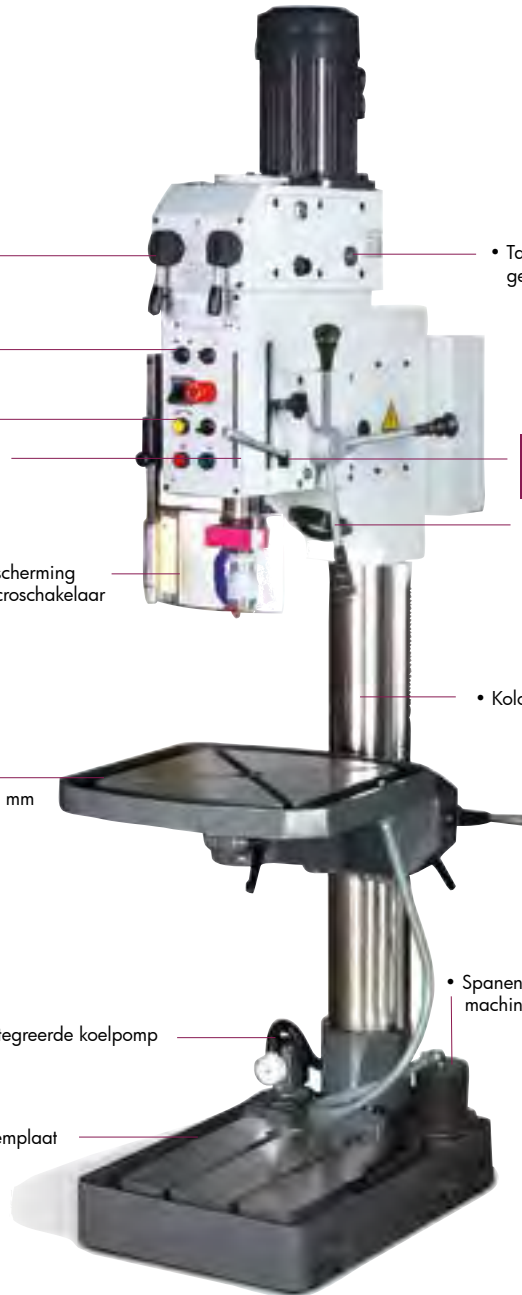
**Standaard geleverd met:**

- Optimum snelspan boorkop 1-16 mm B16
- Kegeldoorn volgens DIN228 MK4 B16
- Nederlandstalige handleiding, opschriften, CE - kenmerk, en CE-attest volgens Machine richtlijn 2006/42/CE, Laagspanningsrichtlijn 2006/95/CE en EMC Richtlijn 2004/108/CE

Opgepast: machine niet afgevuuld met tandwielolie, vergeet deze niet bij te bestellen, Helios 5, 790030020



Zware industriële kolomboormachines met tandwiel overbrenging en automatische elektromagnetische voeding.

Troeven:

- Boren in staal tot 35 mm
- Opname morse konus 4
- Tandwieloverbrenging in een oliebad gesmeerd
- **Elektromagnetische** automatische boorvoedingen
- 18 spilsnelheden
- Geïntegreerde tapfunctie
- Gesloten koelvloeistofsysteem met koelpomp en spanenfilter volgens de machine richtlijn.
- Grote uitlading 350 mm
- Machine volledig gemonteerd

Geschikt voor:

- betere werkplaats, montagebedrijven, onderhoudsdienst, scholen en opleidingscentra, algemene industrie

Kenmerken:

- Mechanische voeding, door het activeren van de voedingshendel, wordt na het bereiken van de vooraf ingestelde boordiepte, de voedingshendel mechanisch terug gedrukt door de boordiepte aanslag en wordt de automatische voeding gedeactiveerd.
- 2 voedingen aanwezig (St.37) : 0,1 mm/omw. 0,2 mm/omw.
- Stille kwalitatieve elektromotoren.
- Grote uitlading van 350 mm, waardoor grotere stukken kunnen worden bewerkt.
- Spil met precisie kogellagering.
- Hoge rondloopnauwkeurigheid door geharde en geslepen hoofdspindel.
- Tandwieloverbrenging wordt gesmeerd in een oliebad. Alle tandwielen en assen zijn geslepen en gehard.
- Zware, precies bewerkte werktafel met T-gleuven in diagonaalpatroon en 360° draaibaar rond de kolom, voorzien van dubbele klemming. D.m.v. van een brede tandlat wordt de tafel eenvoudig in de hoogte versteld.
- Eenvoudigere gereedschapswissel door automatische booruitdrijver
- Massieve, grote bodemplaat met T-gleuven.
- Ingewerkte halogeen machineverlichting 12V
- Tapfunctie (rechtsdraaiend tot op een bepaalde vooraf ingestelde diepte om vervolgens automatisch linksdraaiend terug te keren).
- Links- en rechtsdraaiend
- Spil oriëntatieknop voor precieze centrering
- Ook verkrijgbaar in andere voltages: 3x220V/50Hz en 3x440V/60Hz. Opmerking: 3x220V = krachtstroom (drijfkracht). Dit is niet hetzelfde als 1x230V mono = wisselstroom

Veiligheden:

- Gebruiksvriendelijke bedieningsknoppen met aparte start- en stopdrukknop en aparte noodstop
- Nullastspanning
- Vergenelbare hoofdschakelaar
- Degelijke booraafscherming met microscharnelaar, boormachine valt onmiddellijk stil bij het openen van de afscherming

Order nr.	713334400	
Orig. nr.	B40GSM	
Spanning	V	3x400
Vermogen motor	kW	1,5
Boorcap. in staal S235JR	mm	35
Boorcapaciteit bij continu gebruik S235JR	mm	35
Draadsnijcapaciteit in staal S235JR	M	24
Spilopname	MK	4
Uitlading	mm	350
Aantal snelheden		18
Spindeltoerental	min-1	50-1450
Boordiepte	mm	180
Diameter kolom	mm	150
Afstand spindel-tafel	mm	780
Afmetingen tafel (b x d)	mm	560x560
T-gleuven	mm	18
Draaibaarheid boortafel	°	360
Afstand spindel-voet	mm	1320
Afmetingen voet (b x d)	mm	510x500
T-gleuven voet	mm	18
Gewicht	kg	500,00
Afmetingen (l x b x h)	mm	935 x 560 x 2280
Prijs	€	4.395,00

ACCESSOIRES

p. 1078-1151

MK4



1,5KW



- Snelheidshendels vooraan
- Tapfunctie
- Boorafscherming met microscharakelaar
- Zware gietijzeren tafel
- Tandwielen constant gesmeerd in oliebad
- Elektromagnetische voeding
- Verlichting
- Aparte elektrische kast
- Dikwandige gietijzeren kolom Ø 150mm
- Geïntegreerde koelpomp
- Spanenfilter volgens machinerichtlijn



Standaard geleverd met:

- Optimum snelspan boorkop 1-16 mm B16
- Kegeldoorn volgens DIN228 MK4 B16
- Nederlandstalige handleiding, opschriften, CE - kenmerk, en CE-attest volgens Machine richtlijn 2006/42/CE, Laagspanningsrichtlijn 2006/95/CE en EMC Richtlijn 2004/108/CE.

Opgepast: machine niet afgevuld met tandwielolie, vergeet deze niet bij te bestellen, Helios 5, 790030020



“Heavy Duty” industriële kolomboormachines met tandwiel overbrenging en elektromagnetische voeding.

Troeven:

- Boren in staal tot 50 mm
- Opname morse konus 4
- Tandwieloverbrenging in een oliebad gesmeerd
- **6 Elektromagnetische** automatische boorvoedingen
- 18 spilsnelheden
- Geïntegreerde tapfunctie
- Gemotoriseerde werktafel
- Gesloten koelvloeistofsysteem met koelpomp en spanenfilter volgens de machine richtlijn.
- Grote uitlading 375 mm
- Machine volledig gemonteerd

Geschikt voor:

- betere werkplaats, montagebedrijven, onderhoudsdienst, scholen en opleidingcentra, algemene industrie

Kenmerken:

- Elektromagnetische voeding, door een eenvoudige druk op één van de knoppen in de handgreep wordt de automatische voeding in- en uitgeschakeld.
- 6 voedingen aanwezig (St.37) : 0,05 / 0,1 / 0,15 / 0,20 / 0,25 / 0,30mm/omw.
- Stille kwalitatieve elektromotoren.
- Grote uitlading van 375 mm, waardoor grotere stukken kunnen worden bewerkt.
- Spil met precisie kogellagering.
- Hoge rondloopnauwkeurigheid door geharde en geslepen hoofdspindel.
- Tandwieloverbrenging wordt gesmeerd in een oliebad. Alle tandwielen en assen zijn geslepen en gehard.
- Zware, precies bewerkte werktafel met T-gleuven in diagonaalpatroon en 360° draaibaar rond de kolom, voorzien van dubbele klemming. D.m.v. van een brede tandlat wordt de tafel eenvoudig in de hoogte versteld.
- Eenvoudigere gereedschapswissel door automatische booruitdrijver
- Massieve, grote bodemplaat met T-gleuven.
- Ingewerkte halogeen machineverlichting 12V
- Tapfunctie (rechtsdraaiend tot op een bepaalde vooraf ingestelde diepte om vervolgens automatisch linksdraaiend terug te keren).
- Keuzeschakelaar twee snelheden
- Links- en rechtsdraaiend
- B50GSM ook verkrijgbaar in andere voltages: 3x220V/50Hz en 3x440V/60Hz. Opmerking: 3x220V = krachtstroom (drijfkracht). Dit is niet hetzelfde als 1x230V mono = wisselstroom

Veiligheden:

- Gebruiksvriendelijke bedieningsknoppen met aparte start- en stopdrukknop en aparte noodstop
- Nullastspanning
- Vergenelbare hoofdschakelaar
- Degelijke boorafscherming met microscharakelaar, boormachine valt onmiddellijk stil bij het openen van de afscherming

Order nr.	713034508	
Orig. nr.		B50GSM
Spanning	V	3x400
Vermogen motor	kW	3,0-2,4
Boorcap. in staal S235JR	mm	50
Boorcapaciteit bij continu gebruik S235JR	mm	45
Draadsnijcapaciteit in staal S235JR	M	42
Spilopname	MK	4
Uitlading	mm	375
Aantal snelheden		18
Spindeltoerental	min-1	54-2090
Diameter kolom	mm	200
Afstand spindel-tafel	mm	800
Afmetingen tafel (b x d)	mm	600x600
T-gleuven	mm	18
Maximum belastbaar gewicht	kg	300
Afstand spindel-voet	mm	1300
Afmetingen voet (b x d)	mm	600x520
T-gleuven voet	mm	18
Gewicht	kg	950,00
Afmetingen (l x b x h)	mm	1134 x 600 x 2460
Prijs	€	8.610,00

ACCESSOIRES

p. 1078-1151

MK4



950KO

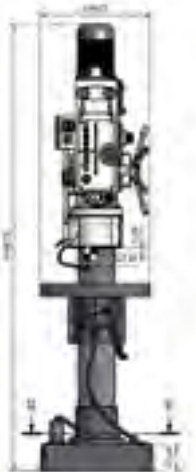
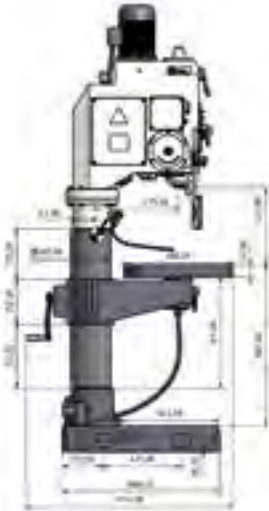

- 18 spilsnelheden
- Fijne boorvoeding
- Boorafscherming met microscharrelaar
- Zware gietijzeren tafel
- Geïntegreerde koelpomp
- Krachtige tweesnelheidsmotor 2,4/3,0 kW
- 6 voedingen
- Elektromagnetische voeding
- Verlichting
- Kolomdiameter Ø 200 mm
- Gemotoriseerde werktafel
- Spanenfilter volgens machinerichtlijn

Standaard geleverd met:

- Optimum snelspan boorkop 1-16 mm B16
- Kegeldoorn volgens DIN228 MK4 B16
- 2 T-moeren voor T-gleuf 18mm en draad M16.
- Nederlandstalige handleiding, opschriften, CE - kenmerk, en CE-attest volgens Machine richtlijn 2006/42/CE, Laagspanningsrichtlijn 2006/95/CE en EMC Richtlijn 2004/108/CE

Opgepast: machine niet afgevuld met tandwielolie, vergeet deze niet bij te bestellen, Helios 5, 790030020 (2 bussen)

Radiaalboormachines riem-/snaaraangedreven



Radiaal tafel- en kolomboormachine met grote uitlading voor hout, kunststof en aluminium.

Troeven:

- Radiaal uitvoering met grote uitlading
- Opname morse konus 2
- 5 spilsnelheden
- Motor 750 Watt met aluminium behuizing
- Prijsgunstig

Geschikt voor:

- Veeleisende doe-het-zelver
- Het bewerken van hout, kunststof en aluminium

Kenmerken:

- Gegarandeerde rondlooppauwkeurigheid beter dan 0,03 mm gemeten in de boorspindel
- Stille kwalitatieve elektromotoren
- Spil met precisie kogellagering
- Rustigere loop door aluminium riemschijven
- Door de getande kwaliteitsaandrijfriemen verkrijgt de machine een aanzienlijk betere krachtoverbrenging en beduidend minder prestatieverlies
- Boordiepte aanslag
- Precies bewerkte werktafel met T-gleuven in diagonaalpatroon, van -45° tot +45° zwenkbaar en 360° draaibaar rond de kolom. D.m.v. van een brede tandlat wordt de tafel eenvoudig in de hoogte versteld
- Massieve, grote bodemplaat met T-gleuven
- Lange, ergonomische stervormige handgreep uit 3 stukken met "soft grip"

Veiligheden:

- Gebruiksvriendelijke bedieningsknoppen met aparte start- en stopdrukknop en aparte noodstop
- Nullastspanning
- Degelijke boorafscherming **dubbel venster**, uitgerust met veiligheidsschakelaar
- V-snaarkap uitgerust met veiligheidsschakelaar

Order nr.		713009161	713009181
Orig. nr.		RB6T	RB8S
Spanning	V	1x230	1x230
Vermogen motor	kW	0,750	0,750
Boorcap. in staal S235JR	mm	16	16
Spilopname	MK	2	2
Aantal snelheden		5	5
Spindeltoerental	min-1	390-3000	390-3000
Boordiepte	mm	80	80
Uitlading	mm	115-430	115-430
Diameter kolom	mm	60	70
Afmetingen tafel (b x d)	mm	225x230	262x262
T-gleuven	mm	14	14
Zwenkbaarheid boortafel	°	+/- 45	+/- 45
Draaibaarheid boortafel	°	360	360
Afstand spindel-tafel	mm	380	740
Afstand spindel-voet	mm	550	1250
T-gleuven voet	mm	14	14
Gewicht	kg	40,00	63,00
Afmetingen (l x b x h)	mm	820 x 290 x 930	820 x 290 x 1640
Prijs	€	403,00	472,00

RBT6 - RB8S

MK2



RB8S

• Grote uitlading
115 - 430 mm



RBT6

Standaard geleverd met:

- Tandkrans boorkop 1-16 mm B16
- Kegeldoorn volgens DIN228 MK2/B16
- Nederlandstalige handleiding, opschriften, CE - kenmerk, en CE-attest volgens Machine richtlijn 2006/42/CE, Laagspanningsrichtlijn 2006/95/CE en EMC Richtlijn 2004/108/CE

Pneumatische taparmen

TAPPOTTEN

p. 1099

TOOLS

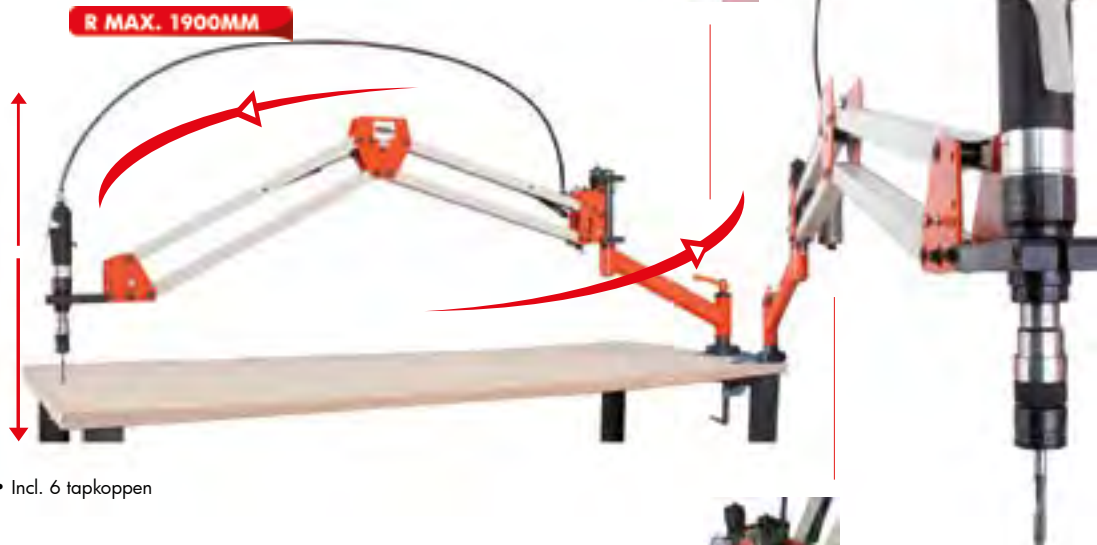

- Incl. 6 tapkoppen

Pneumatische taparm met grote actieradius en 6 tappotten.

Troeven:

- Met grote actieradius tot 1.900 mm !
- Snelheid, nauwkeurig en betrouwbaar
- Voorkom breken van uw tapen
- Perslucht aangedreven (compressor nodig)

Geschikt voor:

- Het gebruik in garages, werkplaatsen, opleidingcentra, scholen en verspaningtoepassingen

Geleverd met:

- Degelijke industriële tapspindel
- Beweegbare taparm met gasveren
- Voet
- Luchtdrukregelbaar met manometer
- 6 tappotten met slipkoppeling
- Vanaf PTA16 inclusief adapter

VOORKOM
TAPBREUK



Tip: Voor iedere tapmaat is er tappot met slipkoppeling nodig. De slipkoppeling is zodanig ingesteld dat het max. toelaatbare draaimoment nooit overschreden kan worden, hierdoor wordt het breken van de tap in bijvoorbeeld dure werkstukken voorkomen.

Aanbevolen compressor: 712007411 - Airstar 401/100 of zwaarder.

Order nr.		790004449 ^M	790004450 ^M	790004451 ^M	790004454 ^M
Orig. nr.		PTA12	PTA16	PTA20	PTA27
Voor tappen		M3-M12	M3-M16	M3-M20	M3-M27
Snelheid	tpm	400	300	150/400	70/220
Effectieve actieradius over 360° (1)	Rmax mm	1900	1900	1900	1900
Aanbevolen maximum druk	bar	6	6	6	6
Tapkoppen		M3/4/5/6/8 DIN371 M12 DIN352	M4/5/8/10 DIN371 M12/16 DIN352 + adapter	M8/10 DIN371 M12/16/18/20 DIN352 + adapter	M12/16/18/20/24/27 DIN352 + adapter
Effectieve actieradius over 360° (2)	Rmin mm	200	200	200	200
Luchtverbruik	l/min	+/- 800	+/- 950	+/- 950	+/- 950
Gewicht	kg	20,00	25,00	36,00	38,00
Prijs	€	1.459,00	1.985,00	2.909,00	2.995,00

KIES UW FREESKLEM



FMS



FMSN



HMS



DAS



MV3



ZAS50



MVC

	Ordernr.	BF16/VARIO	BF20U/VARIO	MB4	MB 4P	MH25V/MH25SV	MT50L	ME2/VARIO	ME4/VARIO	MT100	MT200	MT8	MZ4/MX4
Mechanische klem													
FMS100	713354100	●	●	●	●	●	●	●	●	●	●	●	●
FMS125	713354125			●	●	●	●	●	●	●	●	●	●
FMS150	713354150					●	●		●		●	●	●
FMS200	713354200										●	●	●
Mechanische precisie klem													
FMSN100	713354110		●	●	●	●	●	●	●	●	●	●	●
FMSN125	713354120			●	●	●	●	●	●	●	●	●	●
FMSN150	713354130								●		●	●	●
Hydraulische klem													
HMS100	713355100			●	●	●	●	●	●	●	●	●	●
HMS125	713355127			●	●	●	●	●	●	●	●	●	●
HMS150	713355150						●		●		●	●	●
HMS200	713355200										●	●	●
3-assige klem													
DAS100	713355500	●	●	●	●	●	●	●	●	●	●	●	●
3-assige klem													
MV3-75	713354175	●	●	●	●	●	●	●		●			●
MV3-125	713354178			●	●	●	●	●		●			●
2-assige klem													
ZAS50	713354170	●	●	●	●	●	●	●		●			●
Zelfcentrerende klem													
MVC160	713354214				●	●	●	●	●		●	●	●

● aanbevelen

Boor-freesmachines



Stabiele boorfreesmachine met elektronische toerental regeling met digitale weergave.

Troeven:

- Opname MK2 met draadopname M10
- Met traploos regelbare aandrijving 2 traps
- Krachtige motor van 850 Watt
- Boorfreeskop is onder hoek verstelbaar
- Digitale LED weergave van de spilsnelheden
- Digitale weergave van de diepte instelling
- Geïntegreerde halogeenverlichting 12 V, 10 W
- BF20L / BF20LD - **langsverplaatsing 480 mm**
- BF20LD met **digitale positieaanduiding DRO5** op 3 assen gemonteerd
- Machine volledig gemonteerd

Kenmerken:

- Boorfreesmachine met 2-traps tandwieloverbrenging, hoog en laag
- Precieze omlooptrouwkeurigheid door kogellagers beter dan 0,015 mm in de spil gemeten
- Stabiele en precieze zwaluwstaartuitvoering met regelbare spie-geleiders op de 3 assen
- Massieve en precies geslepen kruistafel met T-gleuven en koelmiddelrand
- Langsverplaatsing voorzien van mechanisch instelbare eindeloop schakelaars
- Gelijkstroom motor met permanente toerentalbewaking
- Boorfreeskop is langs beide zijden onder hoek instelbaar +/- 90°, maakt de meeste frees- en boorbewerkingen onder iedere hoek mogelijk
- Boorfreeskop is in de hoogte verstelbaar
- Kolom is langs beide zijden 30 mm verplaatsbaar, daardoor ook met onder hoek geplaatste boorfreeskop een langere verplaatsing en centrische bewerking van het werkstuk op de kruistafel mogelijk
- Gegoten stervormige handgreep voorzien van Soft grip handvatten
- Vaszetten van alle rijwegen mogelijk en alle verplaatsingen zijn met een schaal aanduiding uitgerust

Veiligheden:

- Eenvoudige bediening vooraan met aparte start/stop drukknop en aparte noodstop
- Boorafscherming voorzien van een microscharnelaar, bij het openen valt de machine stil
- Nullastspanning
- Hoofdscharnelaar

Order nr.		713338120	713338122	713338125
Orig. nr.		BF20 VARIO	BF20L VARIO	BF20LD VARIO
Spanning	V	1x230	1x230	1x230
Vermogen motor	kW	0,85	0,85	0,85
Boorcap. in staal S235JR	mm	16	16	16
Boorcapaciteit bij continu gebruik S235JR	mm	12	12	12
Maximum freescapaciteit vlakfrees	mm	63	63	63
Maximum freescapaciteit vingerfrees	mm	20	20	20
Spilopname	MK	2/M10	2/M10	2/M10
Uitlading	mm	185	185	185
Boordiepte	mm	50	50	50
Kop zwenkbaar	°	+/-90	+/-90	+/- 90
Aantal snelheden		2	2	2
Spindeltoeren langzaam	min-1	90-1480	90-1480	90-1480
Spindeltoeren snel	min-1	150-3000	150-3000	150-3000
Rijweg X-as	mm	280	480	480
Rijweg Y-as	mm	175	175	175
Rijweg Z-as	mm	370	370	370
Afmetingen tafel (b x d)	mm	500x180	700x180	700x180
Afmetingen T-groeven/afstand	mm	12/63	12/63	12/63
Gewicht	kg	106,00	120,00	120,00
Afmetingen (l x b x h)	mm	745 x 565 x 935	950 x 565 x 935	950 x 565 x 935
Prijs	€	1.379,00	1.495,00	2.395,00

BF20 VARIO

MK2/M10

ACCESSOIRES

p. 1076-1151

- Digitale LED weergave spijnsnelheden

- Links / rechts 90° schuinstelbare boorfreeskop

0,85KW VARIO 115KG

- Variabele toerentalregeling 90-3000 tpm

- Tandwieloverbrenging (hoog/laag)
- Digitale weergave diepteinstelling

- Precisie kruistafel met mechanisch instelbare eindelopen

- Boorafscherm met microschakelaar
- Zwaluwstaartgeleiding

- 3 handwielen met mm verdeling

- Balgafscherm

- Nastelbaar dmv spieën

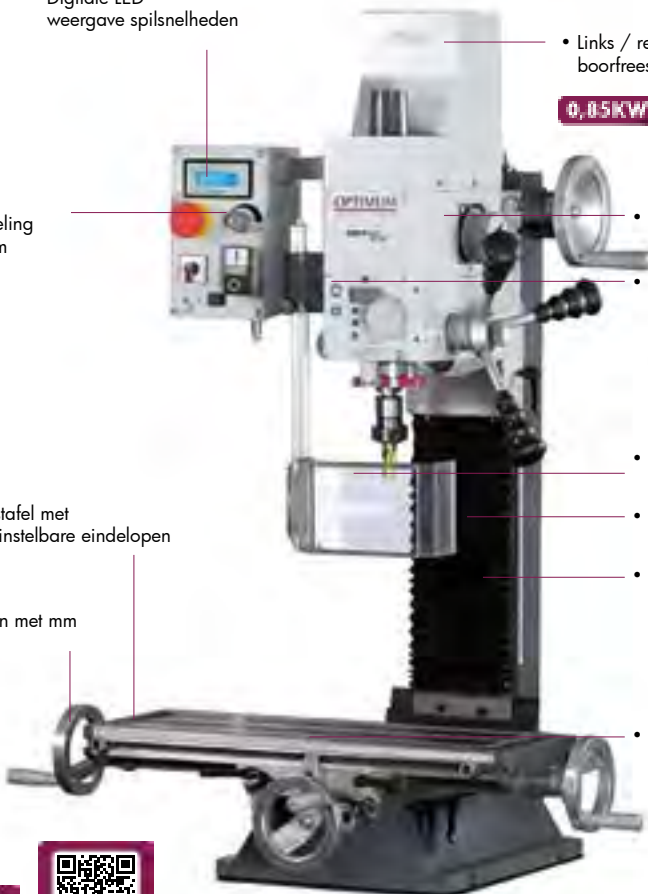

BF20L VARIO

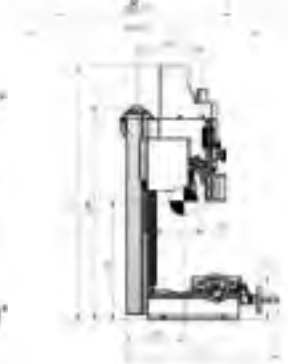

MACHINES

VERPL. 
X: 480MM
Y: 175 MM
Z: 370MM



- Universele machinevoet.
- Voor boormachine DX16V en boorfreesmachines BF16, BF20 en BF20L
 - Met twee inlegplanken
 - Optionele spanenopvangplaat nodig voor boorfreesmachines 713352999



BF20LD VARIO

Order nr.	713353000 	713352999 
Orig. nr.	FS1N	FS1P
Gewicht	kg 27,00	2,00
Afmetingen (l x b x h)	mm 340 x 420 x 800	720 x 470 x 30
Prijs	€ 170,00	33,50

Standaard geleverd met:

- Aantrekstang M10
- Bedieningsleutels
- Nederlandstalige handleiding, opschriften, CE-kenmerk, en CE-attest volgens Machine richtlijn 2006/42/CE, Laagspanningsrichtlijn 2006/95/CE en EMC Richtlijn 2004/108/CE



Stabiele boorfreesmachine met traploos regelbare aandrijving, en digitale snelheidsweergave.

Troeven:

- Spilopname MAS403 BT30
- Traploos regelbare toerental met potentiometer
- Digitale weergave van de spilsnelheden LED
- Eenvoudige gereedschapswissel d.m.v. tuimelaar
- Boorfreeskop onder hoek verstelbaar +/-45°
- Met gebruiksvriendelijk bedieningspaneel
- Tegengewicht voorkomt dat de Z-as zich van positie verplaatst
- Machine volledig gemonteerd

Kenmerken:

- Uiterst stabiele freeskop
- Precisie afgewerkt
- Alle geleidingen zijn geslepen en handgeschaapt (olieopvang voor smering)
- De assen zijn uitgerust met hoekcontactlagers, spelingsvrij nastelbaar
- Recht / linkslopend
- Massieve en precieze zwaluwstaartuitvoering met regelbare spie-geleiders op de 3 assen
- Stille krachtige elektromotor van 1.500 Watt. Gelijkstroom motor met permanente toerentalbewaking
- Massieve en precies geslepen kruistafel met T-gleuven en koelmiddelrand
- Metalen zalwstaartbescherming voor de Z-as
- Gebruiksvriendelijk bedieningspaneel, met drukcontacten met de vinger is voldoende om de touch functie te activeren
- Met aparte overzichtelijke elektrische kast

Veiligheden:

- Gebruiksvriendelijke bedieningsknopen met aparte start- en stopdrukknop en aparte noodstop
- Nullastspanning
- Degelijke booraafscherming **dubbel venster**, uitgerust met veiligheidsschakelaar
- Vergrendelbare hoofdschakelaar

Order nr.	713338155	
Orig. nr.		MH25V
Spanning	V	1x230
Freescapaciteit vlakfrees St.37	mm	50
Freescapaciteit vingerfrees St.37	mm	25
Boorcap. in staal S235JR	mm	25
Boorcapaciteit bij continu gebruik S235JR	mm	20
Spindeltoerental	min-1	200-4000
Uitlading	mm	185
Verplaatsing X-as	mm	400
Verplaatsing Y-as	mm	210
Verplaatsing Z-as	mm	270
Totaal verbruik	kW	2
Aandrijfmotor	kW	1.5
Torsieaandrijfmotor	Nm	10
Spilopname		BT30
Afstand spil-tafel	mm	305
Tafel lengte x breedte	mm	620x180
T-gleuven grootte/aantal/afstand		12 / 3 / 50
Maximum belastbaar gewicht	kg	30
Gewicht	kg	192,00
Afmetingen (l x b x h)	mm	914 x 844 x 1119
Prijs	€	2.995,00

MH25V

NEW BT30 VARIO

• Digitale LED weergave spijnsnelheden

• Dubbele afscherming met microscharakelaar

- Gereedschapswissel d.m.v. tuimelaar
- Onder hoek verstelbaar +/- 45°
- Potentiometer voor variabele toerentalregeling
- Metalen balbescherming
- Hoofdscharakelaar
- Sterk geribd
- Zwaluwstaartgeleiding



MH25V

VERPL
 X: 400MM (MAN.)
 Y: 210MM (MAN.)
 Z: 270MM (MAN.)

OPTIMUM



Machinevoet met opbergruimte voor MH25S / MH25SV.

Order nr.	713353009	
Orig. nr.	FS4	
Gewicht	kg	60,00
Afmetingen (l x b x h)	mm	625 x 415 x 750
Prijs	€	319,00

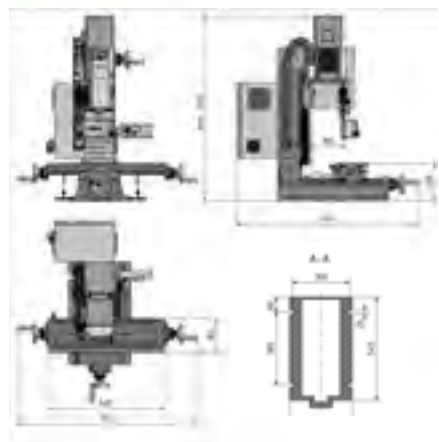

MACHINES

Standaard geleverd met:

- Bedieningsleutels
- Nederlandstalige handleiding, opschriften, CE - kenmerk, en CE-attest volgens Machine richtlijn 2006/42/CE, Laagspanningsrichtlijn 2006/95/CE en EMC Richtlijn 2004/108/CE.



Stabiele freesmachine met traploos regelbare aandrijving, met servomotoren en digitale positieaanduiding DRO5.

Troeven:

- Spilopname MAS403 BT30
- Traploos regelbare toerental met potentiometer
- **Met servomotoren**, automatische verplaatsingen door manueel op druktoesten te drukken
- Traploos instelbare voedingen op alle assen
- Digitale weergave van de spijnsnelheden LED
- **Digitale positieaanduiding DRO5 op 3 assen**
- Machine volledig gemonteerd

Kenmerken:

- Uiterst stabiele freeskop
- Precisie afgewerkt
- Alle geleidingen zijn geslepen en handgeschaapt (olieopvang voor smering)
- Boorfreeskop onder hoek verstelbaar +/-45°
- Tegengewicht voorkomt dat de Z-as zich van positie verplaatst
- De assen zijn uitgerust met hoekcontactlagers, spelingsvrij nastelbaar
- Recht / linkslopend
- Eenvoudige gereedschapswissel d.m.v. tuimelaar
- Voedingsspindels afstelbaar d.m.v. nastelbare spindelmoeren
- Ijlgang X / Y as voor vlugge positionering
- Bekabeling wordt mooi begeleid door een kabelgoot
- Eindschakelaars op de 3 assen
- Uitneembaar bedieningspaneel met:
 - Overzichtelijk geplaatste bedieningen gemakkelijk en snel te bedienen
 - Met drukcontacten met de vinger is voldoende om de touch functie te activeren
- Massieve en precieze zwaluwstaartuitvoering met regelbare spie-geleiders op de 3 assen
- Stille krachtige elektromotor van 1.500 Watt. Gelijksstroom motor met permanente toerentalbewaking.
- Massieve en precies geslepen kruisafel met T-gleuven en koelmiddelrand
- Metalen zaluwstaartbescherming voor de Z-as
- Met aparte overzichtelijke elektrische kast

Veiligheden:

- Gebruiksvriendelijke bedieningsknoppen met aparte start- en stopdrukknop en aparte noodstop
- Nullastspanning.
- Degelijke booraafscherming **dubbel venster**, uitgerust met veiligheidsschakelaar
- Vergrendelbare hoofdschakelaar

Order nr.	713338160	
Orig. nr.		MH25SV
Spanning	V	230
Freescapaciteit vlakfrees St.37	mm	50
Freescapaciteit vingfrees St.37	mm	25
Boorcap. in staal S235JR	mm	25
Boorcapaciteit bij continu gebruik S235JR	mm	20
Uitlading		185
Aantal snelheden	min-1	200-4000
Verplaatsing X-as	mm	400
Verplaatsing Y-as	mm	210
Verplaatsing Z-as	mm	270
Totaal verbruik	kW	2
Aandrijfmotor	kW	1.5
Torsieaandrijfmotor	Nm	10
Spilneus		BT30
X-as servomotor koppel	Nm	2.2
Y-as servomotor koppel	Nm	2.2
Z-as servomotor koppel	Nm	4.2
Voeding X, Y en Z-as	mm/min	
Ijlgang X, Y, Z-as	mm/min	930/580/450
Afstand spil-tafel	mm	300
Tafel lengte x breedte	mm	620x180
T-gleuven grootte/aantal/afstand		12 / 3 / 50
Maximum belastbaar gewicht	kg	30
Gewicht	kg	200,00
Afmetingen (l x b x h)	mm	914 x 844 x 1119
Prijs	€	4.195,00

MH25SV

NEW BT30 VARIO DRO SERVO



- Uitneembaar bedieningsbord
Touchfuncties



- Bekabeling in kabelgoot

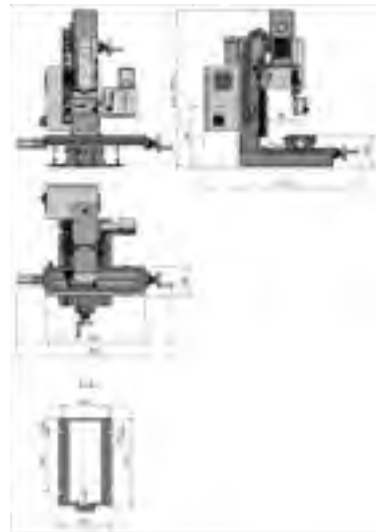

MACHINES

Standaard geleverd met:

- Bedieningsleutels
- Nederlandstalige handleiding, opschriften, CE - kenmerk, en CE-attest volgens Machine richtlijn 2006/42/CE, Laagspanningsrichtlijn 2006/95/CE en EMC Richtlijn 2004/108/CE.



Universele boorfreesmachine met tandwieloverbrenging en 12 spilsnelheden.

Troeven:

- Opname MK4 met draadopname M16
- Tandwieloverbrenging in een oliebad
- Krachtige tweesnelheid motor 1,1 / 1,5 kW
- Boorfreeskop onder hoek verstelbaar links / rechts
- Machine volledig gemonteerd

Geschikt voor:

- Werkplaatsen, onderhoudsdiensten, scholen en opleidingcentra

Kenmerken:

- Breed gamma toerentalbereik 95 – 3.200 tpm
- Boorfreeskop is langs beide zijden onder hoek instelbaar +/- 60°, maakt de meeste frees- en boorbewerkingen onder iedere hoek mogelijk
- Boorfreeskop is in de hoogte verstelbaar
- Hoge rondlooptrouwkeurigheid door geslepen spindel
- Snelheden worden vooraan gekozen
- Handwiel voor fijne manuele voeding
- Boodiepte aanslag
- Blokkeren van de spil mogelijk met degelijke spanhendel
- Keuzeschakelaar links - rechtsdraaiend
- Gegoten stervormige handgreep
- Vastzetten van alle rijwegen mogelijk en alle verplaatsingen zijn met een schaal aanduiding uitgerust
- Stabiele en precieze zwaluwstaartuitvoering met regelbare spie-geleiders op de 3 assen
- Massieve en precies geslepen kruistafel met T-gleuven en koelmiddelrand
- Langsverplaatsing voorzien van mechanisch instelbare eindeloop schakelaars

Veiligheden:

- Gebruiksvriendelijke bedieningsknopen met aparte start- en stopdrukknop en aparte noodstop
- Nullastspanning
- Degelijke boorafscherming, uitgerust met veiligheidsschakelaar

Order nr.	713338450 	
Orig. nr.		MB4
Spanning	V	3x400
Vermogen motor	kW	1,1/1,5
Boorcap. in staal S235JR	mm	32
Boorcapaciteit bij continu gebruik S235JR	mm	28
Maximum freescapaciteit vlakfrees	mm	63
Maximum freescapaciteit vingerfrees	mm	28
Spilopname	MK	4/M16
Uitlading	mm	275
Boordiepte	mm	120
Kop zwenkbaar	°	+/-60
Aantal snelheden		2x6
Spindeltoerental	min-1	95-3.200
Rijweg X-as	mm	450
Rijweg Y-as	mm	200
Rijweg Z-as	mm	430
Afmetingen tafel (b x d)	mm	800x240
Afmetingen T-groeven/afstand	mm	14/63
Gewicht	kg	320,00
Afmetingen (l x b x h)	mm	760 x 850 x 1150
Prijs	€	2.345,00

MK4/M16

1,1KW/1,5KW

ACCESSOIRES

p. 1076-1151

- Bedieningspaneel
- Links/rechts schakelaar
- Aparte noodstop
- Tweesnelheidsmotor 1,1/1,5kW
- Keuzeschakelaars voor snelheidswisseling
- Fijne manuele voeding
- Stalen handgrepen
- Z verplaatsing dmv hendel
- Zwaluwstaartgeleiding
- Precise kruistafel met afstelbare v-spieën

VERPL. 
 X: 450MM
 Y: 200MM
 Z: 430MM



MB4 met optionele voet

Machinevoet met opbergruimte en spanenopvangplaat voor MB4.

Order nr.	713353006 	
Orig. nr.	FS3	
Gewicht	kg	54,00
Afmetingen (l x b x h)	mm	625 x 415 x 750
Prijs	€	310,00

Standaard geleverd met:

- Aantrekstang M16
- Bedieningsleutels
- Nederlandstalige handleiding, opschriften, CE - kenmerk, en CE-attest volgens Machine richtlijn 2006/42/CE, Laagspanningsrichtlijn 2006/95/CE en EMC Richtlijn 2004/108/CE

Opgepast: Sokkel niet inbegrepen, machine niet afgewuld met tandwielolie, vergeet deze niet bij te bestellen, Helios 5, 790030020



Universele boorfreesmachine met boorvoeding, digitale aflezing, onderstel en automatische langsvoeding. MB4PV met traploos regelbare toerentalregeling.

Troeven:

- Opname MK4 met draadopname M16
- Tandwieloverbrenging in een oliebad
- Digitale aflezing op 3 assen
- Automatische mechanische boorvoedingen
- Gesloten koelvloeistofsysteem met koelpomp
- Automatische elektronische langsvoeding
- Onderstel

Geschikt voor:

- Werkplaatsen, onderhoudsdiensten, scholen en opleidingcentra

Kenmerken:

- MB4P: Krachtige tweesnelheid motor 1,1 / 1,5 kW - 3 x 400 V
- MB4PV: stille krachtige elektromotor 1,5 kW - 1 x 230 V
- MB4PV met traploos regelbare toerentalregeling
- Boorfreeskop is langs beide zijden onder hoek instelbaar +/- 60°, maakt de meeste frees- en boorbewerkingen onder iedere hoek mogelijk
- Gemotoriseerde Z hoogterverplaatsing van de boorfreeskop
- Hoge rondloopnauwkeurigheid door geslepen spindel
- Geïntegreerde bediening met aparte start/stop drukknop en aparte noodstop, links-rechtsdraaiend, koeling aan-uit, tapfunctie en digitale aflezing op 3 assen. MB4PV met weergave spilsnelheden
- Boorvoeding d.m.v. inschakelen handgreep
- Robuuste gietijzeren onderstel
- Vastzetten van alle rijwegen mogelijk en alle verplaatsingen zijn met een schaal aanduiding uitgerust
- Stabiele en precieze zwaluwstaartuitvoering met regelbare spie-geleiders op de 3 assen
- Massieve en precies geslepen kruistafel met T-gleuven en koelmiddelrand
- Langsverplaatsing voorzien van mechanische instelbare eindeloopt schakelaars

Veiligheden:

- Gebruiksvriendelijke bedieningsknoppen met aparte start- en stopdrukknop en aparte noodstop
- Nullastspanning
- Degelijke boorafscherming, uitgerust met veiligheidsschakelaar
- Vergrendelbare hoofdschakelaar

Order nr.		713338460	713338465
Orig. nr.		MB4P	MB4PV
Spanning	V	3x400	1x230
Vermogen motor	kW	1,1/1,5	1,5
Boorcap. in staal S235JR	mm	32	24
Boorcapaciteit bij continu gebruik S235JR	mm	28	20
Maximum freescapaciteit vlakfrees	mm	63	63
Maximum freescapaciteit vingerfrees	mm	28	25
Spilopname	MK	4/M16	4 / M16
Uitlading	mm	280	280
Boordiepte	mm	120	120
Kop zwenkbaar	°	+/-60	+/- 60
Aantal snelheden		2x6	2
Spindeltoerental	min-1	95-3200	60 - 2760
Rijweg X-as automatisch	mm	560	560
Rijweg Y-as	mm	230	195
Rijweg Z-as	mm	350	350
Afmetingen tafel (b x d)	mm	800x240	800 x 240
Afmetingen T-groeven/afstand	mm	14/80/3	14/80/3
Gewicht	kg	515,00	515,00
Afmetingen (l x b x h)	mm	1000 x 1300 x 2220	1000 x 1300 x 2220
Prijs	€	4.995,00	6.710,00

1,1KW/1,5KW

MK4/M16

515KO

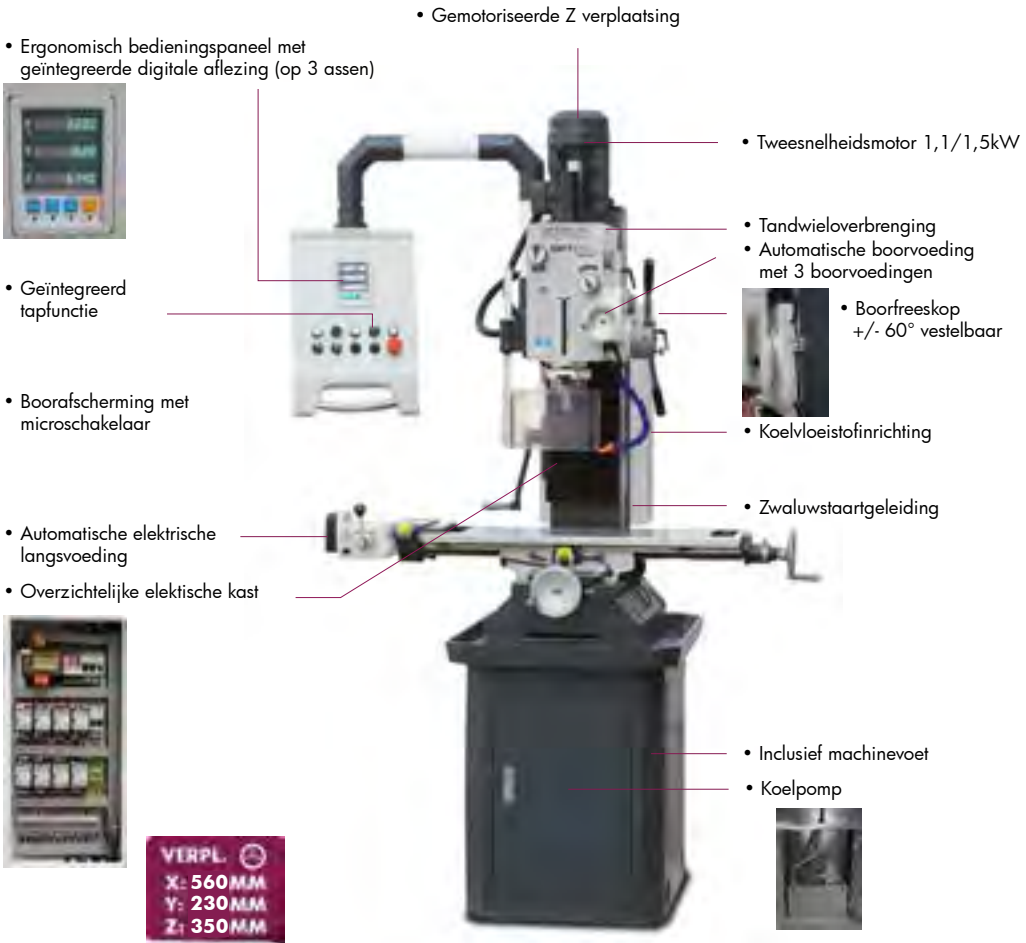

MB4P

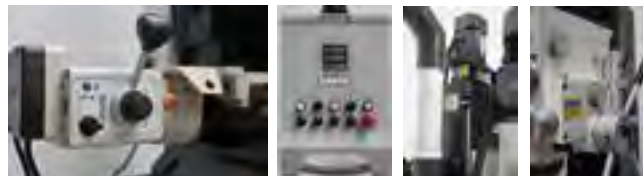

Standaard geleverd met:

- Aantrekstang M16
- Bedieningsleutels
- Nederlandstalige handleiding, opschriften, CE - kenmerk, en CE-attest volgens Machine richtlijn 2006/42/CE, Laagspanningsrichtlijn 2006/95/CE en EMC Richtlijn 2004/108/CE

Opgepast: machine niet afgevuld met tandwielolie, vergeet deze niet bij te bestellen, Helios 5, 790030020

Freemachines



Stabiele torenfreesmachines met frequentiesturing LENZE "Made in EU" voor de professionele gebruiker en algemene industrie.

Troeven:

- "Lenze" variabele toerentalregeling met inverter en potentiometer
- Breed gamma spijnsnelheden van 9 tot 6.750 tpm
- Digitale aflezing DPA2000 op 3 assen met glaslinialen
- Elektronische automatische langsvoeding
- Elektronische automatische dwarsvoeding
- Gemotoriseerde Z verplaatsing
- Pneumatische gereedschapsaantrekker
- Automatische mechanische boorvoedingen

Geschikt voor:

- professionele gebruiker en algemene industrie, onderhoudswerkplaatsen, matrijzenmakers, sholen, opleidingcentra
- diverse soorten materialen van roest vrij staal tot aluminium

Kenmerken:

- Hoge rondloop nauwkeurigheid door precisie kogellagers beter dan 0,01 mm
- Zware, massieve uitvoering uit hoogwaardig Meehanite gietijzer
- Alle assen (X, Y en Z) zijn precisie geslepen
- Stabiele blokgeleiding op de Y-as
- Grote verplaatsing van 400 mm in de Y as.
- Centrale smering van de geleidingen
- Stabiele kruistafel met geslepen T-gleuven en voorzien van een koelrand.
- Met boordiepte aanslag, afleesbaar langs de voorzijde en met mm schaalverdeling
- Spil is eveneens voorzien van een rem
- Freeskop is links/rechts onder hoek verstelbaar en is ook naar voren en naar achteren kantelbaar
- Massieve freesram kan eveneens naar voren en naar achteren zich verplaatsen
- Degelijke rubberen afscherming voor de zwaluwstaartgeleidingen
- Ergonomisch, zwenkbaar en gebruiksvriendelijk bedieningspaneel op pendelarm
- Keuzeschakelaar links - rechtsdraaiend
- Gesloten koelvloestofstelsysteem met koelpomp
- Degelijke spanen opvangbak

Order nr. 713336048

Algemeen

Orig. nr. MF4 VARIO DPA

Elektrische aansluiting

Spanning	V	3x400
Vermogen verticale spindel	kW	3,75
Freeskop zwenkbaar	°	45
Boorvoeding	mm/omw	0,04/0,08/0,15
Spilverplaatsing	mm	127
Aantal verticale spiltoeren		8 vario
Uitlading verticaal	mm	200-680

Capaciteit

Boorcap. in staal S235JR	mm	32
Boorcapaciteit bij continu gebruik S235JR	mm	28
Freescapaciteit vingerfrees maximum	mm	20
Freescapaciteit vlakfrees maximum	mm	100

Spil

Spilopname	ISO	40 DIN2080
Freeskop draaibaar	°	90
Verticale spindeltoeren	min-1	9-6.750

Verplaatsingen

Rijweg Z-as manueel	mm	406
Rijweg X-as automatisch	mm	800
Rijweg Y-as automatisch	mm	400
Horizontale tafel l x b	mm	1370x254
Maximum belastbaar gewicht	kg	275
T-gleuven grootte/afstand/aantal	mm	16 / 63
Afstand verticale spindel-kruistafel	mm	40-446
Gewicht	kg	1250,00
Afmetingen (l x b x h)	mm	1600 x 1800 x 2200

MF4DPA VARIO

ACCESSOIRES

p. 1076-1151

3,75KW

ISO 40

VARIO

1150KG

- Pneumatische gereedschapsaantrekker
- Spilrem
- 3 automatische boorvoedingen
- ISO 40 spildiameter 94mm
- Koeling
- Automatische elektronische dwarsvoeding Y
- Gemotoriseerde verticale verplaatsing Z
- Snelheidsomvormer **LENZE®**
- Draaiknop variabele spilsnelheden
- Digitale uitlezing op 3 assen
- Automatische elektronische langsvoeding X
- Spanenopvangbak



VERPL. 
X: 800MM (AUTO)
Y: 400MM (AUTO)
Z: 406MM (MAN.)

MF4DPA Vario

MACHINES

Veiligheden:

- Gebruiksvriendelijke bedieningsknoppen met aparte start- en stopdrukknop en aparte noodstop
- Nullastspanning
- Degelijke booratscherming, uitgerust met veiligheidsschakelaar, bij het openen valt de machine stil
- Veiligheidshandwielen op alle verplaatsingen
- Vergenelbare hoofdschakelaar

Standaard geleverd met :

- Aantrekstang M16
- Bedieningsleutels
- Nederlandstalige handleiding, opschriften, CE - kenmerk, en CE-attest volgens Machine richtlijn 2006/42/CE, Laagspanningsrichtlijn 2006/95/CE en EMC Richtlijn 2004/108/CE

Tip: Installatie, ingebruikname en scholing door gekwalificeerde technici op aanvraag



Torenfreesmachine met horizontale en verticale spindel met digitale uitlezing gemonteerd op 3 assen, met langsverplaatsing 770 mm.

Troeven:

- Verticale als horizontale freesspil opname ISO40
- Tandwieloverbrenging (verticale freesspil)
- Automatische mechanische langvoeding
- Digitale aflezing op 3 assen
- Langsverplaatsing van 770 mm
- Gesloten koelvloestofsysteem

Geschikt voor:

- Werkplaatsen, montagebedrijven, onderhoudsdiensten, scholen, opleidingcentra

Kenmerken:

- Zware, massieve uitvoering (900 kg)
- Krachtige motoren op de horizontale en verticale spindels
- Freeskop is langs beide zijden onder hoek instelbaar +/- 90°, maakt de meeste freesbewerkingen onder iedere hoek mogelijk
- Bediening en digitale uitlezing verwerkt in één paneel op pendelarm, met aparte start/stop drukknop en aparte noodstop, met keuzeschakelaar links - rechtsdraaiend
- Stervormige handgreep met ijzeren handvatten
- Rijweg Y-as manueel 200 mm
- Vastzetten van alle rijwegen mogelijk en alle verplaatsingen zijn met een schaal aanduiding uitgerust
- Handwiel voor fijne manuele voeding
- Stabiele en precieze zwaluwstaartuitvoering met regelbare spiegeleiders op de 3 assen
- Massieve en precies geslepen kruistafel met T-gleuven en koelmiddelrand.
- Langsverplaatsing voorzien van mechanisch instelbare eindeloop schakelaars
- Machineverlichting LED

Order nr.

713336006

Algemeen

Orig. nr. MT50 L

Elektrische aansluiting

Spanning	V	3x400
Gezamenlijk vermogen	kW	4.5
Vermogen verticale spindel	kW	1,1 / 2,2
Vermogen horizontale spindel	kW	1.5
Vermogen voedingsmotor	kW	0,37
Vermogen koelpomp	W	40
Spilverplaatsing	mm	120
Aantal verticale spiltoeren		8
Uitlading verticaal	mm	240 - 650
Horizontale spilopname	ISO	40
Horizontale spindeltoeren	min-1	58 - 1355
Uitlading horizontaal	mm	0 - 185

Capaciteit

Boorcap. in staal S235JR	mm	30
Boorcapaciteit bij continu gebruik S235JR	mm	25
Freescapaciteit vingerfrees maximum	mm	30
Freescapaciteit vlakfrees maximum	mm	100

Spil

Spilopname	ISO	40
Freeskop draaibaar	°	90
Aantal horizontale spiltoeren		9
Verticale spindeltoeren	min-1	115-1750

Verplaatsingen

Rijweg X-as manueel	mm	770
Rijweg Y-as manueel	mm	200
Rijweg Z-as manueel	mm	340
Rijweg X-as automatisch	mm	770
Aantal voedingen		8
Tafelvoeding X as	mm/min	24 - 720
Horizontale tafel l x b	mm	1200 x 200
Maximum belastbaar gewicht	kg	160
T-gleuven grootte/afstand/aantal	mm	14 / 4
Gewicht	kg	1150,00
Afmetingen (l x b x h)	mm	1250 x 1150 x 2250

MT50L

ACCESSOIRES

p. 1076-1151

1,1KW/2,2KW

1150KG

ISO 40



• Pendelarm zowel voor links als rechtshandigen

• Ergonomisch bedieningsbor met digitale uitlezing op 3 assen

• Onder hoek verstelbare freeskop +/- 90°

• Verticale freesspindel 115 -1750 tpm
• Machineverlichting

• Horizontale freesspindel 58 -1355 tpm

• Automatische mechanische voedingen op X en Y- as

• Inklapbare handwielen

• Geïntegreerde koelpomp

• Spanen opvangbak

VERPL.
X: 770MM (AUTO)
Y: 200MM (MAN.)
Z: 340MM (MAN.)

MT50L

MACHINES

Veiligheden:

- Gebruiksvriendelijke bedieningsknopen met aparte start- en stopdrukknop en aparte noodstop
- Nullastspanning
- Degelijke boorafscherming, uitgerust met veiligheidsschakelaar, bij het openen valt de machine stil
- Verwijderbare tafelscherming (verplicht bij werking horizontale spil), voorpaneel openklapbaar
- Veiligheidshandwiel op de automatische langsverplaatsing
- Vergenelbare hoofdschakelaar

Standaard geleverd met:

- Aantrekstang M16
- Kegeldoorn ISO40 - B18
- Tandkransboorkop met sleutel B18 - 1-16 mm
- Reductiehuls ISO40 - MK3, reductiehuls ISO40 - MK2
- Set spantanghouder ISO40 met 8 OZ spantangen 4-5-6-8-10-12-14
- Freesdoorn ISO40 ø 27, freesdoorn ISO40 ø 32
- Bedieningsleutels
- Nederlandstalige handleiding, opschriften, CE - kenmerk, en CE-attest volgens Machine richtlijn 2006/42/CE, Laagspanningsrichtlijn 2006/95/CE en EMC Richtlijn 2004/108/CE

Tip: Installatie, ingebruikname en scholing door gekwalificeerde technici op aanvraag



Multifunctionele torenfreesmachine met gereedschapsaantrekker voor professioneel gebruik met digitale positieaanduiding op 3 assen.

Troeven:

- Krachtige verticale freesspindel ISO40, 5,5 kW
- Volwaardige horizontale freesspindel ISO50
- Automatische mechanische voedingen op X, Y en Z
- Digitale aflezing op de 3 assen
- Automatische mechanische boorvoeding
- Pneumatische gereedschapsaantrekker

Geschikt voor:

- Industrie, constructiebedrijven, opleidingcentra en scholen, algemeen onderhoud

Kenmerken:

- Zwaar, compact model uit hoogwaardige Meehaniet gietijzer
- Solide rechthoekige (blok) geleidingen op de Y en Z as
- Solide, precieze kruistafel, groot gedimensioneerd en precisie geslepen oppervlak
- Alle assen zijn instelbaar door middel van spieen
- Instelbare boordiepte via millimeter schaal, afleesbaar aan de voorzijde
- Hoge rondloop nauwkeurigheid door conische rollagers minder dan 0,01 mm gemeten in de spindel
- Rechts / linksdraaiend voor het draadsnijden
- Gesloten koelvloestofstelsysteem met koelpomp
- Siemens elektrisch systeem
- 20 schakelbare spilsnelheden door twee snelheidmotor in verbinding met 5 snarengamma's
- Verticale freeskop kan zowel links als rechts onder hoek geplaatst worden. Deze kan niet naar voor en achteren geplaatst worden om zo zijn stabiliteit te bewaren bij het frezen.
- Centrale smering van de geleidingen
- Optimum LED machineverlichting
- Degelijke spanen opvangbak
- Op aanvraag leverbaar in 3 x 220 V / 50 Hz en 3 x 440 V / 60 Hz

Order nr. **713336088**

Algemeen

Orig. nr.		MT8
Elektrische aansluiting		
Spanning	V	3x400
Gezamenlijk vermogen	kW	10
Vermogen verticale spindel	kW	5.5
Vermogen horizontale spindel	kW	4
Luchtdrukaansluiting	bar	min. 6
Boorvoeding	mm/omw	0,86/0,45/0,42
Spilverplaatsing	mm	140
Aantal verticale spiltoeren		20
Horizontale spilopname	ISO	50 DIN2080
Horizontale spindeltoeren	min-1	58-1.800
Capaciteit		
Boorcap. in staal S235JR	mm	30
Boorcapaciteit bij continu gebruik S235JR	mm	21
Freescapaciteit vingervrees maximum	mm	25
Freescapaciteit vlakvrees maximum	mm	80
Spil		
Freeskop draaibaar	°	+/- 45
Verticale spindeltoeren	min-1	60-4.660
Verplaatsingen		
Rijweg X-as automatisch	mm	980
Rijweg Y-as automatisch	mm	300
Rijweg Z-as automatisch	mm	450
Aantal voedingen		9
Tafelvoeding X as	mm/min	15-370
Tafelvoeding Y-as	mm/min	15-370
Horizontale tafel l x b	mm	1320x360
Maximum belastbaar gewicht	kg	350
T-gleuven grootte/afstand/aantal	mm	18/80/3
Gewicht	kg	2600,00
Afmetingen (l x b x h)	mm	1920 x 1850 x 2300

MT8

ACCESSOIRES

p. 1076-1151

ISO 40

ISO 50

5,5kW

2500KG



- Horizontale freespositie
- Voor horizontale freesbewerkingen met freesas
- Instelbare geleidingslagers

- Mechanische voedinge op X en Y as

- Krachtige verticale spilmotor 5.5 kW
- Pneumatische gereedschapsaanrekker

- Geïntegreerd bedieningspaneel incl. digitale aflezing op pendelarm zowel voor links als rechtshandigen

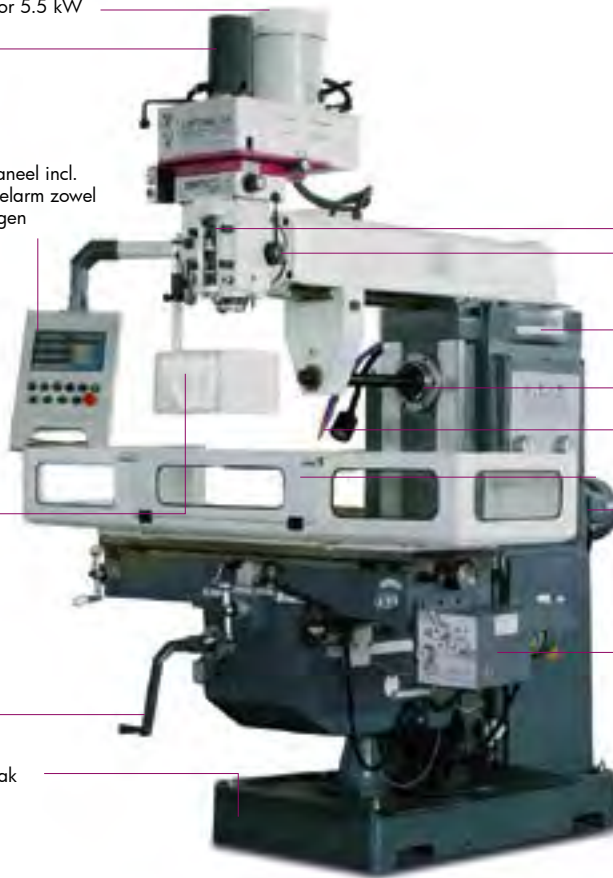

- Automatische boorvoeding
- Freeskop draaibaar +/-45°

- Verdraaibare RAM

- Horizontale spindel ISO50
- Gesloten koelvloeistofsysteem

- Degelijke freespil afscherming met microscharnelaar, alsook een tafel afscherming

- Krachtige stille motor 4kW

- Gemotoriseerde Z verplaatsing

- Mechanische automatische langs- en dwarsvoeding

- Degelijke spanenopvangbak



Veiligheden:

- Gebruiksvriendelijke bedieningsknopen met aparte start- en stopdrukknop en aparte noodstop
- Nullastspanning
- Degelijke boorafscherming, uitgerust met veiligheidsscharnelaar, bij het openen valt de machine stil
- Verwijderbare tafelaafscherming (verplicht bij werking horizontale spil), voorpaneel openklapbaar
- Veiligheidshandwielen op alle assen
- Vergenelbare hoofdscharnelaar

Standaard geleverd met:

- Snelspan boorkop 1-16 mm / B18
- Kegeldoorn ISO40 / B18
- Freesdoorn 7:24 ISO50
- Bedieningsleutels
- Nederlandstalige handleiding, opschriften, CE - kenmerk, en CE-attest volgens Machine richtlijn 2006/42/CE, Laagspanningsrichtlijn 2006/95/CE en EMC Richtlijn 2004/108/CE

Tip: Installatie, ingebruikname en scholing door gekwalificeerde technici op aanvraag.



Universele freesmachine met freeskop type Huron en digitale aflezing op 3 assen. Veelzijdig en eenvoudig om te bouwen voor het universele freeswerk in de werkplaats.

Troeven:

- Speciale freeskop type Huron over 2 draaiassen, 360°, opname ISO40
- Digitale aflezing op 3 assen
- Automatische mechanische langs- en dwarsvoeding
- Gemotoriseerde verticale Z verplaatsing
- Ophanging voor een horizontale freespositie met freesas(freeskop dient niet verwijderd te worden)

Geschikt voor:

- Betere werkplaatsen, montagebedrijven, onderhoudsdiensten, scholen, opleidingscentra

Kenmerken:

- Zware, massieve uitvoering uit hoogwaardig Meehanite gietijzer
- Alle zwaluwstaartgeleidingen zijn gehard en geslepen en voorzien van regelbare afstelspieën
- Centrale smering van de geleidingen
- Geïntegreerd Optimum bedieningspaneel, ergonomisch, zwenkbaar en gebruiksvriendelijk op pendelarm
- Keuzeschakelaar links - rechtsdraaiend
- Massieve kruistafel, precies geslepen bovenvlak, groot gedimensioneerd en voorzien van T-gleuven
- Groot gedimensioneerde handwielen met mm schaalverdeling
- Eenvoudige bediening van de snelheden op de ram door twee schakelhendels
- Gesloten koelvloeistofstelsysteem met koelpomp
- Optimum LED machineverlichting
- Degelijke spanen opvangbak
- Op aanvraag leverbaar in 3 x 220 V / 50 Hz en 3 x 440 V / 60 Hz

Order nr.	713336110	
Algemeen		
Orig. nr.		MT100
Elektrische aansluiting		
Spanning	V	3x400
Gezamenlijk vermogen	kW	3.6
Vermogen verticale spindel	kW	2.2
Vermogen voedingsmotor	kW	0.370
Vermogen tafelmotor	W	750
Vermogen koelpomp	W	40
Aantal verticale spiltoeren		11
Capaciteit		
Boorcap. in staal S235JR	mm	20
Boorcapaciteit bij continu gebruik S235JR	mm	18
Freescapaciteit vingerfrees maximum	mm	16
Freescapaciteit vlakfrees maximum	mm	85
Spil		
Spilopname	ISO	40 DIN2080
Aantrestang		M16
Freeskop draaibaar	°	360
Verticale spindeltoeren	min-1	40-1.600
Verplaatsingen		
Rijweg X-as manueel	mm	600
Rijweg Y-as manueel	mm	270
Rijweg X-as automatisch	mm	600
Rijweg Y-as automatisch	mm	270
Rijweg Z-as automatisch	mm	380
Aantal voedingen		9
Tafelvoeding X as	mm/min	24-402
Tafelvoeding Y-as	mm/min	24-402
Ijlgang X as	mm/min	402
Ijlgang Y as	mm/min	402
Ijlgang Z as	mm/min	402
Horizontale tafel l x b	mm	1120x260
Maximum belastbaar gewicht	kg	350
T-gleuven grootte/afstand/aantal	mm	14/63/3
Afstand verticale spindel-kruistafel	mm	90-520
Gewicht	kg	1360,00
Afmetingen (l x b x h)	mm	1620 x 1520 x 2220

MT100

ACCESSOIRES

p. 1076-1151

ISO 40

3,6KW

1360KG

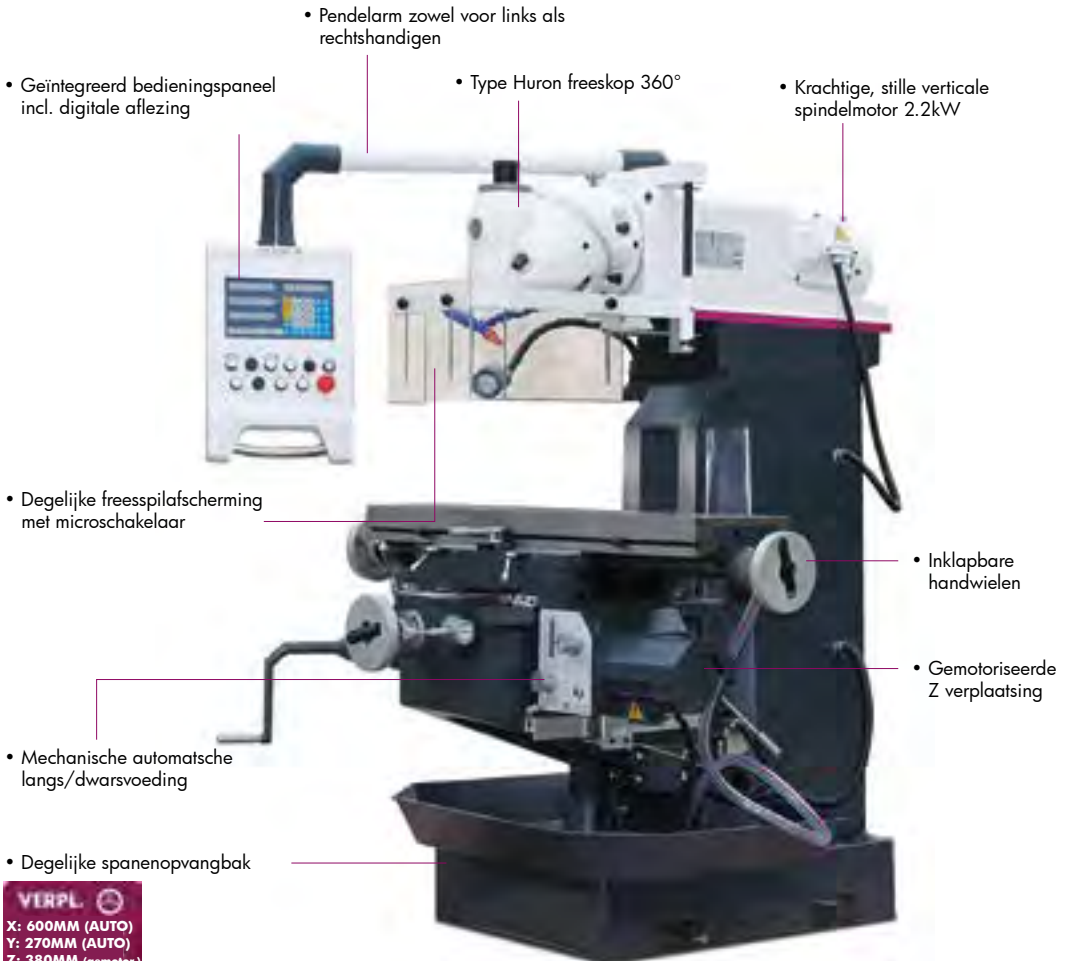

MACHINES

Veiligheden:

- Gebruiksvriendelijke bedieningsknoppen met aparte start- en stopdrukknop en aparte noodstop
- Nullastspanning.
- Degelijke boorafscherming, uitgerust met veiligheidsscharakelaar, bij het openen valt de machine stil.
- Verwijderbare tafelfafscherming (verplicht bij werking horizontale spil), voorpaneel openklapbaar
- Veiligheidshandwielen op alle assen
- Vergendelbare hoofdscharakelaar

Standaard geleverd met:

- Aantrekstang M16
- Freesas ISO40 ø 32 mm
- Spantangenhouder ISO40 met OZ spantangen
- Vlakfreeshouder ISO40 / ø 22 mm
- Bedieningsleutels
- Nederlandstalige handleiding, opschriften, CE - kenmerk, en CE-attest volgens Machine richtlijn 2006/42/CE, Laagspanningsrichtlijn 2006/95/CE en EMC Richtlijn 2004/108/CE

Tip: Installatie, ingebruikname en scholing door gekwalificeerde technici op aanvraag.

Universele freesmachine met freeskop type Huron, 3 automatische mechanische voedingen en digitale aflezing op 3 assen.

Troeven:

- Speciale freeskop type Huron over 2 draaiassen, 360°, opname ISO50
- Volwaardige horizontale freesspindel
- Automatische mechanische voedingen op X, Y en Z
- Krachtige spilmotoren
- Digitale aflezing op de 3 assen

Geschikt voor:

- Industrie, constructiebedrijven, opleidingcentra en scholen, algemeen onderhoud

Kenmerken:

- Zware, massieve uitvoering uit hoogwaardig Meehanite gietijzere
- De Y en Z blokgeleidingen, X zwaluwstaartgeleiding zijn gehard en geslepen en voorzien van regelbare afstelspieën
- Centrale smering van de geleidingen
- Massieve kruistafel, precies geslepen bovenvlak, groot gedimensioneerd en voorzien van T-gleuven
- Tafel is verdraaibaar onder 35°
- Groot gedimensioneerde handwielen met mm schaalverdeling
- Ophanging voor een horizontale freespositie met freesas
- Eenvoudige bediening van de snelheden op de ram door drie schakelhendels
- Links – rechtsloop
- Ergonomisch, zwenkbaar en gebruiksvriendelijk bedieningspaneel op pendelarm
- Gesloten koelvloeistofstelsysteem met koelpomp
- Optimum LED machineverlichting
- Degelijke spanen opvangbak
- Op aanvraag leverbaar in 3 x 220 V / 50 Hz (met transfo) en 3 x 440 V / 60 Hz

Order nr. **713336120**

Algemeen

Orig. nr. MT200

Elektrische aansluiting

Spanning	V	3x400
Gezamenlijk vermogen	kW	9,2
Vermogen verticale spindel	kW	4
Vermogen horizontale spindel	kW	4
Vermogen voedingsmotor	kW	1,1
Vermogen koelpomp	W	90
Tankinhoud	l	27
Freeskop zwenkbaar	°	360
Aantal verticale spiltoeren		12
Horizontale spilopname	ISO	50 DIN2080/M24
Horizontale spindeltoeren	min-1	58-1.800

Capaciteit

Boorcap. in staal S235JR	mm	30
Boorcapaciteit bij continu gebruik S235JR	mm	28
Freescapaciteit vingerfrees maximum	mm	20
Freescapaciteit vlakfrees maximum	mm	100

Spil

Spilopname	ISO	50 DIN2080/M24
Freeskop draaibaar	°	360
Aantal horizontale spiltoeren		12
Verticale spindeltoeren	min-1	60-1.750

Verplaatsingen

Rijweg X-as manueel	mm	1290
Rijweg Y-as manueel	mm	268
Rijweg X-as automatisch	mm	1.000
Rijweg Y-as automatisch	mm	280
Rijweg Z-as automatisch	mm	400
Aantal voedingen		9
Tafelvoeding X as	mm/min	22-420
Tafelvoeding Y-as	mm/min	22-393
Tafelvoeding Z-as	mm/min	10-168
Ijlgang X as	mm/min	1.290
Ijlgang Y as	mm/min	1205
Ijlgang Z as	mm/min	513
Kruistafel verstelbaar	°	35
Maximum belastbaar gewicht	kg	450
T-gleuven grootte/afstand/aantal	mm	14/63/3
Gewicht	kg	2750,00
Afmetingen (l x b x h)	mm	2070 x 2270 x 2250

MT200

ACCESSOIRES

p. 1076-1151

ISO 50

9,2KW

1300KG

• Verticale spilsnelheden 60-1750 tpm

• Type Huron 360°

• Ergonomisch bedieningsbord met digitale uitlezing op 3 assen

• Horizontale spilsnelheden 58-1800 tpm

• Centrale smering van de kruistafel

• Kruistafel

• Draaibaar 35°

• Mechanische automatische voedingen X, Y en Z

• Degelijke spanenopvangbak

• Standaard koelpomp

VERPL. 
X: 1290MM (AUTO)
Y: 280MM (AUTO)
Z: 400MM (AUTO)

Veiligheden:

- Gebruiksvriendelijke bedieningsknopen met aparte start- en stopdrukknop en aparte noodstop
- Nullastspanning.
- Degelijke boorafscherming, uitgerust met veiligheidsschakelaar, bij het openen valt de machine stil
- Verwijderbare tafelaafscherming (verplicht bij werking horizontale spil), voorpaneel openklapbaar
- Veiligheidshandwielen op alle assen
- Vergendelbare hoofdschakelaar

Standaard geleverd met:

- Aantrekstang M24
- Vlakfrees houder ISO50 ø 32 mm
- Spantangenhouder ISO50 met OZ spantangen
- Frees ISO50 / ø 22 mm en ø 27 mm
- Bedieningsleutels
- Nederlandstalige handleiding, opschriften, CE - kenmerk, en CE-attest volgens Machine richtlijn 2006/42/CE, Laagspanningsrichtlijn 2006/95/CE en EMC Richtlijn 2004/108/CE

Tip: Installatie, ingebruikname en scholing door gekwalificeerde technici op aanvraag.



Gereedschapsfreesmachine voor de professionele gebruiker met digitale positieaanduiding op 3 assen.

Troeven:

- Veelzijdige toepassingsmogelijkheden
- Opname ISO40
- Met automatische voedingen in X, Y en Z assen
- Spilkop onder hoek verstelbaar +/-90°
- Horizontale freespositie met ondersteuningsarm en freesas
- Digitale uitlezing DPA2000 op 3 assen

Geschikt voor:

- Industrie, gereedschapmaker; matrijzenmaker, opleidingcentra en scholen, algemeen onderhoud

Kenmerken:

- Precisie geslepen werktafels voor de horizontale en verticale positie met T-gleuven
- Gebruiksvriendelijke snelheidsverandering
- Robuuste machine constructie
- Verticale freeskop is wegklapbaar
- Zware, solide, geribde hoogwaardig grijs gietijzeren basis
- Alle geleidingen zijn gehard en instelbaar via spieën
- Centrale smering
- Groot gedimensioneerde handwielen met afleeschalen
- Uitgerust met een gesloten koelsysteem
- Spanen opvangbak
- LED machineverlichting Optimum
- Op aanvraag leverbaar in 3x220V/50Hz en 3x440V/60Hz

Order nr.	713346140 	
Algemeen		
Orig. nr.		MX4
Elektrische aansluiting		
Spanning	V	3x400
Vermogen verticale spindel	kW	3
Spilverplaatsing	mm	80
Aantal verticale spiltoeren		40
Uitlading verticaal	mm	540
Capaciteit		
Boorcap. in staal S235JR	mm	32
Boorcapaciteit bij continu gebruik S235JR	mm	28
Spil		
Spilopname	ISO	40 (DIN 2080)
Verticale spindeltoeren	min-1	40-2000
Verplaatsingen		
Rijweg X-as automatisch	mm	500
Rijweg Y-as automatisch	mm	400
Rijweg Z-as automatisch	mm	400
Aantal voedingen		18
Tafelvoeding X as	mm/min	10-380
Tafelvoeding Y-as	mm/min	10-380
Tafelvoeding Z-as	mm/min	10-380
Ijlgang X as	mm/min	1.200
Ijlgang Y as	mm/min	1.200
Horizontale tafel l x b	mm	800 x 400
Afstand horizontale spindel - kruistafel	mm	95 - 475
Verticale tafel l x b	mm	1.060 x 250
Afstand verticale spindel-kruistafel	mm	55 - 445
T-gleuven grootte/afstand/aantal	mm	
Maximum lengte (DPA arm links/rechts)	mm	1.880 / 1.340
Gewicht	kg	1250,00
Afmetingen (l x b x h)	mm	1340 x 2400 x 1950

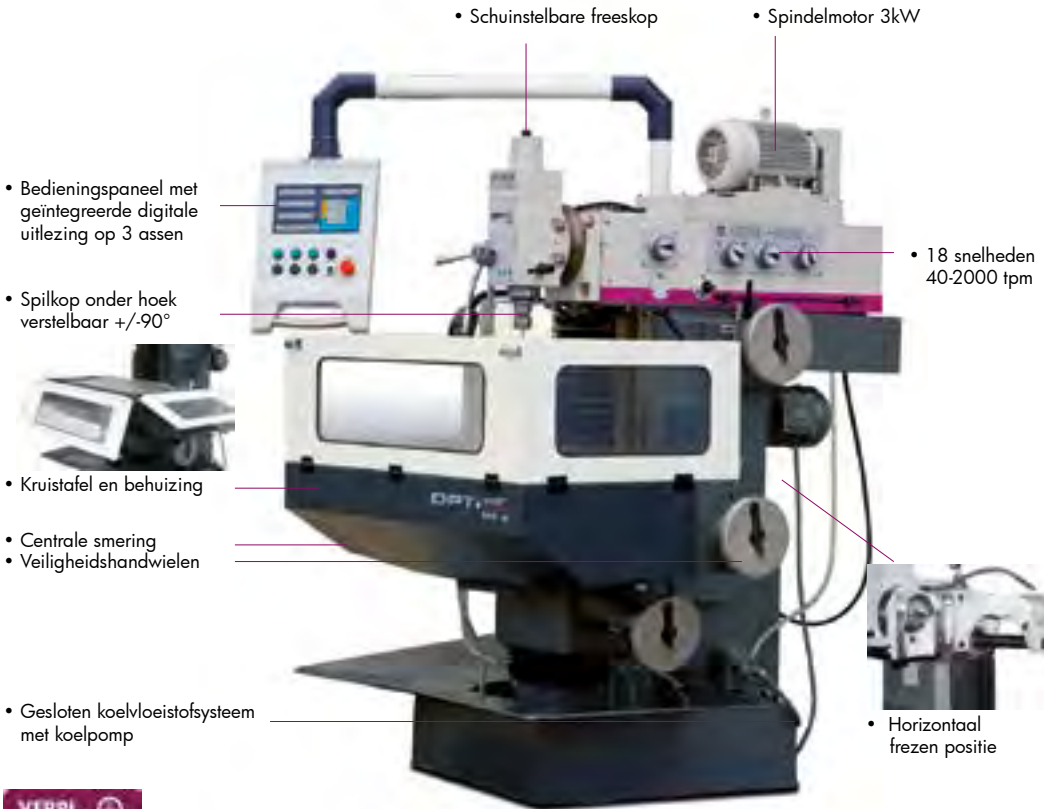

VERPL. 
X: 500MM (AUTO)
Y: 400MM (AUTO)
Z: 400MM (AUTO)

Veiligheden:

- Gebruiksvriendelijke bedieningsknopen met aparte start- en stopdrukknop en aparte noodstop
- Nullastspanning.
- Degelijke boorafscherming, uitgerust met veiligheidsschakelaar, bij het openen valt de machine stil.
- Openklapbare tafelaafscherming
- Veiligheidshandwielen op alle assen
- Vergenelbare hoofdschakelaar

Standaard geleverd met:

- Bedieningsgereedschap
- Ondersteuningsarm voor horizontale freespositie
- Reductiehuizen ISO40-MK1, ISO40-MK2, ISO40-MK3
- Nederlandstalige handleiding, opschriften, CE - kenmerk, en CE-attest volgens Machine richtlijn 2006/42/CE, Laagspanningsrichtlijn 2006/95/CE en EMC Richtlijn 2004/108/CE

Tip: Installatie, ingebruikname en scholing door gekwalificeerde technici op aanvraag



Kwaliteits en precisie gereedschapsfreesmachine voor de professionele gebruiker met digitale positieaanduiding Newall DP700 op 3 assen.

Troeven:

- Veelzijdige toepassingsmogelijkheden
- Opname ISO40
- Met automatische elektronische voedingen in X, Y en Z assen via inverter
- Kogelomloopspindels op de 3 assen
- Spilkop onder hoek verstelbaar +/-90°
- Horizontale freespositie met ondersteuningsarm en freesas
- Digitale uitlezing Newall DP700 op 3 assen

Geschikt voor:

- Industrie, gereedschapsmaker, matrijzenmaker, opleidingcentra en scholen, algemeen onderhoud

Kenmerken:

- Precisie geslepen werktafels voor de horizontale en verticale positie met T-gleuven
- Zwaluwstaartgeleidingen op X en Y as
- Blokgeleiding op de Z as
- Gebruiksvriendelijke snelheidsverandering
- Robuuste machine constructie
- Verticale freeskop is wegklapbaar
- Zware, solide, geribde hoogwaardig grijs gietijzeren basis
- Alle geleidingen zijn gehard en instelbaar via spieën
- Centrale smering
- Groot gedimensioneerde handwielen met afleeschalen
- Uitgerust met een gesloten koelsysteem
- Spanen opvangbak
- LED machineverlichting Optimum
- Aparte en overzichtelijke elektrische kast
- Op aanvraag leverbaar in 3x220V/50Hz en 3x440V/60Hz

Order nr.

713346240

Algemeen

Orig. nr.		MZ4
Elektrische aansluiting		
Spanning	V	3x400
Gezamenlijk vermogen	kW	6
Vermogen verticale spindel	kW	3
Vermogen horizontale spindel	kW	3
Vermogen voedingsmotor	kW	0,75
Vermogen tafelmotor	W	0
Vermogen koelpomp	W	90
Spilverplaatsing	mm	120
Aantal verticale spiltoeren		18
Capaciteit		
Boorcap. in staal S235JR	mm	20
Boorcapaciteit bij continu gebruik S235JR	mm	16
Freescapaciteit vingerfrees maximum	mm	25
Freescapaciteit vlakfrees maximum	mm	63
Spil		
Spilopname	ISO	40
Freeskop draaibaar	°	90
Verticale spindeltoeren	min-1	40-2250
Verplaatsingen		
Rijweg X-as manueel	mm	600
Rijweg Y-as manueel	mm	485
Rijweg Z-as manueel	mm	400
Rijweg X-as automatisch	mm	585
Rijweg Y-as automatisch	mm	465
Rijweg Z-as automatisch	mm	385
Horizontale tafel l x b	mm	900x500
Maximum belastbaar gewicht	kg	500
T-gleuven grootte/afstand/aantal	mm	14 / 63 / 7
Gewicht	kg	1450,00
Afmetingen (l x b x h)	mm	1850 x 1850 x 2150

NEW ISO 40 3KW

**Veiligheden:**

- Gebruiksvriendelijke bedieningsknopen met aparte start- en stopdrukknop en aparte noodstop
- Nullastspanning.
- Degelijke boorafscherming, uitgerust met veiligheidsschakelaar, bij het openen valt de machine stil.
- Openklapbare tafelaafscherming
- Veiligheidshandwielen op alle assen
- Vergenelbare hoofdschakelaar

Standaard geleverd met:

- Bedieningsgereedschap
- Ondersteuningsarm voor horizontale freespositie
- Reductiehuizen ISO40-MK3, MK3-MK2, MK3-MK1
- Spantanghouder met 7 OZ spantangen (ø6,8,10,12,16,20,25)
- Nederlandstalige handleiding, opschriften, CE - kenmerk, en CE-attest volgens Machine richtlijn 2006/42/CE, Laagspanningsrichtlijn 2006/95/CE en EMC Richtlijn 2004/108/CE

Tip: Installatie, ingebruikname en scholing door gekwalificeerde technici op aanvraag

KIES UW **OPTi**turn[®] DRAAIBANK

	Vermogen	Centerhoogte	Centerlengte	Draaidiameter	Spilboring
TU1503V	0,45	70	250	140	11
TU2004V	0,6	100	300	200	21
TU2304	0,75	115	450	230	20
TU2304V	0,75	115	450	230	20
TU2406	0,75	125	550	250	21
TU2406V	1,1	125	550	250	21
TU2506V	1,1	125	550	250	26
TU2807	0,85	140	700	266	26
TU2807V	1,5	140	700	266	26
TU3008	1,1	150	800	300	36
TU3008V	1,5	150	800	300	36
TH3309/TH3309D	1,5	156	910	350	38
TU3309V	2,2	145	910	350	38
TH3610/TH3610D	1,5	180	1000	356	52
TH4010/TH4010D	1,5/2,4	205	1000	410	52
TH4010V	4	205	1000	410	52
D420x1000/1500	4,5	210	1000/1500	420	52
TH4610/TH4615	5,5	230	1000/1500/2000	465	58
TH4615V	7,5	230	1500	465	80
TH5615/TH5620 TH5630	7,5	280	1500/2000/3000	560	80
TH5620V	7,5	280	2000	560	105
D660x2000/3000	7,5	330	2000/3000	660	105
TU8020/TU 8030	7,5	330	2000/3000	660	105

Spilsnelheden	Klauwplaat 3 bekken	Onafhankelijke 4 bekken plaat	Vario Drive	Digit. snelheidsweergave	DPA Versie	Verlichting	230V	400V
120-3000	●		●				●	
150-2500	●		●	●			●	
125-2000	●						●	
150-2200	●		●	●			●	●
125-2000	●						●	
150-2500	●						●	
150-2500	●		●	●			●	
150-2000	●						●	●
30-4000	●		●	●			●	
150-2000	●						●	
30-3000								
60-2000					●/-	●		●
12-2250			●	●	●	●	●	
70-2000					●/-	●		●
45-1800					●/-	●		●
30-3000			●	●	●	●		●
45-1800	●	●			●	●		●
25-2000					●	●		●
30-2000			●	●	●	●		●
25-1600					●	●		●
25-1600			●	●	●	●		●
25-1600	●	●			●	●		●
25-1600	●				●	●		●

Draaibanken



De nieuwe, compacte draaibank met elektronisch regelbare snelheden.

Capaciteiten:

- Centerhoogte: 75 mm
- Centerlengte: 300 mm
- Spilboring: 11 mm

Troeven:

- Elektronische traploze toerentalregeling vanaf 120 tot 3000 min-1
- Compact tafemodel
- Automatische langs draaien
- Rechts / linkslopend omschakelaar

Geschikt voor:

- Thuiswerker, doe-het-zelver

Kenmerken:

- Gelijkstroommotor met permanente toerentalbewaking 230V
- Geribd prismabed uit grijsgietijzer, inductie gehard en precisie geslepen
- Geharde en geslepen prismabedgeleidingen
- Gegarandeerde spilneus rondloop nauwkeurigheid beter dan 0,015 mm
- Rondloopnauwkeurigheid klauwplaat max. 0,05 mm
- Met leispil voor het draadsnijden of automatisch langs draaien
- Met langs, dwars, en kleine slede
- Handwielen met instelbare fijn regeling 0,04/0,01 mm
- Alle geleidingen zijn door middel van spieën spelingsvrij af te stellen

Veiligheden

- Aparte noodstop, aparte start en stopknop
- Nullastspanning
- Lage voltage bedieningsknopen
- Microschakelaars in tandwielkast en klauwplaatfcherming
- EMC filter, klasse B (gebruikt in huishoudapparatuur)

Order nr.	713420260	
Algemeen		
Orig. nr.	TU1503V	
Elektrische aansluiting		
Spanning	V	1x230
Vermogen motor	kW	0,45
Capaciteit		
Centerhoogte	mm	75
Centerafstand	mm	300
Draaidiameter boven bed	mm	140
Bedbreedte	mm	70
Kop		
Aantal snelheden		variabel
Spindeltoerental	min-1	120-3.000
Spilkonus	MK	1
Spilboring	mm	11
Draadstappen en voeding		
Langsvoeding	mm/O	0,05-0,1
Draadsnijden metrisch	M	0.5-1.5 (11)
Geleiding en wagen		
Rijweg beitel slede	mm	40
Rijweg dwarslede	mm	55
Hoogte beitelhouder	mm	12
Losse kop		
Konus losse kop	MK	1
Koers losse kop	mm	30
Gewicht	kg	22,00
Afmetingen (l x b x h)	mm	560 x 320 x 250
Prijs	€	865,00

TU1503V

ACCESSOIRES

p. 1076-1151

VARIO

250MM

11MM

70MM

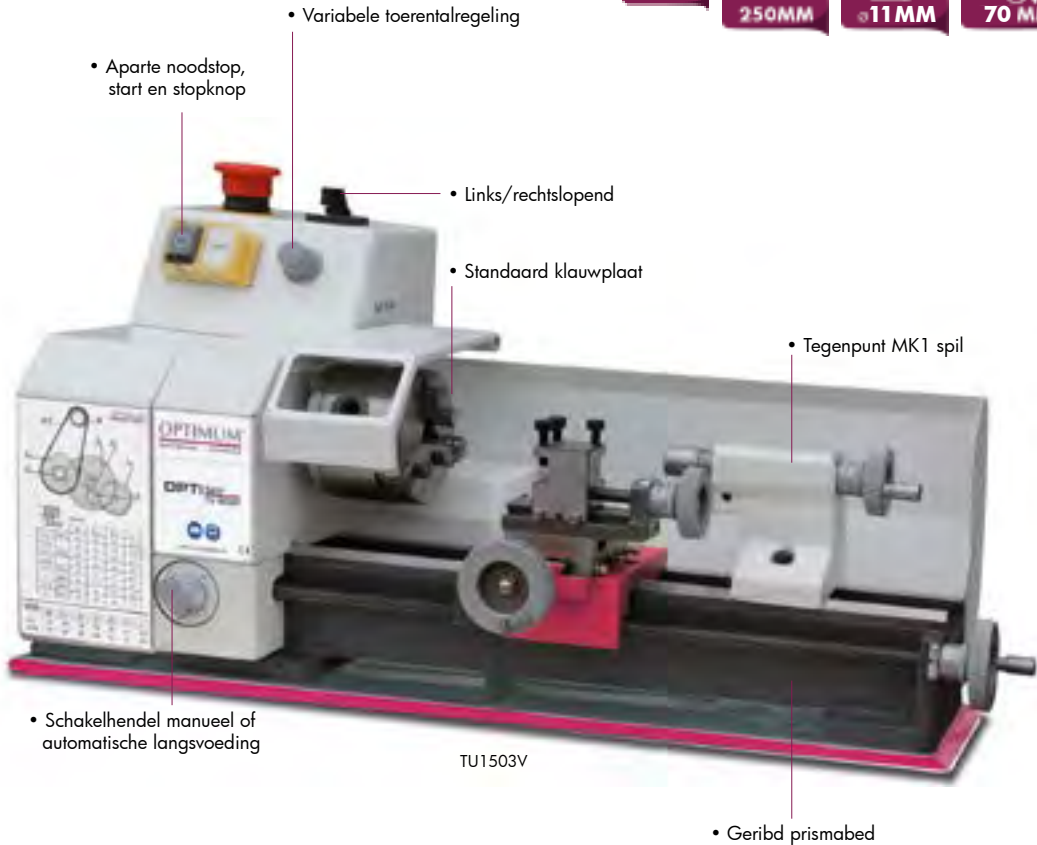
**Standaard geleverd met:**

- Klauwplaat met 3 klauwen 80 mm
- Vast centerpunt MK1
- Klauwplaatafscherming, spatwand en spanenbak
- 2-voudige beitelhouder
- Wisselwielenset.
- Nederlandstalige handleiding, opschriften, CE - kenmerk, en CE-attest

Draaibank met digitale toerentalweergave en variabele toerentalregeling.

Capaciteiten:

- Centerhoogte: 100 mm
- Centerlente: 300 mm
- Spilboring: 21 mm

Troeven:

- 2 traps variabele toerentalregeling van 150-250 min en 300-2500 min.
- Digitale weergave van de spilsnelheden
- Compact tafelmodel
- Automatische langs draaien
- Rechts / linkslopend omschakelaar

Geschikt voor:

- Vlakdraaien, langs draaien, en draad snijden.
- Scholen / opleidingscentra, RenD afdeling, modelbouwer, thuiswerker en doe-het-zelver

Kenmerken:

- Hoge en precieze afwerkinggraad
- Sterk geribd prismabed uit grijsgietijzer, inductie gehard en precisie geslepen
- Geharde en geslepen prismabed geleidingen
- Geharde spilneus (DIN6350) en gelagerd in na stelbare kegelkogellagers klasse P5 kwaliteit.
- Gegarandeerde rondloop nauwkeurigheid van de spilneus beter dan 0,009 mm
- Met leispil voor het draad snijden of automatisch langs draaien
- Met langs, dwars, en kleine slede
- Voorzien van druklagers en leispindel in twee sinterlagers
- Losse kop kan +/- 2,5 mm verschoven worden voor het draaien van kegels, met snelklemming van de losse kop voor een nog betere klemming
- Alle geleidingen door middel van spelijsen zonder speling na stelbaar
- Krachtige, onderhoudsvrije motor

Veiligheden

- Aparte noodstop, aparte start en stopknop
- Nullastspanning
- Lage voltage bedieningsknopen
- Microschakelaars in tandwielkast en klauwplaat afscherming
- Beitelafscherming
- EMC filter, klasse B (gebruikt in huishoudapparatuur)

Order nr. 713420310

Algemeen

Orig. nr. TU2004V 230V

Elektrische aansluiting

Spanning V 1x230
 Vermogen motor kW 0,6

Capaciteit

Centerhoogte mm 100
 Centerafstand mm 300
 Draaidiameter boven bed mm 110
 Bedbreedte mm 100

Kop

Aantal snelheden 2 traploos
 Spindeltoerental min-1 150-2.500
 Spilkonus MK 3
 Spilboring mm 21
 Doorlaat klauwplaat mm 20

Draadstappen en voeding

Langsvoeding mm/O 0.1-0.2
 Draadsnijden metrisch M 0,5-3 (11)
 Draadsnijden duim Gg/1" 44-10 (8)

Geleiding en wagen

Rijweg beitel slede mm 55
 Rijweg dwars slede mm 75
 Hoogte beitelhouder mm 12

Losse kop

Konus losse kop MK 2
 Koers losse kop mm 65
 Gewicht kg 61,00
 Afmetingen (l x b x h) mm 830 x 425 x 360

Prijs € 1.299,00

TU2004V

ACCESSOIRES

p. 1076-1151

VARIO

300MM

21MM

100MM

- Digitale weergave spilsnelheden

- Aparte noodstop

- Klauwplaatafscherming met microscharakelaar

- Tegenpunt MK2 spil

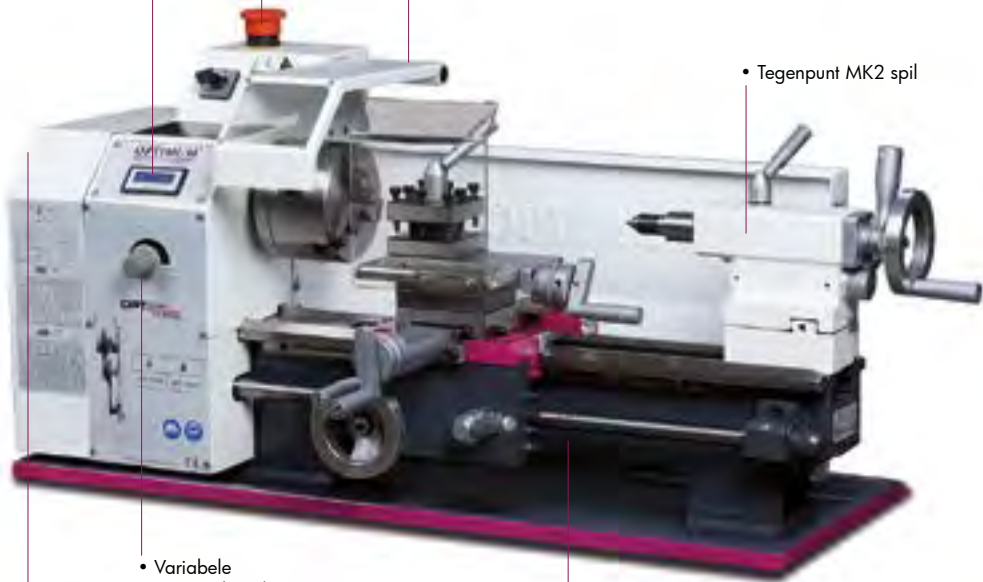

- Variabele toerentalregeling

TU2004V

- Rolgewalste leispindel

- Optionele voet



- Geharde & geslepen tandwielen



Standaard geleverd met:

- Klauwplaat met 3 klauwen 100 mm
- Vast centerpunt MK2
- Vast centerpunt MK3
- Klauwplaat- en beitel afscherming, spatwand en spanenbak
- 4-voudige beitelhouder
- Wisselwielen set.
- Bedieningssleutels
- Nederlandstalige handleiding, opschriften, CE - kenmerk, en CE-attest volgens Machine richtlijn 2006/42/CE, Laagspanningsrichtlijn 2006/95/CE en EMC Richtlijn 2004/108/CE

MACHINES

Draaibank voor de veeleisende doe-het-zelver. TU2304V met digitale toerentalweergave en variabele toerentalregeling.

Capaciteiten:

- Centerhoogte: 115 mm
- Centerlengte: 450 mm
- Spilboring: 21 mm

Troeven:

- TU2304: 6 snelheden 125 - 2000 min-1
- TU2304V: 2 - traps variabele toerentalregeling van 150 -2.200 min
- TU2304V digitale weergave spilsnelheden
- Automatische langs draaien
- Rechts / linkslopend omschakelaar

Geschikt voor:

- Vlakdraaien, langs draaien, en draad snijden
- Scholen / opleidingscentra, RenD afdeling, modelbouwer, thuiswerker en doe-het-zelver

Kenmerken:

- Hoge en precieze afwerkinggraad
- Sterk geribd prismabed uit grijsgietijzer, inductie gehard en precisie geslepen
- Geharde spilneus en gelagerd in na stelbare kegelkogellagers klasse P5 kwaliteit
- Gegarandeerde rondloop nauwkeurigheid van de spilneus beter dan 0,009 mm + rondloop nauwkeurigheid klauwplaat beter dan 0,05 mm
- Met leispil voor het draad snijden of automatisch langs draaien
- Met langs, dwars, en kleine slede
- Voorzien van druklager op de dwars (voor het opnemen van axiale krachten)
- Leispindel in twee sinterlagers (glijlagers met olie, die geen smering meer vereisen)
- Losse kop kan +- 5 mm verplaatst worden voor het draaien van kegels, met snelklemming van de losse kop voor een nog betere klemming
- Alle geleidingen door middel van speliijsten zonder speling na stelbaar
- Krachtige, onderhoudsvrije motor

Veiligheden:

- Aparte noodstop, aparte start en stopknop
- Nullastspanning
- Lage voltage bedieningsknopen
- Microschakelaars in tandwielkast en klauwplaat afscherming
- Beitelafscherming
- EMC filter, klasse B (bij TU2304V)

Order nr.	713420320	713420325
Algemeen		
Orig. nr.	TU2304 230V	TU2304V 230V
Elektrische aansluiting		
Spanning	V	1x230
Vermogen motor	kW	0,75
Capaciteit		
Centerhoogte	mm	115
Centerafstand	mm	450
Draaidiameter boven bed	mm	230
Bedbreedte	mm	135
Kop		
Aantal snelheden		6
Spindeltoerental	min-1	125-2.000
Spilkonus	MK	3
Spilboring	mm	21
Draadstappen en voeding		
Draadsnijden metrisch	M	0.4-3.5
Draadsnijden duim	Gg/1"	44-10
Geleiding en wagen		
Rijweg beitel slede	mm	75
Rijweg dwars slede	mm	120
Hoogte beitelhouder	mm	14x14
Losse kop		
Konus losse kop	MK	2
Koers losse kop	mm	70
Gewicht	kg	111,00
Afmetingen (l x b x h)	mm	965 x 585 x 510
Prijs	€	1.469,00
		1.729,00

TU2304/TU2304V

ACCESSOIRES

p. 1076-1151

VARIO

450 MM

21 MM

115 MM

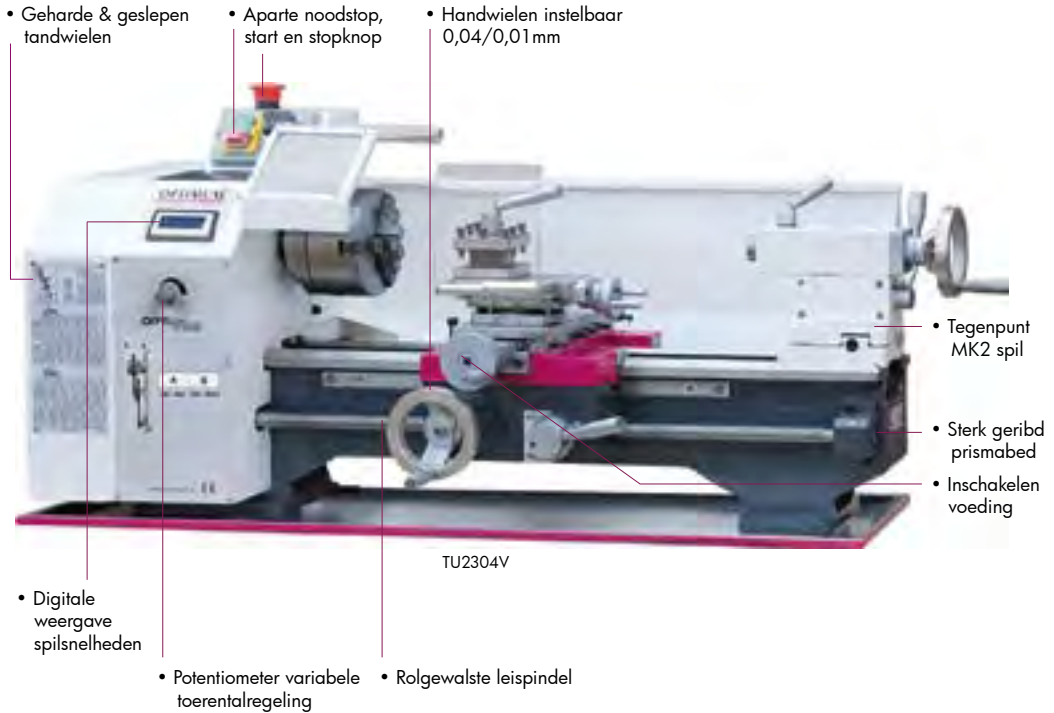
**Standaard geleverd met:**

- Klauwplaat met 3 klauwen 100 mm
- Vast centerpunt MK2
- Vast centerpunt MK3
- Klauwplaat- en beitel afscherming en spatwand
- 4-voudige beitelhouder
- Wisselwielen set
- Bedieningsleutels
- Nederlandstalige handleiding, opschriften, CE - kenmerk, en CE-attest volgens Machine richtlijn 2006/42/CE, Laagspanningsrichtlijn 2006/95/CE en EMC Richtlijn 2004/108/CE

Tip: wordt geleverd zonder onderstel, vergeet deze niet bij te bestellen 713440409.

Draaibanken voor de veeleisende doe-het-zelver. TU2406V met variabele toerentalregeling.

Capaciteiten:

- Centerhoogte: 125 mm
- Centerlengte: 550 mm
- Spilboring: 21 mm

Troeven:

- TU2406: 6 snelheden 125 - 2000 min-1
- TU2406V: 2 - traps variabele toerentalregeling van 150 -2.500 min-1.
- TU2406V digitale weergave spijlsnelheden
- Automatische langs draaien
- Rechts / linkslopend omschakelaar
- Kleinste model beschikbaar in 3x400V

Geschikt voor:

- Vlakdraaien, langs draaien, en draad snijden.
- Scholen / opleidingscentra, RenD afdeling, modelbouwer, thuiswerker en doe-het-zelver

Kenmerken:

- Hoge en precieze afwerkinggraad
- Sterk geribd prismabed uit grijsgietijzer, inductie gehard en precisie geslepen
- Geharde en geslepen prismabed geleidingen
- Gegarandeerde rondloop nauwkeurigheid van de spilneus beter dan 0,009 mm
- Rondlooppauwkeurigheid van de klauwplaat beter dan 0,05 mm
- Met langs, dwars, en kleine slede
- Rolgewalste trapeziumspindel
- Voorzien van druklager op de dwars (voor het opnemen van axiale krachten)
- Leispindel in twee sinterlagers (glijlagers met olie, die geen smering meer vereisen)
- Losse kop kan +- 5 mm verplaatst worden voor het draaien van kegels, met snelklemming van de losse kop voor een nog betere klemming
- Alle geleidingen door middel van spijlijsten zonder speling na stelbaar.
- Krachtige, onderhoudsvrije motor.

Veiligheden:

- Aparte noodstop, aparte start en stopknop
- Nullastspanning
- Lage voltage bedieningsknopen
- Microschakelaars in tandwielkast en klauwplaatafscherming
- Beitelafscherming
- EMC filter, klasse B (bij TU2406V)

Order nr.		713420350	713420353	713420355
Algemeen				
Orig. nr.		TU2406 230V	TU2406 400V	TU2406V 230V
Elektrische aansluiting				
Spanning	V	1x230	3x400	1x230
Vermogen motor	kW	0,750	0,750	1.1
Capaciteit				
Centerhoogte	mm	125	125	125
Centerafstand	mm	550	550	550
Draaidiameter boven bed	mm	250	250	250
Bedbreedte	mm	135	135	135
Kop				
Aantal snelheden		6	6	2 traploos
Spindeltoerental	min-1	125-2000	125-2000	150-2500
Spilkonus	MK	3	3	3
Spilboring	mm	21	21	21
Draadstappen en voeding				
Draadsnijden metrisch	M	0.4-3.5	0.4-3.5	0.4-3.5
Draadsnijden duim	Gg/1"	44-10	44-10	44-10
Geleiding en wagen				
Rijweg beitelplede	mm	75	75	75
Rijweg dwarsplede	mm	120	120	120
Hoogte beitelhouder	mm	14x14	14x14	14x14
Losse kop				
Konus losse kop	MK	2	2	2
Koers losse kop	mm	70	70	70
Gewicht	kg	125,00	125,00	125,00
Afmetingen (l x b x h)	mm	1310 x 420 x 560	1310 x 420 x 560	1310 x 520 x 560
Prijs	€	1.725,00	1.675,00	1.959,00

TU2406/TU2406V

ACCESSOIRES

p. 1076-1151

VARIO

450 MM

21 MM

115 MM

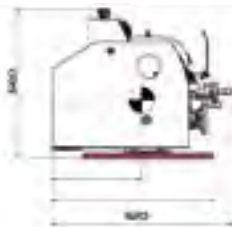
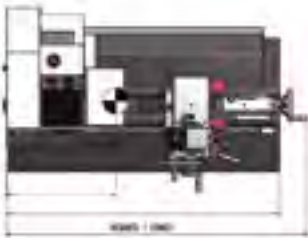

TU2406V

**Standaard geleverd met :**

- Klauwplaat met 3 klauwen 125 mm
- Vast centerpunt MK2
- Vast centerpunt MK3
- Klauwplaat- en beitel afscherming en spatwand
- 4-voudige beitelhouder
- Wisselwielen set.
- Bedieningsleutels
- Nederlandstalige handleiding, opschriften, CE - kenmerk, en CE-attest volgens Machine richtlijn 2006/42/CE, Laagspanningsrichtlijn 2006/95/CE en EMC Richtlijn 2004/108/CE.

Tip: wordt geleverd zonder onderstel, vergeet deze niet bij te bestellen 713440409.

Hoge precieze draaibank voor de veeleisende gebruiker. Vario uitvoering met frequentieomvormer.

Capaciteiten:

- Centerhoogte: 125 mm
- Centerlengte: 550 mm
- Spilboring: 26 mm

Troeven:

- TU2506: 6 snelheden 125 -2000 min-1
- TU2506V: 4 traps variabele toerentalregeling via frequentieomvormer van 30 - 4000 min
- TU2506V: digitale weergave van spilsnelheden
- Lichtlopende aanvoeraandrijving met afgeronde tandwielen, lopend in een oliebad
- Met een voedingsas voor draadsnijden of het automatisch langsdraaien
- Keuzeschakelaar rechts – linksdraaiend

Geschikt voor:

- Vlakdraaien, langs draaien, en draad snijden
- Scholen / opleidingscentra, RenD afdeling, modelbouwer, thuiswerker en doe-het-zelver

Kenmerken:

- Inductie geharde en precisie geslepen prismabed geleidingen
- Gegarandeerde rondloop nauwkeurigheid van de spilneus beter dan 0,009 mm
- Rondlooppnauwkeurigheid klauwplaat beter dan 0,05 mm
- Hoge en precieze afwerkingsgraad
- Rolgewalste trapezium leispindel wordt ondersteund door 2 gesinterde lagers.
- Handwielen op de wagen met schaalverdeling 0,04 / 0,01 mm
- Kegelrollagers in kwaliteit klasse P5
- Druklagers
- Sterk geribd prismabed van gietstaal, inductie gehard en fijn geslepen
- Losse kop kan +- 5 mm verschoven worden voor het draaien van kegels
- Krachtige, onderhoudsvrije motor

Veiligheden:

- Aparte noodstop, aparte start en stopknop
- Nullastspanning
- Lage voltage bedieningsknoppen
- Microschakelaars in tandwielkast en klauwplaatafscherming
- Beitelafscherming

Order nr.	713425001	713425003	713425006
Algemeen			
Orig. nr.	TU2506 230V	TU2506 400V	TU2506V
Elektrische aansluiting			
Spanning	V	1x230	3x400
Vermogen motor	kW	0,75	0,75
			1,5
Capaciteit			
Centerhoogte	mm	125	125
Centerafstand	mm	550	550
Draaidiameter boven bed	mm	250	250
Draailengte in de bedbrug	mm	135	135
Bedbreedte	mm	135	135
Kop			
Aantal snelheden		6	6
Spindeltoerental	min-1	125-2.000	125-2.000
Spilkonus	MK	4	4
Spilboring	mm	26	26
Draadstappen en voeding			
Langsvoeding	mm/O	0,07-0,2	0,07-0,2
Draadsnijden metrisch	M	0,2-3,5	0,2-3,5
Draadsnijden duim	Gg/1"	56-8	56-8
Geleiding en wagen			
Rijweg beitelglede	mm	70	70
Rijweg dwarsglede	mm	110	110
Hoogte beitelhouder	mm	13	13
Losse kop			
Konus losse kop	MK	2	2
Koers losse kop	mm	65	65
Gewicht	kg	125,00	125,00
Afmetingen (l x b x h)	mm	1250 x 585 x 475	1250 x 585 x 475
			1200 x 640 x 580
Prijs	€	1.839,00	1.839,00
			2.759,00

TU2506/TU2506V

ACCESSOIRES

p. 1076-1151

VARIO

550 MM

26MM

125 MM

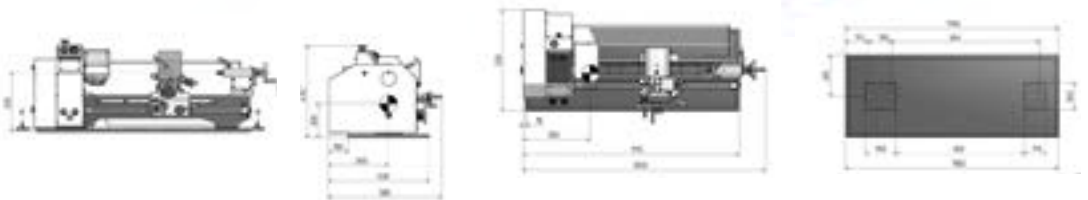
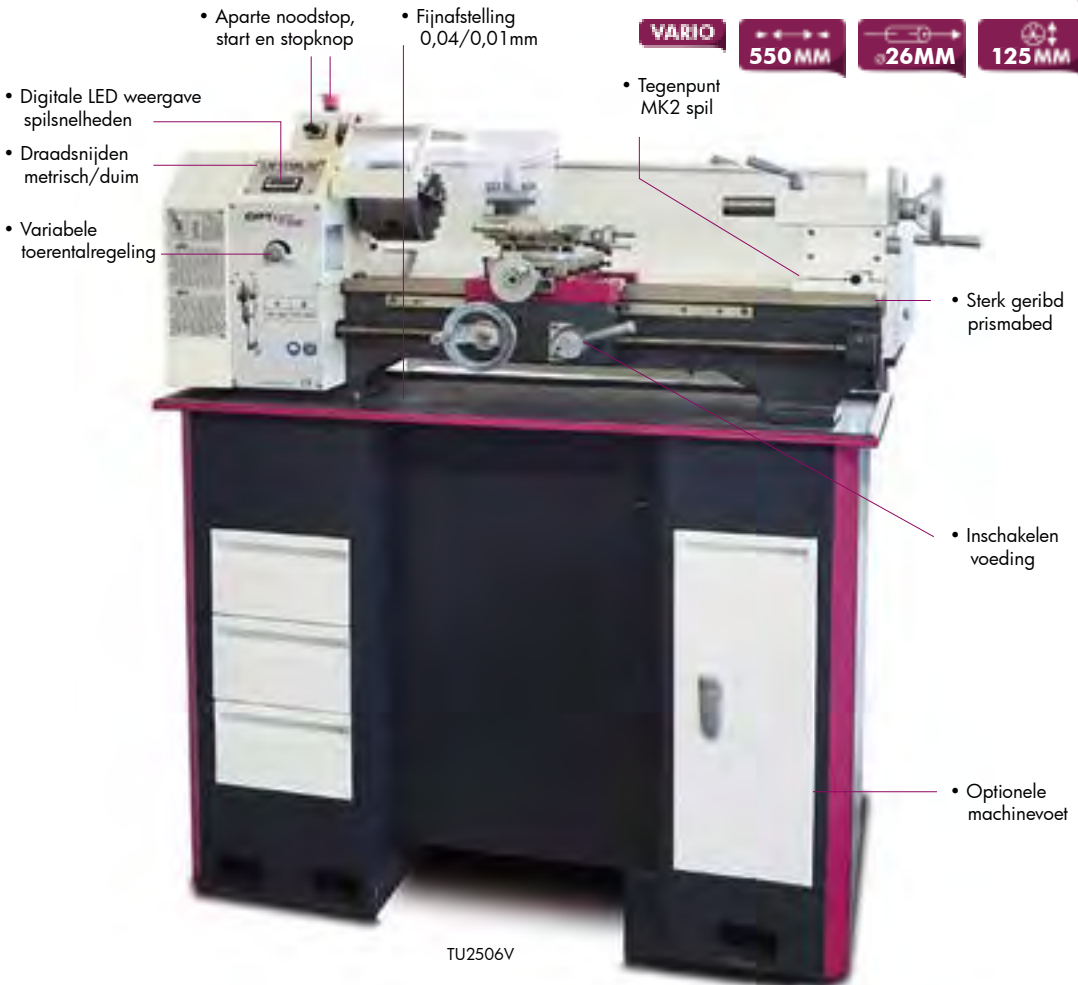

MACHINES

Standaard geleverd met:

- Klauwplaat met 3 klauwen 125 mm
- Vast centerpunt MK2
- Vast centerpunt MK4
- Meenemer
- Klauwplaat- en beitel afscherming, spatwand en spanenbak
- 4-voudige beitelhouder
- Wisselwielen set
- Bedieningsleutels
- Afnameprotocol
- Nederlandstalige handleiding, opschriften, CE - kenmerk, en CE-attest volgens Machine richtlijn 2006/42/CE, Laagspanningsrichtlijn 2006/95/CE en EMC Richtlijn 2004/108/CE

Tip: wordt geleverd zonder onderstel 713440409 en zonder tandwielolie 790030020, vergeet deze niet bij te bestellen.

Hoge precieze draaibank voor de veeleisende gebruiker. Vario uitvoering met frequentieomvormer.

Capaciteiten:

- Centerhoogte: 140 mm
- Centerlengte: 700 mm
- Spilboring: 26 mm

Troeven:

- TU2807: 6 snelheden 125 -2000 min-1
- TU2807V: 4 traps variabele toerentalregeling via frequentieomvormer van 30 - 4000 min
- TU2807V: digitale weergave van spilsnelheden.
- Lichtlopende aanvoeraandrijving met afgeronde tandwielen, lopend in een oliebad.
- Met een voedingsas voor draadsnijden of het automatisch langsdraaien.
- Keuzeschakelaar rechts – linksdraaiend

Geschikt voor:

- Vlakdraaien, langs draaien, en draad snijden
- Scholen / opleidingscentra, RenD afdeling, modelbouwer, thuiswerker en doe-het-zelver

Kenmerken:

- Inductie geharde en precisie geslepen prismabed geleidingen
- Gegarandeerde rondloop nauwkeurigheid van de spilneus beter dan 0,009 mm
- Rondloopnauwkeurigheid klauwplaat beter dan 0,05 mm
- Hoge en precieze afwerkingsgraad
- Rolgewalste trapezium leispindel wordt ondersteund door 2 gesinterde lagers.
- Handwielen op de wagen met schaalverdeling 0,04 / 0,01 mm
- Kegellagers in kwaliteit klasse P5
- Druklagers
- Sterk geribd prismabed van gietstaal, inductie gehard en fijn geslepen
- Losse kop kan +/- 5 mm verschoven worden voor het draaien van kegels
- Krachtige, onderhoudsvrije motor

Veiligheden:

- Aparte noodstop, aparte start en stopknop
- Nullastspanning
- Lage voltage bedieningsknoppen
- Microschakelaars in tandwielkast en klauwplaatafscherming
- Beitelafscherming

Order nr.	713427001	713427003	713427006
Algemeen			
Orig. nr.	TU2807 230V	TU2807 400V	TU2807V
Elektrische aansluiting			
Spanning	V	1x230	3x400
Vermogen motor	kW	0,85	0,85
Capaciteit			
Centerhoogte	mm	140	140
Centerafstand	mm	700	700
Draaidiameter boven bed	mm	266	266
Draailengte in de bedbrug	mm	180	180
Bedbreedte	mm	180	180
Kop			
Aantal snelheden		6	6
Spindeltoerental	min-1	150-2.000	150-2.000
Spilkonus	MK	4	4
Spilboring	mm	26	26
Draadstappen en voeding			
Langsvoeding	mm/O	0,07-0,2	0,07-0,2
Draadsnijden metrisch	M	0,2-3,5	0,2-3,5
Draadsnijden duim	Gg/1"	56-8	56-8
Geleiding en wagen			
Rijweg beitelglede	mm	60	60
Rijweg dwarsglede	mm	160	160
Hoogte beitelhouder	mm	13,5	13,5
Losse kop			
Konus losse kop	MK	2	2
Koers losse kop	mm	85	85
Gewicht	kg	180,00	180,00
Afmetingen (l x b x h)	mm	1370 x 640 x 535	1370 x 640 x 535
Prijs	€	2.529,00	2.595,00
			3.179,00

TU2807/TU2807V

ACCESSOIRES

p. 1076-1151

VARIO

700 MM

26MM

140MM

- Hoofdspindel gehard in nastelbare kegelrollagers P5 klasse

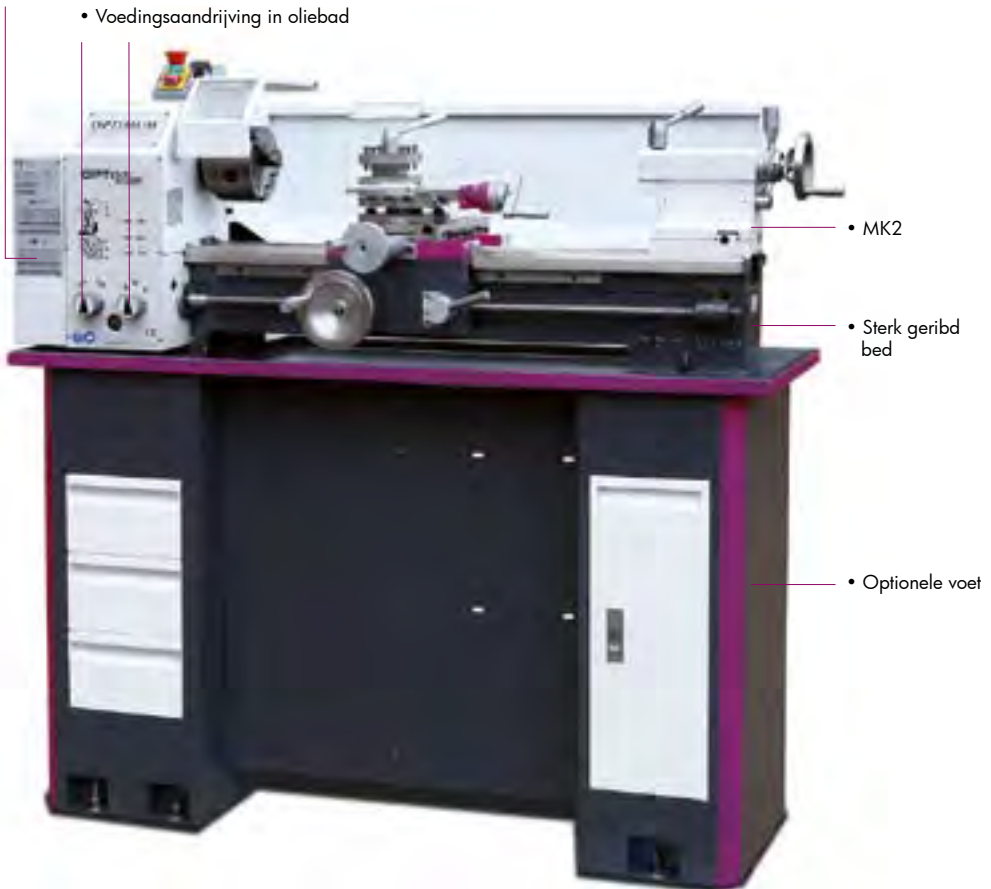

TU2807

Standaard geleverd met:

- Klauwplaat met 3 klauwen 125 mm
- Vast centerpunt MK2
- Vast centerpunt MK4
- Meenemer
- Klauwplaat- en beitel afscherming, spatwand en spanenbak
- 4-voudige beitelhouder
- Wisselwielen set
- Bedieningsleutels
- Afnameprotocol
- Nederlandstalige handleiding, opschriften, CE - kenmerk, en CE-attest volgens Machine richtlijn 2006/42/CE, Laagspanningsrichtlijn 2006/95/CE en EMC Richtlijn 2004/108/CE

Tip: wordt geleverd zonder onderstel 713440409 en zonder tandwielolie 790030020, vergeet deze niet bij te bestellen

Draaibanken

OPTI

Krachtige draaibank met langs- en dwarsvoeding. Vario met borstelloze motor.

Capaciteiten:

- Centelhoogte: 150 mm
- Centerlengte: 800 mm
- Spilboring 38 mm

Troeven:

- Grote doorlaat van ø 38 mm
- Zowel langs- als dwarsvoeding
- Met krachtige motor 1,5 kW (borstelloze Vario)
- Camlockspindel 4

Geschikt voor:

- Voor vlakdraaien, langs- en dwarsdraaien, afsteken, kegeldraaien en draadsnijden
- Thuiswerker, garages voor het afdraaien van remtrommels, opleidingcentra en scholen, algemeen onderhoud, RenD afdeling



Kenmerken:

- Inductie geharde en precisie geslepen prismabed geleidingen
- Gegarandeerde rondloop nauwkeurigheid van de spilneus beter dan 0,009 mm
- Rondloopnauwkeurigheid van de klauwplaat beter dan 0,04 mm
- 5 traps variabele toerentalregeling via frequentieomvormer van 30 - 3000 min (enkel voor Vario model).
- Hoge en precieze afwerkingsgraad
- Sterk geribd prismabed uit grijs gietijzer, inductie gehard en precisie geslepen
- Lichtlopende aanvoeraandrijving met afgeronde tandwielen, lopend in een oliebad.
- Met een voedingsas voor draadsnijden of het automatisch langsdraaien.
- Automatische langs / dwars spilaandrijving
- Alle geleidingen zijn met V spieen nastelbaar
- Keuzeschakelaar rechts – linksdraaiend
- Rolgewalste trapezium leispindel wordt ondersteund door 2 gesinterde lagers.
- Drukklagers
- Losse kop kan +- 5 mm verschoven worden voor het draaien van kegels, met snelklem hendel en precisie aflezing van 0,02 mm
- Voorbereid om meetregels te installeren

Veiligheden:

- Aparte noodstop, aparte start en stopknop
- Nullastspanning; lage voltage bedieningsknopen
- Microschakelaars in tandwielkast en klauwplaatafscherming
- Groot gedimensioneerde beetelafscherming op arm
- Leispil en moerwijs afscherming

MACHINES

Order nr.	713427200 	713427205 
Algemeen		
Orig. nr.	TU3008	TU3008V
Elektrische aansluiting		
Spanning	V	3x400
Vermogen motor	kW	1,5
Capaciteit		
Centerhoogte	mm	150
Centerafstand	mm	800
Draaidiameter boven bed	mm	300
Draaidiameter boven slede	mm	180
Bedbreedte	mm	180
Kop		
Aantal snelheden		6
Spindeltoerental	min-1	150-2000
Spilkonus	MK	5
Spilneus Camlock DIN55029		Camlock No. 4
Spilboring	mm	38
Draadstappen en voeding		
Langsvoeding	mm/O	0,085-0,832
Dwarsvoeding	mm/O	0,01-0,1
Draadsnijden metrisch	M	0,2,3,5
Draadsnijden duim	Gg/1"	56-8
Geleiding en wagen		
Rijweg beetelslede	mm	65
Rijweg dwarslede	mm	150
Hoogte beetelhouder	mm	16x16
Losse kop		
Konus losse kop	MK	3
Koers losse kop	mm	70
Gewicht	kg	260,00
Afmetingen (l x b x h)	mm	1500 x 720 x 690
Prijs	€	3.495,00
		3.975,00

TU3008/TU3008V

ACCESSOIRES

p. 1076-1151

NEW

VARIO

800MM

38MM

150MM

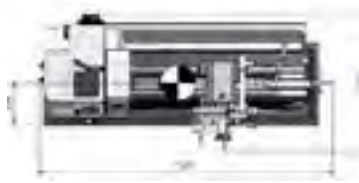

TU3008V

**Standaard geleverd met:**

- Onderstel (niet gemonteerd)
- Klauwplaat met 3 klauwen 160 mm
- Vast centerpunt MK3
- Vast centerpunt MK5
- Reductiehuls
- Klauwplaat- en beitel afscherming, spatwand en spanenplaat
- 4-voudige beitelhouder
- Wisselwielen set
- Bedieningsleutels
- Afnameprotocol
- Nederlandstalige handleiding, opschriften, CE - kenmerk, en CE-attest volgens Machine richtlijn 2006/42/CE, Laagspanningsrichtlijn 2006/95/CE en EMC Richtlijn 2004/108/CE.

Tip: wordt geleverd zonder tandwielolie 790030020, vergeet deze niet bij te bestellen

Compleet uitgeruste lei- en voedings draaibank met een in olie lopende transmissie.
 TH3309D versie met digitale positieaanduiding DPA21 op 3 assen.
 TH3309V versie met variabele toerentalregeling en digitale positieaanduiding DPA21.

Capaciteiten:

- Centerhoogte: 156 mm
- Centerlengte: 910 mm
- Spilboring: 38 mm

Troeven:

- Grote doorlaat van ø 38 mm, camlockspindel 4
- Met krachtige motor 1,5 kW, TH3309V 2,2kW
- Uitneembaar bedbrug voor het draaien van grotere diameters
- LED machineverlichting
- TH3309D en TH3309V met digitale uitlezing op 3 assen gemonteerd
- Met plaat stalen onderstel met opbergruimte en spanenopvangbak

Geschikt voor:

- Voor vlakdraaien, langs- en dwarsdraaien, afsteken, kegeldraaien en draadsnijden
- Thuiswerker, garages voor het afdraaien van rentrommels, opleidingcentra en scholen, algemeen onderhoud, RenD afdeling

Kenmerken:

- Inductie geharde en precisie geslepen prismabed geleidingen
- Gegarandeerde rondloopnauwkeurigheid van de spilneus beter dan 0,015 mm
- Elektrische componenten van Siemens of Schneider
- Alle geleidingen door spieën na stelbaar
- Hoge en precieze afwerkingsgraad
- Lichtlopende aanvoeraandrijving met afgeronde tandwielen, lopend in een oliebad
- TH3309D en TH3309V met digitale uitlezing DPA21 op 3 assen gemonteerd

Veiligheden:

- Aparte noodstop, aparte start- en stopknop
- Nullastspanning; lage voltage 24V bedieningsknopen
- Microschakelaars in tandwielkast en klauwplaatafscherming
- Spatwand en spanenbak; grote beetlafscherming met LED verlichting
- Leispil afscherming; voetbediende noodstop rem

Order nr.	713402030	713402040	713402045
Algemeen			
Orig. nr.	TH3309 400V	TH3309D 400V	TH3309V
Elektrische aansluiting			
Spanning	V	3x400	3x400
Vermogen motor	kW	1.5	1,5
Capaciteit			
Centerhoogte	mm	156	156
Centerafstand	mm	910	910
Draaidiameter boven bed	mm	350	350
Draaidiameter boven slede	mm	196	196
Draaidiameter zonder bedbrug	mm	430	430
Draailengte in de bedbrug	mm	230	230
Bedbreedte	mm	181	181
Kop			
Aantal snelheden		8	8
Spindeltoerental	min-1	60-2000	60-2000
Spilkonus	MK	5	5
Spilneus Camlock DIN55029		D1-4"	D1-4"
Spilboring	mm	38	38
Draadstappen en voeding			
Langsvoeding	mm/O	0,052-1,592 (32)	0,052-1,392 (32)
Dwarsvoeding	mm/O	0,014-0,38 (32)	0,014-0,58 (32)
Draadsnijden metrisch	M	0,4-7 (26)	0,4-7 (26)
Draadsnijden duim	Gg/1"	56-4 (34)	56-4 (34)
Geleiding en wagen			
Rijweg beetelslede	mm	98	98
Rijweg dwarslede	mm	164	164
Hoogte beetelhouder	mm	16x16	16x16
Losse kop			
Konus losse kop	MK	3	3
Koers losse kop	mm	110 (ø 32)	110 (ø 32)
Gewicht	kg	430,00	430,00
Afmetingen (l x b x h)	mm	1635 x 745 x 1320	1635 x 745 x 1590
Prijs	€	4.890,00	5.950,00
			7.790,00

TH3309/TH3309D/TH3309V

ACCESSOIRES

p. 1076-1151

NEW

VARIO

910 MM

38MM

156MM

**Standaard geleverd met:**

- Reductiehuls MK5 - MK3
- 2 Vaste centers MK3
- Vaste bril met doorlaat van 19-70 mm
- Volg bril met doorlaat van 16-50 mm
- 4-voudige beitelhouder
- Draadsnijblok
- Wisselwielen set
- Bedieningsleutels
- Afnameprotocol
- Nederlandstalige handleiding, opschriften, CE - kenmerk, en CE-attest volgens Machine richtlijn 2006/42/CE, Laagspanningsrichtlijn 2006/95/CE en EMC Richtlijn 2004/108/CE

Tip: wordt geleverd zonder tandwielolie 790030020, en zonder klauwplaten vergeet deze niet bij te bestellen. Installatie, ingebruikname en scholing door gekwalificeerde technici op aanvraag



Compleet uitgeruste lei- en voedingsas draaibank met een in olie lopende transmissie. TH3610D versie met digitale positieaanduiding DPA21 op 3 assen.

Troeven:

- Grote doorlaat van \varnothing 52 mm, camlockspindel 5
- Met krachtige motor 1,5 kW
- Uitneembare bedbrug voor het draaien van grotere diameters
- LED machineverlichting
- TH3610D met digitale uitlezing op 3 assen gemonteerd
- Plaatstalen onderstel met opbergruimte en spanenopvangbak

Geschikt voor:

- Voor vlakdraaien, langs- en dwarsdraaien, afsteken, kegeldraaien en draadsnijden
- Thuiswerker, garages voor het afdraaien van remtrommels, opleidingscentra en scholen, algemeen onderhoud, RenD afdeling

Kenmerken:

- Inductie geharde en precisie geslepen prismabed geleidingen
- Gegarandeerde rondloopnauwkeurigheid van de spilneus beter dan 0,015 mm
- Elektrische componenten van Siemens of Schneider
- Alle geleidingen door spieën na stelbaar.
- Hoge en precieze afwerkingsgraad
- Lichtlopende aanvoeraandrijving met afgeronde tandwielen, lopend in een oliebad.
- TH3610D met digitale uitlezing DPA21 op 3 assen gemonteerd

Veiligheden:

- Aparte noodstop, aparte start en stopknop
- Nullastspanning; lage voltage 24V bedieningsknopen
- Microschakelaars in tandwielkast en klauwplaatafscherming
- Spatwand en spanenbak, grote beetelafscherming met LED verlichting
- Leispil afscherming; voetbediende noodstop rem.

Order nr.	713402050	713402060
Algemeen		
Orig. nr.	TH3610 400V	TH3610D 400V
Elektrische aansluiting		
Spanning	V 3x400	3x400
Vermogen motor	kW 1.5	1.5
Capaciteit		
Centerhoogte	mm 180	180
Centerafstand	mm 1000	1000
Draaidiameter boven bed	mm 356	356
Draaidiameter boven slede	mm 198	198
Draaidiameter zonder bedbrug	mm 516	516
Draailengte in de bedbrug	mm 160	160
Bedbreedte	mm 187	187
Kop		
Aantal snelheden	8	8
Spindeltoerental	min-1 70-2000	70-2000
Spilkonus	MK 6	6
Spilneus Camlock DIN55029	D1-5"	D1-5"
Spilboring	mm 52	52
Draadstappen en voeding		
Langsvoeding	mm/O 0.052-1.392	0.052-1.392
Dwarsvoeding	mm/O 0.014-0.38	0.014-0.38
Draadsnijden metrisch	M 0.4-7	0.4-7
Draadsnijden duim	Gg/1" 56-4	56-4
Geleiding en wagen		
Rijweg beetelslede	mm 100	100
Rijweg dwarslede	mm 170	170
Hoogte beetelhouder	mm 16x16	16x16
Losse kop		
Konus losse kop	MK 3	3
Koers losse kop	mm 120 (\varnothing 42)	120 (\varnothing 42)
Gewicht	kg 610,00	610,00
Afmetingen (l x b x h)	mm 1820 x 680 x 1320	1820 x 680 x 1590
Prijs	€ 5.990,00	7.090,00

TH3610/TH3610D

ACCESSOIRES

p. 1076-1151

NEW

1000MM

52MM

180MM

**Standaard geleverd met:**

- Reductiehuls MK6 - MK4
- 2 Vaste centers MK4
- Vaste bril met doorlaat van max. 100 mm
- Volg bril met doorlaat van max. 95 mm
- 4-voudige beitelhouder
- Draadsnijlok
- Wisselwielen set
- Bedieningsleutels
- Afnameprotocol
- Nederlandstalige handleiding, opschriften, CE - kenmerk, en CE-attest volgens Machine richtlijn 2006/42/CE, Laagspanningsrichtlijn 2006/95/CE en EMC Richtlijn 2004/108/CE

Tip: wordt geleverd zonder tandwielolie 790030020, en zonder klauwplaten vergeet deze niet bij te bestellen. Installatie, ingebruikname en scholing door gekwalificeerde technici op aanvraag

Compleet uitgeruste lei- en voedingsas draaibank met een in olie lopende transmissie. TH4010D versie met digitale positieaanduiding DPA21 op 3 assen.

Capaciteiten:

- Centerhoogte: 205 mm
- Centerlengte: 1000 mm
- Spilboring: 52 mm

Troeven:

- Grote doorlaat van \varnothing 52 mm, camlockspindel 5
- Gesloten koelvloeistofsysteem met koelpomp
- Met krachtige tweesnelheidsmotor 1,5/2,4 kW
- Uitneembaar bedbrug voor het draaien van grotere diameters
- LED machineverlichting
- TH4010D met digitale uitlezing op 3 assen gemonteerd
- Plaatstalen onderstel met opbergruimte en spanenopvangbak

Geschikt voor:

- Vlakdraaien, langs- en dwarsdraaien, afsteken, kegeldraaien en draadsnijden
- Thuiswerker, garages voor het afdraaien van remtrommels, opleidingscentra en scholen, algemeen onderhoud, RenD afdeling

Kenmerken:

- Inductie geharde en precisie geslepen prismabed geleidingen
- Gegarandeerde rondloopnauwkeurigheid van de spilneus beter dan 0,015 mm
- Elektrische componenten van Siemens of Schneider
- Alle geleidingen door spieën na stelbaar.
- Hoge en precieze afwerkingsgraad
- Lichtlopende aanvoeraandrijving met afgeronde tandwielen, lopend in een oliebad.
- TH4010D met digitale uitlezing DPA21 op 3 assen gemonteerd

Veiligheden

- Aparte noodstop, aparte start en stopknop
- Nullastspanning; lage voltage 24 V bedieningsknopen
- Microschakelaars in tandwielkast en klauwplaat afscherming
- Spatwand en spanenbak; grote beetelafscherming met LED verlichting
- Leispijlf afscherming; voetbediende noodstop rem

Order nr.		713402070	713402080
Algemeen			
Orig. nr.		TH4010 400V	TH4010D 400V
Elektrische aansluiting			
Spanning	V	3x400	3x400
Vermogen motor	kW	1.5/2.4	1.5/2.4
Capaciteit			
Centerhoogte	mm	205	205
Centerafstand	mm	1000	1000
Draaidiameter boven bed	mm	410	410
Draaidiameter zonder bedbrug	mm	540	540
Draailengte in de bedbrug	mm	165	165
Bedbreedte	mm	206	206
Kop			
Aantal snelheden		16	16
Spindeltoerental	min-1	45-1800	45-1800
Spilkonus	MK	6	6
Spilneus Camlock DIN55029		D1-5"	D1-5"
Spilboring	mm	52	52
Draadstappen en voeding			
Langsvoeding	mm/O	0.043-0.653 (48 st)	0.043-0.653
Dwarsvoeding	mm/O	0.015-0.206 (48 st)	0.015-0.206
Draadsnijden metrisch	M	0.4-7 (42)	0.4-7
Draadsnijden duim	Gg/1"	70-4	70-4
Geleiding en wagen			
Rijweg beetelslede	mm	100	100
Rijweg dwarslede	mm	195	195
Hoogte beetelhouder	mm	16x16	16x16
Losse kop			
Konus losse kop	MK	3	3
Koers losse kop	mm	130 (\varnothing 45)	130 (\varnothing 45)
Gewicht	kg	750,00	750,00
Afmetingen (l x b x h)	mm	1920 x 740 x 1252	1920 x 740 x 1585
Prijs	€	8.390,00	9.390,00

TH4010/TH4010D

ACCESSOIRES

p. 1076-1151

NEW

1000MM

52MM

205MM

**Standaard geleverd met :**

- Reductiehuls MK6 - MK4
- 2 Vaste centers MK4
- Vaste bril met doorlaat van max. 100 mm
- Volg bril met doorlaat van max. 95 mm
- 4-voudige beitelhouder
- Draadsnijblok
- Wisselwielen set
- Bedieningsleutels
- Afnameprotocol
- Nederlandstalige handleiding, opschriften, CE - kenmerk, en CE-attest volgens Machine richtlijn 2006/42/CE, Laagspanningsrichtlijn 2006/95/CE en EMC Richtlijn 2004/108/CE

Tip: wordt geleverd zonder tandwielolie 790030020, en zonder klauwplaten vergeet deze niet bij te bestellen. Installatie, ingebruikname en scholing door gekwalificeerde technici op aanvraag

TH46 serie. Compleet uitgeruste precisie lei- en voedingsas draaibank en digitale positieaanduiding DPA21 op 3 assen.

Troeven:

- Hoogwaardig gietijzeren onderstel
- Uiterst krachtige, onderhoudsvrije motor van 5,5 kW
- Gesloten koelvloeistofstelsysteem met koelpomp
- Uitneembaar bedbrug voor het draaien van grotere diameters
- Ingebouwde machineverlichting in beetelafscherming
- Met digitale uitlezing op 3 assen gemonteerd
- 40 positie snelwissel beetelhouder SWH5-B met 1 vierkante beetelhouder

Geschikt voor:

- Vlakdraaien, langs- en dwarsdraaien, afsteken, kegeldraaien en draadsnijden
- Algemeen onderhoud, opleidingscentra en scholen, herstel van landbouwmachines

Kenmerken:

- Spindelopname Camlock DIN ISO 7022 Nr. 6
- Gegarandeerde rondloopnauwkeurigheid van de spilneus beter dan 0,015 mm
- Sterk geribd prismabed uit grijsgietijzer, inductie gehard en precisie geslepen
- Geharde spilneus en gelagerd in na stelbare kegelkogellagers klasse P5 kwaliteit
- Tandwielen en assen zijn gehard en geslepen, lopend in een oliebad met precisie lagers
- Rechts / links lopend door middel van hendel aan de wagen
- Centraal smeersysteem voor het bed
- De elektrische routing loopt in een kabelgoot, dus geen loshangende kabels in de koelvloeistof, alsook een mooie geleidingen van de elektrische kabels van de wagen
- Elektrische componenten van Siemens of Schneider
- Alle geleidingen door spieën na stelbaar
- Losse kop kan + 15 mm verplaatst worden voor het draaien van kegels, met snelklemming van de losse kop voor een nog betere klemming
- Met digitale uitlezing DPA21 op 3 assen gemonteerd

Order nr.		713462110	713462120	713462130
Algemeen				
Orig. nr.		TH4610	TH4615	TH4620
Elektrische aansluiting				
Spanning	V	3x400	3x400	3x400
Vermogen motor	kW	5,5	5,5	5,5
Vermogen motor koelpomp	W	100	100	100
Capaciteit				
Centerhoogte	mm	230	230	230
Centerafstand	mm	1000	1500	2000
Draaidiameter boven bed	mm	465	465	465
Draaidiameter boven slede	mm	270	270	270
Draaidiameter zonder bedbrug	mm	690	690	690
Draailengte in de bedbrug	mm	240	240	240
Bedbreedte	mm	300	300	300
Kop				
Aantal snelheden		12	12	12
Spindeltoerental	min-1	25-2000	25-2000	25-2000
Spilkonus	MK	6	6	6
Spilneus Camlock DIN55029		Camlock N° 6	Camlock N° 6	Camlock N° 6
Spilboring	mm	58	58	58
Draadstappen en voeding				
Langsvoeding	mm/O	0,031-1.7 (42)	0,031-1,7	0,031-1.7 (42)
Dwarsvoeding	mm/O	0,014-0,784	0,014-0,784	0,014-0,784 (42)
Draadsnijden metrisch	M	0.1-14 (41)	0,1-14	0.1-14 (41)
Draadsnijden duim	Gg/1"	1122 (41)	1122	1122 (41)
Trapeziumdraad	D.P.	4-112 (50)	4-112	4-112 (50)
Modulaire draad	M.P.	0.1-7 (34)	0,1-7	0.1-7 (54)
Geleiding en wagen				
Rijweg beetelslede	mm	125	125	125
Rijweg dwarslede	mm	285	285	285
Hoogte beetelhouder	mm	25x25	25x25	25x25
Losse kop				
Konus losse kop	MK	4	4	4
Koers losse kop	mm	130	130	130
Gewicht	kg	1720,00	1977,00	2400,00
Afmetingen (l x b x h)	mm	2200 x 1245 x 1568	2750 x 1245 x 1568	3250 x 1245 x 1568
Prijs	€	13.750,00	15.760,00	16.990,00

TH4610/TH4615/TH4620

ACCESSOIRES

p. 1076-1151

NEW

1000/1500/
2000MM

58MM

220MM

**Veiligheden**

- Aparte noodstop, aparte start en stopknop
- Nullastspanning; lage voltage 24V bedieningsknopen
- Microschakelaars in tandwielkast en klauwplaatafscherming
- Spatwand en spanenbak, grote beetlafscherming met verlichting
- Leispil afscherming; voetbediende noodstop rem

Standaard geleverd met:

- Reductiehuls MK6 - MK4
- 2 vaste centers MK4
- Vaste bril
- Volg bril
- Draadsnijlklok
- Wisselwielen set
- Bedieningsleutels
- Afnameprotocol
- Nederlandstalige handleiding, opschriften, CE - kenmerk, en CE-attest volgens Machine richtlijn 2006/42/CE, Laagspanningsrichtlijn 2006/95/CE en EMC Richtlijn 2004/108/CE

Tip: wordt geleverd zonder tandwielolie 790030020 (20 liter nodig), en zonder klauwplaten vergeet deze niet bij te bestellen. Installatie, ingebruikname en scholing door gekwalificeerde technici op aanvraag



TH4615V. Compleet uitgeruste precisie lei- en voedingsas draaibank met **Siemens inverter** vario aandrijving en digitale positieaanduiding DPA21 op 3 assen.

Troeven:

- 2 traps elektronisch regelbare spilsnelheden 30 - 400 / 160 - 2000 min-1
- Hoogwaardig gietijzeren onderstel
- Uiterst krachtige, onderhoudsvrije motor van 7,5 kW
- Grote doorlaat van 80 mm
- Gesloten koelvloeistofstelsysteem met koelpomp
- Ingebouwde machineverlichting in beitelafscherming
- Met digitale uitlezing op 3 assen gemonteerd
- 40 positie snelwissel beitelhouder SWH5-B met 1 vierkante beitelhouder

Geschikt voor:

- Vlakdraaien, langs- en dwarsdraaien, afsteken, kegeldraaien en draadsnijden
- Algemeen onderhoud en industrie, opleidingscentra en scholen, herstel van landbouwmachines

Kenmerken:

- Spindelopname Camlock DIN ISO 7022 Nr. 8
- Gegarandeerde rondlooptrouwbaarheid van de spilneus beter dan 0,015 mm
- Sterk geribd prismabed uit grijsgietijzer, inductie gehard en precisie geslepen
- Geharde spilneus en gelagerd in na stelbare kegelkogellagers klasse P5 kwaliteit
- Tandwielen en assen zijn gehard en geslepen, lopend in een oliebad met precisie lagers
- Rechts / links lopend door middel van hendel aan de wagen
- Centraal smeersysteem voor het bed
- De elektrische routing loopt in een kabelgoot, dus geen loshangende kabels in de koelvloeistof, alsook een mooie geleidingen van de elektrische kabels van de wagen
- Elektrische componenten van Siemens of Schneider
- Alle geleidingen door spieën na stelbaar
- Losse kop kan +- 15 mm verplaatst worden voor het draaien van kegels, met snelklemming van de losse kop voor een nog betere klemming
- Met digitale uitlezing DPA21 op 3 assen gemonteerd

• Frequentieomvormer Sinamics G120D:

Order nr.	713462125	
Algemeen		
Orig. nr.		TH4615V
Elektrische aansluiting		
Spanning	V	3x400
Vermogen motor	kW	7,5
Vermogen motor koelpomp	W	100
Capaciteit		
Centerhoogte	mm	230
Centerafstand	mm	1500
Draaidiameter boven bed	mm	465
Draaidiameter boven slede	mm	270
Draaidiameter zonder bedbrug	mm	690
Draailengte in de bedbrug	mm	240
Bedbreedte	mm	300
Kop		
Aantal snelheden		traploos (2 traps)
Spindeltoerental	min-1	30-400 / 160-2000
Spilkonus	MK	7
Spilneus Camlock DIN55029		D1-8"
Spilboring	mm	80
Draadstappen en voeding		
Langsvoeding	mm/O	0,031-1,7
Dwarsvoeding	mm/O	0,014-0,784
Draadsnijden metrisch	M	0,1-14
Draadsnijden duim	Gg/1"	1122
Trapeziumdraad	D.P.	4-112
Modulaire draad	M.P.	0,1-7
Geleiding en wagen		
Rijweg beitelplede	mm	128
Rijweg dwarsplede	mm	285
Hoogte beitelhouder	mm	25x25
Losse kop		
Konus losse kop	MK	4
Koers losse kop	mm	130
Gewicht	kg	1980,00
Afmetingen (l x b x h)	mm	2750 x 1245 x 1568
Prijs	€	21.990,00

TH4615V

ACCESSOIRES

p. 1076-1151

NEW

VARIO

1500MM

80MM

230MM

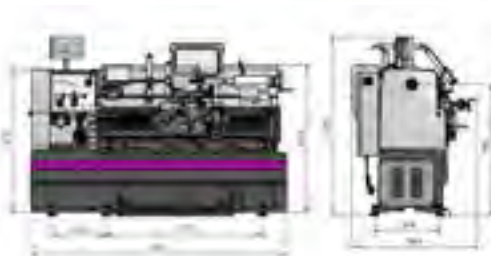

MACHINES

Veiligheden:

- Aparte noodstop, aparte start en stopknop
- Nullastspanning; lage voltage 24V bedieningsknopen
- Toerentalbewaking volgens de machinerichtlijn. EMV filter klasse 2 voor de inzet in verschillende gebieden
- Microschakelaars in tandwielkast en klauwplatafscherming
- Spatwand en spanenbak; grote beitelfascherming met verlichting
- Leispil afscherming; voetbediende noodstop rem

Standaard geleverd met:

- Reductiehuls MK6 - MK4
- 2 Vaste centers MK4
- Vaste bril
- Volg bril
- Draadsnijblok
- Wisselwielen set
- Bedieningsleutels
- Afnameprotocol
- Nederlandstalige handleiding, opschriften, CE - kenmerk, en CE-attest volgens Machine richtlijn 2006/42/CE, Laagspanningsrichtlijn 2006/95/CE en EMC Richtlijn 2004/108/CE

Tip: wordt geleverd zonder tandwielolie 790030020 (20 liter nodig), en zonder klauwplaten vergeet deze niet bij te bestellen. Installatie, ingebruikname en scholing door gekwalificeerde technici op aanvraag

TH56 serie. Compleet uitgeruste precisie lei- en voedingsas draaibank en digitale positieaanduiding DPA21 op 3 assen.

Troeven:

- Hoogwaardig gietijzeren onderstel
- Uiterst krachtige, onderhoudsvrije motor van 7,5 kW
- Grote doorlaat van 80 mm
- Gesloten koelvloestofstelsysteem met koelpomp
- Uitneembare bedbrug voor het draaien van grotere diameters
- Ingebouwde machineverlichting in beitelafscherming
- Met digitale uitlezing op 3 assen gemonteerd
- 40 positie snelwissel beitelhouder SWH7-C met 1 vierkante beitelhouder

Geschikt voor:

- Voor vlakdraaien, langs- en dwarsdraaien, afsteken, kegeldraaien en draadsnijden
- Algemeen onderhoud; opleidingcentra en scholen, herstel van landbouwmachines

Kenmerken:

- Spindelopname Camlock DIN ISO 7022 Nr. 8
- Gegarandeerde rondloopnauwkeurigheid van de spilneus beter dan 0,015 mm
- Sterk geribd prismabed uit grijsgietijzer, inductie gehard en precisie geslepen
- Geharde spilneus en gelagerd in na stelbare kegelkogellagers klasse P5 kwaliteit.
- Tandwielen en assen zijn gehard en geslepen, lopend in een oliebad met precisie lagers
- Rechts / links lopend door middel van hendel aan de wagen
- Centraal smeersysteem voor het bed
- De elektrische routing loopt in een kabelgoot, dus geen loshangende kabels in de koelvloestof, alsook een mooie geleidingen van de elektrische kabels van de wagen
- Elektrische componenten van Siemens of Schneider
- Alle geleidingen door spieën na stelbaar
- Losse kop kan +/- 15 mm verplaatst worden voor het draaien van kegels, met snelklemming van de losse kop voor een nog betere klemming
- Met digitale uitlezing DPA21 op 3 assen gemonteerd

Order nr.	713462160	713462170	713462180
Algemeen			
Orig. nr.	TH5615	TH5620	TH5630
Elektrische aansluiting			
Spanning	V 3x400	3x400	3x400
Vermogen motor	kW 7,5	7,5	7,5
Vermogen motor koelpomp	W 100	100	100
Capaciteit			
Centerhoogte	mm 280	280	280
Centerafstand	mm 1500	2000	3000
Draaidiameter boven bed	mm 560	560	560
Draaidiameter boven slede	mm 355	355	355
Draaidiameter zonder bedbrug	mm 790	790	790
Draailengte in de bedbrug	mm 270	270	270
Bedbreedte	mm 350	350	350
Kop			
Aantal snelheden	12	12	12
Spindeltoerental	min-1 25-1600	25-1600	25-1600
Spilkonus	MK 7	7	7
Spilneus Camlock DIN55029	D1-8" 80	D1-8" 80	D1-8" 80
Spilboring	mm 80	80	80
Draadstappen en voeding			
Langsvoeding	mm/O 0,059-1,646 (35)	0,059-1,646 (35)	0,059-1,646 (35)
Dwarsvoeding	mm/O 0,020-0,573 (35)	0,020-0,573 (35)	0,020-0,573 (35)
Draadsnijden metrisch	M 0,2-14 (47)	0,2-14 (47)	0,2-14 (47)
Draadsnijden duim	Gg/1" 1122 (60)	1122 (60)	1122 (60)
Trapeziumdraad	D.P. 4-112 (50)	4-112 (50)	4-112 (50)
Modulaire draad	M.P. 0,1-7 (34)	0,1-7 (34)	0,1-7 (34)
Geleiding en wagen			
Rijweg beitelplede	mm 130	130	130
Rijweg dwarsplede	mm 316	316	316
Hoogte beitelhouder	mm 32x32	32x32	32x32
Losse kop			
Konus losse kop	MK 5	5	5
Koers losse kop	mm 180	180	180
Gewicht	kg 2302,00	2720,00	3000,00
Afmetingen (l x b x h)	mm 2840 x 1150 x 1460	3340 x 1150 x 1460	4340 x 1150 x 1460
Prijs	€ 17.710,00	19.470,00	23.270,00

TH5615/TH5620/TH5630

ACCESSOIRES
p. 1076-1151

NEW

1000/1500/
2000MM

80MM

280MM



- Digitale aflezing DPA21 op 3 assen

- Kwaliteit klauwplaat: precies, hoger toerentalbereik

- Grote beetelafscherming

- 40 positie snelwisselhouder

- Tegenpunt MK5 +/- 15mm verstelbaar

TH5620 met optionele klauwpaat

- Hoofdspindel:
 - Gehard en geslepen
 - In een oliebad
 - Met 2 instelbare precisie kegellagers
 - Hoogwaardige GATES aandrijfriemen
- Voetrem
- Wagen:
 - Precies bewerkt
 - Handwielen instelbaar met fijnafstelling 0,04/0,02mm
 - Alle geleidingen nastelbaar met spieën
- Gietijzeren machineonderstel

Veiligheden:

- Aparte noodstop, aparte start en stopknop
- Nullastspanning; lage voltage 24V bedieningsknoppen
- Microschakelaars in tandwielkast en klauwplaatafscherming
- Spatwand en spanenbak, grote beetelafscherming met verlichting
- Leispil afscherming; voetbediende noodstop rem

Standaard geleverd met:

- Reductiehuls MK7 - MK5
- 2 Vaste centers MK5
- Vaste bril
- Volg bril
- Draadsnijlklok
- Wisselwielen set
- Bedienings sleutels
- Afnameprotocol
- Nederlandstalige handleiding, opschriften, CE - kenmerk, en CE-attest volgens Machine richtlijn 2006/42/CE, Laagspanningsrichtlijn 2006/95/CE en EMC Richtlijn 2004/108/CE

Tip: wordt geleverd zonder tandwielolie 790030020 (20 liter nodig), en zonder klauwplaten vergeet deze niet bij te bestellen. Installatie, ingebruikname en scholing door gekwalificeerde technici op aanvraag

TH5620V. Compleet uitgeruste precisie lei- en voedingsas draaibank met **Siemens inverter** vario aandrijving en digitale positieaanduiding DPA21 op 3 assen.

Troeven:

- 2 traps elektronisch regelbare spilsnelheden 25 - 200 / 200 - 1600 min-1
- Hoogwaardig gietijzeren onderstel
- Uiterst krachtige, onderhoudsvrije motor van 7,5 kW
- Grote doorlaat van 105 mm
- Gesloten koelvloeistofsysteem met koelpomp
- Ingebouwde machineverlichting in beitelafscherming
- Met digitale uitlezing op 3 assen gemonteerd
- 40 positie snelwissel beitelhouder SWH7C met 1 vierkante beitelhouder

Geslacht voor:

- Voor vlakdraaien, langs- en dwarsdraaien, afsteken, kegeldraaien en draadsnijden
- Algemeen onderhoud en industrie
- Opleidingcentra en scholen
- Herstel van landbouwmachines

Kenmerken;

- Spindelopname Camlock DIN ISO 7022 Nr. 8
- Gegarandeerde rondlooppauwkeurigheid van de spilneus beter dan 0,015 mm
- Sterk geribd prismabed uit grijsgietijzer, inductie gehard en precisie geslepen
- Geharde spilneus en gelagerd in na stelbare kegelskogellagers klasse P5 kwaliteit
- Tandwielen en assen zijn gehard en geslepen, lopend in een oliebad met precisie lagers
- Rechts / links lopend door middel van hendel aan de wagen
- Centraal smeersysteem voor het bed
- De elektrische routing loopt in een kabelgoot, dus geen loshangende kabels in de koelvloeistof, alsook een mooie geleidingen van de elektrische kabels van de wagen
- Elektrische componenten van Siemens of Schneider
- Alle geleidingen door spieën na stelbaar
- Losse kop kan +/- 15 mm verplaatst worden voor het draaien van kegels, met snelklemming van de losse kop voor een nog betere klemming
- Met digitale uitlezing DPA21 op 3 assen gemonteerd

Order nr.	713462175	
Algemeen		
Orig. nr.	TH5620V	
Elektrische aansluiting		
Spanning	V	3x400
Vermogen motor	kW	7.5
Capaciteit		
Centerhoogte	mm	280
Centerafstand	mm	2000
Draaidiameter boven bed	mm	560
Draaidiameter boven slede	mm	355
Draaidiameter zonder bedbrug	mm	785
Draailengte in de bedbrug	mm	150
Bedbreedte	mm	350
Kop		
Aantal snelheden	2-traps, variabel	
Spindeltoerental	min-1	25-1600
Spilneus Camlock DIN55029	8	
Spilboring	mm	105
Draadstappen en voeding		
Langsvoeding	mm/O	0.059 - 1.646
Dwarsvoeding	mm/O	0.020 - 0.573
Draadsnijden metrisch	M	0.2 - 14
Draadsnijden duim	Gg/1"	112 - 2
Trapeziumdraad	D.P.	112 - 4
Modulaire draad	M.P.	0.1 - 7
Geleiding en wagen		
Rijweg beitel slede	mm	130
Rijweg dwars slede	mm	310
Hoogte beitelhouder	mm	25 x 25
Losse kop		
Konus losse kop	MK	5
Koers losse kop	mm	180
Gewicht	kg	2720,00
Afmetingen (l x b x h)	mm	3340 x 1150 x 1460
Prijs	€	27.280,00

TH5620V

ACCESSOIRES

p. 1076-1151

NEW

VARIO

1500MM

Ø105MM

280MM



MACHINES

Veiligheden:

- Aparte noodstop, aparte start en stopknop
- Nullastspanning
- Toerentalbewaking volgens de machinerichtlijn. EMV filter klasse 2 voor de inzet in verschillende gebieden
- Lage voltage 24V bedieningsknopen
- Microschakelaars in tandwielkast en klauwplaatafscherming
- Spatwand en spanenbak
- Grote beitelaafscherming met verlichting
- Leispil afscherming
- Voetbediende noodstop rem

Standaard geleverd met:

- Reductiehuls MK7 - MK5
- 2 Vaste centers MK5
- Vaste bril
- Volg bril
- Draadsnijkklok
- Wisselwielen set
- Bedieningsleutels
- Afnameprotocol
- Nederlandstalige handleiding, opschriften, CE - kenmerk, en CE-attest volgens Machine richtlijn 2006/42/CE, Laagspanningsrichtlijn 2006/95/CE en EMC Richtlijn 2004/108/CE

Tip: wordt geleverd zonder tandwielolie 790030020 (20 liter nodig), en zonder klauwplaten vergeet deze niet bij te bestellen. Installatie, ingebruikname en scholing door gekwalificeerde technici op aanvraag

Compleet uitgeruste lei- en voedingsas draaibank met een in olie lopende transmissie. DPA-versie met digitale positieaanduiding DPA2000 op 3 assen.

Troeven:

- Grote doorlaat van \varnothing 38 mm, camlockspindel 4
- Zowel langs- als dwarsvoeding
- Met krachtige motor 1,5 kW
- Uitneembare bedbrug voor het draaien van grotere diameters
- Halogeen machineverlichting
- Verie met DPA met digitale uitlezing op 3 assen gemonteerd
- Plaatstalen onderstel en spatwand (niet gemonteerd)

Geschikt voor:

- Vlakdraaien, langs- en dwarsdraaien, afsteken, kegeldraaien en draadsnijden
- Thuiswerker, garages voor het afdraaien van remtrommels, opleidingcentra en scholen, algemeen onderhoud, RenD afdeling

Kenmerken:

- Inductie geharde en precisie geslepen prismabed geleidingen
- Gegarandeerde rondloopnauwkeurigheid van de spilneus beter dan 0,015 mm
- Elektrische componenten van Siemens
- Alle geleidingen door spieën nastelbaar
- Hoge en precieze afwerkingsgraad
- Lichtlopende aanvoeraandrijving met afgeronde tandwielen, lopend in een oliebad.
- Digitale uitlezing DPA2000 op 3 assen gemonteerd (enkel DPA versie)
- Keuzeschakelaar rechts – linksdraaiend
- Rolgewalste trapezium leispindel wordt ondersteund door 2 gesinterde lagers
- Losse kop kan +/- 10 mm verschoven worden voor het draaien van kegels

Veiligheden:

- Aparte noodstop, aparte start en stopknop
- Nullastspanning; lage voltage bedieningsknopen
- Microschakelaars in tandwielkast en klauwplaatafscherming
- Spatwand en spanenbak; beitelfafscherming; leispil afscherming

Order nr.

713400928

Algemeen

Orig. nr.

D320X920 DPA 400V

Elektrische aansluiting

Spanning	V	3x400
Vermogen motor	kW	1,5

Capaciteit

Centerhoogte	mm	160
Centerafstand	mm	920
Draaidiameter boven bed	mm	320
Draaidiameter boven slede	mm	190
Draaidiameter zonder bedbrug	mm	430
Draailengte in de bedbrug	mm	230
Bedbreedte	mm	181

Kop

Aantal snelheden		18
Spindeltoerental	min-1	65 - 1.800
Spilkonus	MK	5
Spilneus Camlock DIN55029		D1-4"
Spilboring	mm	38

Draadstappen en voeding

Langsvoeding	mm/O	0,052-1,392 (32)
Dwarsvoeding	mm/O	0,014-0,380 (32)
Draadsnijden metrisch	M	0,4-7 (26)
Draadsnijden duim	Gg/1"	56-4 (34)

Geleiding en wagen

Rijweg beitelslede	mm	85
Rijweg dwarslede	mm	162
Hoogte beitelhouder	mm	16

Losse kop

Konus losse kop	MK	3
Koers losse kop	mm	100
Gewicht	kg	410,00
Afmetingen (l x b x h)	mm	1685 x 750 x 1550

Prijs

€ **5.590,00**

D320x920 DPA

ACCESSOIRES
p. 1076-1151

920MM

38MM

160MM

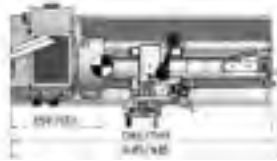
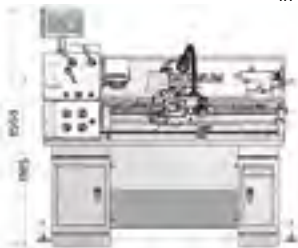

Standaard geleverd met:

- Zelfcenterende klauwplaat met 3 klauwen \varnothing 160 mm rechtstreekse koppeling directe montage (zonder gebruik van flens)
- Onafhankelijke vierbekken plaat \varnothing 200 mm rechtstreekse koppeling directe montage (zonder gebruik van flens)
- Vlakplaat \varnothing 250 mm
- Reductiehuls MK5 - MK3
- 2 Vaste centers MK3
- Vaste bril met doorlaat van maximum 70 mm
- Volg bril met doorlaat van maximum 50 mm
- 4-voudige beitelhoeder
- Draadsnijlok
- Wisselwielen set
- Bedieningssleutels
- Afnameprotocol
- Nederlandstalige handleiding, opschriften, CE - kenmerk, en CE-attest volgens Machine richtlijn 2006/42/CE, Laagspanningsrichtlijn 2006/95/CE en EMC Richtlijn 2004/108/CE

Tip: wordt geleverd zonder tandwielolie 790030020, vergeet deze niet bij te bestellen. Installatie, ingebruikname en scholing door gekwalificeerde technici op aanvraag



Precisie lei- en voedingsas draaibank. Uitgekiende techniek en volledig uitgerust.

Troeven:

- Uit één stuk gegoten Meehaniet gietijzeren machineonderstel
- Uiterst krachtige, onderhoudsvrije motor van 4,5 kW
- Gesloten koelvloeistofsysteem met koelpomp
- Uitneembaar bedbrug voor het draaien van grotere diameters
- Halogeen machineverlichting
- Met digitale uitlezing DPA2000 op 3 assen gemonteerd

Geschikt voor:

- Vlakdraaien, langs- en dwarsdraaien, afsteken, kegeldraaien en draadsnijden
- Algemeen onderhoud
- Opleidingcentra en scholen

Kenmerken:

- Camlock spilneus ASA D1-6" volgens DIN55029
- Alle geleidingen door spieën nastelbaar
- In een oliebad lopende hoofdspindel, gehard en geslepen met twee afstelbare precisie kogellagers. Geharde en geslepen tandwielen en assen, precisielopend in een oliebad
- Keuzeschakelaar rechts – linksdraaiend
- Sterk geribd prismabed van gietstaal (GG30), inductie gehard en fijn geslepen
- Losse kop kan +/- 13 mm verschoven worden voor het draaien van kegels

Veiligheden:

- Aparte noodstop, aparte start en stopknop
- Nullastspanning; lage voltage 24V bedieningsknopen
- Microschakelaars in tandwielkast en klauwplaatafscherming
- Spatwand; leispil afscherming; voetbediende noodstop rem

Order nr.	713461168	713461169
Algemeen		
Orig. nr.	D420X1000DPA	D420X1500DPA
Elektrische aansluiting		
Spanning	V	3x400
Vermogen motor	kW	4,5
Vermogen motor koelpomp	W	100
Capaciteit		
Centerhoogte	mm	210
Centerafstand	mm	1000
Draaidiameter boven bed	mm	420
Draaidiameter boven slede	mm	250
Draaidiameter zonder bedbrug	mm	590
Draailengte in de bedbrug	mm	260
Bedbreedte	mm	250
Kop		
Aantal snelheden		16
Spindeltoerental	min-1	45-1800
Spilkonus	MK	6
Spilneus Camlock DIN55029		D1-6"
Spilboring	mm	52
Draadstappen en voeding		
Langsvoeding	mm/O	0,05-1,7 (17)
Dwarsvoeding	mm/O	0,025-0,85 (17)
Draadsnijden metrisch	M	0,2-14 (39)
Draadsnijden duim	Gg/1"	722 (45)
Trapeziumdraad	D.P.	8-44 (21)
Modulaire draad	M.P.	0,3-3,5 (18)
Geleiding en wagen		
Rijweg beitelplede	mm	140
Rijweg dwarsplede	mm	230
Hoogte beitelhouder	mm	20
Losse kop		
Konus losse kop	MK	4
Koers losse kop	mm	120
Gewicht	kg	1550,00
Afmetingen (l x b x h)	mm	2025 x 915 x 1615
Prijs	€	10.690,00
		11.995,00

D420x1000 DPA/D420x1500 DPA

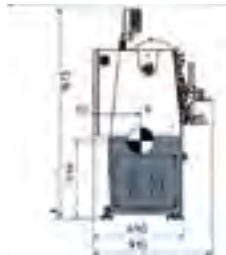
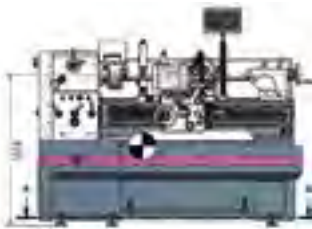
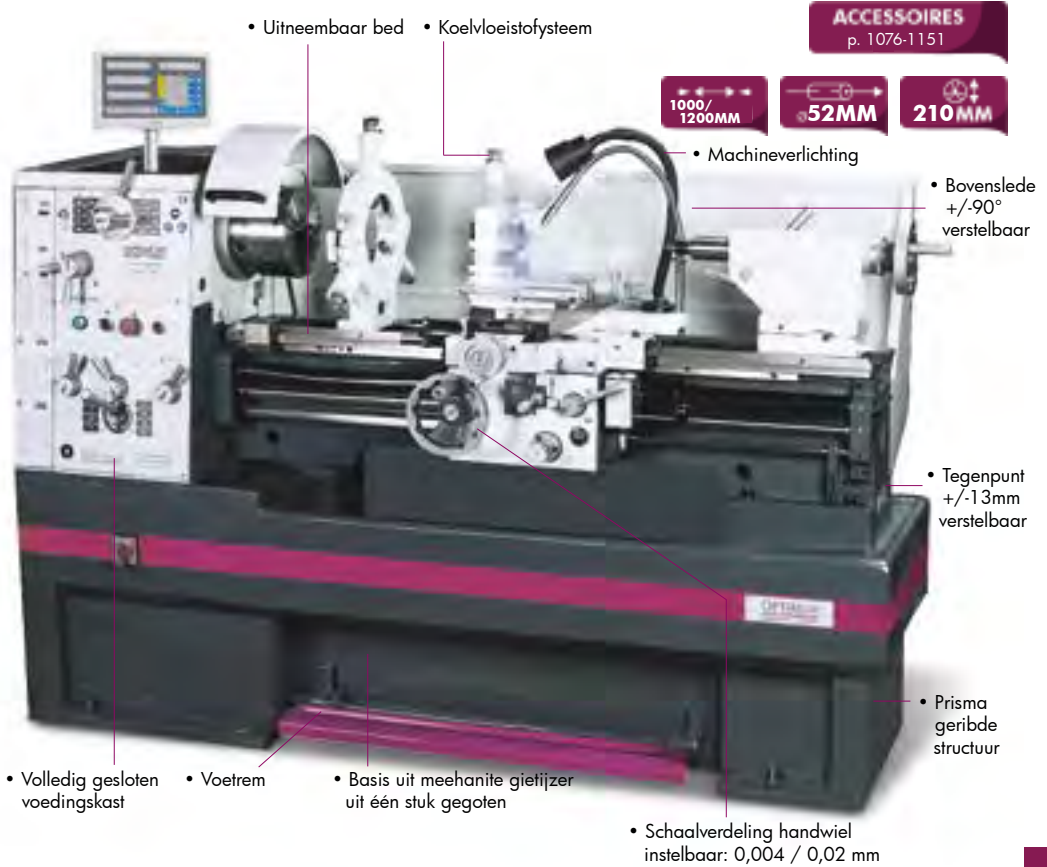
**Standaard geleverd met:**

- Zelfcenterende klauwplaat met 3 klauwen \varnothing 200 mm rechtstreekse koppeling directe montage (zonder gebruik van flens)
- Onafhankelijke vierbekken plaat \varnothing 250 mm rechtstreekse koppeling directe montage (zonder gebruik van flens)
- Vlakplaat \varnothing 350 mm
- Reductiehuls MK6-MK4
- 2 Vaste centers MK4
- Vaste bril met doorlaat van maximum 145 mm
- Volg bril met doorlaat van maximum 75 mm
- Draadsnijlok
- Wisselwielen set
- Bedieningsleutels
- Afnameprotocol
- Nederlandstalige handleiding, opschriften, CE - kenmerk, en CE-attest volgens Machine richtlijn 2006/42/CE, Laagspanningsrichtlijn 2006/95/CE en EMC Richtlijn 2004/108/CE.

Tip: wordt geleverd zonder tandwielolie 790030020 (10 liter nodig) vergeet deze niet bij te bestellen. Installatie, ingebruikname en scholing door gekwalificeerde technici op aanvraag



Compleet uitgeruste, zware lei- en voedingsas draaibank.

Troeven:

- Uit één stuk gegoten Meehaniet gietijzeren machineonderstel
- Uiterst krachtige, onderhoudsvrije motor van 5,5 kW
- Gesloten koelvloeistofsysteem met koelpomp
- Uitneembaar bedbrug voor het draaien van grotere diameters
- Halogeen machineverlichting
- Met digitale uitlezing DPA2000 op 3 assen gemonteerd
- Snelwisselende beitelhoeder SWH5 – B met 1 vierkantshouder

Geslacht voor:

- Vlakdraaien, langs- en dwarsdraaien, afsteken, kegeldraaien en draadsnijden
- Algemeen onderhoud, opleidingcentra en scholen

Kenmerken:

- Camlock spilneus ASA D1-6" volgens DIN55029
- Alle geleidingen door spieën na stelbaar
- In een oliebad lopende hoofdspindel, gehard en geslepen met twee afstelbare precisie kogellagers. Geharde en geslepen tandwielen en assen, precisielopend in een oliebad
- Keuzeschakelaar rechts – linksdraaiend
- Sterk geribd prismabed van gietstaal (GG30), inductie gehard en fijn geslepen
- Losse kop kan +- 13 mm verschoven worden voor het draaien van kegels

Veiligheden:

- Aparte noodstop, aparte start en stopknop
- Nullastspanning; lage voltage 24V bedieningsknopen
- Microschakelaars in tandwielkast en klauwplaatafscherming
- Spatwand; leispil afscherming; voetbediende noodstop rem

Order nr.	713402159	713402209
Algemeen		
Orig. nr.	D460X1500 DPA SWH	D460X2000 DPA SWH
Elektrische aansluiting		
Spanning	V	3x400
Vermogen motor	kW	5,8
Vermogen motor koelpomp	W	100
Capaciteit		
Centerhoogte	mm	230
Centerafstand	mm	1500
Draaidiameter boven bed	mm	465
Draaidiameter boven slede	mm	270
Draaidiameter zonder bedbrug	mm	690
Draailengte in de bedbrug	mm	240
Bedbreedte	mm	300
Kop		
Aantal snelheden		12
Spindeltoerental	min-1	25-2000
Spilkonus	MK	6
Spilneus Camlock DIN55029		D1-6"
Spilboring	mm	58
Draadstappen en voeding		
Langsvoeding	mm/O	0,031-1,7 (42)
Dwarsvoeding	mm/O	0,014-0,784 (42)
Draadsnijden metrisch	M	0,1-14 (53)
Draadsnijden duim	Gg/1"	1122 (40)
Trapeziumdraad	D.P.	4-112 (50)
Modulaire draad	M.P.	0,1-7 (34)
Geleiding en wagen		
Rijweg beitelslede	mm	128
Rijweg dwarslede	mm	285
Hoogte beitelhoeder	mm	25
Losse kop		
Konus losse kop	MK	4
Koers losse kop	mm	130
Gewicht	kg	1977,00
Afmetingen (l x b x h)	mm	2750 x 1245 x 1568
Prijs	€	14.995,00
		16.470,00

D460x1500 DPA/D460x2000 DPA

- Afzonderlijke koelbak



- SWH 40 posities snelwissel beitelhoeder

- Draadsnijblok

- Koelvloeistofsysteem met koelpomp & tank

ACCESSOIRES
p. 1076-1151

1500/
2000MM

58MM

220MM

- 12 snelheden van 25/2000 tpm

- Camlock spindel

- DPA digitale aflezing op 3 assen

- Tegenpunt MK4 spil

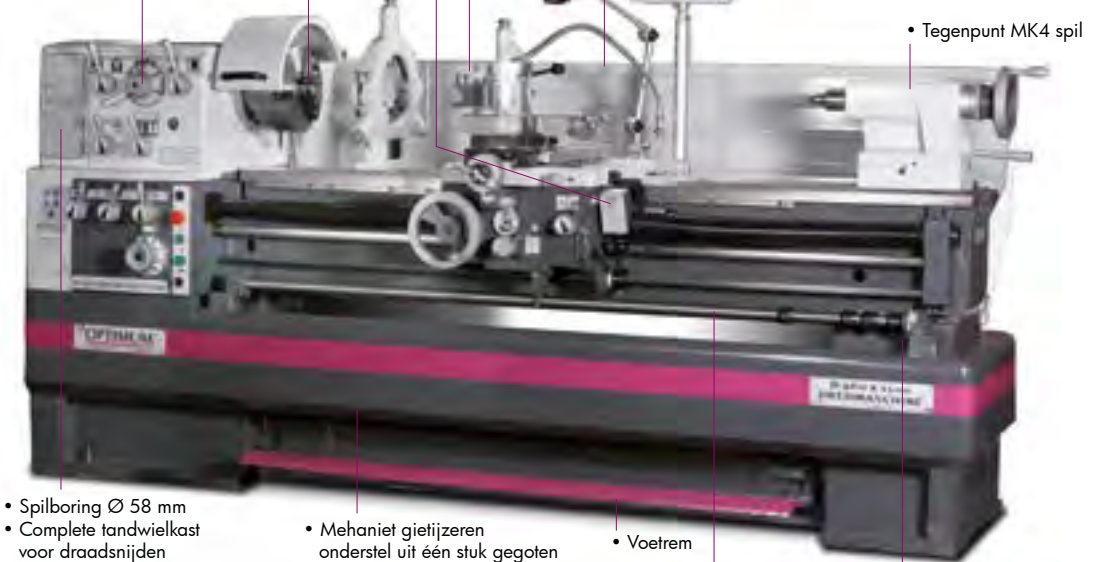

- Spilboring \varnothing 58 mm
- Complete tandwielkast voor draadsnijden

- Mechaniek gietijzeren onderstel uit één stuk gegoten

- Voetrem

- Keuzehendel links/rechts draaien

- 4 positie lengte aanslag

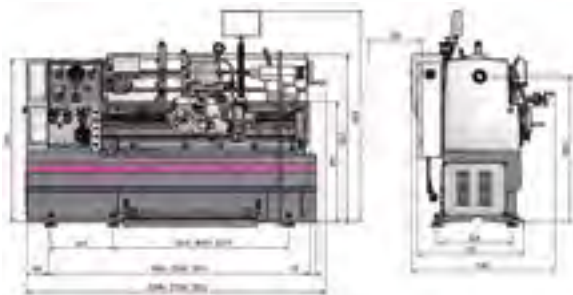

Standaard geleverd met:

- Zelfcenterende klauwplaat met 3 klauwen \varnothing 250 mm rechtstreekse koppeling directe montage (zonder gebruik van flens)
- Onafhankelijke vierbekken plaat \varnothing 300 mm rechtstreekse koppeling directe montage (zonder gebruik van flens)
- Vlakplaat \varnothing 350 mm
- Reductiehuls MK6-MK4
- 2 Vaste centers MK4
- Vaste bril met doorlaat van maximum 160 mm
- Volg bril met doorlaat van maximum 100 mm
- Draadsnijblok
- Wisselwielen set
- Bedieningsleutels
- Afnameprotocol
- Nederlandstalige handleiding, opschriften, CE - kenmerk, en CE-attest volgens Machine richtlijn 2006/42/CE, Laagspanningsrichtlijn 2006/95/CE en EMC Richtlijn 2004/108/CE.

Tip: wordt geleverd zonder tandwielolie 790030020 (20 liter nodig), vergeet deze niet bij te bestellen. Installatie, ingebruikname en scholing door gekwalificeerde technici op aanvraag

Compleet uitgeruste, zware lei- en voedingsas draaibank, met veelvuldige schijfkoppeling en grote doorlaat ø105 mm.

Troeven:

- Hoogwaardig gietijzeren onderstel
- Mechanische veelvuldige koppeling voor het kiezen van draairichting zonder de motor te laten afslaan.
- Uiterst krachtige, onderhoudsvrije motor van 7,5 kW
- Grote doorlaat van 105 mm
- Gesloten koelvloeistofsysteem met koelpomp
- Met digitale uitlezing op 3 assen gemonteerd
- 40 positie snelwissel beitelhouder SWH9-D met 1 vierkante beitelhouder

Geschikt voor:

- Vlakdraaien, langs- en dwarsdraaien, afsteken, kegeldraaien en draadsnijden
- Algemeen onderhoud, opleidingcentra en scholen, herstel van landbouwmachines

Kenmerken:

- Spindelopname Camlock DIN ISO 7022 Nr. 8
- Gegarandeerde rondloopnauwkeurigheid van de spilneus beter dan 0,015 mm
- Sterk geribd prismabed uit grijsgietijzer, inductie gehard en precisie geslepen
- Geharde spilneus en gelagerd in na stelbare kegelkogellagers klasse P5 kwaliteit.
- Tandwielen en assen zijn gehard en geslepen, lopend in een oliebad met precisie lagere
- Rechts / links lopend door middel van hendel aan de wagen
- Centraal smeersysteem voor het bed
- De elektrische routing loopt in een kabelgoot, dus geen loshangende kabels in de koelvloeistof, alsook een mooie geleidingen van de elektrische kabels van de wagen
- Elektrische componenten van Siemens of Schneider
- Alle geleidingen door spieën nastelbaar
- Losse kop kan +- 13 mm verplaatst worden voor het draaien van kegels, met snelklemming van de losse kop voor een nog betere klemming
- Met digitale uitlezing DPA2000 op 3 assen gemonteerd

Order nr.	713462720	713462730
Algemeen		
Orig. nr.	D660X2000DPA	D660X3000DPA
Elektrische aansluiting		
Spanning	V 3x400	3x400
Vermogen motor	kW 7,5	7,5
Vermogen motor koelpomp	W 100	100
Capaciteit		
Centerhoogte	mm 330	330
Centerafstand	mm 2000	3000
Draaidiameter boven bed	mm 660	660
Draaidiameter boven slede	mm 440	440
Draaidiameter zonder bedbrug	mm 900	900
Draailengte in de bedbrug	mm 250	250
Bedbreedte	mm 400	400
Kop		
Aantal snelheden	16	16
Spindeltoerental	min-1 25-1600	25-1600
Spilkonus	MK 7	7
Spilneus Camlock DIN55029	D1-8"	D1-8"
Spilboring	mm 105	105
Draadstappen en voeding		
Langsvoeding	mm/O 0,044-1,48 (25)	0,044-1,48 (25)
Dwarsvoeding	mm/O 0,022-0,74 (25)	0,022-0,74 (25)
Draadsnijden metrisch	M 0,45-120 (54)	0,45-120 (54)
Draadsnijden duim	Gg/1" 80-7/16 (60)	80-7/16 (60)
Trapeziumdraad	D.P. 7/8-160 (42)	7/8-160 (42)
Modulaire draad	M.P. 0,25-60 (46)	0,25-60 (46)
Geleiding en wagen		
Rijweg beitel slede	mm 230	230
Rijweg dwars slede	mm 368	368
Hoogte beitelhouder	mm 32	32
Losse kop		
Konus losse kop	MK 5	5
Koers losse kop	mm 235	235
Gewicht	kg 3345,00	3710,00
Afmetingen (l x b x h)	mm 3650 x 1230 x 1595	4650 x 1230 x 1595
Prijs	€ 26.390,00	29.490,00

D660x2000 DPA/D660x3000 DPA

ACCESSOIRES
 p. 1076-1151

 2000/
3000MM

 105MM
330MM

 105MM
330MM

- Afzonderlijke koelbak



- Klauwplaatscherming met microscharelaar

- Elektrische motorrem

- Machineverlichting

- DPA digitale aflezing op 3 assen gemonteerd

- Tegenpunt met 2 snelheden

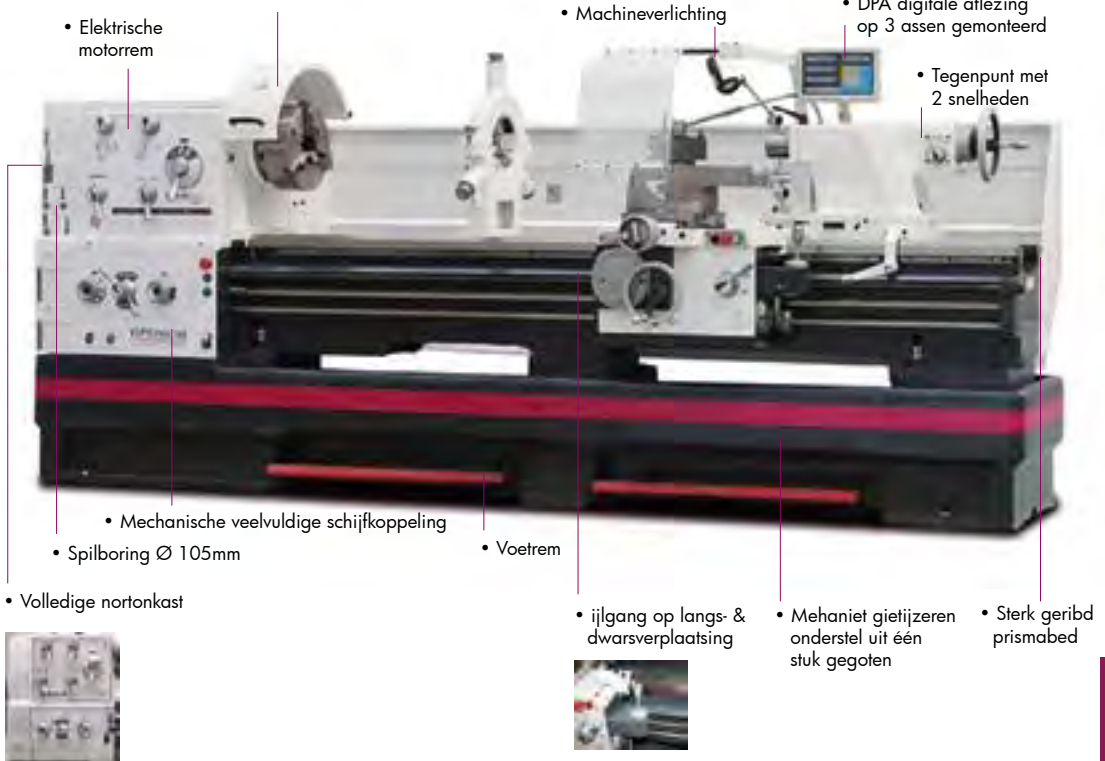

- Mechanische veelvuldige schijfkoppeling

- Spilboring Ø 105mm

- Voetrem

- Volledige nortonkast



- Ijlgang op langs- & dwarsverplaatsing

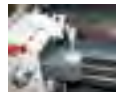

- Mehanië gietijzeren onderstel uit één stuk gegoten

- Sterk geribbd prismabed

MACHINES

Veiligheden:

- Aparte noodstop, aparte start en stopknop
- Nullastspanning, lage voltage 24V bedieningsknoppen
- Microscharelaars in tandwielkast en klauwplaatafscherming
- Spatwand en spanenbak; grote beitelfafscherming; leispil afscherming; voetbediende noodstop rem

Standaard geleverd met:

- Zelfcenterende klauwplaat met 3 klauwen ø 325 mm rechtstreekse koppeling directe montage (zonder gebruik van flens)
- Onafhankelijke vierbekken plaat ø 400 mm rechtstreekse koppeling directe montage (zonder gebruik van flens)
- Vlakplaat ø 450 mm
- Reductiehuls MK7 - MK5
- 2 Vaste centers MK5
- Vaste bril doorlaat max 150 mm
- Volg bril doorlaat van max 80 mm
- Draadsnijlklok
- Wisselwielen set
- Bedieningsleutels
- Afnameprotocol
- Nederlandstalige handleiding, opschriften, CE - kenmerk, en CE-attest volgens Machine richtlijn 2006/42/CE, Laagspanningsrichtlijn 2006/95/CE en EMC Richtlijn 2004/108/CE

Tip: wordt geleverd zonder tandwielolie 790030020 (20 liter nodig), vergeet deze niet bij te bestellen. Installatie, ingebruikname en scholing door gekwalificeerde technici op aanvraag.

Compleet uitgeruste, zware lei- en voedingsas draaibank, met veelvuldige schijfkoppeling en grote doorlaat $\varnothing 105$ mm.

Troeven:

- Hoogwaardig gietijzeren onderstel
- Mechanische veelvuldige koppeling voor het kiezen van draairichting zonder de motor te laten afslaan.
- Uiterst krachtige, onderhoudsvrije motor van 7,5 kW
- Grote doorlaat van 105 mm
- Gesloten koelvloestofstelsysteem met koelpomp
- Met digitale uitlezing op 3 assen gemonteerd
- 40 positie snelwissel beitelhoeder SWH9-D met 1 vierkante beitelhoeder

Geschied voor:

- Vlakdraaien, langs- en dwarsdraaien, afsteken, kegeldraaien en draadsnijden
- Algemeen onderhoud, opleidingscentra en scholen, herstel van landbouwmachines

Kenmerken:

- Spindelopname Camlock DIN ISO 702-2 Nr. 8
- Gegarandeerde rondloopnauwkeurigheid van de spilneus beter dan 0,015 mm
- Sterk geribd prismabed uit grijsgietijzer, inductie gehard en precisie geslepen
- Geharde spilneus en gelagerd in na stelbare kegeltogellagers klasse P5 kwaliteit.
- Tandwielen en assen zijn gehard en geslepen, lopend in een oliebad met precisie lagers
- Rechts / links lopend door middel van hendel aan de wagen
- Centraal smeersysteem voor het bed
- De elektrische routing loopt in een kabelgoot, dus geen loshangende kabels in de koelvloestof, alsook een mooie geleidingen van de elektrische kabels van de wagen.
- Elektrische componenten van Siemens of Schneider
- Alle geleidingen door spieën na stelbaar
- Losse kop kan +/- 13 mm verplaatst worden voor het draaien van kegels, met snelklemming van de losse kop voor een nog betere klemming
- Met digitale uitlezing DPA2000 op 3 assen gemonteerd

Order nr.	713462782	713462783
Algemeen		
Orig. nr.	TU8020	TU8030
Elektrische aansluiting		
Spanning	V 3x400	3x400
Vermogen motor	kW 7,5	7,5
Vermogen motor koelpomp	W 100	100
Capaciteit		
Centerhoogte	mm 400	400
Centerafstand	mm 2000	3000
Draaidiameter boven bed	mm 800	800
Draaidiameter boven slede	mm 570	570
Draaidiameter zonder bedbrug	mm 1035	1035
Draailengte in de bedbrug	mm 250	250
Bedbreedte	mm 400	400
Kop		
Aantal snelheden	16	16
Spindeltoerental	min-1 25 - 1600	25 - 1600
Spilkonus	MK 7	7
Spilneus Camlock DIN55029	D1-8" 11-8"	D1-8"
Spilboring	mm 105	105
Draadstappen en voeding		
Langsvoeding	mm/O 0,044-1,48 (25)	0,044-1,48 (25)
Dwarsvoeding	mm/O 0,022-0,74 (25)	0,022-0,74 (25)
Draadsnijden metrisch	M 0,45-120 (54)	0,45-120 (54)
Draadsnijden duim	Gg/1" 80-7/16 (60)	80-7/16 (54)
Trapeziumdraad	D.P. 7/8-160 (42)	7/8-160 (42)
Modulaire draad	M.P. 0,25-60 (46)	0,25-60 (46)
Geleiding en wagen		
Rijweg beitelslede	mm 230	230
Rijweg dwarslede	mm 420	368
Hoogte beitelhoeder	mm 32	32
Losse kop		
Konus losse kop	MK 5	5
Koers losse kop	mm 235	235
Gewicht	kg 3505,00	3710,00
Afmetingen (l x b x h)	mm 3740 x 1230 x 1595	4707 x 1230 x 1595
Prijs	€ 28.190,00	31.390,00

TU8020/TU8030

- Afzonderlijke koelbak



- SWH 40 posities snelwissel beitelhoeder

ACCESSOIRES
p. 1076-1151

2000/
3000MM

Ø105MM

400MM

- Klauwplaat scherming met microscharrelaar

- Elektrische motorrem

- Machineverlichting

- DPA digitale aflezing op 3 assen gemonteerd



- Spilboring Ø 105mm

- Mechanische veelvuldige schijfkoppeling

- Voetrem

- Sterk geribd prismabed

- Volledige nortonkast

- Kabels in kabelgoot

- iJlgang op langs- & dwarsverplaatsing

- Tegenpunt met 2 snelheden



- Mechaniet gietijzeren onderstel uit één stuk gegoten

Veiligheden:

- Aparte noodstop, aparte start en stopknop
- Nullastspanning; lage voltage 24V bedieningsknopen
- Microscharrelaars in tandwielkast en klauwplaat afscherming
- Spatwand en spanenbak; grote beitelaafscherming; leispil afscherming
- Voetbediende noodstop rem

Standaard geleverd met:

- Zelfcenterende klauwplaat met 3 klauwen ø 325 mm rechtstreekse koppeling directe montage (zonder gebruik van flens)
- Onafhankelijke vierbekken plaat ø 400 mm rechtstreekse koppeling directe montage (zonder gebruik van flens)
- Vlakplaat ø 450 mm Reductiehuls MK7 - MK5
- 2 Vaste centers MK5
- Vaste bril doorlaat max 150 mm
- Volg bril doorlaat van max 80 mm
- Draadsnijklak
- Wisselwielen set
- Bedieningsleutels
- Afnameprotocol
- Nederlandstalige handleiding, opschriften, CE - kenmerk, en CE-attest volgens Machine richtlijn 2006/42/CE, Laagspanningsrichtlijn 2006/95/CE en EMC Richtlijn 2004/108/CE

Tip: wordt geleverd zonder tandwielolie 790030020 (20 liter nodig), vergeet deze niet bij te bestellen. Installatie, ingebruikname en scholing door gekwalificeerde technici op aanvraag.

CNC freesmachines



Stabiele CNC machinecenter met nieuwe Siemens sturing 808D.

Troeven:

- Lineaire geleidingen op alle assen
- Elektro-pneumatisch gestuurd gereedschapsaantrekker, BT30
- Centraal automatisch smeersysteem
- Draagbare afstandsbediening (MPG)

Geschikt voor:

- Scholen / opleidingscentra, RenD afdeling
- Vlug, eenvoudig en nauwkeurig produceren van unieke stukken, alsook kleine series.

Kenmerken:

- Alle assen zijn voorzien van kwaliteit kogelomloopspindels
- Solide, precieze kruistafel, groot gedimensioneerd en precisie bewerkte oppervlakte voorzien van 3 T-gleuven
- Sterk, geribde machinebasis
- Centraal automatisch smeersysteem van de geleidingen, verlengt de levensduur van de machine en reduceert service
- Krachtige servomotoren in alle assen.- Verdraaibaar bedieningspaneel
- Siemens Sinumerik 808D op PC gratis verkrijgbaar (Computer werkstation)
- Siemens 808D in het Engels - Inclusief twee jaar Siemens garantie
- Metalen balbescherming van de assen tegen spaanders en koelmiddel
- Compacte, beveiligde behuizing. Kantelbaar display
- Draagbare afstandsbediening (MPG) met verlengsnoer voor de tafel, ideaal voor een snelle nulpuntbepaling
- Dubbelzijdige voet, die vooraan ruimte biedt voor opbergruimte, achteraan voor het elektronisch systeem, spanen opvangbak, alsook het koelvloeistofsysteem
- Gesloten koelvloeistofsysteem met koelpomp. Tankinhoud 50 liter
- Siemens sturing voorzien van USB en RS232 aansluiting

Veiligheden:

- Voordeur uitgerust met veiligheidsschakelaar
- Helder verlichte werkomgeving door geïntegreerde LED machineverlichting
- De werkruimte is goed zichtbaar vanaf drie zijden, afgeschermd door transparante, duurzame en uiterst grote Macrolon panelen
- Overzichtelijke elektrische kast, met genummerde bedrading
- Status indicatielamp
- Noodstop op sturing en noodstop op MPG
- Vergrendelbare hoofdschakelaar

Order nr.		713500410
Orig. nr.		F3 CNC
Spanning	V	3x400
Totaal verbruik	kW	2,5
Aandrijfmotor	kW	1,5
Torsieaandrijfmotor	Nm	10
Koelvloeistofmotor	kW	0,095
Luchtdrukaansluiting	bar	min. 8
Spilneus		BT30
Freeskop maximum afmetingen	mm	40
Maximum schachtopname frezen	mm	25
Herhaalnauwkeurigheid	mm	+/-0,015
Positioneernauwkeurigheid	mm	+/-0,015
X-as (1)	mm	355
Y-as (1)	mm	190
Z-as (1)	mm	245
Ijlgang X, Y, Z-as	mm/min	10000
Snelheden (2)	tpm	200 - 4000
Afstand spil-tafel	mm	20 - 305
Tafel lengte x breedte	mm	620 x 180
Maximum belastbaar gewicht	kg	30
Tankinhoud	l	50
T-gleuven grootte/aantal/afstand	mm	12/3/50
Gewicht	kg	1400,00
Afmetingen (l x b x h)	mm	1600 x 1530 x 2010

F3 CNC

BT30



F3 CNC

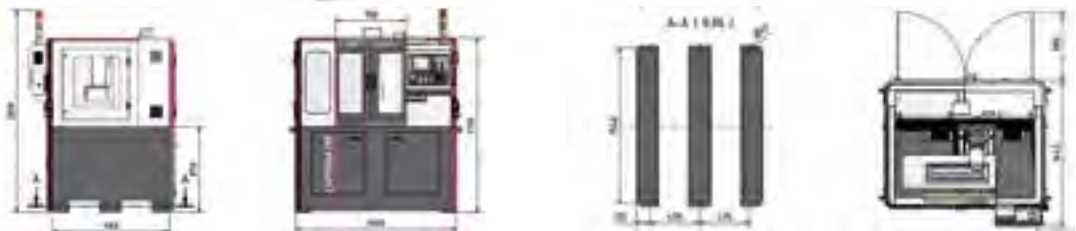

MACHINES

Uitmuntende prestatie. Gewoonweg eenvoudig. SIEMENS SINUMERIK 808 D:

- Eenvoudige, intuïtieve gebruikersinterface
- Sinumerik gebruikersinterface Basic met Sinumerik startgids voor een nieuwe dialoog gebaseerde gebruikersondersteuning, die u doorheen de machine instellingen zal loodsen en reduceert de insteltijd tot een minimum
- 7,5" kleuren LCD scherm
- 80-bits nano nauwkeurigheid aandrijvingen
- Sinumerik MDynamics (cyclus 832)
- DIN / ISO programmeren
- Contourberekening
- Online Help
- Max. 3 interpolerende assen
- Geheugen grootte 1,25 MB (uitbreidbaar via USB)
- 50 instelling vooruitziend
- Metrisch / inch omschakelen
- Program GUIDE BASIC

Leveringsomvang:

- Datakabel RS 232
- Bedieningsgereedschap
- Nederlandstalige handleiding, opschriften, CE - kenmerk, en CE-attest volgens Machine richtlijn 2006/42/CE, Laagspanningsrichtlijn 2006/95/CE en EMC Richtlijn 2004/108/CE

Tip: Installatie, ingebruikname en scholing door gekwalificeerde technici op aanvraag.

Stabiele CNC machinecenter met nieuwe Siemens sturing 808D.

Troeven:

- Lineaire geleidingen op alle assen
- Automatisch, pneumatisch gereedschapmagazijn voor 8 gereedschappen, BT30.
- Centraal automatisch smeersysteem
- Draagbare afstandsbediening (MPG)

Geschikt voor:

- Scholen / opleidingscentra, RenD afdeling
- Vlug, eenvoudig en nauwkeurig produceren van unieke stukken, alsook kleine series.

Kenmerken:

- Alle assen zijn voorzien van kwaliteit kogelomloopspindels
- Solide, precieze kruistafel, groot gedimensioneerd en precisie bewerkte oppervlakte voorzien van 3 T-gleuven
- Sterk, geribde machinebasis
- Centraal automatisch smeersysteem van de geleidingen, verlengt de levensduur van de machine en reduceert service.
- Krachtige servomotoren in alle assen.- Verdraaibaar bedieningspaneel
- Siemens Sinumerik 808D op PC gratis verkrijgbaar (Computer werkstation)
- Siemens 808D in het Engels - Inclusief twee jaar Siemens garantie
- Metalen balbescherming van de assen tegen spaanders en koelmiddel.
- Compacte, beveiligde behuizing. Kantelbaar display.
- Draagbare afstandsbediening (MPG) met verlengsnoer voor de tafel, ideaal voor een snelle nulpuntbepaling. Voorzien van een noodstop.
- Dubbelzijdige voet, die vooraan ruimte biedt voor opbergruimte, achteraan voor het elektronisch systeem, spanen opvangbak, alsook het koelvloeistofsysteem
- Gesloten koelvloeistofsysteem met koelpomp. Tankinhoud 50 liter.
- Siemens sturing voorzien van USB en RS232 aansluiting

Veiligheden:

- Voordeur uitgerust met veiligheidsschakelaar.
- Helder verlichte werkomgeving door geïntegreerde LED machineverlichting
- De werkruimte is goed zichtbaar vanaf drie zijden, afgeschermd door transparante, duurzame en uiterst grote Macrolon panelen.
- Status indicatielamp
- Noodstop op sturing en noodstop op MPG
- Vergrendelbare hoofdschakelaar

Order nr.	713500430	
Orig. nr.		F4 CNC
Spanning	V	3x400
Totaal verbruik	kW	8,5
Aandrijfmotor	kW	2,2
Torsieaandrijfmotor	Nm	14
Koelvloeistofmotor	kW	0,095
Luchtdrukaansluiting	bar	Min 7
Spilneus		BT30
Freeskop maximum afmetingen	mm	65
Maximum schachtopname frezen	mm	30
Herhaalnauwkeurigheid	mm	+/- 0,015
Positioneernauwkeurigheid	mm	+/- 0,015
Aantal gereedschappen		8
Type		discus
Maximum gereedschapsdiameter	mm	70
Maximum gereedschapsgewicht	kg	6
Wisseltijd - tool-to-tool	sec	8
X-as (1)	mm	310
Y-as (1)	mm	200
Z-as (1)	mm	300
X-as servomotor koppel	Nm	3,3
Y-as servomotor koppel	Nm	5
Z-as servomotor koppel	Nm	5
Ijlgang X, Y, Z-as	mm/min	10000
Snelheden (2)	tpm	50 - 9.000
Afstand spil-tafel	mm	90 - 390
Tafel lengte x breedte	mm	690x210
T-gleuven grootte/aantal/afstand		16/3/63
Maximum belastbaar gewicht	kg	100
Tankinhoud	l	50
T-gleuven grootte/aantal/afstand	mm	16/3/63
Gewicht	kg	1800,00
Afmetingen (l x b x h)	mm	1800 x 1720 x 2000

F4 CNC

BT30

1000KG



- Gereedschapssysteem:
 - Automatisch d.m.v. magazijn voor 8 gereedschappen
 - Max. gereedschapsdiameter 50 mm



- Elektrische kast:
 - Overzichtelijke structuur
 - Groot gedimensioneerd

- 50-9000 tpm
BT30 spindel

- Siemens 808D



F4 CNC



- Centraal smeersysteem:
Vermindert slijtage en verhoogt de levensduur van uw machine

VERPL.
X: 310MM
Y: 200MM
Z: 300MM



MACHINES

Uitmuntende prestatie. Gewoonweg eenvoudig. SIEMENS SINUMERIK 808 D:

- Eenvoudige, intuïtieve gebruikersinterface.
- Sinumerik gebruikersinterface Basic met Sinumerik startgids voor een nieuwe dialoog gebaseerde gebruikersondersteuning, die doorheen de machine instellingen zal loodsen en reduceert de insteltijd tot een minimum.
 - 7,5" kleuren LCD scherm
 - 80-bits nano nauwkeurigheid aandrijvingen
 - Sinumerik MDynamics (cyclus 832)
 - DIN / ISO programmeren
 - Contourberekening
 - Online Help
 - Max. 3 interpolerende assen
 - Geheugen grootte 1,25 MB (uitbreidbaar via USB)
 - 50 instelling vooruitziend
 - Metrisch / inch omschakelen
 - Program GUIDE BASIC

Leveringsomvang:

- Datakabel RS 232
- Bedieningsgereedschap
- Nederlandstalige handleiding, opschriften, CE - kenmerk, en CE-attest volgens Machine richtlijn 2006/42/CE, Laagspanningsrichtlijn 2006/95/CE en EMC Richtlijn 2004/108/CE

Tip: Installatie, ingebruikname en scholing door gekwalificeerde technici op aanvraag

Degelijke, compacte oplossing van een CNC machinecenter met nieuwe Siemens sturing 808D.

Troeven:

- Lineaire geleidingen op alle assen
- Spindelmotor met 8.000 min⁻¹ als standaard
- Automatisch, pneumatisch gereedschapmagazijn voor 10 gereedschappen, BT30.
- Centraal automatisch smeersysteem
- Draagbare afstandsbediening (MPG)

Geschikt voor:

- Scholen / opleidingscentra, RenD afdeling
- Vlug, eenvoudig en nauwkeurig produceren van unieke stukken, alsook kleine series.

Kenmerken:

- Alle assen zijn voorzien van kwaliteit kogelomloopspindels
- Solide, precieze kruistafel, groot gedimensioneerd en precisie bewerkte oppervlakte voorzien van 5 T-gleuven
- Sterk, geribde machinebasis
- Centraal automatisch smeersysteem van de geleidingen, verlengt de levensduur van de machine en reduceert service.
- Krachtige servomotoren in alle assen.
- Siemens Sinumerik 808D op PC gratis verkrijgbaar (Computer werkstation)
- Siemens 808D in het Engels - Inclusief twee jaar Siemens garantie
- Metalen balgbescherming van de assen tegen spaanders en koelmiddel.
- Compacte, beveiligde behuizing. Kantelbare display.
- Draagbare afstandsbediening (MPG) met verlengsnoer voor de tafel, ideaal voor een snelle nulpuntbepaling. Voorzien van een noodstop.
- Gesloten koelvloestofsysteem met koelpomp. Tankinhoud 160 liter.
- Balanceer kettingsysteem om de vibraties van de freeskop tot een minimum te herleiden.
- Siemens sturing voorzien van USB en RS232 aansluiting

Veiligheden:

- Voordeur uitgerust met veiligheidsschakelaar.
- Helder verlichte werkomgeving door geïntegreerde LED machineverlichting
- De werkruimte is goed zichtbaar vanaf drie zijden, afgeschermd door transparante, duurzame en uiterst grote Macrolon panelen.
- Status indicatielamp
- Noodstop op sturing en noodstop op MPG
- Vergrendelbare hoofdschakelaar

Order nr.		713501080
Orig. nr.		F80 CNC
Spanning	V	3x400
Totaal verbruik	kW	9,5
Aandrijfmotor	kW	2,2
Torsieaandrijfmotor	Nm	14
Koelvloestofmotor	kW	0,65
Spilneus		ISO30 / BT30
Freeskop maximum afmetingen	mm	65
Maximum schachtopname frezen	mm	30
Herhaalnauwkeurigheid	mm	+/- 0.015
Positioneernauwkeurigheid	mm	+/- 0.015
Aantal gereedschappen		10
Type		discus
Maximum gereedschapdiameter	mm	104
Maximum gereedschapsgewicht	kg	6
X-as (1)	mm	400
Y-as (1)	mm	225
Z-as (1)	mm	375
X-as servomotor koppel	Nm	5
Y-as servomotor koppel	Nm	5
Z-as servomotor koppel	Nm	6
Ijlgang X, Y, Z-as	mm/min	10000
Snelheden (2)	tpm	50-8000
Afstand spil-tafel	mm	70-475
Tafel lengte x breedte	mm	800x260
Maximum belastbaar gewicht	kg	150
T-gleuven grootte/aantal/afstand	mm	16/5/50
Wisseltijd tool-to-tool	s	7
Inhoud koeltank	l	160
Gewicht	kg	1900,00
Afmetingen (l x b x h)	mm	1925 x 1600 x 2070

F80 CNC



- 10 gereedschapssysteem



- Overzichtelijke elektrische kast

- 50-8000 tpm BT30 spindel



- Heldere werkzone verlichting

BT30

1000KG

- Siemens 808D



F80 CNC

- MPG

VERPL. 
 X: 400MM
 Y: 225MM
 Z: 375MM

Uitmuntende prestatie. Gewoonweg eenvoudig. SIEMENS SINUMERIK 808 D:

- Eenvoudige, intuïtieve gebruikersinterface.
- Sinumerik gebruikersinterface Basic met Sinumerik startgids voor een nieuwe dialoog gebaseerde gebruikersondersteuning, die u doorheen de machine instellingen zal loodsen en reduceert de insteltijd tot een minimum.
 - 7,5" kleuren LCD scherm
 - 80-bits nano nauwkeurigheid aandrijvingen
 - Sinumerik MDynamics (cyclus 832)
 - DIN / ISO programmeren
 - Contourberekening
 - Online Help
 - Max. 3 interpolerende assen
 - Geheugen grootte 1,25 MB (uitbreidbaar via USB)
 - 50 instelling vooruitziend
 - Metrisch / inch omschakelen
 - Program GUIDE BASIC

Leveringsomvang:

- Datakabel RS 232
- Gereedschapshouder
- Bedieningsgereedschap
- Nederlandstalige handleiding, opschriften, CE - kenmerk, en CE-attest volgens Machine richtlijn 2006/42/CE, Laagspanningsrichtlijn 2006/95/CE en EMC Richtlijn 2004/108/CE

Tip: Installatie, ingebruikname en scholing door gekwalificeerde technici op aanvraag

CNC gestuurde machines

OPTICAL

De compacte oplossing voor het produceren van kleine series in kleine en middel grote ondernemingen, en opleidingcentra met nieuwe Siemens sturing 808D of 808D Advanced.

Troeven:

- Lineaire geleidingen op alle assen
- Spindelmotor met 8.000 min-1 als standaard
- Automatisch, pneumatisch gereedschapmagazijn voor 12 gereedschappen, BT40.
- Centraal automatisch smeersysteem
- Draagbare afstandsbediening (MPG)
- Met 808D Advanced uitbreiding 4de as mogelijk (optie)

Geschikt voor:

- Scholen / opleidingscentra
- kleine en middel grote ondernemingen, RenD afdeling
- Vlug, eenvoudig en nauwkeurig produceren van unieke stukken, alsook kleine series.

Kenmerken:

- Alle assen zijn voorzien van kwaliteit kogelomloopspindels
- Solide, precieze kruistafel, groot gedimensioneerd en precisie bewerkte oppervlakte voorzien van 3 T-gleuven
- Sterk, geribde machinebasis
- Centraal automatisch smeersysteem van de geleidingen, verlengt de levensduur van de machine en reduceert service.
- Krachtige servomotoren in alle assen.
- Siemens Sinumerik 808D op PC gratis verkrijgbaar (Computer werkstation)
- Siemens 808D in het Engels - Inclusief twee jaar Siemens garantie
- Metalen balbescherming van de assen tegen spaanders en koelmiddel.
- Compacte, beveiligde behuizing. Kantelbare display.
- Draagbare afstandsbediening (MPG) met verlengsnoer voor de tafel, ideaal voor een snelle nulpuntbepaling. Voorzien van een noodstop.
- Gesloten koelvoelstofsysteem met koelpomp. Tankinhoud 160 liter.
- Balanceer kettingsysteem om de vibraties van de freeskop tot een minimum te herleiden.
- Siemens sturing voorzien van USB en RS232 aansluiting

Veiligheden:

- Voordeur uitgerust met veiligheidsschakelaar.
- Helder verlichte werkomgeving door geïntegreerde LED machineverlichting
- De werkruimte is goed zichtbaar vanaf drie zijden, afgeschermd door transparante, duurzame en uiterst grote Macrolon panelen.
- Status indicatielamp
- Noodstop op sturing en noodstop op MPG
- Vergrendelbare hoofdschakelaar

Order nr.	713501105 M
Orig. nr.	F105 CNC
Spanning	3x400
Totaal verbruik	10
Aandrijfmotor	5.5
Torsieaandrijfmotor	35
Koelvoelstofsysteem	0.65
Spilneus	ISO40 / BT40
Freeskop maximum afmetingen	75
Maximum schachtopname frezen	35
Herhaalnauwkeurigheid	+/- 0.01
Positioneernauwkeurigheid	+/- 0.01
Aantal gereedschappen	12
Type	discus
Maximum gereedschapsdiameter	104
Maximum gereedschapsgewicht	6
Wisseltijd - tool-to-tool	7
X-as (1)	550
Y-as (1)	305
Z-as (1)	460
X-as servomotor koppel	5
Y-as servomotor koppel	5
Z-as servomotor koppel	10
Ijlgang X, Y, Z-as	mm/min
Snelheden (2)	tpm
Afstand spil-tafel	mm
Tafel lengte x breedte	mm
T-gleuven grootte/aantal/afstand	14/3/100
Maximum belastbaar gewicht	kg
Inhoud koeltank	l
Gewicht	kg
Afmetingen (l x b x h)	mm

F105 CNC



- 12 gereedschapssysteem

- Overzichtelijke elektrische kast

- 10-8000 tpm BT40 spindel

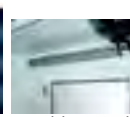

- Heldere werkzone verlichting

BT40

2800KG

- Siemens 808D



F105 CNC



- Centrale automatische smering

VERPL. 
 X: 550MM
 Y: 305MM
 Z: 460MM

- Software Advanced machine: mogelijkheid 4de as.

Uitmuntende prestatie. Gewoonweg eenvoudig. SIEMENS SINUMERIK 808 D:

- Eenvoudige, intuïtieve gebruikersinterface.
- Sinumerik gebruikersinterface Basic met Sinumerik startgids voor een nieuwe dialoog gebaseerde gebruikersondersteuning, die u doorheen de machine instellingen zal loodsen en reduceert de insteltijd tot een minimum.
 - 7,5" kleuren LCD scherm
 - 80-bits nano nauwkeurigheid aandrijvingen
 - Sinumerik MDynamics (cyclus 832)
 - DIN / ISO programmeren
 - Contourberekening
 - Online Help
 - Max. 3 interpolerende assen
 - Geheugen grootte 1,25 MB (uitbreidbaar via USB)
 - 50 instelling vooruitziend
 - Metrisch / inch omschakelen
 - Program GUIDE BASIC

SIEMENS SINUMERIK 808 D Advanced (713501100):

- Uitgeurst met de krachtige Sinamics V70 en SIMOT ICS S-1FL6 motor.
- tot 4 assen + spindel
- AST (Auto Servo Tuning)
- STO (Safe Torque Off)

Leveringsomvang:

- Datakabel RS 232
- Gereedschapshouder
- Bedieningsgereedschap
- Nederlandstalige handleiding, opschriften, CE - kenmerk, en CE-attest volgens Machine richtlijn 2006/42/CE, Laagspanningsrichtlijn 2006/95/CE en EMC Richtlijn 2004/108/CE

Tip: Installatie, ingebruikname en scholing door gekwalificeerde technici op aanvraag

CNC draaibanken

OPTI^{lum}

Stabiele CNC vlakbed draaicenter met nieuwe Siemens sturing 808D.

Troeven:

- Automatische 4-voudige gereedschapwisselaar aan de achterzijde van de wagen gemonteerd voor eenvoudig werk.
- Incrementele positie encoder van de spindel positie (voor draadsnijden)
- Centrale automatische smering
- Twee elektronische handwielen voor manueel draaien

Geschikt voor:

- Ideaal voor kleine series en opleidingcentra, en vlug produceren van unieke stukken

Kenmerken:

- Precisie afwerking
- Versterkt machinebed uit grijs gietijzer
- Inductie gehard (HRC 42-52) en precisiegeslepen
- Uitzonderlijke spindellagering
- Links- en rechts draaiend
- Eenvoudig te onderhouden behuizing, met openklapbare panelen op de achterkant voor onderhoud.
- Siemens Sinumerik 808D op PC gratis beschikbaar (computer werkstation)
- Ingebouwde koelmiddelinrichting, wegneembaar om eenvoudig spanen te verwijderen
- Machineverlichting

Order nr.	713504210 	
Algemeen		
Orig. nr.		L28HS
Vermogen		
Spanning	V	3x400
Totaal vermogen	kW	3
Vermogen spindel	kW	2,2
Vermogen motor koelpomp	W	95
Tankinhoud	l	83
Capaciteit		
Centerhoogte	mm	140
Centerafstand	mm	650
Draaidiameter boven bed	mm	300
Draaidiameter boven slede	mm	200
Bedbreedte	mm	180
Spindeltoerental	min-1	40 - 4000
Spindeltoerental	min-1	40 - 4000
Spil		
Spilboring	mm	
Spilopname		(DIN6350) A23
Spilboring	mm	
Draaimoment spindel	Nm	28
Gereedschapswisselaar		
Type		servo/pneum.
Aantal posities		4 (vierkant)/ 4 (rond)
Maximum hoogte vierkant	mm	12
Maximum diameter rond	mm	16
Nauwkeurigheid		
Herhaalnauwkeurigheid	mm	+/- 0,01
Positioneernauwkeurigheid	mm	+/- 0,03
Verplaatsingen		
X-as	mm	145
Z-as	mm	465
Voeding		
Voeding X-as	mm/min	8000
Voeding Z-as	mm/min	8000
Koppel motor X-as	Nm	1,3
Koppel motor Z-as	Nm	2,4
Losse kop		
Konus losse kop	MK	2
Spil losse kop	mm	30
Verplaatsing losse kop	mm	80
Afmetingen		
Gewicht	kg	900,00
Afmetingen (l x b x h)	mm	1655 x 1265 x 1910

L28HS



- Directe spilaandrijving



- Status indicatielamp
- Goed verlichte werkzone **NEW**



- Gereedschapswisselaar 4-weg

- Centraal smeersysteem



- Wegneembare spanenopvangbak

L28HS

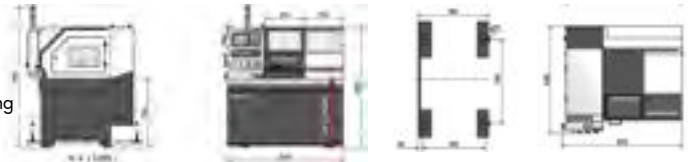

Veiligheden:

- Noodstop knop met stroomuitval beveiliging
- Veiligheidsschakelaars op alle deuren
- Status indicatielamp
- Vergrendelbare hoofdschakelaar

Uitmuntende prestatie. Gewoonweg eenvoudig. SIEMENS SINUMERIK 808 D:

- Eenvoudige, intuïtieve gebruikersinterface.
- Sinumerik gebruikersinterface Basic met Sinumerik startgids voor een nieuwe dialoog gebaseerde gebruikersondersteuning, die u doorheen de machine instellingen zal loodsen en reduceert de insteltijd tot een minimum.
 - 7,5" kleuren LCD scherm
 - 80-bits nano nauwkeurigheid aandrijvingen
 - Sinumerik MDynamics (cyclus 832)
 - DIN / ISO programmeren
 - Contourberekening
 - Online Help
 - Max. 3 interpolerende assen
 - Geheugen grootte 1,25 MB (uitbreidbaar via USB)
 - 50 instelling vooruitziend
 - Metrisch / inch omschakelen
 - Program GUIDE BASIC

Leveringsomvang:

- Bedieningsgereedschap
- Nederlandsstalige handleiding, opschriften, CE - kenmerk, en CE-attest volgens Machine richtlijn 2006/42/CE, Laagspanningsrichtlijn 2006/95/CE en EMC Richtlijn 2004/108/CE

Tip: wordt geleverd zonder klauwplaat en opnameflens, vergeet deze niet bij te bestellen. Installatie, ingebruikname en scholing door gekwalificeerde technici op aanvraag.

Stabiele CNC vlakbed draaicenter met nieuwe Siemens sturing 808D.of met Siemens 808D Advanced.

Troeven:

- Automatische 8-voudige gereedschapwisselaar aan de achterzijde van de wagen gemonteerd voor eenvoudig werk.
- Centrale automatische smering
- Incrementele positie encoder van de spindel positie (voor draadsnijden)
- Twee elektronische handwielen voor manueel draaien

Geschikt voor:

- Scholen / opleidingscentra, RenD afdeling
- Vlug, eenvoudig en nauwkeurig produceren van unieke stukken, alsook kleine series.

Kenmerken:

- Precisie afwerking
- Versterkt machinebed uit grijs gietijzer
- Inductie gehard (HRC 42-52) en precisiegeslepen
- Uitzonderlijke spindellagering
- Links- en rechts draaiend
- Eenvoudig te onderhouden behuizing, openklapbare panelen op de achterkant voor onderhoud.
- Siemens Sinumerik 808D op PC gratis beschikbaar (computer werkstation)
- Ingebouwde koelmiddelinrichting, wegneembaar om eenvoudig spanen te verwijderen
- Machineverlichting

Order nr.	713504230	713504232
Algemeen		
Orig. nr.	L34HS	L34HS ADVANCED
Vermogen		
Spanning	V	3x400
Totaal vermogen	kW	6,5
Vermogen spindel	kW	3,7
Vermogen motor koelpomp	W	95
Tankinhoud	l	100
Capaciteit		
Centerhoogte	mm	170
Centerafstand	mm	800
Draaidiameter boven bed	mm	340
Draaidiameter boven slede	mm	152
Bedbreedte	mm	208
Spindeltoerental	min-1	30-4000
Spindeltoerental	min-1	30-4000
Spil		
Spilboring	mm	
Spilopname	(DIN6350) A2-4	(DIN6350) A2-4
Spilboring	mm	
Draaimoment spindel	Nm	40
Gereedschapswisselaar		
Type	servo/pneum.	servo/pneum.
Aantal posities	8	8
Maximum hoogte vierkant	mm	16x16
Maximum diameter rond	mm	16
Nauwkeurigheid		
Herhaalnauwkeurigheid	mm	+/- 0.01
Positioneernauwkeurigheid	mm	+/- 0.025
Verplaatsingen		
X-as	mm	185
Z-as	mm	540
Voeding		
Voeding X-as	mm/min	6000
Voeding Z-as	mm/min	8000
Koppel motor X-as	Nm	4
Koppel motor Z-as	Nm	6
Losse kop		
Kanus losse kop	MK	3
Losse kop		
Spil losse kop	mm	45
Verplaatsing losse kop	mm	120
Afmetingen		
Gewicht	kg	1300,00
Afmetingen (l x b x h)	mm	1950 x 1430 x 1713

L34HS

NEW



- Automatisch gereedschapswisselaar 8 posities
- Siemens 808D of Advanced



- Grote doorlaat Ø 45 mm

- Centraal automatisch smeersysteem



L34HS



- Wegneembare spanenopvangbak

Veiligheden:

- Noodstop knop met stroomuitval beveiliging
- Veiligheidsschakelaars op alle deuren
- Status indicatielamp
- Vergrendelbare hoofdschakelaar

SIEMENS SINUMERIK 808 D:

- Eenvoudige, intuïtieve gebruikersinterface.
- Sinumerik gebruikersinterface Basic met Sinumerik startgids voor een nieuwe dialoog gebaseerde gebruikersondersteuning, die u doorheen de machine instellingen zal loodsen en reduceert de insteltijd tot een minimum.
 - 7,5" kleuren LCD scherm
 - 80-bits nano nauwkeurigheid aandrijvingen
 - Sinumerik MDynamics (cyclus 832)
 - DIN / ISO programmeren
 - Contourberekening
 - Online Help
 - Max. 3 interpolerende assen
 - Geheugen grootte 1,25 MB (uitbreidbaar via USB)
 - 50 instelling vooruitziend
 - Metrisch / inch omschakelen
 - Program GUIDE BASIC

SIEMENS SINUMERIK 808 D Advanced:

- Uitgeurst met de krachtige Sinamics V70 en SIMOT ICS S-1FL6 motor.
- tot 4 assen + spindel
- AST (Auto Servo Tuning)
- STO (Safe Torque Off)

Geleverd met::

- Bedieningsgereedschap
- Koelpomp
- Nederlandstalige handleiding, opschriften, CE - kenmerk, en CE-attest volgens Machine richtlijn 2006/42/CE, Laagspanningsrichtlijn 2006/95/CE en EMC Richtlijn 2004/108/CE

Tip: wordt geleverd zonder klauwplaat en opnameflens, vergeet deze niet bij te bestellen. Installatie, ingebruikname en scholing door gekwalificeerde technici op aanvraag.

Digitale uitlezing

OPTIMUM



Compacte digitale 3 assen positieaanduiding magneetmeetsysteem voor frees- en draaibanken met toerenweergave.

Uiterst geschikt voor:

- Al wie digitale aflezing wenst op zijn kleine conventionele frees- en draaibanken.

Troeven:

- Compact.
- Goedkoop.
- Eenvoudig meten van posities.
- Gebruiksvriendelijk menu.

Bijkomende informatie:

- Digitale weergave snelheden.
- Veelzijdige LCD display.
- 3 incrementele ingangen.
- Druktoetsen langs de voorzijde.
- Stabiele alu behuizing.

Inhoud:

- Toerentalsensor met 5 m kabel.
- 3 magneetsensoren zonder magneetband.
- Netadapter met 6 m kabel.
- Magneetplaat.

Tip: Vergeet uw magneetband niet bij te bestellen:
713383978 Magneetband lengte 1100 mm
713383979 Magneetband lengte 2000 mm

Order nr.	713383975
Orig. nr.	DRO5
Prijs	€ 675,00

OPTIMUM



Magneetband voor digitale positieaanduiding DRO 5.

Order nr.	713383978	713383979
Orig. nr.	MBL1100	MBL2000
Voor type	DRO 5	DRO 5
Lengte	mm 1100	2000
Prijs	€ 50,50	81,50

OPTIMUM



Werkplaatsmontage DRO5.

- Werkuren en klein materiaal voor het monteren van meetsysteem DRO5 in onze werkplaats op een nieuwe boorfreesmachine of kleine draaibank tot 3 assen.

Order nr.	719000420
Orig. nr.	MPU
Voor type	DRO 5
Omschrijving	montage
Prijs	€ 549,00

OPTIMUM



Digitale 3 + 1 assen positieaanduiding voor het nauwkeurige meten van de bewegingen en posities op machines en aandrijvingen.

Kenmerken:

- Gebruiksvriendelijk membraan toetsenbord, spatwaterdicht, gesloten en glansvrij
- Omschakelbaar voor freesmachine en draaibank, vrij selecteerbaar ingangssignaal (sinus/vierkant) om bijv. glaslinialen en/of magneetbandsystemen te gebruiken
- Magneetband voor montage op machines waar de ruimte onvoldoende is voor magnetische meetlatten
- Meegeleverde sensor voor de detectie van spindeltoerentallen
- Zeer hoge arbeidsnauwkeurigheid
- Aanzienlijke vermindering van de productie tijd
- Verminderde foutenpercentage
- Hoogwaardige aluminium behuizing
- Display: X, Y / Z0, Zas met 8 LED cijfers (eerste cijferteken)
- Drie meetingen met zeven correctie geheugens voor gereedschap

Beschikbare functies:

- Rekenmachine
- Weergave toerental
- Askoppeling (som Z)
- Sub D aansluitingen
- Werking in absolute/incrementele waarden
- Omschakeling metrische/duim draad
- Cirkel berekenen (incrementeel)
- Coördinaten in een cirkel (verdeelde cirkel)
- Gat in een cirkel (verdeelde cirkel)
- Omschakeling radius/diameter waarde
- Reset/voorstelling data
- Zelfdiagnose
- Referentiepunt
- Lineaire foutcorrectie
- 7 gereedschappen geheugen

Geleverd met:

- Toerental sensor
- Houder
- 24 V voeding

Tip: De meetlatten, magneetbanden en accessoires zijn optioneel verkrijgbaar.

Order nr.	713384020
Orig. nr.	DPA21
Prijs	€ 495,00

OPTIMUM

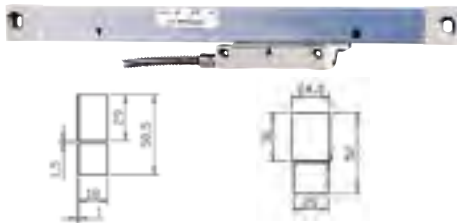

Deze glaslinialen kunnen op de meeste draaibanken, freesmachines en slijpmachines gemonteerd worden.

Troeven:

- Meetlat met hoogprecisie glazen meetstaaf.
- Nauwkeurigheid 5 µm.
- Afleeskop met miniaturkogellagers via een koppeling met de montagevoet verbonden.
- Door middel van een rubber afdichtflap beschermd tegen stof, spanen en spatwater.
- Flexibele metalen beschermingslang beschermt de 3m lange verbindingkabel (4m vanaf ML 620).
- De verbindingkabel is uitgerust met een 9 pin stekker
- Voor gebruik met DPA21/DPA22/DPA2000/DPA2000S
- Zonder montage

Voor ML 80 tot 720 mm: totale lengte is ML + 138 mm
Installatie lente is ML + 124 mm

Voor ML 720 tot 1920 mm: totale lengte is ML + 166 mm
Installatie lengte is ML + 132 mm

Geschikt voor:

- het uitrusten van draaibanken, freesmachines, slijpmachines zonder digitaal meetsysteem.
- ter vervanging van een bestaand digitaal meetsysteem op uw metaalbewerkingsmachine

Order nr.	Orig. nr.	Omschrijving	Prijs €
719000410	9000410	montage per maallat	351,00
713384108	3384108	ML 80 mm	287,00
713384110	3384110	ML 100 mm	296,00
713384112	3384112	ML 120 mm	296,00
713384117	3384117	ML 170 mm	297,00
713384122	3384122	ML 220 mm	324,00
713384127	3384127	ML 270 mm	334,00
713384132	3384132	ML 320 mm	381,00
713384137	3384137	ML 370 mm	344,00
713384142	3384142	ML 420 mm	398,00
713384147	3384147	ML 470 mm	412,00
713384152	3384152	ML 520 mm	436,00
713384157	3384157	ML 570 mm	448,00
713384162	3384162	ML 620 mm	465,00
713384167	3384167	ML 670 mm	472,00
713384172	3384172	ML 720 mm	478,00
713384177	3384177	ML 770 mm	490,00
713384182	3384182	ML 820 mm	494,00
713384187	3384187	ML 870 mm	505,00
713384192	3384192	ML 920 mm	515,00
713384197	3384197	ML 970 mm	535,00
713384202	3384202	ML 1020 mm	699,00
713384225	3384225	ML 1250 mm	945,00
713384240	3384240	ML 1400 mm	1.105,00
713384252	3384252	ML 1520 mm	1.169,00
713384267	3384267	ML 1670 mm	1.225,00
713384294	3384294	ML 1940 mm	1.399,00
713384295	3384295	ML 2110 mm	1.519,00
713384300	3384300	ML 3000 mm	2.185,00

Metten algemeen

OPTIMUM



Universeel digitaal meetsysteem.

Troeven:

- Behoudt de laatste meting in het geheugen
- Magnetisch meetsysteem
- Opklapbare aanslag
- Inclusief twee AA batterijen
- Lineaire geleiding: smeervrij, lichte loop, slijtvast, corrosiebestendig

Geschikt voor:

- Opbouw op rollenbaan MSR4H, MSR7H en MSR10H voor een perfecte langsmeting en een exacte positionering

Kenmerken:

- De afstand zaagsnit – startpunt meting kan opgeslagen worden als vast startpunt voor elke meting aan het begin van de rollenbaan
- Voor serie metingen met een hoge precisie van 0,05 mm
- Automatisch inschakelen van afleescherm
- Meetsysteem schakelt automatisch uit bij langdurig niet-gebruik en behoudt de laatste meting in het geheugen
- Meetnauwkeurigheid : +/- (0,025 +0,02 x meetlengte (m))
- Opklapbare aanslag (vermindert de afstand van de meetafstand met 170 mm)

Tip: rollenbaan wordt niet meegeleverd, vergeet deze niet bij te bestellen

Order nr.	Orig. nr.	Lengte	Bruikbare verplaat-sing	Ge-wicht	Afmetingen (l x b x h)	Prijs €
		mm	mm	kg	mm	
713383851	LMS10	1000	830	7,00	1100 x 110 x 70	745,00
713383852	LMS20	2000	1830	10,00	2100 x 110 x 70	849,00
713383853	LMS30	3000	2830	12,00	3100 x 110 x 70	985,00
713383854	LMS40	4000	3830	18,00	4000 x 110 x 70	1.095,00

MACHINES

VEILIGHEIDSAFSCHERMING

Veiligheidsafscherming voor boormachines, freesmachines, draaibanken, slijpmachines, ... Kies voor werken in een veilige omgeving.

Onze dikwandige polycarbonaten schermen zijn voorzien van een microscharnelaar n.2 NC contacten, een positief contact zoals omschreven in EN 60947-5-1. Iedere afscherming draagt het CE kenmerk en wordt bovendien geleverd met een eigen CE certificaat. Het beschermt de bediener tegen direct contact met de draaiende delen en spanen en tegen eventueel wegspattend smeermiddel of koelvloeistof.

Investeer in veiligheid! Reduceer het aantal arbeidsongevallen met machines door het aanbrengen van adequate beschermingen. Deze kwalitatieve beschermingen zijn hiervoor uitermate geschikt. Met dit uitgebreide gamma aan beschermkappen, afschermingen, afsluitingen kunt u uw bestaand machinepark in orde stellen aan de geldende machinerichtlijn. Deze producten kunnen zowel door uzelf, uw technische dienst of onze eigen diensten worden geplaatst.

VYNCKIER beschikt over een competente technische dienst die deze beschermingen op een correcte en conforme manier kan plaatsen. Vraag vrijblijvend informatie of een offerte aan zodat de veiligheid van u en uw werknemers hiermee wordt gegarandeerd en uw machinepark voldoet aan de geldende machinerichtlijn. Uw veiligheid is onze zorg!





Voor boormachines

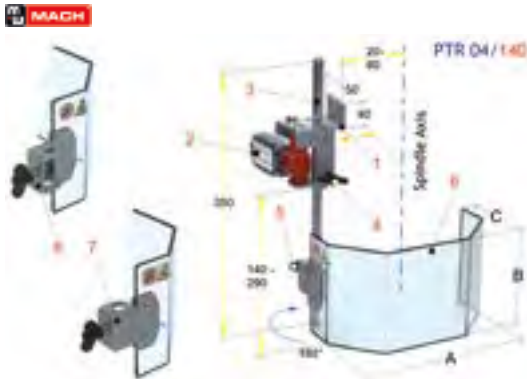

Beschermkap voor tafel- en kleine kolomboormachines.

Troeven

- Derde generatie veiligheidsafscherming voor boormachines "Made in EU"
- Handig ontwerp
- Beschermt de bediener tegen direct contact met de draaiende delen en spanen en tegen wegsplattend smeer- en koelmiddel.
- De enige met een dubbele scherm afstelling
- Polycarbonaat scherm.
- Voorzien van een microschakelaar n.2 NC contacten, is een positief contact zoals omschreven in EN 60947-5-1.

Geschikt voor:

- tafel- en kleine kolomboormachines, universeel toepasbaar

Geleverd met:

- CE kenmerk
- CE certificaat
- Instructie / montage handleiding

Opgepast: een dergelijke booraafscherming vergt telkens aanpassingen om op uw tafel- of kleine boormachine te monteren. Een veiligheidsafscherming dient geplaatst te worden door gekwalificeerd personeel. De geschatte werktijd bedraagt ongeveer 2 werkuren, mits er een noodstopcircuit aanwezig is. Bij vragen of plaatsing, kunt u altijd onze technische dienst contacteren.

Tip: Bij uw keuze van afscherming dient u rekening te houden met de boordiepte, alsook de breedte van de spil, die dient afgeschermd te worden, tevens dient u de veiligheid van de bediener in acht te nemen.

Order nr.	790008786
Orig. nr.	PTR 04/140
A	mm 200
B	mm 140
C	mm 100
Prijs	€ 199,00



Beschermkap voor boormachines volgens ARBO

Troeven:

- Telescopische beschermkap, verticaal instelbaar, zie "B" en "C"
- Afscherming van niet enkel de spindel, maar ook van het gereedschap.
- Beschermt de bediener tegen direct frontaal contact van draaiende onderdelen van de spindel, het gereedschap, spanen en tegen wegsplattend smeer-koelmiddel
- Polycarbonaat scherm
- Voorzien van 180° roterende microschakelaar met 2 NC contacten, positief contact

Geschikt voor:

- Tafel- en kolomboormachines

Geleverd met:

- CE kenmerk
- CE certificaat
- Instructie / montage handleiding

Opgepast: een dergelijke booraafscherming vergt telkens aanpassingen om op uw kolomboormachine te monteren. Een veiligheidsafscherming dient geplaatst te worden door gekwalificeerd personeel. De geschatte werktijd bedraagt ongeveer 2 werkuren, mits er een noodstopcircuit aanwezig is. Bij vragen of plaatsing, kunt u altijd onze technische dienst contacteren.

Tip: Bij uw keuze van afscherming dient u rekening te houden met de boordiepte, alsook de breedte van de spil, die dient afgeschermd te worden, tevens dient u de veiligheid van de bediener in acht te nemen.

Order nr.	790009015
Orig. nr.	PTR 05/180
A	mm 172
B	mm 180
C	mm 180-300
D	mm 114
E	mm 230
Prijs	€ 308,00



Beschermkap voor traditionele kolomboormachines en kleine, radiaal boormachines.

Troeven:

- Derde generatie veiligheidsafscherming voor boormachines "Made in EU"
- Handig ontwerp en de enige met een dubbele scherm afstelling.
- Polycarbonaat scherm.
- Beschermt de bediener tegen direct contact met de draaiende delen en spanen en tegen wegs pattend smeer – koelmiddel.
- Voorzien van een micros chakelaar n.2 NC contacten, is een positief contact zoals omschreven in EN 60947-5-1.

Geschikt voor:

- traditionele grote kolomboormachines, pantografen en gelijkaardige machines.

Geleverd met:

- CE kenmerk
- CE certificaat
- Instructie / montage handleiding

Opgepast: een dergelijke boora fscherming vergt telkens aanpassingen om op uw kolomboormachine te monteren. Een veiligheidsafscherming dient geplaatst te worden door gekwalificeerd personeel. De geschatte werktijd bedraagt ongeveer 2 werkuren, mits er een noodstopcircuit aanwezig is. Bij vragen of plaatsing, kunt u altijd onze technische dienst contacteren.

Tip: Bij uw keuze van afscherming dient u rekening te houden met de boordiepte, alsook de breedte van de spil, die dient afgeschermd te worden, tevens dient u de veiligheid van de bediener in acht te nemen.

Order nr.	790008782	790008784
Orig. nr.	PTR02/130	PTR 02/180
A	mm 230	230
B	mm 130	180
C	mm 115	115
Prijs	€ 249,00	274,00



Beschermkap voor grote kolom- en radiaal boormachines.

Troeven:

- Derde generatie veiligheidsafscherming voor boormachines "Made in EU"
- Verticale afstelling van het scherm met telescopisch arm systeem
- Dikwandig polycarbonaat scherm.
- Voorzien van een micros chakelaar n.2 NC contacten, is een positief contact zoals omschreven in EN 60947-5-1
- Beschermt de bediener tegen direct contact met de draaiende delen en spanen en tegen wegs pattend smeer – of koelmiddel..

Geschikt voor:

- grote kolom- en radiaal boormachines.

Geleverd met:

- CE kenmerk
- CE certificaat
- Instructie / montage handleiding

Opgepast: een dergelijke boora fscherming vergt telkens aanpassingen om op uw grote kolom boormachine of radiaal boormachine te monteren. Een veiligheidsafscherming dient geplaatst te worden door gekwalificeerd personeel. De geschatte werktijd bedraagt ongeveer 2 werkuren, mits er een noodstopcircuit aanwezig is. Bij vragen of plaatsing, kunt u altijd onze technische dienst contacteren.

Tip: Bij uw keuze van afscherming dient u rekening te houden met de boordiepte, alsook de breedte van de spil, die dient afgeschermd te worden, tevens dient u de veiligheid van de bediener in acht te nemen.

Order nr.	790008794	790008796
Orig. nr.	PTR 20/300	PTR 20/350 LINKS
A	mm 300	350
B	mm 200	240
C	mm 150	175
Prijs	€ 420,00	432,00

Voor draaibanken



Beschermkap voor klauwplaat van draaibanken met stalen frame.

Troeven:

- Derde generatie veiligheidsafscherming voor klauwplaten "Made in EU"
- Uitgerust met een stalen frame.
- Thermogevormd scherm in schokbestendig en olie resistent materiaal.
- Beschermt de bediener tegen direct contact met het bovenste deel van de klauwplaat en tegen wegs pattend smeermiddel – koelvloeistof.
- Voorzien van een micros chakelaar n.2 NC contacten, is een positief contact zoals omschreven in EN 60947-5-1.
- De enige, die tot bij de machinekop kan ge positioneerd worden.

Geschikt voor:

- conventionele draaibanken, universeel toepasbaar

Geleverd met:

- CE kenmerk
- CE certificaat
- Instructie / montage handleiding

Opgepast: een klauwplaat afscherming vergt telkens aanpassingen om op uw draaibank te monteren. Een veiligheidsafscherming dient geplaatst te worden door gekwalificeerd personeel. De geschatte werktijd bedraagt ongeveer 2 werkuren, mits er een noodstopcircuit aanwezig is. Bij vragen of plaatsing, kunt u altijd onze technische dienst contacteren.

Tip: Bij uw keuze van grootte van klauwplaat afscherming dient u rekening te houden met de draaidiameter boven het bed, tevens dient u de veiligheid van de bediener in acht te nemen.

Order nr.	790008801 M	790008804 M	790008807 M
Orig. nr.	PTO 01/400	PTO 01/500	PTO 01/600
A	mm 400	500	600
B	mm 235	235	235
C	mm 230	280	330
D	mm 0-150	0-150	0-150
Prijs	€ 367,00	373,00	389,00



Beschermkap voor klauwplaat van draaibanken met monolithisch scherm.

Troeven:

- Derde generatie veiligheidsafscherming voor klauwplaten "Made in EU"
- Uitgerust met een volledig monolithisch scherm.
- Thermogevormd scherm in schokbestendig en olie resistent materiaal.
- Beschermt de bediener tegen direct contact met het bovenste deel van de klauwplaat en tegen wegs pattend smeermiddel – koelvloeistof.
- Voorzien van een micros chakelaar n.2 NC contacten, is een positief contact zoals omschreven in EN 60947-5-1
- De enige, die tot bij de machinekop kan ge positioneerd worden.
- Frontaal en lateraal te bevestigen aan de basis

Geschikt voor:

- conventionele draaibanken, universeel toepasbaar

Geleverd met:

- CE kenmerk
- CE certificaat
- Instructie / montage handleiding

Inhoud:

- 1 Frontaal en lateraal bevestigingsbeugel
- 2 Behuizing veiligheidsschakelaar – 90° rotatie – n.2 NC contacten
- 3 Scherm bevestigingsklem met ondersteuningsarm – in geperst staal
- 4 Monolithisch scherm

Opgepast: een klauwplaat afscherming vergt telkens aanpassingen om op uw draaibank te monteren. Een veiligheidsafscherming dient geplaatst te worden door gekwalificeerd personeel. De geschatte werktijd bedraagt ongeveer 2 werkuren, mits er een noodstopcircuit aanwezig is. Bij vragen of plaatsing, kunt u altijd onze technische dienst contacteren.

Tip: Bij uw keuze van grootte van klauwplaat afscherming dient u rekening te houden met de draaidiameter boven het bed, tevens dient u de veiligheid van de bediener in acht te nemen.

Order nr.	790008810 M	790008812 M
Orig. nr.	PTO 02/300	PTO 02/400
A	mm 300	400
B	mm 200	220
C	mm 200	250
D	mm 0-200	0-190
Prijs	€ 320,00	343,00



PTO 03/300
PTO 03/400
PTO 03/500

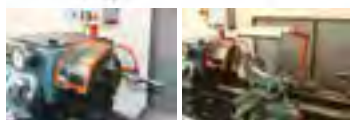

Beschermkap klauwplaat voor draaibanken met doorzichtig scherm.

Troeven:

- Derde generatie veiligheidsafscherming voor klauwplaten "Made in EU"
- Uitgerust met een doorzichtig monolithisch scherm in composiet materiaal.
- De enige die tot bij de machinekop kan gepositioneerd worden.
- Voorzien van een microschemelaar n.2 NC contacten, is een positief contact zoals omschreven in EN 60947-5-1.
- Beschermt de bediener tegen direct contact met het bovenste deel van de klauwplaat en tegen wegs pattend smeermiddel – of koelvloeistof
- Frontaal en lateraal te bevestigen aan de basis.

Geschied voor:

- conventionele draaibanken, universeel toepasbaar

Geleverd met:

- CE kenmerk
- CE certificaat
- Instructie / montage handleiding

Inhoud:

- 1 Frontaal en lateraal bevestigingsbeugel
- 2 Behuizing veiligheidsschemelaar – 90° rotatie – n.2 NC contacten
- 3 Scherm bevestigingsklem met ondersteuningsarm – in geperst staal
- 4 Monolithisch scherm in ovaal composiet materiaal – aluminium – hd polyethylene - aluminium

Opgepast: een klauwplaat afscherming vergt telkens aanpassingen om op uw draaibank te monteren. Een veiligheidsafscherming dient geplaatst te worden door gekwalificeerd personeel. De geschatte werktijd bedraagt ongeveer 2 werkdagen, mits er een noodstopcircuit aanwezig is. Bij vragen of plaatsing, kunt u altijd onze technische dienst contacteren.

Tip: Bij uw keuze van grootte van klauwplaat afscherming dient u rekening te houden met de draaidiameter boven het bed, tevens dient u de veiligheid van de bediener in acht te nemen.

Order nr.	790008814	790008816
Orig. nr.	PTO 03/300	PTO 03/400
A	mm 300	400
B	mm 200	220
C	mm 200	250
D	mm 0-200	0-190
Prijs	€ 320,00	331,00

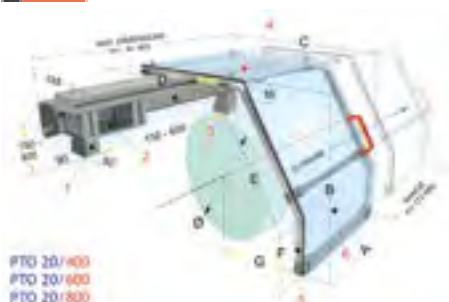

PTO 20/400
PTO 20/600
PTO 20/800

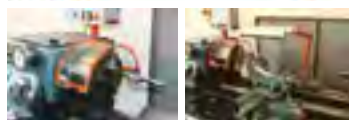

Glijdende beschermkap met groot gedimensioneerd scherm voor draaibanken.

Troeven

- Derde generatie veiligheidsafscherming voor klauwplaten "Made in EU".
- Beschermt de bediener tegen direct contact met draaiende delen van de klauwplaat en wegschietende spanen en tegen wegs pattend smeermiddel – of koelvloeistof.
- Wordt bevestigd op de kop van de draaibank
- Uitgerust met een breed, goed zichtbaar, glijdend scherm,
- Met verschillende afstel mogelijkheden voor een eenvoudige aanpassing op alle draaibanken.
- In schokbestendig en olie resistent materiaal.
- Voorzien van een microschemelaar n.2 NC contacten, is een positief contact zoals omschreven in EN 60947-5-1.

Geschied voor:

- conventionele draaibanken, universeel toepasbaar

Geleverd met:

- CE kenmerk
- CE certificaat
- Instructie / montage handleiding

Opgepast: een glijdende veiligheidsafscherming vergt telkens aanpassingen om op uw draaibank te monteren. Een veiligheidsafscherming dient geplaatst te worden door gekwalificeerd personeel. De geschatte werktijd bedraagt ongeveer 4 werkdagen, mits er een noodstopcircuit aanwezig is. Bij vragen of plaatsing, kunt u altijd onze technische dienst contacteren.

Tip: Bij uw keuze van grootte van klauwplaat afscherming dient u rekening te houden met de draaidiameter boven het bed, tevens dient u de veiligheid van de bediener in acht te nemen.

Order nr.	790008828	790008829	790008830
Orig. nr.	PTO 20/400	PTO 20/600	PTO 20/800
A	mm 450	450	450
B	mm 430	520	640
C	mm 655	855	1065
D	mm 480	640	800
E	mm 350	430	530
F	mm 125	150	180
G	mm 280-540	320-740	370-950
Diameter	mm 400-500	600-700	800-900
Prijs	€ 1.355,00	1.409,00	1.489,00

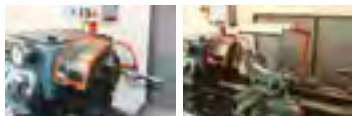

Beschermkap voor beitelhoeder voor draaibanken

Troeven:

- Derde generatie veiligheidsafscherming voor beitelhoeder "Made in EU"
- Specifiek multi verstelbare afscherming, voor op de wagen van een draaibank.
- Gecombineerd met de veiligheidsafscherming voor de klauwplaat, biedt dit een uitzonderlijke bescherming aan van de bediener.
- Thermogevormd scherm in schokbestendig en olie resistent materiaal.
- Voorzien van een microschakelaar n.2 NC contacten, is een positief contact zoals omschreven in EN 60947-5-1.
- Beschermt de bediener tegen direct contact met draaiende delen van de klauwplaat en wegschietende spanen en tegen wegsputtend smeermiddel – koelvloeistof.

Geschikt voor:

- conventionele draaibanken, universeel toepasbaar

Geleverd met:

- CE kenmerk
- CE certificaat
- Instructie / montage handleiding

Wordt bevestigd aan de achterzijde van de wagen. Het scherm, ondersteunt door de gelede armen dankzij een kogelgewricht, is volledig regelbaar en beschermt tegen spanen. Schermen kunnen afzonderlijke aangekocht worden.

Opgepast: een beitelhoeder afscherming vergt telkens aanpassingen om op uw draaibank te monteren. Een veiligheidsafscherming dient geplaatst te worden door gekwalificeerd personeel. De geschatte werktijd bedraagt ongeveer 3 werkuren, mits er een noodstopcircuit aanwezig is. Bij vragen of plaatsing, kunt u altijd onze technische dienst contacteren.

Tip: Bij uw keuze van grootte van beitelhoeder afscherming dient u rekening te houden met de afmetingen de bevestigingsbeugel om deze te kunnen monteren op de wagen, tevens dient u de veiligheid van de bediener in acht te nemen.

Order nr.	790008823 M	790008825 M	790008826 M
Orig. nr.	PTO 10/350	PTO 10/435	PTO 11/435
A	mm 350	400	400
B	mm 300	350	350
C	mm 280	310	310
D	mm 550	550	800
Prijs	€ 415,00	489,00	609,00

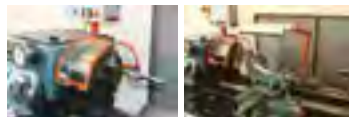

Veiligheidsafscherming rolgordijn voor de spindels van een draaibank leispil en voedingsgas.

Troeven:

- Derde generatie veiligheidsafscherming voor leispil en voedingsgas "Made in EU"
- Bestaat uit twee eenheden van zelfprollende rollen, vervaardigd met scheur- en oliebestendige draad.
- Gecombineerd met de veiligheidsafscherming voor de klauwplaat en beitelaafscherming, biedt dit een optimale bescherming aan van de bediener.
- Uit twee delen die worden bevestigd aan de twee uiteinden van de wagen, uitgerust met zelfgeleidende rollen, worden bediend door de meervoudige veren binnenin.
- De beschermende band is geproduceerd uit sterk textiel en is resistent tegen koelvloeistoffen en scheuren.
- Iedere eenheid is specifiek ontworpen voor zijn kant van de wagen en voorzien van geschikte bevestigingsbeugels.
- Tijdens het verplaatsen van de wagen, worden de twee eenheden vanzelf op- en afgerold, en beschermen ze zo constant de bediener tegen eventueel vastlopende werkkledij.

Geschikt voor:

- Ontworpen om frontaal te bevestigen voor de moerwijs en de voedingsassen van een draaibank.

Opgepast: een dergelijke veiligheidsafscherming vergt telkens aanpassingen om op uw draaibank te monteren. Een veiligheidsafscherming dient geplaatst te worden door gekwalificeerd personeel. De geschatte werktijd bedraagt ongeveer 2 werkuren. Bij vragen of plaatsing, kunt u altijd onze technische dienst contacteren.

Tip: Bij uw keuze van afscherming dient u rekening te houden met de hoogte, die dient afgeschermd te worden van leispil en voedingsgas, en centerlengte van uw draaibank, tevens dient u de veiligheid van de bediener in acht te nemen.

Order nr.	790008835 M	790008836 M	790008837 M	790008838 M
Orig. nr.	PAT 01/120	PAT 01/150	PAT 01/200	PAT 01/300
A	mm 1200	1500	2000	3000
B	mm 150	200	200	250
Prijs	€ 559,00	669,00	919,00	1.090,00

Voor freesmachines



Beschermkap voor freesmachines.

Troeven:

- Derde generatie veiligheidsafscherming voor universele freesmachines "Made in EU"
- Dankzij een bewezen systeem van wrijvende gelede armen, is het de enige die uiterst veelzijdig en beweegbaar is.
- Thermogevormd scherm in schokbestendig en olie resistent materiaal.
- Voorzien van een microschemelaar n.2 NC contacten, is een positief contact zoals omschreven in EN 60947-5-1.
- Beschermt de bediener tegen direct contact met de draaiende delen van de verticale spindel en spanen en tegen wegsplastend smeer – koelmiddel.

Geschied voor:

- Frequent veranderende werkoperaties bij freesbewerkingen
- Torenfreesmachines, universele freesmachines

Geleverd met:

- CE kenmerk
- CE certificaat
- Instructie / montage handleiding

Bevestiging aan de basis flank, uitgerust met breed volledig doorzichtig scherm met dubbel openend systeem: 1 = scherm kan verticaal geopend worden met zijn positieknop – 2 = zwevend buiten het werkveld. Compleet met dubbele microschemelaar. Schermen zijn apart verkrijgbaar.

Opmerking: specificeer de montagezijde door de volgende suffix toe te voegen: / DX = rechts - / SX = links.

Opgepast: een veiligheidsafscherming vergt telkens aanpassingen om op uw universele freesmachine te monteren. Een veiligheidsafscherming dient geplaatst te worden door gekwalificeerd personeel. De geschatte werktijd bedraagt ongeveer 3 werkuren, mits er een noodstopcircuit aanwezig is. Bij vragen of plaatsing, kunt u altijd onze technische dienst contacteren.

Tip: Bij uw keuze van afscherming dient u rekening te houden met uw type freesmachine, meer bepaald de plaats waar de afscherming dient gemonteerd te worden, opteert uw voor een linkse of rechtse versie. Deze afscherming worden het meest geplaatst op universele freesmachines met enkel een verticale spindel, tevens dient u de veiligheid van de bediener in acht te nemen.

Order nr.	790008859	790008860	790008864	790008865
nr.	M	M	M	M
Orig. nr.	PFR 02/625/ DX	PFR 02/625/ SX	PFR 02/730/ DX	PFR 02/730/ SX
A	mm 620	620	725	725
B	mm 250	250	300	300
C	mm 170	170	200	200
D	mm 405	405	430	430
Zijde	Rechts	Links	Rechts	Links
Prijs	€ 849,00	849,00	885,00	885,00

Voor slijpmolens



Beschermkap voor slijpmolens en bandschuurmachines

Troeven

- Derde generatie veiligheidsafscherming voor boormachines "Made in EU"
- Handig ontwerp
- Beschermt de bediener tegen direct contact met de draaiende delen en spanen en tegen wegsplastend smeer – en koelmiddel.
- Polycarbonaat scherm, in schokbestendig materiaal.
- Het rubberen aansluitstuk in versterkt polyamide laat toe deze universele beschermkap te monteren op verschillende machines.

Geschied voor:

- Slijpmolens, bandschuurmachines, etc.

Order nr.	790008891	790008893	790008892
nr.	M	M	M
Orig. nr.	PMA 02/112	PMA 02/216	PMA 02/112/SC
A	mm 160	200	
B	mm 145	185	
Prijs	€ 69,90	71,90	31,50

metallkraft



Magnetische spanenverwijderaar voor het veilig verwijderen van spanen.

Werkking:

- De Zyklon magnetische spanenverwijderaar neemt moeiteloos alle spanen magnetisch op, ook in de meest ontoegankelijke plaatsen.
- De opname van de spanen gebeurt door de magnetische oppervlakte, het verwijderen van de spanen gebeurt door het eenvoudig demagnetiseren door de hendel in te drukken.

Geschied voor:

- Boormachines, freesmachines, zaagmachines, draaibanken, etc.

Order nr.	713850010
nr.	M
Orig. nr.	ZYKLON
Prijs	€ 46,90

Boorhouders

Cliva



Snelspan boorkop. Industriële kwaliteit. 3 bekken.

Troeven:

- Grote klemkracht
- 3 geharde en geslepen bekken
- Doorboord met de mogelijkheid om aan te spannen voor zowel links als rechtsdraaiend
- Met metalen behuizing voor betere duurzaamheid
- Boorhouder met zelfspannend blokkeringsstelsysteem.

Geschikt voor:

- Klopboormachines met aansluiting 1/2"x20 en 3/8"x24

Order nr.	Orig. nr.	Capaciteit	Aan- sluiting	Buitendia- meter	Lengte mm	Prijs €
209920305	209920305	0,8-10	1/2"x20	41	54-64	12,90
209920503	209920503	1,5-13	1/2"x20	43	62-75	15,90
209920206	209920206	0,8-10	3/8"x24	41	54-64	12,90
209920404	209920404	1,5-13	3/8"x24	43	62-75	15,90

MACH



Verloopadaptor voor UNF 3/8x24 boorhouders in UNF 1/2x20 boormachines.

Order nr.	749551102	€
Adaptor	3/8" naar 1/2"	
Prijs	7,40	

MACH



Afzonderlijke sleutels voor tandkransboorkop.

Order nr.	Sleuteltype	Diameter top mm	Aantal tanden	Prijs €
03691755	KS10	8	12	11,90
03691458	KH810	6	11	3,10
200830404	KS2	6	12	3,30
200830503	KS3	8	12	4,90

MACH



Tandkrans boorhouder. Industriële kwaliteit.

Troeven:

- Met sleutel
- 3 bekken. Bekken zijn gehard en geslepen
- Met hoge spankracht
- Links-rechtsdraaiend

Geschikt voor:

- Voor gebruik op klopboormachines, boormachines, draaibanken en houtbewerkingsmachines

Tip geleverd zonder kegeldoorn, vergeet deze niet bij te bestellen.

Order nr.	Aansluiting	Capaciteit mm	Sleuteltype	Diameter kop mm	Lengte mm	Prijs €
200850600	1/2"x20	1,5-13	KS2	42	59	7,60
200820207	B16	1-13	KS3	52	69	20,50
200820306	B18	3-16	KS3	49,5	75	25,90
200820405	B18	5-20	KS4	65	92	50,90

OPTIMUM



Snelspanboorkop. Industriële kwaliteit.

Troeven:

- 3 bekken.
- Snelklemming en zelfklemmend.
- Met kogellager.
- De bekken zijn gehard en geslepen.
- Opname van de boorkop volgens DIN238.

Geschikt voor:

- Voor montage op boormachines, freesmachines en draaibanken.

Tip geleverd zonder kegeldoorn, vergeet deze niet bij te bestellen.

Order nr.	Aansluiting	Capaciteit mm	Merk	Prijs €
713050608	B16	0-8	Optimum	40,90
713050610	B16	0-10	Optimum	40,90
713050623	B16	0-13	Optimum	39,90
713050626	B16	0-16	Optimum	48,50
713050630	B18	0-16	Optimum	46,90
749661910	1/2"x20	3-16	Metalworks	74,90
713050656	B16	1-13	Röhms	53,50
713050657	B16	3-16	Röhms	58,50



Monoblock boorkoppen. Industriële kwaliteit. Snelspan boorkop met geïntegreerde kegeldoorn.

Troeven:

- met geïntegreerde kegeldoorn
- hogere rondloopnauwkeurigheid beter dan 0,05 mm
- hoger toerentalbereik

Geschied voor:

- tafel- of kolomboormachine met variabele spijnsnelheden.
- draaibanken
- 790003539 en 790003540 geschikt voor freesmachines met DIN2080 aansluiting

Order nr.	Aansluiting	Capaciteit mm	Prijs €
713050572	MK2	0,3-13; tot 8000 tpm	87,50
713050571	MK2	0,3-16; tot 6'000 tpm	99,90
713050585	MK3	0,3-13; tot 8'000 tpm	87,50
713050573	MK3	0,3-16; tot 8'000 tpm	99,90
713050587	MK4	0,3-13; tot 6'000 tpm	90,50
713050574	MK4	0,3-16; tot 6'000 tpm	99,90
790003539	ISO40	1-13; tot 6000 tpm	143,00
790003540	ISO40	3-16; tot 6.000 tpm	149,00



Monoblock boorkop met geïntegreerde konus MAS403 BT

Troeven:

- Werk nauwkeurig
- Voorkomt dat de boorhouder op het werkstuk valt
- Eenvoudig aan te spannen met sleutel
- Oppervlakte hardheid HRC58-62

Geschied voor:

- Meeste CNC machines met een MAS403 BT opname.
- BT30 kunnen uiteraard ook gebruikt worden op onze F3, F4 en F80
- BT40 op onze F105

Tip: Vergeet uw aantrekbouten / pull studs niet bij te bestellen voor uw F3 / F4 / F80: 790003068

Order nr.	Orig. nr.	Capaciteit	Aansluiting	Diameter top mm	Lengte mm	Prijs €
790003006	MBH3108	0,5-8 mm; max. 8000 tpm	BT30	36	80	109,00
790003007	MBH3113	1-13 mm; max. 8000 tpm	BT30	50	100	137,00
790003008	MBH3116	3-16 mm; max. 8.000 tpm	BT30	57	110	148,00
790003009	MBH4113	1-13 mm; max. 8000 tpm	BT40	50	100	161,00
790003010	MBH4116	3-16 mm; max. 8000 tpm	BT40	57	105	172,00
790003011	MBH5113	1-13 mm; max. 6000 tpm	BT50	50	100	195,00
790003012	MBH5116	3-16 mm; max. 6000 tpm	BT50	57	110	206,00

KEGELDOORNS

Verschillende kegeldoorns voor het opnemen van boorkoppen in uw machine. Dit is van essentieel belang bij aankoop van een boorkop. Kegeldoorns met draadopname voor boor-freesmachines. Kegeldoorns met ISO konus DIN2080 voor freesmachines. Kegeldoorns met morse konus opname DIN228 voor boormachines. Gehard en geslepen.



Kegeldoorns met morse konus MK opname DIN228 voor boormachines en draaibanken.

Troeven:

- Gehard en geslepen.
- Morse konus opname volgens DIN228

Geschied voor:

- Deze kegeldoorns kunnen gebruikt worden op alle boormachines, zoals B16, B23PRO, B28H, etc.
- conventionele draaibanken om te plaatsen in het tegenpunt van de draaibank, zoals TU2004V, TU2506, TH4610, etc.
- 790023079 ingekorte versie MK1 voor gebruik bij TU1503V

Tip: eerst nazien met welke spindel uw machine is uitgerust en dan de geschikte kegeldoorn uitkiezen.

Order nr.	Aansluiting MK	Boorkopkant	Prijs €
713050658	1	B16	5,40
790023079	1	B16	11,90
713050659	2	B16	5,40
749642018	2	B18	4,70
713050660	3	B16	6,60
749643018	3	B18	5,70
713050661	4	B16	10,90
749644018	4	B18	8,30
713050675	5	B16	13,50
713050676	6	B16	23,90



Kegeldoorns Morse konus met langs de machinezijde draadopname, volgens DIN228 - vorm A.

Troeven:

- Gehard en geslepen.
- Met aantrekdraad
- Volgens DIN228 - vorm A

Geschied voor:

- Deze kegeldoorns kunnen gebruikt worden op alle boor-freesmachines, zoals BF20, MB4P, etc

Tip: eerst nazien met welke spindel uw machine is uitgerust en dan de geschikte kegeldoorn uitkiezen.

Order nr.	713050670	713050669	790023034
Aansluiting	MK 2/M10	3/M12	4/M16
Boorkopkant	B16	B16	B16
Prijs €	5,90	7,00	8,20





Kegeldoorns ISO opnamekonus DIN2080, volgens DIN238.



Troeven

- Gehard en geslepen
- Met opnamekonus ISO DIN2080
- Volgens DIN238

Geschikt voor:

- Deze kegeldoorns kunnen gebruikt worden op de meeste freesmachines en sommige boorfreesmachines, zoals MT50, MT100, MT200, etc.

Tip: eerst nazien met welke spindel uw machine is uitgerust en dan de geschikte kegeldoorn uitkiezen.

Order nr.	713352069 	713352070 	790024004 
Aansluiting	ISO 30/M12	40/M16	50/M24
Boorkopkant	B16	B16	B16
Prijs	€ 34,90	34,90	47,90









Reductiehuizen Morse Konus opname - DIN2185.

Troeven:

- Geslepen en gehard.
- Met Morse Konus opname
- Volgens DIN2185

Geschikt voor:

- gebruik in boormachines en tegenpunt van draaibanken.
- het reduceren van uw spil zodat u andere MK boren kunt opnemen

Order nr.	Uitwendig MK	Inwendig MK	Prijs €
749611021 	2	1	4,70
749611031 	3	1	7,50
713050663 	3	2	5,70
713050666 	4	1	7,50
713050665 	4	2	7,50
713050664 	4	3	7,90
749611052 	5	2	15,50
749611053 	5	3	15,90
749611054 	5	4	15,90







Reductiehuls Morse konus DIN 2186 met langs de machinezijde draadopname.

Troeven:

- Geslepen en gehard.
- Morse Konus met draadopname machinezijde
- Volgens DIN2186

Geschikt voor:

- Voor gebruik in boorfreesmachines, bvb MK4/M16: B40E, B40PE, MB4/P

Order nr.	Uitwendig	Inwendig	Prijs €
790023086 	MK2/M10	MK1	6,90
790024032 	MK3/M12	MK2	7,10
790023036 	MK4/M16	MK2	8,30
790023037 	MK4/M16	MK3	8,30





Verleng- en vergroothuls Morse Konus DIN2187.

Troeven:

- Geslepen en gehard.
- Een vergroothuls wordt gebruikt als uw conische boor een groter nummer van konus heeft, dan de spil van uw boormachine of tegenpunt van uw draaibank.
- Verlenghuls wordt gebruikt om uw spil van uw machine te verlengen.

Geschikt voor:

- Boormachines en draaibanken

Tip: hou rekening met het vermogen van uw boormachine en draaibank.

Order nr.	Uitwendig MK	Inwendig MK	Totale lengte mm	Prijs €
749611012 	1	2	160	10,50
749611021 	2	2	175	11,50
713050667 	2	3	196	23,90
749611042 	2	4	221	16,90
749611033 	3	3	215	14,90
713050668 	3	4	240	35,90
749611053 	3	5	275	25,50
749611044 	4	4	265	22,90
749611054 	4	5	300	32,90













MK-houder DIN6383 volgens ISO konus DIN2080 voor opname conische boren.

Kenmerken:

- Geslepen en gehard.
- Met opnamekonus ISO DIN2080
- Volgens DIN6383

Geschikt voor:

- Voor het opnemen van conische boren in ISO spindel van boor-freesmachines en freesmachines.

Order nr.	Uitwendig ISO	Inwendig MK	Prijs €
790002952 	30	2	41,90
790002953 	30	3	41,90
790002955 	40	2	46,90
790002956 	40	3	46,90
790002957 	40	4	46,90
790002958 	50	2	60,50
790002959 	50	3	60,50
790002960 	50	4	60,50
790002961 	50	5	60,50





Reductiehouders MAS403 BT30 met opname voor het opnemen van Morse Konus boren.



Troeven:

- Concentriciteit en uitloop minder of gelijk aan 0.005 mm
- Oppervlakte hardheid HRC58-62
- Worden vervaardigd uit gecarboniseerd gelegeerd staal

Geschikt voor:

- De meeste CNC machines met een MAS-403 BT30 opname, uiteraard ook op onze F3, F4 en F80.

Tip: Vergeet uw aantrekbouten / pull studs niet bij te bestellen voor uw F3 / F4 / F80, 790003068

Order nr.	790003013 	790003014 
Orig. nr.	BT30-60-MK2	BT30-80-MK3
Opname	BT30-MK2	BT30-MK3
Lengte	mm 108.4	mm 128.4
D	mm 32	mm 40
D1	mm 31.75	mm 31.75
Gewicht	kg 1,00	kg 1,00
Afmetingen (l x b x h)	mm 110 x 50 x 50	mm 110 x 50 x 50
Prijs	€ 61,90	€ 61,90



Uitdrijver voor Morse Konus houder

Troeven:

- Universeel model
- Volgens DIN317
- Zwarte, geharde uitvoering (zonder handgreep)

Geschikt voor:

- Om eenvoudig Morse Konus gereedschappen te verwijderen uit de spindel of houders.
- boormachines, freesmachines en draaibanken

Order nr.	891020430 
Voor type	Universeel model
Prijs	€ 15,50



Halfautomatische uitdrijver voor Morse Konus houders

Troeven:

- Halfautomatisch model
- Volgens DIN318
- door het handvat kan een hefboom effect gecreëerd worden, waardoor het eenvoudiger wordt een boor uit de spindel te drijven.

Geschikt voor:

- Om eenvoudig morse konus gereedschappen te verwijderen uit de spindel.
- boormachines, freesmachines en draaibanken

Order nr.	713050636 	713050637 
Voor type	Voor MK1-MK3	Voor MK4-MK6
Prijs	€ 21,50	€ 27,50







Adapter met morse konus aansluiting (kant machine) en voor kernboren met Weldon 19 mm.

Troeven:

- Gebruik de toepassing van kernboren op uw stationaire boormachines
- Efficiënter gaten boren door meerdere tanden, waardoor meer voeding kan gegeven worden en vlugger kan gewerkt worden.

Geschikt voor:

- Voor stationaire boormachines. zowel tafel als kolommodel MK2, MK3 of MK4.
- Maar ook magneetboormachines uitgerust met een Morse konus aansluiting

Order nr.	790302631 	790302633 	790302635 
Orig. nr.	KBH2	KBH3	KBH4
Snijdiepte	mm 25/50	mm 25/50	mm 25/50
Prijs	€ 49,50	€ 54,50	€ 61,50

MACHINES



Adapter voor kernboren met langs de machinezijde draadopname. werkt met kernboren Weldon 19.05 mm.

Troeven:

- Gebruik de toepassing van kernboren op uw boorfreemachines
- Efficiënter gaten boren door meerdere tanden, waardoor meer voeding kan gegeven worden en vlugger kan gewerkt worden.

Geschied voor:

- boorfreemachines MK2/M10, MK3/M12 of MK4/M16.

Order nr.	790302632	790302634	790302636
Orig. nr.	KBH210	KBH312	KBH416
Snijdiepte mm	25/50	25/50	25/50
Prijs €	50,90	54,50	61,50



Koffer met ER spantanghouder, spantangen DIN6499 en haaksleutel.

Troeven:

- Diverse opnames van de spantang houder mogelijk: MK2/M10, MK3/M12, DIN2080 ISO30, DIN2080 ISO40.
- Ook kan er een keuze gemaakt worden uit verschillende soorten ER spantangen ER25, ER32 en ER40.

Standaard geleverd met:

- 1 spantang houder
- 1 haaksleutel
- meerdere individuele ER spantangen DIN6499.
- Afsluitbare aluminium opbergkoffer met inleg

Order nr.	Orig. nr.	Aan-sluiting MK	Aan-sluiting DIN6499	ER	Maat span-tangen mm	Aan-tal	Prijs €
713352052	SPS021025		2M10	ER25	4 - 6 - 8 - 10 - 12 - 16	6	144,00
713352053	SPS021032		2M10	ER32	6 - 8 - 10 - 12 - 16 - 20	6	156,00
790002076	SPS031232		3M12	ER32	6 - 8 - 10 - 12 - 16 - 20	6	167,00
790002085	SPS041640		4M16	ER40	4 - 6 - 8 - 10 - 12 - 16 - 20 - 25	8	178,00
713352054	SPS3032	ISO30		ER32	6 - 8 - 10 - 12 - 16 - 20	6	167,00
713352055	SPS4032	ISO40		ER32	4 - 6 - 8 - 10 - 12 - 16 - 20	7	178,00
790002019	SPS4040	ISO40		ER40	4 - 6 - 8 - 10 - 12 - 16 - 20 - 25	8	189,00
790002026	SPS5040	ISO50		ER40	4 - 6 - 8 - 10 - 12 - 16 - 20 - 25	8	230,00

Freeshouder



Set directe spantangen Morse Konus met draadopname.

Troeven:

- Budgetvriendelijk
- Directe spantangen, zonder gebruik van spantanghouder.
- Met MK2/M10 of MK3/M12 opname.

Geschied voor:

- boorfreemachines tafelmodel

Tip: Spantangen zijn eveneens apart leverbaar.

Order nr.	713351980	713352014
Aantal stuks	5	6
Aansluiting	MK 2M10	3M12
Maten	4 - 6 - 8 - 10 - 12	4 - 6 - 8 - 10 - 12 - 16
D mm	18	24,1
L mm	68	86
Prijs €	60,50	61,90



Afzonderlijke ER spantangenhouders Morse Konus volgens DIN228 voor spantangen ER DIN6499.

Troeven:

- Met Morse Konus opname volgens DIN228 (draadopname)
- Diverse opnames van de spantang houder mogelijk: MK2/M10, MK3/M12, MK4/M16
- Ook kan er een keuze gemaakt worden uit verschillende soorten ER spantangen ER25, ER32 en ER40.

Geschikt voor:

- Boorfreesmachines
- cilindrische als weldon frezen op te nemen

Tip: Vergeet uw ER sleutel niet bij te bestellen

Order nr.	Aansluiting	Voor spantang	L1 mm	D mm	Prijs €
	MK				
790002051	2M10	ER25	57.7	42	35,90
790002052	2M10	ER32	65.7	50	55,50
790002056	3M12	ER25	55.7	42	36,90
790002053	3M12	ER32	65.7	50	55,50
790002057	4M16	ER32	74.2	50	63,50
790002058	4M16	ER40	69.7	63	64,50



Afzonderlijke ER spantangenhouders volgens DIN2080 voor spantangen ER DIN6499.

Troeven:

- Met ISO konusopname DIN2080
- Diverse opnames van de spantang houder mogelijk: ISO30, ISO40, ISO50.
- Ook kan er een keuze gemaakt worden uit verschillende soorten ER spantangen ER25, ER32 en ER40.

Geschikt voor:

- torenfreesmachines, universele freesmachines
- cilindrische frezen als frezen met Weldon schacht

Tip: Vergeet uw ER sleutel niet bij te bestellen!

Order nr.	Aansluiting	Voor spantang	L1 mm	D mm	Prijs €
790002006	ISO30	ER25	63	42	46,50
790001998	ISO30	ER32	63	50	39,50
790002007	ISO40	ER25	60	42	47,90
790002000	ISO40	ER32	70	50	61,90
790002001	ISO40	ER40	60	63	47,90
790002003	ISO50	ER32	70	50	69,90
790002004	ISO50	ER40	70	63	69,90



ER sleutel type S

Geschikt voor:

- De verschillende ER spanmoeren.

Order nr.	790007227	790007228	790023039
Orig. nr.	ER25S	ER32S	ER40S
Maat	mm 37	45	58
Lengte	mm 210	250	290
Type gereedschap	ER25	ER32	ER40
Prijs	€ 7,00	7,70	8,30



Koffer met set complete ER spantangen DIN6499.

Troeven:

- Sets ER spantangen zijn gemaakt van speciaal elastisch staal 65Mn en zijn geproduceerd volgens DIN6499
- Ze hebben een precisie nauwkeurigheid van 0.015
- Sterke klemmingskracht.
- Hardheid van HRC44-48.
- Mogelijkheden ER20, ER25, ER32 en ER40.
- Standaard precisie.
- Afsluitbare aluminium opbergkoffer met inleg.

Tip: te gebruiken bij spantanghouder ER, vergeet deze niet bij te bestellen alsook de corresponderende haakse sleutel.

Order nr.	790600102	713441109	713441122	790007210
Orig. nr.	SSER20	SSER25	SSER32	SSER40
Aantal stuks	13	15	18	23
Maat spantangen	mm 1-2-3-4-5-6-7-8-9-10-11-12-13	2-3-4-5-6-7-8-9-10-11-12-13-14-15-16	3-4-5-6-7-8-9-10-11-12-13-14-15-16-17-18-19-20	4-5-6-7-8-9-10-11-12-13-14-15-16-17-18-19-20-21-22-23-24-25-26
Type spantangen	ER20	ER25	ER32	ER40
Gewicht	kg 1,20	1,40	1,64	3,00
Prijs	€ 91,50	156,00	200,00	212,00

SPANTANGEN ER DIN6499

ER spantangen. ER spantangen zijn gemaakt van speciaal elastisch staal 65Mn en zijn geproduceerd volgens DIN6499, ze hebben een precisie nauwkeurigheid van 0,015 en een sterke klemmingskracht. Hardheid van HRC44-48. ER25, ER32 en ER40. Standaard precisie, A klasse op aanvraag.

ER spantangen afmetingen:

	D	H7	D	D1	D2	L	L1	L2	L3	Cap.
	mm	mm	mm	mm	mm	mm	mm	mm	mm	kg
ER25	1,0 - 2,5	25	26	22	34	6,66	5	3,1	0,5	
	2,5 - 16,0	25	26	22	34	6,66	5	3,1	1	
ER32	2,0 - 2,5	32	33	29,2	40	7,16	5,5	3,6	0,5	
	2,5 - 20	32	33	29,2	40	7,16	5,5	3,6	1	
ER40	3,0 - 26,0	40	41	36,2	46	7,66	7	4,1	1	



MACH



Afzonderlijke spantangen ER25 DIN6499

Troeven:

- Volgens DIN6499
- Hardheid van HRC44-48
- Gepolierde versie
- Voorzien van 16 groeven
- Hoge nauwkeurigheid 0,015 mm, verkregen door CNC slijpmachine
- ER25 heeft een bereik tussen de 2 en 16 mm, verkrijgbaar per mm.

Tip: op ER spantangen staan telkens twee afmetingen, bvb 3-2, waarvan 3 de maximum diameter is en 2 de minimum.

Order nr.	Orig. nr.	Diameter mm	Prijs €
790001705	ER2502	2-1	6,20
790001706	ER2503	3-2	6,20
790001707	ER2504	4-3	6,20
790001708	ER2505	5-4	6,20
790001709	ER2506	6-5	6,20
790001710	ER2507	7-6	6,20
790001711	ER2508	8-7	6,20
790001712	ER2509	9-8	6,20
790001713	ER2510	10-9	6,20
790001714	ER2511	11-10	6,20
790001715	ER2512	12-11	6,20
790001716	ER2513	13-12	6,20
790001717	ER2514	14-13	6,20
790001718	ER2515	15-14	6,20
790001719	ER2516	16-15	6,20

MACH

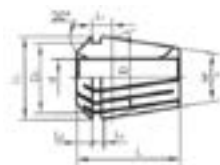

Afzonderlijke spantangen ER32 DIN6499

Troeven:

- Volgens DIN6499
- Hardheid van HRC44-48
- Gepolierde versie
- Voorzien van 16 groeven
- Hoge nauwkeurigheid 0,015 mm, verkregen door CNC slijpmachine
- ER32 heeft een bereik tussen de 3 en 20 mm, verkrijgbaar per mm.

Tip: op ER spantangen staan telkens twee afmetingen, bvb 3-2, waarvan 3 de maximum diameter is en 2 de minimum.

Order nr.	Diameter mm	Prijs €
790001720	3-2	6,80
790001721	4-3	6,80
790001722	5-4	6,80
790001723	6-5	6,80
790001724	7-6	6,80
790001725	8-7	6,80
790001726	9-8	6,80
790001727	10-9	6,80
790001728	11-10	6,80
790001730	13-12	6,80
790001734	17-16	6,80
790001733	16-15	6,80
790001731	14-13	6,80
790001729	12-11	6,80
790001732	15-14	6,80
790001735	18-17	6,80
790001736	19-18	6,80
790001737	20-19	6,80

MACH



Afzonderlijke spantangen ER40 DIN6499

Troeven:

- Volgens DIN6499
- Hardheid van HRC44-48
- Gepolierde versie
- Voorzien van 16 groeven
- Hoge nauwkeurigheid 0,015 mm, verkregen door CNC slijpmachine
- ER40 heeft een bereik tussen de 3 en 26 mm, verkrijgbaar per mm.

Tip: ER spantangen worden telkens met twee maten opgegeven, bvb 3-2, waarvan 3 de maximum diameter opname is en 2 de minimum opname.

Order nr.	Type	Diameter mm	Prijs €
790001738 ^M	ER40	3-2	7,90
790001739 ^M	ER40	4-3	7,90
790001740 ^M	ER40	5-4	7,90
790001741 ^M	ER40	6-5	7,90
790001742 ^M	ER40	7-6	7,90
790001743 ^M	ER40	8-7	7,90
790001744 ^M	ER40	9-8	7,90
790001745 ^M	ER40	10-9	7,90
790001746 ^M	ER40	11-10	7,90
790001747 ^M	ER40	12-11	7,90
790001748 ^M	ER40	13-12	7,90
790001749 ^M	ER40	14-13	7,90
790001750 ^M	ER40	15-14	7,90
790001751 ^M	ER40	16-15	7,90
790001752 ^M	ER40	17-16	7,90
790001753 ^M	ER40	18-17	7,90
790001754 ^M	ER40	19-18	7,90
790001755 ^M	ER40	20-19	7,90
790001756 ^M	ER40	21-20	7,90
790001757 ^M	ER40	22-21	7,90
790001758 ^M	ER40	23-22	7,90
790001759 ^M	ER40	24-23	7,90
790001760 ^M	ER40	25-24	7,90
790001761 ^M	ER40	26-25	7,90

OPTIMUM



Set van 17 cilindrische spantangen 5C, norm 385E

Troeven:

- Norm 385 E
- Spantangen zijn behandeld en geslepen

Geschikt voor:

- Universele spantang inrichtingen
- Te gebruiken bij 713441554, 713441556 en 713441558

Geleverd met:

- 17 spantangen 5C van 3 tot 25 mm
- In Aluminium opbergkoffer

Order nr.	713441509 ^M
Prijs €	230,00

MACH



Gecombineerde vlakfrees houders DIN6362, langs en dwars gebruik, met aansluiting morse konus met draadopname DIN228.

Troeven:

- Langs en dwars gebruik
- Gehard en geslepen
- Met Morse Konus aansluiting met draad DIN228
- Volgens DIN6362

Geschikt voor:

- Het opnemen van vlakfrees, mantelkopfrees en schijffrees van alle gekende merken met een as gat van 16 tot 32 mm.

Andere maten op aanvraag.

Order nr.	Aansluiting MK	Boring vlakfrees d	Breedte mm	Prijs €
713352102 ^M	2M10	16	8	47,90
790007230 ^M	2M10	22	10	47,90
790007231 ^M	2M10	27	12	47,90
790007232 ^M	3M12	22	10	51,50
790002949 ^M	3M12	27	12	51,50
713350456 ^M	3M12	32	14	51,50
790700216 ^M	4M16	16	8	56,50
790002962 ^M	4M16	22	10	56,50
790002950 ^M	4M16	27	12	56,50
790002963 ^M	4M16	32	14	56,50

OPTIMUM



Gecombineerde vlakfrees houders DIN6358, langs en dwars gebruik, met konus ISO DIN2080.

Troeven:

- Langs en dwars gebruik
- Gehard en geslepen
- Met konus aansluiting ISO volgens DIN2080
- Volgens DIN6358

Geschikt voor:

- Het opnemen van vlakfreesen, mantelkopfreesen, schijffreesen van alle gekende merken met een as gat van 22 tot 32 mm.

Andere maten op aanvraag.

Order nr.	Aansluiting ISO	Boring vlakfrees d	Breedte mm	Lengte mm	Prijs €
790002934	30	22	10	129	47,50
790002935	30	27	12	134	56,50
790002936	30	32	14	141	56,50
790002937	40	22	10	156	56,50
790002938	40	27	12	159	69,90
790002939	40	32	14	178	69,90

MACH



Gecombineerde vlakfrees houders DIN6358, dubbel gebruik langs en dwars, met konus MAS403 BT.

Troeven:

- De freeshouders zijn uitgebalanceerd tot 12.000 tpm
- Dubbel gebruik langs en dwars
- Concentriciteit en uitloop minder of gelijk aan 0.005 mm
- Oppervlakte hardheid HRC58-62
- Worden vervaardigd uit gecarboniseerd gelegerd staal

Geschikt voor:

- Voor het opnemen van vlakfreesen en mantelkopfreesen van alle gekende merken met een asgat van 16 tot 40 mm. Andere maten op aanvraag.
- De meeste CNC machines met een MAS-403 BT30 opname, uiteraard ook op onze F3, F4 en F80.

Tip: Vergeet uw aantrekbouten / pull studs niet bij te bestellen voor uw F3 / F4 / F80, 790003068

Order nr.	Orig. nr.	Opname	Lengte	D	Gewicht	Afmetingen (l x b x h)	Prijs €
			mm	mm	kg	mm	
790002975	CVH3116	BT30	55	16	1,00	60 x 40 x 40	65,90
790002989	CVH3116	BT30	55	22	1,30	60 x 45 x 45	68,50
790002990	CVH3122	BT30	55	27	1,50	60 x 50 x 50	71,90
790002991	CVH3127	BT30	55	32	1,80	60 x 60 x 60	75,50
790002992	CVH3132	BT30	60	40	2,20	70 x 65 x 65	79,90

MACH



BT



Uitgebalanceerde Weldon freeshouders MAS403 BT30 voor het opnemen van frezen met een weldon schacht DIN1835B.

Troeven:

- De freeshouders zijn uitgebalanceerd tot 12.000 tpm.
- Concentriciteit en uitloop minder of gelijk aan 0.005 mm
- Oppervlakte hardheid HRC58-62
- Worden vervaardigd uit gecarboniseerd gelegerd staal

Geschikt voor:

- De meeste CNC machines met een MAS-403 BT30 opname, uiteraard ook op onze F3 / F4 en F80.

Tip: Vergeet uw aantrekbouten / pull studs niet bij te bestellen voor uw F3 / F4 / F80, 790003068.

Order nr.	Orig. nr.	Opname	Lengte	D	D1	L2	Ge-afmetingen (l x b x h)	Prijs
		name	mm	mm	mm	mm	mm	€
790003029	M	BT30-50-6	BT30	98,4	25	31,75	18	0,66 70 x 70 x 160 60,90
790003030	M	BT30-60-8	BT30	108,4	28	31,75	18	0,80 70 x 70 x 160 60,90
790003031	M	BT30-60-10	BT30	108,4	35	31,75	20	0,83 70 x 70 x 160 60,90
790003032	M	BT30-60-12	BT30	108,4	42	31,75	22,5	0,88 70 x 70 x 160 60,90
790003033	M	BT30-60-14	BT30	108,4	44	31,75	22,5	1,02 70 x 70 x 160 72,90
790003034	M	BT30-75-16	BT30	123,4	48	31,75	24	1,04 70 x 70 x 160 64,90
790003035	M	BT30-75-18	BT30	123,4	50	31,75	24	1,26 70 x 70 x 180 72,90
790003036	M	BT30-75-20	BT30	123,4	52	31,75	25	1,38 70 x 70 x 180 65,90
790003037	M	BT30-90-25	BT30	138,4	65	31,75	24	1,50 70 x 70 x 200 74,50

MACH



Aantrekbout MAS403 BT30 / M12 - 45°

Geschikt voor:

- Het aantrekken van diverse gereedschapshouders MAS403 BT30 / M12.
- Te gebruiken bij F3 / F4 en F80.

Order nr.	790003068	M
Orig. nr.	PSBT3045	
Gewicht	kg	1,00
Prijs	€	12,50

MACH

Montageblok voor DIN69871, DIN2080 en MAS403.



Troeven:

- Vlwg, veilig en tijdsbesparend.
- Efficiënt aanspannen / lossen van uw gereedschap in uw houders.
- Met verticale als horizontale inzet.

Geschikt voor:

- Te gebruiken bij iedere CNC machine met de corresponderende spindelopname.
- ISO en SK hebben dezelfde opname

Order nr.	Opname	Konus	Gewicht	Afmetingen (l x b x h)	Prijs €	
			kg	mm		
790004499	M	MAS403	BT30	3,20	205 x 98.5 x 128	56,90
790004500	M	MAS403	BT40	3,80	205 x 98.5 x 128	68,50
790004501	M	MAS403	BT50	11,40	275 x 150 x 198	114,00
790004502	M	DIN69871	SK30	3,70	205 x 98.5 x 128	56,90
790004503	M	DIN69871	SK40	3,80	205 x 98.5 x 128	68,50
790004504	M	DIN69871	SK50	11,40	275 x 150 x 198	114,00

Opspangereedschap draaibank



Order nr.	Voor type	Voor draaibank	Vierkant beitels mm	Lengte mm	Prijs €
790007253	M A0/SWHAA	TU1503V	12	50	65,90
790007240	M A1/SWH1	TU2404-TU2406-TU2506-TU2807 D320-	20	90	71,90
790007243	M E5/SWH3	D330-D360 TH3309 TH3610 TH4010 D320-	20	100	91,50
790007314	M E5/SWH3	D330-D360 TH3309 TH3610 TH4010	25	100	92,50
790007246	M B2/SWH5	D420 TH46	25	120	79,90
790007247	M B2/SWH5	D420 TH46	32	140	137,00
790007250	M C3/SWH7	D560 TH56	32	150	156,00
790007251	M C3/SWH7	D560 TH56	40	170	208,00

40 posities snelwissel beitelhouder.

Troeven:

- Herhalingsnauwkeurigheid 0,01 mm
- 40 verschillende hoekinstellingen
- Hoogteafstelling d.m.v. kartelschroef
- Kop en houder met profielgeslepen vertanding
- Voor het spelvrij en nauwkeurig inspannen van de houder

Geschikt voor:

- Alle gangbare draaibanken

Geleverd met:

- 1 Snelwissel beitelhouderkop
- 3 Beitelhouders voor vierkante beitels type D
- 1 Beitelhouder voor ronde beitels type B

Tip: montage en/of aanpassing van de set is niet inbegrepen in de prijs. Dit zijn universele snelwissel beitelhouders, bij elke montage moet de originele beitelhouder v/d draaibank worden aangepast, zie 719000400. Dit bedrag is enkel geldig voor aankoop bij nieuwe draaibanken van Optimum.

Order nr.	Omschrijving mm	Voor type	Prijs €
790007234	M A0 / SWHAA	TU1503V-TU2004V	299,00
790007235	M A1 / SWHA1	TU2506-TU2807	436,00
790007236	M E5 / SWH3	TH3309 TH3610 TH4010	395,00
790007237	M B2 / SWH5	D420 TH46	595,00
790007238	M C3 / SWH7	D560 - TH56	809,00



Afzonderlijke extra beitelhouders voor vierkante beitels type D om uw set uit te breiden.

Geschikt voor:

- 40 positie snelwisselende beitelhouders MW Mach, Optimum

Tip: we hebben ook beitelhouders voor ronde beitels, boorstanghouders en morse konus houders verkrijgbaar.

Order nr.	Voor type	Voor draaibank	Vierkant beitels mm	Lengte mm	Prijs €
790007253	M A0/SWHAA	TU1503V	12	50	65,90
790007240	M A1/SWH1	TU2404-TU2406-TU2506-TU2807 D320-	20	90	71,90
790007243	M E5/SWH3	D330-D360 TH3309 TH3610 TH4010 D320-	20	100	91,50
790007314	M E5/SWH3	D330-D360 TH3309 TH3610 TH4010	25	100	92,50
790007246	M B2/SWH5	D420 TH46	25	120	79,90
790007247	M B2/SWH5	D420 TH46	32	140	137,00
790007250	M C3/SWH7	D560 TH56	32	150	156,00
790007251	M C3/SWH7	D560 TH56	40	170	208,00



Afzonderlijke extra beitelhouders voor ronde beitels type B om uw set uit te breiden.

Geschikt voor:

- 40 positie snelwisselende beitelhouders MW Mach, Optimum

Tip: we hebben ook beitelhouders voor vierkante beitels, boorstanghouders en morse konus houders verkrijgbaar.

Order nr.	Voor type	Voor draaibank	Ronde beitels mm	Lengte mm	Prijs €
790007254	M A0/SWHAA	TU1503V	12	50	65,90
790007241	M A1/SWH1	TU2404-TU2406-TU2506-TU2807 D320-	20	90	78,90
790007244	M E5/SWH3	D330-D360 TH3309-TH3310-TH4010	30	100	104,00
790007248	M B2/SWH5	D420-D460-TH46	32	130	115,00
790007252	M C3/SWH7	TH56	40	160	195,00

MACH



Afzonderlijke beitelhouders type S voor opname van boorstangen.

Geslacht voor:

- 40 positie snelwisselende beitelhouders MW Mach, Optimum

Tip: In combinatie met morse conus bussen kunnen zo morse conus boren worden opgenomen in de snelwissel beitelhouder.

Order nr.	Voor type	Voor draaibank	Boorstang mm	Lengte mm	Prijs €
790007255	M A0/SWHAA	TU1503V	15	50	85,50
790007256	M A1/SWH1	TU2404-TU2406-TU2506-TU2807	30	80	111,00
790007257	M A1/SWH1	TU2404-TU2406-TU2506-TU2807	20	90	111,00
790007258	M E5/SWH3	D330-D360 TH3309 TH3610 TH4010 D320-	30	100	131,00
790007259	M E5/SWH3	D330-D360 TH3309 TH3610 TH4010	40	100	134,00
790007260	M B2/SWH5	D420-D460-TH46	40	120	163,00
790007261	M C3/SWH7	D560-TH56	40	150	267,00
790007262	M C3/SWH7	D560-TH56	50	150	276,00

MACH



Afzonderlijke extra bussen type L voor opname van morse conus boren.

Geslacht voor:

- 40 positie snelwisselende beitelhouders MW Mach, Optimum

Tip: In combinatie met boorstanghouder type S kunnen zo morse conus boren worden opgenomen in de snelwissel beitelhouder.

Order nr.	Voor type	Voor draaibank	Boorstang mm	Lengte mm	Morse konus MK	Prijs €
790007263	M A1/SWH1	TU2404-TU2406-TU2506-TU2807	30	80	1	26,50
790007264	M A1/SWH1	TU2404-TU2406-TU2506-TU2807	30	90	2	26,90
790007265	M E5/SWH3	D330-D360 TH3309-TH3310-TH4010 D320-	30	100	2	26,90
790007266	M E5/SWH3	D330-D360 TH3309-TH3310-TH4010	40	114	3	29,50
790007267	M B2/SWH5	D420-D460-TH46	40	120	2	29,50
790007268	M B2/SWH5	D420-D460-TH46	40	120	3	29,50
790007269	M B2/SWH5	D420-D460-TH46	40	140	4	33,50
790007270	M C3/SWH7	D560-TH56	40	140	3	33,50
790007271	M C3/SWH7	D560-TH56	40	150	4	36,90
790007272	M C3/SWH7	D560-TH56	50	150	4	39,50

OPTIMUM



Afsteekbeitelhouderset AFB16

Troeven :

- Voor het afsteken van allerlei werkstukken op een draaibank.
- Met verschillende afsteekbreedtes 2,2 en 3,1 mm
- Voor het opspannen in vierkantshouders of snelwissel beitelhouders met opnamehoogte van 16 mm.

Geslacht voor :

Alle draaibanken met vierkantshouders of snelwissel beitelhouders met opnamehoogte van 16mm.

Geleverd met :

- 1 x Afsteekbeitelhouder SLTBN 16-05
- 1 x Afsteekbeitelmes SLIH 26-2
- 1 x Afsteekbeitelmes SLIH 26-3
- 5 x Afsteekplaatjes GTN2 (afsteekbreedte 2,2 mm)
- 5 x Afsteekplaatjes GTN3 (afsteekbreedte 3,1 mm)
- Aluminium opbergkoffer

Order nr.	713440653	M
Orig. nr.	AFB16	
Afsteekbreedte	mm	2,2 / 3,1
Voor	D320-D330-D360 TH3309-TH3310-TH4010	
Gewicht	kg	3,00
Prijs	€	156,00

OPTIMUM



Afsteekbeitelhouderset AFB20

Troeven :

- Voor het afsteken van allerlei werkstukken op een draaibank.
- Met verschillende afsteekbreedtes 3,1 en 4,1 mm
- Voor het opspannen in vierkantshouders of snelwissel beitelhouders met opnamehoogte van 20 mm.

Geslacht voor :

• Alle draaibanken met vierkantshouders of snelwissel beitelhouders met opnamehoogte van 20 mm.

Geleverd met :

- 1 x Afsteekbeitelhouder SLTBN 20-05
- 1 x Afsteekbeitelmes SLIH 26-3
- 1 x Afsteekbeitelmes SLIH 26-4
- 5 x Afsteekplaatjes GTN3 (afsteekbreedte 3,1 mm)
- 5 x Afsteekplaatjes GTN4 (afsteekbreedte 4,1 mm)
- Aluminium opbergkoffer

Order nr.	713440654	M
Orig. nr.	AFB20	
Afsteekbreedte	mm	3,1 / 4,1
Voor	D420-D460-TH46-TH56	
Gewicht	kg	4,00
Prijs	€	167,00

OPTIMUM



Afsteekbeitelhouderset AFB25

Troeven :

- Voor het afsteken van allerlei werkstukken op een draaibank.
- Met verschillende afsteekbreedtes 3,1 en 4,1 mm
- Voor het opspannen in vierkantschouwers of snelwissel beitelhouders met opnamehoogte van 25 mm.

Geschikt voor :

- Alle draaibanken met vierkantschouwers of snelwissel beitelhouders met opnamehoogte van 25 mm.

Geleverd met :

- 1 x Afsteekbeitelhouder SLTBN 25-05
- 1 x Afsteekbeitelmes SLIH 26-3
- 1 x Afsteekbeitelmes SLIH 26-4
- 5 x Afsteekplaatjes GTN3 (afsteekbreedte 3,1 mm)
- 5 x Afsteekplaatjes GTN4 (afsteekbreedte 4,1 mm)
- Aluminium opbergkoffer

Order nr.	713440655 M		
Afsteekbreedte	mm	3,1 / 4,1	
Voor		D660 TU8020 TU8030	
Gewicht	kg	5,00	
Prijs	€	178,00	

MACH



Precisie meedraaiend kopieercenterpunt 60° (met verlengde punt).

Troeven:

- Om eenvoudiger bij moeilijker te hanteren werkstukken te komen.
- Werkplaatskwaliteit.
- MK1 gewoon meedraaiend centerpunt verkort TU1503V.

Order nr.	Aansluiting MK	Lengte mm	Voor type	Prijs €
713440700 M	1 (korte schacht)		TU1503V	58,90
790007216 M	2	141	TU2004-TU2304-TU2406 TU2056-TU2807	34,90
790004697 M	3	168	TU3008-D320-D330-D360 TH3309-TH3310	43,90
790004698 M	4	190	D420-D460-TH46	48,50
790007214 M	5	267,5	D560-TH56-D660 TU8020-TU8030	104,00

OPTIMUM

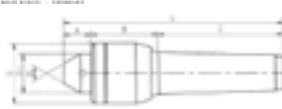

Set met 1 meedraaiend centerpunt met 7 verwisselbare punten.

Troeven:

- Precizie-naaldrollagers garanderen een hoge nauwkeurigheid.
- Lichaam van gehard en geslepen gereedschapsstaal.

Geleverd met:

- Meedraaiend centerpunt
- 7 verwisselbare punten
- in een koffer.

Order nr.	713440732 M	713440733 M	713440734 M	
Aansluiting	MK	2	3	4
A	mm	22	23	23
B	mm	36	44	51
C	mm	69	86	108
D	mm	32	41	47
D1	mm	25	30	32
Nauwkeurigheid	mm	0,008	0,008	0,008
Maximum snelheid	tpm	4000	3000	2500
Prijs	€	195,00	229,00	230,00

OPTIMUM



Spantangenklauwplaat ER passend op draaibanken zoals Optimum.

Troeven:

- Werkt met ER spantangen DIN6499
- Met ofwel kortkegel opname ofwel cilindrische opname.

Geschikt voor:

- kleine conventionele draaibanken met dezelfde spindel

Order nr.	Voor type	Aansluiting ER spantang	Prijs €
713440281 M	TU1503V	Kortkegel ER16	65,50
713441305 M	TU2506 / TU2807	Kortkegel ER25	104,00
713440305 M	TU2004V	Cilindrisch ER25	83,90
713440505 M	TU2404 TU2406 TU2304	Cilindrisch ER25	92,90
713441306 M	TU2506 TU2807	Kortkegel ER32	126,00
713440506 M	TU2404 TU2406	Cilindrisch ER32	104,00

OPTIMUM

Spantangenklauwplaat 5C met Camlock aansluiting.



Geschikt voor:

- Passend op draaibanken zoals Optimum.

Troeven:

- Met opname Camlock DIN55029 (DIN ISO 702:2).
- Rondloopenauwkeurigheid 0.02 mm.

Tip: 5C spantangen niet inbegrepen zie 713441509.

Order nr.	713441554 M	713441556 M	713441558 M	
Aansluiting	D1-4"	D1-6"	D1-8"	
Voor type	D320 TH3309	D420 TH46	TH4615V TH56	
Prijs	€	659,00	729,00	775,00

HOE EEN GESCHIKTE KLAUWPLAAT KIEZEN VOOR UW DRAAIBANK?

Eerst en vooral dient u te weten wat de spilconus van uw draaibank is, vooraal u een keuze kunt maken uit een drieklaw of een vierklaw.

Wij hebben in ons gamma 2 types:

1. Klauwplaten DIN6350 kunnen enkel worden gemonteerd in combinatie met een flens. Dus zonder geschikte flens kan u deze klauwplaten niet monteren op uw draaibank. De klauwplaten DIN6350 zelf zijn eenvoudig te kiezen, de flenzen daarentegen vereisen enige kennis. We hebben getracht dit zo eenvoudig mogelijk op te lossen door onze modellen van draaibanken naast de specifieke flenzen te plaatsen.

2. Onze klauwplaten DIN55029 of het welgekende Camlock systeem hebben een rechtstreekse koppeling, klauwplaat en flens zijn één geheel. Dit heeft als voordeel dat u veel dichter bij de kop van uw draaibank werkt en dus veel stabielere kunt werken en bovendien geen extra flens dient aan te schaffen.

Drieklaw of vierklaw?

Een drieklaw wordt gebruikt om ronde of driehoekige materialen op te spannen. Onze drieklawen zijn manueel en zelfcenterend, de werking van de klauwen wordt geactiveerd door gebruik te maken van de meegeleverde T sleutel in één van de toegangsgaten te plaatsen op de buitendiameter van de klauwplaat. Wanneer de T-sleutel in wijzerzin wordt gedraaid, wordt een spiraal en rondsel in werking gebracht, die op hun beurt de klauwen gelijktijdig met precies dezelfde beweging naar het center verplaatsen. Als de T-sleutel in tegen wijzerzin wordt gedraaid dan verplaatsen de klauwen zich naar de buitenzijde van de klauwplaat. Onze drieklawen worden voorzien van een stel inwendige en uitwendige klauwen. Het grootste voordeel van een vierklaw is dat er ook vierkante materialen kunnen worden opgespannen. Onze vierklawen zijn ofwel zelfcenterend zoals de werking van onze drieklaw ofwel onafhankelijk verstelbaar, iedere klaw kan afzonderlijk versteld worden, de klauwen worden niet gelijktijdig geactiveerd. Dus als u afwijkende vormen of excentrisch wenst te draaien, is de onafhankelijke vierklaw de ideale oplossing.

 **KLAUWPLATEN
OP VYNCKIER.BIZ**



Taphouders

OPTIMUM



Tapapparaat met omkeerinrichting.

Troeven:

- Een dubbel veermechanisme voor de automatische voeding en slipkoppeling, ter preventie van het breken van tappen.
- Werkt met standaard machinetappen.

Geschikt voor:

- Zowel boor- als freesmachines.

Geleverd met

- 2 rubberen flexibele spantangen Rubberflex
- Stang met aanslag
- Tapapparaten met MT in vermelding worden geleverd met kegeldoorn.

Tip: TALR512B16 zonder kegeldoorn. Om de gewenste kegeldoorn voor uw machine met B16 te vinden zie index. Rubberen flexibele spantangen voor tapapparaat zijn afzonderlijk verkrijgbaar.

Order nr.	713352042 M	790007220 M	790007221 M
Orig. nr.	TALR512B16	TALR820MT3	TALR820MT4
Capaciteit	M5-M12	M8-M20	M8-M20
Aansluiting	B16	MK3	MK4
Prijs	€ 460,00	535,00	535,00

MACH



Tapapparaat voor tapkoppen. Tappen met uw boormachine? Dan kan!

Troeven:

- Tapapparaat met morse konus opname, werkt met tappotten.
- Tappotten niet inbegrepen.

Geschikt voor:

- Boormachines uitgerust met een tapfunctie en boormachines met links-rechts draaiend.

Tip: Met de adaptor 790004476 kunt u het tapapparaat 790024020 van M3 tot M24 tappotten gebruiken. Met de adaptor 790004477, kunt u het tapapparaat 790024022 van M6 tot M40 tappotten gebruiken.

Order nr.	790024018 M	790024020 M	790024022 M
Orig. nr.	TA1MK2	TA2MK3	TA3MK4
Capaciteit	M	M3-M12	M6-M40
Aansluiting			
Prijs	€ 66,50	155,00	310,00

MACH



Tappot - snelwissel adaptor met slipkoppeling.

Geschikt voor:

- Gebruik van tappen DIN371 en DIN376. Tap wordt vastgeklikt rond de schacht.

Kenmerken:

- Serie 19 en 31mm.

Tappotten worden altijd gekozen volgens de diameter van de schacht en de vierkant aansluiting. Tap zelf niet inbegrepen.

Order nr.	Orig. nr.	Aansluiting	Geschikt voor tap	Diameter tap	Schacht vierkant	Prijs
	ϕ D1	ϕ D1	ϕ D1	ϕ D	mm	€
790004162 M	TKM1930	19	DIN371 M3	3.5	2.7	41,90
790004164 M	TKM1940	19	DIN371 M4	4.5	3.4	41,90
790004166 M	TKM1950	19	DIN371 M5-M6	6	4.3	41,90
790004167 M	TKM1960	19	DIN371 M6	6	4.9	41,90
790004168 M	TKM1980	19	DIN371 M8	8	6.2	41,90
790004169 M	TKM19100	19	DIN371 M10	10	8	41,90
790004170 M	TKM3150	31	DIN371 M5-M6	6	4.3	59,50
790004172 M	TKM3180	31	DIN371 M8	8	6.2	59,50
790004173 M	TKM31100	31	DIN371 M10	10	8	59,50
790004180 M	TKM19801	19	DIN376 M8	6	4.9	41,90
790004181 M	TKM191001	19	DIN376 M10	7	5.5	41,90
790004182 M	TKM19120	19	DIN376 M12	9	7	41,90
790004185 M	TKM31801	31	DIN376 M8	6	4.9	59,50
790004186 M	TKM311001	31	DIN376 M10	7	5.5	59,50
790004187 M	TKM31120	31	DIN376 M12	9	7	59,50
790004188 M	TKM31140	31	DIN376 M14	11	9	59,50
790004189 M	TKM31160	31	DIN376 M16	12	9	59,50
790004190 M	TKM31180	31	DIN376 M18	14	11	59,50
790004191 M	TKM31200	31	DIN376 M20	16	12	59,50
790004192 M	TKM31220	31	DIN376 M22	18	14.5	59,50
790004193 M	TKM31240	31	DIN376 M24	18	14.5	59,50

MACH

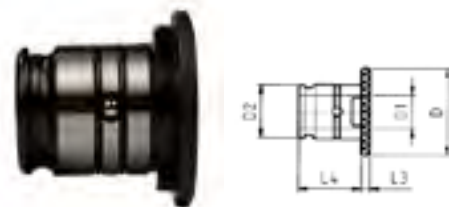

Adapter voor tappotten TA.

Troeven:

- U kunt als de aansluiting van uw tappotten te groot is een reductieadapter gebruiken.
- Zo kunt u als u een kleinere maat wenst te gebruiken, deze adapter aanschaffen.

Tappotten met een diameter van 48, kunt u reduceren naar diameter 31

Tappotten met een diameter van 31, kunt u reduceren naar diameter 19

Order nr.	790004476 M	790004477 M
Aansluiting	ϕ D1	31 - 19
Prijs	€ 75,00	81,50

MACHINES

Bankschroeven



Stalen bankschroef. Onbreekbaar.

Kenmerken:

- Industriële kwaliteit.
- Uit onbreekbaar ductiel gietijzer 500/7.
- Met 360° draaibare basis, gehard aambeeld en pijpbecken.
- Zwarte warmverlakte afwerking.

Order nr.	Orig. nr.	Bekbreedte mm	Klemwijdte mm	Gewicht kg	Prijs €
909070750	BAGSY3	75	85	14,40	59,50
909071000	BAGSY4	100	110	15,00	65,50
909071250	BAGSY5	125	135	11,00	85,50
909071500	BAGSY6	150	160	14,50	105,00
909072000	BAGSY8	200	210	21,50	149,00
909072500	BAGSY10	250	260	25,60	229,00



Professionele stalen bankschroef.

Kenmerken:

- Onbreekbaar, uit onbreekbaar ductiel gietijzer.
- Industriële kwaliteit.
- 500/7.
- Met 360° draaibare basis, gehard aambeeld en pijpbecken.
- Met schroeven om de geleiding aan te passen.

Order nr.	Orig. nr.	Bekbreedte mm	Klemwijdte mm	Diameter pijpbecken mm	Gewicht kg	Prijs €
909061000	BAP100	100	110	13	16,60	72,50
909061250	BAP125	125	135	16	12,40	99,50
909061500	BAP150	150	160	16	18,40	129,00
909061750	BAP175	175	185	16	27,40	179,00



Set zachte aluminium klauwen.

Kenmerken:

- Met magnetische strip voor het vasthechten op becken.

Geslacht voor:

- Elke klassieke bankschroef.

Order nr.	909079100	909079150
Orig. nr.	MGNALU100	MGNALU150
Lengte	100mm	150mm
Gewicht	kg 0,21	0,21
Prijs	€ 7,70	9,60

Boorklemmen



	MMSO 75	MMSO 100	MMSO 125	MMSO 150
A	113,0	113,0	113,0	146,0
B	85	100	110	130
C	50	74	85	100
D	30	40	45	50
E	120	150	180	220
F	270	300	400	450
G	75	100	120	150
H	100	130	150	170
I	130	150	170	200
J	20	20	20	20

Universele boorklem met vaste prismabek.

Troeven:

- Werkplaatskwaliteit.
- Vlotte werking
- Exacte bekeleiding, ook bij axiale belasting
- Biedt veel montage mogelijkheden op de boortafel door ovale gaten.

Geslacht voor:

- Tafel en kolomboormachines, bvb Optimum B-serie.

Order nr.	Orig. nr.	Bekbreedte mm	Bekhoogte mm	Klemwijdte mm	Breedte I mm	Diepte E mm	Prijs €
713000075	MMSO75	75	28	55	130	126	26,50
713000100	MMSO100	100	28	90	165	165	30,50
713000125	MMSO125	125	30	110	182	186	36,90
713000150	MMSO150	150	35	130	208	222	40,90



Universele boorklem met vaste prismabek.

Troeven:

- Professionele kwaliteit
- Vlotte werking
- Gerolde trapezoidale spindel
- Exacte bekeleiding, ook bij axiale belasting
- Biedt veel montage mogelijkheden op de boortafel door meerdere ovale gaten, als zijdelingse inkepingen

Geslacht voor:

- Tafel en kolomboormachines, bvb Optimum B**Pro-serie.

Order nr.	Orig. nr.	Bekbreedte mm	Bekhoogte mm	Klemwijdte mm	Breedte K mm	Diepte G mm	Prijs €
713000008	BMS85	85	27	70	130	152	46,90
713000010	BMS100	100	30	90	150	170	64,90
713000012	BMS120	120	35	110	170	193	80,90
713000015	BMS150	150	45	130	200	228	97,90
713000020	BMS200	200	60	160	252	262	124,00

HOE EEN GESCHIKTE BOORKLEM KIEZEN VOOR UW BOORMACHINE?

U meet de tafelafmeting van uw boormachine in breedte en diepte op in mm, vervolgens kiest u een boorklem die het beste bij u past en vergelijkt u de breedte en diepte van de boorklem. Komt de boorklem te ver uit uw boortafel dan is deze te groot en niet geschikt voor uw boormachine. Hou ook rekening met de T-gleuven in de tafel en de gleuven in de boorklem. Vergeet bij het bestellen van uw boorklem uw T-moeren niet bij te bestellen.

OPTIMUM

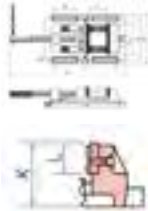

Krachtige boorklem van industriekwaliteit.

Troeven:

- Met verwisselbare prismabekken (vaste en beweegbare bek).
- Veel montage mogelijkheden op de boortafel door langwerpige sleufgaten.
- Prismabekken precisiegeslepen.
- Hoogwaardig gietijzer.
- Geschaafde geleidingsvlakken

Geschikt voor:

- Tafel en kolomboormachines, bvb Optimum B**H - serie.

Tip: Hoe steviger en langer de geleiding van de beweegbare bek wordt geleid, hoe minder kans dat uw werkstuk wordt gelift.

Order nr.	713000210 ^M	713000214 ^M	713000220 ^M
Orig. nr.	BSI100	BSI140	BSI200
Bekbreedte mm	100	140	200
Bekhoogte mm	40	50	64
Klemwijdte mm	110	150	210
Breedte H mm	170	230	290
Diepte J mm	216	290	406
Totale hoogte mm	72	90	114
Prijs	€ 126,00	206,00	299,00

OPTIMUM

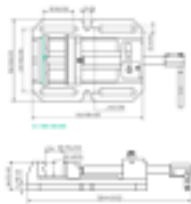

Boorklem met snelspan systeem van industriële kwaliteit.

Troeven:

- Exacte bekkengeleiding, ook bij axiale last.
- Spindel met gerolde trapeziumdraad.
- Met prismabek op de vaste bek, precisie geslepen.
- Veel montage mogelijkheden op de boortafel door langwerpige sleufgaten.
- Hoogwaardig gietijzer.
- Geschaafde geleidingsvlakken bieden een soepele bediening.

Geschikt voor:

- Tafel en kolomboormachines, bvb Optimum DH** serie.

Order nr.	713000230 ^M	713000234 ^M	713000240 ^M
Orig. nr.	BSI-Q100	BSI-Q140	BSI-Q200
Bekbreedte mm	100	140	200
Klemwijdte mm	105	155	220
Gewicht kg	8,00	17,00	38,00
Prijs	€ 153,00	264,00	321,00

MACH



Zwaargebouwde zelfcenterende mechanische machineklem met draaibasis tot 90°, van hoogwaardig gietstaal.

Kenmerken:

- Geharde en geslepen geleidingen.
- Spanbekken zijn gehard, geslepen en uitwisselbaar.
- Groot spanbereik.

Geschikt voor:

- Gebruik op boorfreesmachines en slijpmachines.

Order nr.	713354217 ^M
Orig. nr.	MVC160
Bekbreedte mm	160
Bekhoogte mm	45
Klemwijdte mm	160
Totale lengte mm	486
Totale hoogte mm	155
Totale breedte mm	190
Prijs	€ 299,00

OPTIMUM

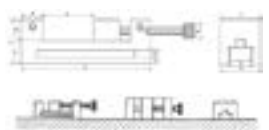

Machineklem nauwkeurig.

Geschikt voor:

- Gebruik op boorfreesmachines en slijpmachines.

Kenmerken:

- Schroefmodel.
- Uitgerust met prismabek.



Kan zowel horizontaal als verticaal gebruikt worden in een andere machineklem of op de tafel door gebruik te maken van een aandrukker langs de zijanten van de machineklem.

Order nr.	790007203 ^M
Orig. nr.	MSN80
Bekbreedte mm	80
Bekhoogte mm	40
Klemwijdte mm	100
Breedte mm	80
Diepte mm	220
Prijs	€ 137,00

MACHINES

Freesklemmen

OPTIMUM

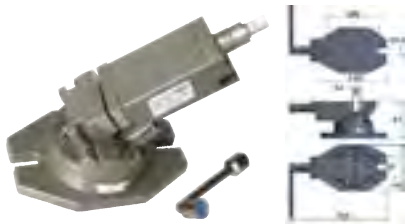

Twee-assige mechanische freesklem.

Troeven:

- Verticaal als horizontaal kantelbaar tot 90°.
- 360° draaibaar op draaitafel.
- Geharde en geslepen bekken.
- Afleeschalen op beide assen.

Geslacht voor:

- het positioneren van uw werkstuk onder een bepaalde hoek, wanneer u met een horizontale tafel werkt
- Thuiswerker en doe-het-zelver

Order nr.	713354170	
Orig. nr.	ZAS50	
Bekbreedte	mm	50
Bekhoogte	mm	22
Klemwijdte	mm	46
Totale lengte	mm	205
Totale hoogte	mm	87
Prijs	€	148,00

OPTIMUM



	A	B	C	D	E	F	G	H	I	J	K
MV3-75	mm	185	150	85	138	85	14	158	105	15,5	11
MV3-125	mm	242	204	95	185	95	45	200	200	12,5	28

Drie-assige mecahnische freesklem.

Troeven

- Uit hoogwaardig gietijzer.
- Verticaal als horizontaal kantelbaar tot 90°.
- 360° draaibaar op draaitafel en +/-45° verticale zwenkbeweging over de spindel.
- Geharde en geslepen bekken.
- Afleeschalen op alle 3 assen.

Geslacht voor:

- het positioneren van uw werkstuk onder een bepaalde hoek, wanneer u met een horizontale tafel werkt

Order nr.	713354175	713354178	
Orig. nr.	MV3-75	MV3-125	
Bekbreedte	mm	75	125
Bekhoogte	mm	33	45
Klemwijdte	mm	82	97
Totale hoogte	mm	150	206
Prijs	€	276,00	345,00



MACH



Universeel inzetbare prismabek voor allerlei machineklemmen.

Kenmerken:

- Uitgerust met een werkstukaanslag.

U plaats de prismabek eenvoudig over uw bestaande bek en spant door middel van vijzen de prismabek aan.

Order nr.	Orig. nr.	Bekbreedte mm	Prijs €
790000111	UPB110	100 - 110	90,50
790000112	UPB140	125 - 140	97,90
790000113	UPB160	150 - 160	105,00
790000114	UBP210	200 - 210	125,00

OPTIMUM



	A	B	C	D	E	F	G	H	I	J	K	L
FMS 100	mm	75	110	114	100	80	30	105	100	270	180	110
FMS 125	mm	33	120	145	120	80	33	120	110	310	180	120
FMS 150	mm	33	210	180	165	114	40	140	140	410	180	110
FMS 200	mm	95,5	295	250	215	150	50	170	170	510	180	200

Mechanische precisie freesklem.

Troeven:

- Robuust gebouwd.
- Machineklem is uit hoogwaardig gietijzeren vervaardigd.
- De geleidingsvlakken zijn gehard en geslepen.
- Uitwisselbare geharde en geslepen bekken.
- Met draaivoet, 360° verdraaibaar. (demonteerbaar)

Geslacht voor:

- Boorfreesmachines en freesmachines

Tip: prismabek optioneel verkrijgbaar

Order nr.	Orig. nr.	Bekbreedte mm	Bekhoogte mm	Klemwijdte mm	Totale lengte mm	Prijs €
713354100	FMS100	100	30	62	295	160,00
713354125	FMS125	125	37	85	370	218,00
713354150	FMS150	150	40	114	462	252,00
713354200	FMS200	200	58	150	620	425,00

OPTIMUM



	A	B	C	D	E	F	G	H	I	J	K
IMSN 100 mm	230	14,5	101	36	240	110	135	100	100	114	10
IMSN 125 mm	240	16,5	105	36	270	110	135	105	105	115	10
IMSN 150 mm	280	18,5	114	44	320	140	145	105	110	118	10

Mechanische precisie freesklem.

Troeven:

- Neertrekmechanica voor het zekerder spannen van het werkstuk.
- Machineklem is uit hoogwaardig gietijzeren vervaardigd.
- De geleidingsvlakken zijn gehard en geslepen.
- Uitwisselbare geharde en geslepen bekken.
- Afgeschermd spindel
- Door het omwisselen van de bekken ook naar buiten spanned.
- Met draaivoet, 360° verdraaibaar.(demonteerbaar)

Geschied voor:

- Boorfreesmachines en freesmachines

Tip: prismabek optioneel verkrijgbaar

Order nr.	Orig. nr.	Bek-breedte mm	Bek-hoogte mm	Klem-wijdte mm	Totale lengte mm	Prijs €
713354110	FMSN100	100	31	101	325	310,00
713354120	FMSN125	135	33	108	369	339,00
713354130	FMSN150	150	46	146	425	379,00

OPTIMUM

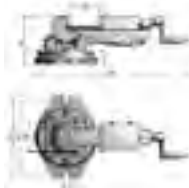

Drie-assige mecahnische freesklem.

Kenmerken:

- Uit hoogwaardig gietijzer.
- Verticaal als horizontaal kantelbaar tot 90°.
- 360° draaibaar op draaitafel en +/-45° verticale zwenkbeweging over de spindel.
- Geharde en geslepen bekken.
- Afleeschalen op alle 3 assen.
- Industriekwaliteit.
- Prismabekken verkrijgbaar met ordernr. 713355502.

Order nr.	713355500	
Orig. nr.	DAS100	
Bekbreedte	mm	100
Bekhoogte	mm	38
Klemwijdte	mm	105
Totale hoogte	mm	172
Totale lengte	mm	631
Prijs	€	509,00

OPTIMUM

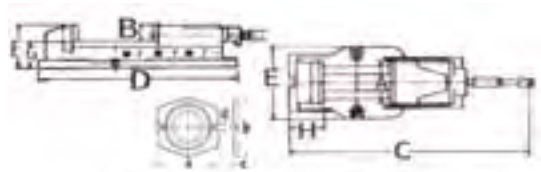

	A	B	C	D	E	F	G	H	I	J	K	L	M
HMS 100 mm	100	36	121	40	100	110	110	100	100	110	10	10	10
HMS 125 mm	127	46	121	40	110	110	110	110	110	110	10	10	10
HMS 150 mm	150	51	121	40	110	110	110	110	110	110	10	10	10
HMS 200 mm	200	65	121	40	110	110	110	110	110	110	10	10	10

Hydraulische precisie freesklem voor een trefzeker spannen van het werkstuk.

Troeven:

- Met geharde en geslepen uitwisselbare bekken.
- Dankzij het Booster-systeem wordt een hoge klemspanning bereikt met weinig kracht.
- Op 360° draaibare basis (kan gedemonteerd worden).
- Beschermd draaispil.
- Groot klembereik door spanbouten met vaste gaten
- Vervaardigd uit hoogwaardig gietstaal.

Geschied voor:

Freesmachines, heavy duty boormachines en slijpmachines

Tip: prismabek optioneel verkrijgbaar

Order nr.	713355100	713355127	713355150	713355200
Orig. nr.	HMS100	HMS125	HMS150	HMS200
Bekbreedte	mm	100	127	150
Bekhoogte	mm	36	46	51
Klemwijdte	mm	0-60;57-115;110-170	0-80;78-115;140-208	0-100;98-200;195-300
Totale lengte	mm	525	670	800
Prijs	€	619,00	649,00	1.175,00

MACHINES

Kruistafels



Kruistafel voor kolomboormachines.

Kenmerken:

- Gietijzeren constructie.
- Budgetvriendelijk

Geschikt voor:

- Semi-professioneel gebruik, doe-het-zelver.

Order nr.	101075145	151575145
Bekbreedte	mm 100	150
Klemwijdte	mm 95	150
Dwarskoers	mm 100/150	150/200
Centerafstand bevestigingsgaten	mm 125	160
Prijs	€ 56,90	79,90



Professionele kruistafel voor individuele montage op bestaande machines.

Kenmerken:

- Met een opvangruimte voor de koelmelk.
- Reduceerbare speling dankzij de zwaluwstaartconstructie.
- Verplaatsing van de tafel dmv een handwiel met schaalverdeling 0.05mm.

Opmerking: Dit is een universele kruistafel. Dit betekent dat in sommige gevallen een aanpassing en/of tussenstuk zal nodig zijn om de kruistafel met de montagetafel te verbinden. Deze aanpassing is leverbaar tegen meerprijs. Hiervoor onze technische dienst raadplegen.

Order nr.	Koers X/Y	A (voet-D breedte)	(voet-C lengte)	(tafel-E lengte)	(tafel-F breedte)	G (T-gleuven grootte)	Prijs
	mm	mm	mm	mm	mm	mm	€
713356595	220x165	222	280	400	120	10	460,00
713356596	280x175	274	340	500	180	12	635,00
713356591	480x175	274	340	700	180	12	775,00
713356600	480x210	280	362	730	210	14	925,00

Tafelklemming

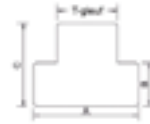

T-moeren voor spanklemmen.

Geschikt voor:

- Gebruik op boor- en freestafels met T-gleuven.

Kenmerken:

- HRC 34°.
- Warmte behandelde en zwart geoxideerde stalen uitvoering.

Geleverd per stuk.

Order nr.	Maat	Grootte T-gleuf	A	B	C	Prijs
	mm	mm	mm	mm	mm	€
713353020	M8	10	16	6	12	3,90
713353022	M10	12	18	7	14	4,50
713353024	M125	15,7	22	8	16	4,70
713353025	M12	14	25	8	16	4,60
713353026	M14	16	25	8	16	4,60
713353028	M16	18	28	11	20	4,60



Set complete spanbouten.

Geschikt voor:

- Ideaal om uw machineklem vast te maken aan uw boor-/freestafel, kruistafel.

Bestaat uit:

- 4 flensmoeren
- 2 draadstiften 75 mm (100 mm voor M16)
- 2 draadstiften 125 mm (150 mm voor M16)
- 4 T-moeren

Om een machineklem degelijk op te spannen hebt u minstens twee complete spanbouten nodig.

Prijs per set.

Order nr.	790007315	790007317	790007319
Grootte T-gleuf	mm 12	14	18
Maat	M10	M12	M16
Aantal stuks in set	12	12	12
Prijs	€ 21,50	24,50	34,90

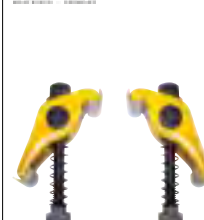

Aandrukkers.

Kenmerken:

- Beide uiteinden van de aandrukker zijn voorzien van een messing beschermplaatje.
- De gesmede klembeugel is verstelbaar in de hoogte.
- Materiaal S45C.

Geleverd per paar.

Order nr.	713352031	713352032
Voor T-gleuven	14	18
Aantrekdraad	M12	M16
Hoogte	mm 0-89	0-101
Prijs	€ 71,50	96,90

OPTIMUM

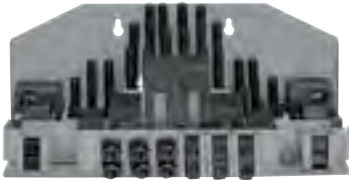

58 delig assortiment opspangereedschap.

Kenmerken:

- Metrische draad.
- Zwart geanodiseerde uitvoering.

Bestaande uit:

- 24 aantrekbouten (75, 125, 150, 175 en 200mm)
- 6 stuks T-sleufblokken
- 6 moeren
- 4 verlengingsmoeren
- 6 spanstempels
- 6 spanblokken

Geleverd met praktische muurhouder.

Order nr.	Voor T-gleuven mm	Binnendraad M	Voor type	Prijs €
713352015	10	M8	BF16	66,50
713352016	12	M10	BF20-BF20L-BF30-F40E	79,90
713352017	14	M12	UF100	91,50
713352018	16	M14	F30-F45-MF2-MF4	114,00
713352019	18	M16	BF46 Vario	125,00

Magneetplaten

MACH



Permanente magnetische opspanplaat of ook gewoonweg magneet of trekstaal genoemd.

Geschikt voor:

- Slijpmachines, freesmachines en CNC machines, deze laatste afhankelijk van vermogen en degelijke opspanning.

Kenmerken:

- Deze magneten hebben een aantrekking op ijzeren voorwerpen.
- Fijne polariteit, want hoe dichter de polen hoe groter de aantrekkingskracht.
- Trekkraft van 100 N/cm².
- Magneet wordt eenvoudig geactiveerd door de bijgeleverde hendel over te draaien.

Order nr.	H	T	Polariteit	Magneet-capaciteit N/cm ²	Afmetingen magneetvoet (l x b) mm	Prijs €
790001091	48	20	1+3	120	300x150	272,00
790001092	48	20	1+3	120	350x150	386,00
790001093	53	20	1+3	120	450x150	459,00
790001094	53	22	1+3	120	400x200	655,00

Draaitafels

OPTIMUM



Precisie draaitafel

Troeven:

- Kan zowel horizontaal als verticaal gebruikt worden
- Zeer nauwkeurige tafel ook onder belasting.
- Met precisie lagers uitgevoerd.
- Grote spilboring voor het opspannen van langere werkstukken.
- Snelindeling voor grotere series.
- Geharde en geslepen worm.
- Verhouding 90:1.
- Schaalverdeling op de werktafel van 360°.
- 1 handwiel-omwenteling geeft een verplaatsing van 4°.
- gemaakt uit een hoogwaardig Meehanite gietijzer

Tip: klauwplaten 3 bekken, opnameflensen, verdeelschijven en verstelbare tegenpunten zijn optioneel leverbaar.

Order nr.	Orig. nr.	Tafel- diameter (D)	Bouw- meter te (H)	Center- hoogte (H1)	T-gleuf (E)	Belas- ting (kg)	Belas- ting (verti- zontaal) caal)	Cen- ting ter- gat	Prijs €
713356110	RT100	110	72	80	11	35	18	MK2	321,00
713356150	RT150	150	80	102	11	40	20	MK2	310,00
713356200	RT200	200	102	135	14	80	40	MK3	494,00
790000004	RT250	250	109	163	14	90	50	MK3	749,00
790000005	RT300	300	125	194	16	120	60	MK4	829,00

OPTIMUM

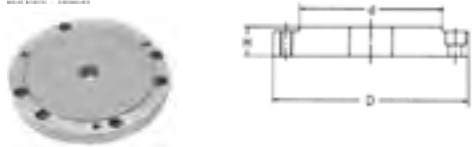

Opnameflens.

Troeven:

- Stalen flens
- Eénzijdig machinaal bewerkt
- Met voorgeboorde gaten op 120° / 90°

Geschikt voor:

- het bevestigen van klauwplaten 3 bekken op draaitafels RT.

Order nr.	Omschrijving	D mm	H mm	Prijs €
790007305	Opnameflens voor RT100	-	-	84,90
713356154	Opnameflens voor RT150	110	20	103,00
713356254	Opnameflens voor RT200	138	20	116,00
790000013	Opnameflens voor RT250	170	21	129,00
790000014	Opnameflens voor RT300	195	24	146,00

MACHINES

OPTIMUM



Klawuplatten 3 klauwen voor draaitafels.

Troeven:

- Gietijzeren uitvoering
- 3 klauwen sluiten concentrisch

Geschikt voor:

- te gebruiken op draaitafels

Geleverd met:

- Set 3 inwendige klauwen
- Set 3 uitwendige klauwen
- Klawuplattsleutel

Order nr.	Voor	Dia- me- ter	Buiten- dia- me- ter	Bin- nendi- ame- ter	D2	D1	D3	L	L1	H	Prijs
		mm	mm	mm	mm	mm	mm	mm	mm	mm	€
790007306	RT100	100	2 - 90	30 - 80	72	84	22	74,5	55	3,5	247,00
713356100	RT150	130	3 - 130	40 - 120	100	115	33	78	55	3,5	309,00
713356225	RT200	160	3 - 60	55 - 145	130	142	40	95	65	5	339,00
790007307	RT250	190	4 - 190	65 - 190	155	172	55	105	75	5	377,00
790007308	RT300	200	4 - 200	65 - 200	165	180	70	709	75	5	388,00

OPTIMUM



Verdeelschijven voor draaitafels

Geleverd met:

- Verdeelschijven 2 of 3 met verschillende gatenverdelingen
- Sectorarm
- Hoekklem
- O-ring en 3 vijzen
- Handzwenkel

Verdeelschijf gatenverdeling:

- A: 15, 16, 17, 18, 19, 20
- B: 21, 23, 27, 29, 31, 33
- C: 37, 39, 41, 43, 47, 49
- D: 28, 30, 34, 38, 41, 44, 47, 51, 57, 38, 32, 37, 39, 43, 45, 49, 53, 59
- E: 61, 67, 71, 77, 81, 87, 91, 97, 63, 69, 73, 79, 83, 89, 93, 99

Order nr.	Omschrijving	Prijs
		€
713356152	voor RT150 RT150 - 3 schijven A, B en C	129,00
713356205	voor RT200, RTU165 - 2 verdeelschijven D, E	161,00
790000021	voor RT250 RT300 - 2 verdeelschijven D, E	202,00

OPTIMUM



Verstelbare tegenpunt.

Kenmerken:

- Losse kop.
- In de hoogte verstelbare tegenpunten

Geschikt voor:

- draaitafels en verdeeltafels.

Order nr.	713356155	713356157	790000017
Voor type	RT100-RT150	RT200-RTE165-RTU165	RT250 - RT300
Voor centerhoogte mm	72-108	110-145	130-200
Prijs	€ 145,00	119,00	181,00

OPTIMUM



Draai- en indexertafel met voorgebouwde klawuplaat 3kl en vergrendelingsplaten.

Troeven:

- Kwaliteits draaitafel uit hoogwaardig Meehanite gietijzer
- Met grote doorlaat om gemakkelijk grote en lange werkstukken doorheen te brengen
- Kan zowel horizontaal als verticaal gebruikt worden
- Precisie conische lagers
- Stabiliteit gegarandeerd ook onder intens gebruik
- Grote spilboring voor het spannen van lange werkstukken
- Gradenverdeling over een schaal van 360°
- Directe verdeling over vergrendelingsplaten
- Verdeling mogelijk over 24 posities (per 15°)

Geleverd met:

- 7 vergrendelingsplaten voor 2 - 3 - 4 - 6 - 8 - 12 en 24 opdelingen
- Zelfcenterende klawuplaat 3kl

Tip: wordt geleverd zonder tegenpunt, vergeet deze niet bij te bestellen.

Order nr.	713356365	790000034
Orig. nr.	RTE165	RTE200
Bouwhoogte	mm 218	257
Breedte	mm 260	312
Lengte	mm 220	258
Centerhoogte	mm 123	155
Doorlaat	mm 44	58
Taleldiameter	mm 165	200
Prijs	€ 629,00	679,00

OPTIMUM



Horizontale en verticale draai- en indexeertafel met voorgebouwde klauwplaat 3kl, vlakplaat en vergrendelingsplaten

Troeven:

- Kwaliteits draaitafel uit hoogwaardig Meehanite gietijzer
- Precisie conische lagers
- Wormaandrijving mechanisme
- Stabiliteit gegarandeerd ook onder intens gebruik
- Grote spilboring voor het spannen van lange werkstukken
- Gradenvdeling over een schaal van 360°
- Directe verdeling over vergrendelingsplaten
- Verdeling mogelijk over 24 posities (per 15°)
- Met handwielaandrijving en nonius

Geleverd met:

- 7 vergrendelingsplaten voor 2 - 3 - 4 - 6 - 8 - 12 en 24 opdelingen
- Zelfcenterende klauwplaat 3kl
- Vlakplaat met opspangleuven

Tip: wordt geleverd zonder tegenpunt en verdeelschijven, vergeet deze niet bij te bestellen

Order nr.	713354165 ^M	
Orig. nr.	RTU165	
Bouwhoogte	mm	221
Breedte	mm	250
Lengte	mm	235
Centerhoogte	mm	123
Doorlaat	mm	44
Tafeldiameter	mm	165
Diameter opspanschijf	mm	203
Prijs	€	1.039,00

MACH



Semi-universele verdeelkoppen.

Troeven:

- Deze halfuniversele verdeelkoppen kunnen iedere hoek verdelen via de directe, indirecte of differentiale methode.
- De verhouding tussen worm en wormwiel bedraagt 40:1
- Worm en wormwiel zijn gehard en geslepen
- De geharde en geslepen spindel wordt stevig vastgehouden in een conische kogellager
- De verdeelkop kan onder hoek vastgezet worden van -10° tot +90°
- Ieder model heeft een draadspil en een verdeelschijf met 24 gaten om eenvoudig en snel direct te kunnen indexeren op de nummers 2, 3, 4, 6, 8, 12 en 24
- Eenvoudige indexering van alle nummers van 2 tot 50 en vele verdelingen van 52 tot 380.
- De TA 160 is ook uitgerust met differentiaal indexering voor alle nummers van 2 tot 380 en voor spiraal snijden.
- Nauwkeurig en robuust van vorm

Standaard geleverd met:

- 3 verdeelschijven
- Verstelbaar tegenpunt
- Meenemer
- Vast centerpunt
- Met of zonder klauwplaat (zie kolom diameter klauwplaat)

Tip: universele verdeelkoppen op aanvraag

Order nr.	713356125 ^M	790000026 ^M	790000025 ^M	790000027 ^M	
Orig. nr.	TA125	TA125 M2	TA160	TA160 M3	
Bouwhoogte	mm	173	220	220	
Breedte	mm	91	114	114	
Lengte	mm	189	293	293	
Centerhoogte	mm	100	128	128	
Groefhoogte	mm	13	16	16	
Conus center	MK2	MK2	MK3	MK3	
Doorlaat	mm	18	20	20	
Klauwplaat	mm	-	125	160	
Prijs	€	469,00	795,00	689,00	925,00

Machineverlichting

OPTIMUM



LED machinelamp met magneetvoet

Troeven:

- Energiebesparend
- LED lamp met lange levensduur
- Magneetvoet ø 68 mm en montageplaat 68x68 mm
- Optimale beweeglijkheid van de arm

Geschikt voor:

- machines zonder verlichting, waar de werkzone verlicht dient te worden

Kenmerken:

- Verlichtingssterkte 250 – 330 Lux
- Scherm diameter 35 mm
- Lengte arm 400 mm
- 1.95 W / 230V aansluiting

Order nr.	713351131
Orig. nr.	3351131
Prijs	€ 83,50

OPTIMUM



Machinelamp halogeen magneet AL25.

Troeven:

- Magneetvoet ø 70 en montageplaat 68x68 mm
- Armgewicht bij de kop
- Optimale beweeglijkheid van de kop
- Slagvaste, eenvoudig te reinigen kunststofbehuizing

Geschikt voor:

- machines zonder verlichting, waar de werkzone verlicht dient te worden

Kenmerken:

- Dubbelwandige arm 500 mm
- Bescherming IP20
- Geïntegreerde transformator 20W / 230V aansluiting

Order nr.	713351145
Orig. nr.	AL25
Prijs	€ 113,00

OPTIMUM



Machinelamp halogeen met raster tegen verblinding.

Troeven:

- Geconcentreerde halogeenverlichting voorzien van interne stralingsverbredende reflector
- Raster tegen verblinding
- Alu-geribde stabiele behuizing, beschermt tegen water, olie, stof en stoten
- Aangename geringe buitentemperatuur
- Armgewicht bij de kop

Geschikt voor:

- Draaibanken, freesmachines

Kenmerken:

- Montageplaat 68x68 mm
- Armlengte 880 mm
- Bescherming IP65
- 12V – verlichting
- Geïntegreerde transformator 55W/230V aansluiting

Order nr.	713351152
Orig. nr.	AL35
Prijs	€ 120,00

OPTIMUM



Vervanglamp voor halogeen werklamp AL35.

Order nr.	710000003
Orig. nr.	HLX64610
Prijs	€ 11,50

OPTIMUM



Vergrootglas met geïntegreerde lamp.

Troeven:

- 1,5 x optische vergroting
- Diameter vergrootglas 127 mm
- Met schroevendraaier is het armgewicht eenvoudig te verstellen en vast te maken

Kenmerken:

- Arm 830 mm
- Beschermklasse IP20
- 22W / 230V aansluiting

Order nr.	713351160
Orig. nr.	ALM3
Prijs	€ 138,00

OPTIMUM



Machinelamp LED

Troeven:

- Energiebesparend.
- LED lamp met lange levensduur 60.000 werkuren.
- Hoge positioneeruauwkeurigheid.
- Optimale beweeglijkheid van de arm

Kenmerken:

- 500 mm lange beschermde arm
- kabellengte 1.2 m
- Verlichtingstemperatuur 4000 - 4500 K, natuurlijk helwit
- Beschermklasse IP64
- 24V verlichting
- 3 x 1 Watt / 230V aansluiting

Order nr.	713351010	
Orig. nr.	LED 3-500	
Prijs	€ 150,00	

OPTIMUM



Machinelamp kort. Robuuste en lichtsterke machineverlichting.

Troeven:

- Ultramoderne LED technologie
- Geringe buitentemperatuur, zodat smeer en koelmiddel niet kunnen inbranden
- Stofdicht en straalwaterbestendig
- Verdraaibare kop
- Lichtverdeling: midden breed, asymmetrisch, 25° uitstraalhoek
- Lampbescherming uit temperatuursongevoelig veiligheidsglas

Kenmerken:

- Beschermklasse IP65 (lampenkop)
- Kleurtemperatuur 4000 - 4500 K
- Lengte kabel circa 1.2 m
- Kleur zilver/zwart
- LED 8 x 1W
- 230V - 50Hz

Order nr.	713351021	
Orig. nr.	LED 8-100	
Prijs	€ 167,00	

OPTIMUM



Machinelamp midden LED. Robuuste en lichtsterke machineverlichting:

Troeven:

- Ultramoderne LED technologie
- Geringe buitentemperatuur, zodat smeer en koelmiddel niet kunnen inbranden
- Stofdicht en straalwaterbestendig
- Verdraaibare kop
- Lichtverdeling: midden breed, asymmetrisch, 25° uitstraalhoek
- Lampbescherming uit temperatuursongevoelig veiligheidsglas

Kenmerken:

- Gelede armlengte 505 mm
- Beschermklasse IP65 (lampenkop)
- Kleurtemperatuur 4000 - 4500 K
- Lengte kabel circa 1.2 m
- Kleur zilver/zwart
- LED 8 x 1W
- 230V - 50Hz

Order nr.	713351026	
Orig. nr.	LED 8-600	
Prijs	€ 179,00	

OPTIMUM



Machinelamp lang LED. Robuuste en lichtsterke machineverlichting:

Troeven:

- Ultramoderne LED technologie
- Geringe buitentemperatuur, zodat smeer en koelmiddel niet kunnen inbranden
- Stofdicht en straalwaterbestendig
- Verdraaibare kop
- Lichtverdeling: midden breed, asymmetrisch, 25° uitstraalhoek
- Lampbescherming uit temperatuursongevoelig veiligheidsglas

Kenmerken:

- Gelede armlengte 720 mm
- Beschermklasse IP65 (lampenkop)
- Kleurtemperatuur 4000 - 4500 K
- Lengte kabel circa 1.2 m
- Kleur zilver/zwart
- LED 8 x 1W
- 230V - 50Hz

Order nr.	713351027	
Orig. nr.	LED 8-720	
Prijs	€ 185,00	

Tappen -& kussensets



7-delige set van 3 in 1 combi-machinetappen.

Geschikt voor:

- Voor staal, aluminium, plastic tot Renlt;600 N/mm² en diepte 1 x D.
- Voor accu boormachines en schroevendraaiers

Troeven:

- Metrisch M3 - M4 - M5 - M6 - M8 - M10
- Kwaliteit: HSS-G (geslepen)
- Deze machinetap combineert 3 functies in 1 beweging: boren, draadtrekken en verzinkboren.
- 1 magnetische bitshouder met 1/4 zeskantaansluiting
- Verpakt in een kunststof opbergcassette.

Tip: Combi 3 in 1 boor-tap-verzink kunnen ook afzonderlijk verkregen worden

Order nr.	747150310
Orig. nr.	SKC7ETM
Maten	M3 - M4 - M5 - M6 - M8 - M10
Aantal stuks	6
Type tap	Machinetap
Prijs	€ 54,90



7-delige set van HSS M2 doorlopende machinetappen.

Troeven:

- Metrische schroefdraad.
- Kwaliteit HSS-G hardheid HV 750
- DIN 371B en vanaf M12 DIN 376B
- Vorm B voor doorlopende gaten 5 gangen
- Taphoek 60°
- Smearing vereist voor optimale prestaties
- Verpakt in een hoogwaardige kunststof doos.

Geschikt voor:

- algemeen tapwerk in staal
- tapapparaten, tapkoppen, pneumatische taparmen

Order nr.	713051057
Orig. nr.	MTMS7
Maten	M3 - M4 - M5 - M6 - M8 - M10 - M12
Aantal stuks	7
Type tap	Machinetap
Prijs	€ 34,90



15-delige HSS M2 set machinetappen en boren.

Bestaande uit:

- 7 HSS doorlopende machinetappen gaande van M3 tot M12
- Tappenhouder M3-M12
- 7 corresponderende geslepen boren voor de tapsen.
- Verpakt in een hoogwaardige kunststof doos.

Order nr.	713051015
Orig. nr.	MTMS15
Maten	M3 - M4 - M5 - M6 - M8 - M10 - M12
Aantal stuks	15
Maten boren	mm 2,5 - 3,3 - 4,2 - 5,0 - 6,8 - 8,5 - 10,2
Type tap	Machinetap
Prijs	€ 51,50



17-delige tappen- en snijkussenset. TC-tray

Bestaat uit:

- 6 tappen en 6 snijkussens gaande van M3 tot M12
- 1 kussenhouder
- 1 taphouder
- 1 draadsnijmeter

Order nr.	69190106
Orig. nr.	TTD17
Maten	M3 - M4 - M5 - M6 - M8 - M10 - M12
Type tap	Handtap
Prijs	€ 44,90



21-delige set van HSS-G handtappen DIN352.

Troeven:

- Metrisch gaande van M3 - M4 - M5 - M6 - M8 - M10 - M12,
- Volgens DIN352.
- Kwaliteit HSS-G
- Elke handtap bestaat uit een set van 3 tappen.
- Verpakt in een stevige kunststof koffer.

Order nr.	742140401
Orig. nr.	SKC21ETM
Maten	M3 - M4 - M5 - M6 - M8 - M10 - M12
Aantal stuks	21
Type tap	Handtap
Prijs	€ 90,50

Het gebruik van tappen

Als je werkt met tappen, moet je steeds op het volgende letten:

- Zet de tap steeds haaks ten opzichte van het werkstuk.
- Terwijl je draad snijdt, mag je nooit stoppen met snijden. Je voegt dus snijolie toe terwijl je snijdt, zo zal het tappen vlotter verlopen en slijt de tap minder vlug.
- Na iedere halve slag snijden, dient men de tap een kwartslag terug te draaien om de spaan af te breken.
- Reinig je tappen na gebruik.
- Let erop dat je de tappen niet laat vallen om breken te vermijden.

Tappen: de verschillende maten

De diameter van het vooraf te boren gat is zeer belangrijk voor het verkrijgen van een goed gesneden binnendraad. Voor het tappen moet het geboorde gat kleiner zijn dan de buitendiameter van de tap. In deze tabel vind je de boordiameters die aangegeven zijn van veel voorkomende metrische schroefdraad voor staal en messing.

Schroefdraadmaat	Boordiameter
M3	2,5 mm
M4	3,3 mm
M5	4,2 mm
M6	5 mm
M8	6,8 mm
M10	8,5 mm
M12	10,5 mm

MACH



30-delige tappen- en kussenset

Troeven:

- Cap. M3 tot M12 Metrisch
- Kwaliteit: HSS-G (geslepen)
- Europese kwaliteit

Bestaat uit:

- 21 Handtappen DIN352 (set van 3 stuks)
M3 - M4 - M5 - M6 - M8 - M10 - M12
- 1 verstelbare taphouder 1 1/2
- 7 Corresponderende snijkussens
- 1 vaste ronde snijkussen houder ø 25x9 mm
- Verpakt in een metalen koffer.

Order nr.	742140501
Orig. nr.	SKC30ETM
Maten	3 - 4 - 5 - 6 - 8 - 10 - 12
Aantal stuks	30
Type tap	Handtap
Prijs	€ 125,00

MACH



40-delige kussen- en tappendoos

Troeven:

- Metrisch
- Kwaliteit: Tungsten staal

Bestaan uit:

- 17 handtappen:
M3X0,5 - M3X0,6 - M4X0,7 - M4X0,75 - M5X0,8 - M5X0,9 - M6X1,0 - M6X0,75 - M7X0,75 - M7X1,0 - M8X1,0 - M8X1,25 - M10X1,25 - M10X1,50 - M12X1,5 - M12X1,75 - 1/8"NPT
- 1 verstelbare taphouder M3-M12
- 1 taphouder kort met T hendel
- 17 bijhorende snijkussens
- 1 vaste ronde snijkussen houder ø 25.4
- 1 schroevendraaier
- 1 draadsnijkaliber
- Met degelijke inleg
- In kunststof koffer

Order nr.	748104040
Orig. nr.	SKC40ETM
Aantal stuks	40
Type tap	Handtap
Prijs	€ 39,90

MACH



110-delige kussen- en tappendoos, metrisch M2 tot M18.

Troeven:

- Cap. M2 tot M18
- Metrische maten
- Kwaliteit: Tungsten staal

Bestaat uit:

- 70 handtappen (set van 2 stuks):
M2X0,4 - M3X0,5 - M4X0,7 - M5X0,8 - M6X0,75 - M6X1,0 - M7X0,75 - M7X1,0 - M8X0,75 - M8X1,0 - M8X1,25 - M9X0,75 - M9X1,0 - M9X1,25 - M10X0,75 - M10X1,0 - M10X1,25 - M10X1,5 - M11X0,75 - M11X1,0 - M11X1,25 - M11X1,5 - M12X0,75 - M12X1,0 - M12X1,25 - M12X1,5 - M12X1,75 - M14X1,0 - M14X1,25 - M14X1,5 - M14X2,0 - M16X1,0 - M16X1,5 - M16X2,0 - M18X1,5
- 1 verstelbare tappenhouter M6-M20
- 1 verstelbare tappenhouter M3-M12
- 1 taphouder kort met T hendel
- 35 corresponderende snijkussens
- 1 vaste ronde snijkussen houder ø 25,4
- 1 vaste ronde snijkussen houder ø 38.1
- Met degelijke inleg
- In stevige metalen doos.

Order nr.	748401100
Orig. nr.	SKC110ETM
Aantal stuks	110
Type tap	Handtap
Prijs	€ 119,00

MACH



110-delige kussen- en tappendoos, UNC-UNF-UNS-NPT

Troeven

- UNC, UNF, UNS, NPT, Metriek
- Kwaliteit: Tungsten staal

Bestaat uit:

- 70 handtappen (set van 2 stuks):
- UNC tappen:
Nr. 4x40 UNC - Nr. 6x32 UNC - Nr. 8x32 UNC - Nr. 10x24 UNC - Nr. 12x24 UNC
1/4"x20 UNC - 5/16"x18 UNC - 3/8"x16 UNC - 7/16"x14 UNC
1/2"x13 UNC - 9/16"x12 UNC - 5/8"x11 UNC - 3/4"x10 UNC
- UNF tappen:
No. 10x32 UNF - 1/4"x28 UNF - 5/16"x24 UNF - 3/8"x24 UNF - 7/16"x20 UNF
1/2"x20 UNF - 9/16"x18 UNF - 5/8"x18 UNF - 3/4"x16 UNF
- UNS tappen:
1/4"x24 UNS - 1/4"x32 UNS
- NPT tappen:
1/8"NPT - 1/4"NPT
- Metrische tappen:
M6X1,0 - M8X1,25 - M10X1,5 - M10X1,0 - M11X1,5 - M12X1,25 - M12X1,75 - M14X1,25 - M18X1,5
- 1 verstelbare tappenhouter 1/16" - 1/2"
- 1 verstelbare tappenhouter 1/4" - 3/4"
- 1 taphouder kort met T hendel
- 35 corresponderende snijkussens
- 1 vaste ronde snijkussen houder 1"
- 1 vaste ronde snijkussen houder 1 1/2"
- Met degelijke inleg
- Geleverd in een stevige metalen doos

Order nr.	748401200
Orig. nr.	SKC110ETS
Aantal stuks	110
Type tap	Handtap
Prijs	€ 122,00

Tappen



Set van 3 handtappen. Metriek.

Troeven:

- DIN352
- Metrische schroefdraad.
- Kwaliteit HSS - hardheid HRC 62-63

Geslacht voor:

- Materialen tot enlt; 600N/mm²

Tip: Andere maten tot M36x4 op aanvraag.

Order nr.	Orig. nr.	Maat M	Snijlengte mm	Totale lengte mm	Prijs €
748440305	SKCT3M3X05HSS	3x0,5	12	40	16,90
748440407	SKCT3M4X07HSS	4x0,7	14	45	16,90
748440508	SKCT3M5X08HSS	5x0,8	16	48	16,90
748440610	SKCT3M6X10HSS	6x1,0	18	50	17,50
748440710	SKCT3M7X10HSS	7x1,0	18	50	23,90
748448125	SKCT3M8X125HS	8x1,25	22	56	19,50
748449125	SKCT3M9X125HS	9x1,25	22	63	31,90
748441015	SKCTM10X15SHS	10x1,5	25	70	24,90
748441115	SKCT3M11X15HS	11x1,50	25	70	42,90
748442175	SKCT3M12X175HS	12x1,75	30	75	30,90



Set van 2 handtappen. Metriek.

Troeven:

- DIN2181
- Metrische schroefdraad.
- Kwaliteit HSS - hardheid HRC 62-63

Geslacht voor:

- Materialen tot enlt; 600N/mm²

Order nr.	Orig. nr.	Maat M	Snijlengte mm	Totale lengte mm	Prijs €
748413223	SKCTM2X04	2x0,4	11	36	6,60
748413324	SKCTM3X05	3x0,5	12	40	6,60
748413425	SKCTM4X07	4x0,7	14	45	6,60
748413526	SKCTM5X08	5x0,8	16	48	6,80
748413627	SKCTM6X075	6x0,75	18	50	8,50
748413728	SKCTM6X10	6x1,0	18	50	6,80
748413829	SKCTM7X075	7x0,75	18	50	9,40
748413930	SKCTM7X10	7x1,0	18	50	7,40
748414031	SKCTM8X075	8x0,75	22	56	8,30
748414132	SKCTM8X10	8x1,0	22	56	8,30
748414233	SKCTM8X125	8x1,25	22	56	7,70
748414334	SKCTM9X075	9x0,75	22	63	12,90
748414435	SKCTM9X10	9x1,0	22	63	12,90
748414536	SKCTM9X125	9x1,25	22	63	12,90
748411075	SKCTM10X075	10x0,75	25	70	11,90
748411102	SKCTM10X10	10x1,0	25	70	11,90
748411203	SKCTM10X125	10x1,25	25	70	11,90
748411304	SKCTM10X15	10x1,5	25	70	10,50
748411405	SKCTM11X075	11x0,75	25	80	16,90
748411506	SKCTM11X10	11x1,0	25	70	16,90
748411607	SKCTM11X125	11x1,25	25	70	16,90
748411708	SKCTM11X150	11x1,50	25	70	10,90
748411809	SKCTM12X075	12x0,75	30	75	12,90
748411910	SKCTM12X10	12x1,0	30	75	12,90
748412011	SKCTM12X125	12x1,25	30	75	12,90
748412112	SKCTM12X15	12x1,5	30	75	12,90
748412213	SKCTM12X175	12x1,75	30	75	11,90
748412314	SKCTM14X10	14x1,0	32	80	15,90
748412415	SKCTM14X125	14x1,25	32	80	15,90
748412516	SKCTM14X15	14x1,5	32	80	15,90
748412617	SKCTM14X20	14x2,0	32	80	14,90
748412718	SKCTM16X10	16x1,0	32	80	16,90
748412819	SKCTM16X15	16x1,5	32	80	16,90
748412920	SKCTM16X20	16x2,0	32	80	15,50
748413021	SKCTM18X15	18x1,5	32	80	18,50



Set van 2 handtappen BSP (GAS).

Troeven:

- DIN5157
- Recht cilindrisch.
- BSP (GAS) schroefdraad.
- Kwaliteit HSS - hardheid HRC 62-63

Geslacht voor:

- Materialen tot enlt; 600N/mm²



Andere maten op aanvraag G1/8", G1/4" en G3/8"

Order nr.	Orig. nr.	Maat	Snijlengte mm	Totale lengte mm	Prijs €
748411141	HTBSP3/8	G3/8x19	25	75	8,70
748411512	HTBSP1/2	G1/2x14	31	80	15,90
748411534	HTBSP3/4	G3/4"x14	33	90	28,50
748411510	HTBSP1	G1"x11	39	100	95,50
748411514	HTBSP1-1/4	G1"-1/4x11	32	125	109,00
748411513	HTBSP1-1/2	G1"-1/2x11	32	140	144,00
748411520	HTBSP2	G2"x11	32	140	377,00



Handtap 1-delig BSPT

Troeven:

- UNI6125
- Conisch 1:16.
- BSPT schroefdraad.
- Kwaliteit HSS - hardheid HRC 62-63

Geslacht voor:

- Materialen tot enlt; 600N/mm²



Order nr.	Orig. nr.	Maat	Snijlengte mm	Totale lengte mm	Prijs €
748411718	HTBSPT1/8	Rc 1/8"x28	15	59	13,90
748411714	HTBSPT1/4	Rc 1/4"x19	19	67	20,50
748411738	HTBSPT3/8	Rc 3/8"x19	21	75	23,90
748411712	HTBSPT1/2	Rc 1/2"x14	26	87	28,50
748411734	HTBSPT3/4	Rc 3/4"x14	28	96	81,90
748411710	HTBSPT1	Rc 1"x11	33	109	119,00
748411715	HTBSPT1-1/4	Rc 1"-1/4x11	36	119	182,00
748411716	HTBSPT1-1/2	Rc 1"-1/2x11	37	125	267,00
748411720	HTBSPT2	Rc 2"x11	41	140	399,00



HSS-G machinetap voor doorlopende gaten

Troeven:

- Metrische schroefdraad.
- Kwaliteit HSS-G hardheid HV 750
- DIN 371B en vanaf M12 DIN 376B
- Vorm B voor doorlopende gaten 5 gangen
- Taphoek 60°
- Smering vereist voor optimale prestaties

Geslacht voor:

- Staalsoorten enlt; 700N/mm²



Verpakt per stuk.

Order nr.	Orig. nr.	Maat M	Snijlengte mm	Totale lengte mm	Diame-ter mm	Vierkant mm	Prijs €
747143050	MTBM03050	3X0,5	11	56	3,5	2,7	6,00
747144070	MTBM04070	4X0,7	13	63	4,5	3,4	6,00
747145080	MTBM05080	5X0,8	16	70	6	4,9	6,00
747146100	MTBM06100	6X1,0	19	80	6	4,9	6,30
747148125	MTBM08125	8x1,25	22	90	8	6,2	7,40
747141015	MTBM10150	10X1,50	24	100	10	8	8,50
747141217	MTBM12175	12X1,75	29	110	9	7	10,50
747141420	MTBM14200	14X2,00	30	110	11	9	15,90
747141620	MTBM16200	16X2,00	32	110	12	9	18,50
747141825	MTBM18250	18X2,50	34	125	14	11	22,90

Draadsnijkkussens

MACH



Ronde draadsnijkkussens. Metriek en Metriek fijn

Troeven

- DIN223.
- HSS kwaliteit.
- Materiaal HRC 60-61.
- Gewone metrische schroefdraad en metrisch fijn.

Geslacht voor:

- Metalen met een geringe hardheid tot enlt; 600 N/mm²
- Alu
- Koper
- Zink

Andere maten op aanvraag.

Order nr.	Maat	Buiten-diameter	Dikte	Voor kussenhouder	Me-tri-riek	Metriek fijn	Prijs
	M	mm	mm				€
748431511	M 2x0,4	25,4	9	748420259	✓		4,20
748431521	M 3x0,5	25,4	9	748420259	✓		4,20
748431531	M 4x0,7	25,4	9	748420259	✓		4,20
748431541	M 5x0,8	25,4	9	748420259	✓		4,20
748431561	M 6x1,0	25,4	9	748420259	✓		4,20
748431581	M 7x1,0	25,4	9	748420259	✓		4,20
748431591	M 8x0,75	25,4	9	748420259		✓	4,20
748431601	M 8x1,00	25,4	9	748420259		✓	4,20
748431611	M 8x1,25	25,4	9	748420259	✓		4,20
748431621	M 9x0,75	25,4	9	748420259		✓	4,20
748431631	M 9x1,0	25,4	9	748420259		✓	4,20
748431281	M 10x0,75	38,1	14	748423814		✓	5,30
748431301	M 10x1	38,1	14	748423814		✓	5,30
748431311	M 10x1,25	38,1	14	748423814		✓	5,30
748431320	M 10x1,5	25,4	9	748420259		✓	4,10
748431321	M 10x1,5	38,1	14	748420259	✓		5,30
748431331	M 11x0,75	38,1	14	748423814		✓	5,30
748431341	M 11x1,0	38,1	14	748423814		✓	5,30
748431351	M 11x1,25	38,1	14	748423814		✓	5,30
748431361	M 11x1,5	38,1	14	748423814	✓		5,30
748431275	M 12x0,75	38,1	14	748423814		✓	5,30
748431381	M 12x1,0	38,1	14	748423814		✓	5,30
748431391	M 12x1,25	38,1	14	748423814		✓	6,40
748431401	M 12x1,5	38,1	14	748423814		✓	5,30
748431411	M 12x1,75	38,1	14	748423814	✓		5,30
748431431	M 14x1,25	38,1	14	748423814		✓	5,30
748431441	M 14x1,5	38,1	14	748423814		✓	5,30
748431451	M 14x2,0	38,1	14	748423814	✓		5,30
748431471	M 16x1,5	38,1	14	748423814		✓	5,30
748431481	M 16x2,0	38,1	14	748423814	✓		5,30
748431491	M 18x1,5	38,1	14	748423814		✓	5,30

TENGTTOOLS



Tappen en snijkussens uit TTTD17.

Order nr.	Orig. nr.	Inhoud	Maten M	Stijging mm	Prijs €
116830100	TDD03050		3	0,5	6,20
116830209	TDD04070	Kussen	4	0,7	6,20
116830308	TDD05080	Kussen	5	0,8	6,20
116830407	TDD06100	Kussen	6	1	6,20
116830506	TDD08125	Kussen	8	1,25	6,20
116830605	TDD10150	Kussen	10	1,5	6,20
116830704	TDD12175	Kussen	12	1,75	6,20
116831009	TDT03050	Tap	3	0,5	3,80
116831108	TDT04070	Tap	4	0,7	3,80
116831207	TDT05080	Tap	5	0,8	4,20
116831306	TDT06100	Tap	6	1	4,20
116831405	TDT08125	Tap	8	1,25	4,80
116831504	TDT10150	Tap	10	1,5	5,40
116831603	TDT12175	Tap	12	1,75	5,60

MACH



Draadsnijkkussens UNF / UNC.

Troeven:

- DIN223
- Tungsten staal.
- UNF/UNC maten
- Materiaal HRC 60-61

Geslacht voor:

- Metalen met een geringe hardheid tot enlt; 600 N/mm²
- Alu
- Koper
- Zink

Order nr.	Maat	Buiten-diameter	Dikte	Voor kus-senhouder	UNC	UNF	Prijs
		mm	mm				€
748431161	M 5UNC40	25,4	9	748420259	✓		5,40
748431221	M 6UNC32	25,4	9	748420259	✓		5,40
748431251	M 8UNC32	25,4	9	748420259	✓		4,20
748431081	M 10UNC24	25,4	9	748420259	✓		4,60
748431101	M 12UNC24	25,4	9	748420259	✓		4,60
748431231	M 7/16UNC14	38,1	14	748423814	✓		8,50
748431261	M 9/16UNC12	38,1	14	748423814	✓		12,50
748431191	M 5/8UNC11	50,8	16	998270001	✓		14,90
748431121	M 3/4UNC10	50,8	16	998270001	✓		19,50
748431091	M 10UNF32	25,4	9	748420259		✓	6,20
748431051	M 1/4UNF28	25,4	9	748420259		✓	5,00
748431271	M 9/16UNF18	38,1	14	748423814		✓	12,50
748431201	M 5/8UNF18	50,8	16	998270001		✓	14,90

MACH



Ronde draadsnijkkussens. BSP (GAS)

Troeven:

- DIN223.
- HSS kwaliteit.
- Materiaal HRC 60-61.
- BSP GAS schroefdraad. (EN 24231).

Geslacht voor:

- Metalen met een geringe hardheid tot enlt; 600 N/mm²
- Alu
- Koper
- Zink.

Andere maten op aanvraag.

Order nr.	Maat	Buitendiameter	Dikte	Voor kussenhouder	GAS BSP	Prijs
		mm	mm			€
748431300	1/8x28	38.1	14	748420103	✓	8,30
748431302	1/4x19	38.1	14	748420103	✓	8,30
748431303	3/8x19	38.1	14	748420103	✓	8,30
748431304	1/2x14	50.8	16	748420103	✓	15,90
748431305	3/4x14	50.8	16	748420104	✓	15,90
748431306	1x11	63.5	19	748420104	✓	29,90

Wringijzerkussens en tappenhouders

MACH



Kussenhouder voor ronde snijkkussens.

Troeven

- DIN225 (EN225568)
- Type vast.
- Kwaliteit Zinklegering.

Ook beschikbaar in staal op aanvraag.

Order nr.	Orig. nr.	Diameter mm	Lengte mm	Maat	Gewicht kg	Prijs €
748420165	SKCDH165	16x5	160	M1-2.6	0,06	7,40
748420205	SKCDH205	20x5	165	M3-4	0,08	7,80
748420207	SKCDH207	20x7	185	M4.5-6	0,08	7,80
748420259	SKCDH259	25,4x9	215	M7-9	0,11	8,30
748423011	SKCDH3011	30x11	265	M10-11	0,19	13,50
748423814	SKCDH3814	38,1x14	315	M12-14	0,29	14,90

TENGI TOOLS



Wringijzer voor de Teng kussens van M3 tot M12 uit TTTD17.

Order nr.	144100104	
Orig. nr.	DIEHNDL	
Lengte	mm	255
Gewicht	kg	0,13
Afmetingen (l x b x h)	mm	12 x 45 x 255
Prijs	€	7,10

MACH



Verstelbare tappenhouder volgens DIN1814 voor tappen.

Troeven:

- Kwaliteit zinklegering
- Volgens DIN1814.

Ook beschikbaar is staal op aanvraag.

Order nr.	Orig. nr.	Gr.	Lengte mm	Maat	Gewicht kg	Prijs €
748420100	SKCTW0	0	130	1-8	0,05	11,90
748420101	SKCTW1	1	188	1-10	0,10	12,90
748421112	SKCTW112	1 1/2	180	1-12	1,00	13,90
748420102	SKCTW2	2	280	4-12	0,28	20,50
748420103	SKCTW3	3	380	5-20	0,65	30,90

TENGI TOOLS



Taphouder voor de Teng tappen uit TTTD17.

Order nr.	116940107	
Orig. nr.	TAPHNDL	
Gr.	2	
Maximum vierkant opening	mm	3-12
Gewicht	kg	0,15
Prijs	€	7,20

MACH



Tappenhouder met vaste T-hendel.

Troeven

- Korte alsook lange type.
- Vaste T-hendel

Andere groottes op aanvraag.

Order nr.	Orig. nr.	Gr.	Lengte mm	Maat	Type	Gewicht kg	Prijs €
748421203	SKCWK2	2	78	M 5-10	kort	0,12	9,30
748421204	SKCWK3	3	102	M 6-12	kort	0,15	12,90
748421211	SKCWL1	1	150	M 0-4	lang	0,11	15,50
748421212	SKCWL2	2	150	M 5-10	lang	0,17	18,50
748421213	SKCWL3	3	150	M 6-12	lang	0,22	24,90



Tappenhouder met ratel.

Troeven

- Kwaliteit staal.
- Korte en lange type.
- Met ratel
- Voor gebruik in beperkte ruimtes.

Order nr.	Orig. nr.	Gr.	Lengte mm	Maat	Type	Gewicht kg	Prijs €
748421401	SKCTWRK1	1	85	M 3-10	kort	0,17	23,50
748421402	SKCTWRK2	2	100	M 5-12	kort	0,33	26,90
748421411	SKCTWRL1	1	250	M 3-10	lang	0,26	23,90
748421412	SKCTWRL2	2	300	M 5-12	lang	0,44	29,90

Schroefdraadherstelsets



FINE SPOED

Set draaendeuithalers "Out-you-Come" N°1-N°6.

Troeven:

- Hoog carbon staal
- **Nummers 1 tot 6**
- Met een bereik van M3 tot M24
- Spiraalvormig
- Fijne spoed
- Linkse draad
- Voor het verwijderen van bouten en schroeven

Tip: Iedereen heeft wel al eens verveeld gezeten met een doorgedraaide schroef of een afgebroken bout. Wat dan? Met de "Out-you-Come" draaendeuithalers bieden wij hiervoor de oplossing. De schroef of bout wordt eerst precies op de geschikte diameter voor de draaendeuithaler geboord. Vervolgens brengt u de uithaler in het gat en draait u tegen wijzerzin met behulp van een wringijzer, deze worden eveneens verkocht op onze website. De spiralen boren zich vervolgens een weg in de schroef of bout, door de linkse draad en de rechtse draaibeweging met het wringijzer, verwijdert u vervolgens de bout of schroef.

Order nr.	748529000
Orig. nr.	DEU16
Prijs	€ 9,80



Schroefdraad herstelset - Metrisch - M5 tot M12.

Troeven:

- Set speciaal voor het herstellen van schroefdraad.

Werking:

- Eerst wordt de kapotte draad uitgeboord, waarna een nieuwe draad wordt getrokken en een spoel wordt geplaatst.

Tip: Andere sets op aanvraag M, BSW, BSF, UNC, UNF

Order nr.	748300201
Orig. nr.	SDHM5M12
Tapmaten	Me- trisch 5x0,8 - 6x1,0 - 8x1,25 - 10x1,5 - 12x1,75
Geschikt voor boor	mm 5,2 - 6,3 - 8,3 - 10,4 - 12,4
Outil d'insertion	n°. 8 - 9 - 11 - 13 - 15
Breekgereedschap	nr. 8 - 9 - 11 - 13 - 15
Aantal stuks draadcoils	25 (M5) - 25 (M6) - 25 (M8) - 25 (M10) - 10 (M12)
Prijs	€ 198,00



Draadinzet uit roestvrijstaal.

Troeven:

- Lengte is 1,5 x diameter.
- K-Coil insert inox.
- DIN8140.

Werking:

- U plaatst de draadinzet in het geboord gat en u hebt opnieuw draad.

Order nr.	Orig. nr.	Maten	VE	Prijs/VE €
748300508	748300508	M5x0,8	100	41,50
748300601	748300601	M6x1,0	100	45,50
748300125	748300125	M8x1,25	100	55,50
748300115	748300115	M10x1,5	100	81,90
748301125	748301125	M12x1,75	1	123,00

Kottergereedschap

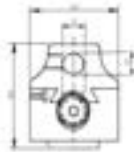

Precisiekotterkop type C.

Geschikt voor:

- Universeel inzetbaar bij boringen, uitdraaien voor het herstellen van pasboringen, binnendraad, etc.

Kenmerken:

- Nauwkeurig op 0.01 mm.
- Horizontaal en verticaal bruikbaar.
- Uit hoogwaardig kwaliteitsstaal, gehard en precisiesegeslepen.
- Voorzien van binnendraad.

Na het kiezen van de gewenste kotterkop, kiest u een gepaste kegeldoorn en set beitels.

Order nr.	Aansluiting	Diameter mm	Gereedschap	Capaciteit mm	Prijs €
790003948	M 1-1/2" x 18	50	12	10-125	63,50
790003950	M 1-1/2" x 18	75	18	12225	83,50
790003952	M 1-1/2" x 18	100	25	15-320	153,00



Kegeldoorn voor precisiekotterkop type C.

Geschikt voor:

- De meest voorkomende machines.

Kenmerken:

- Kegeldoorn kan van tijd tot tijd veranderd worden.
- Voor aansluiting zijde kotterkop 1-1/2" x 18 stappen.

Order nr.	Aansluiting	Voor machine	Prijs €
790007222	MK2	B20/B23 Pro/etc	36,90
790003944	MK3	B25-3/B26 Pro/etc	38,50
790003945	MK4	B40GSP/B50GSM	38,50
790007223	MK2 / M10	BF16 / BF20 / BF20L	36,90
790007224	MK3 / M12	MH28V/BF30/F40E	36,90
790003947	MK4 / M16	MB4/MB4P	39,90
790003942	ISO30	BF30	44,90
790003943	ISO40	BF46 / MF2 / MF4 / UF100	47,90



Set beitels met Tungsten hardmetalen plaatjes voor kotterkoppen.

Order nr.	Aantal	Schacht mm	Voor	Prijs €
713440912	9	12	KKC2	46,90
790007225	12	18	KKC3	59,50
790007226	6	25	KKC4	83,50



Precisie kotterkop met 8 boorstangen.

Troeven:

- Keuze uit 3 aansluitingen DIN2080: ISO30 of ISO40 of ISO50.

Geleverd met:

- 8 boorstangen BJ2008-32L / BJ2010-40L / BJ2014-53L / BJ2016-68L / BJ2020-83L / BJ2025-96L / BJ2030-115L / BJ20-L20-100L
- Bouten en diametervergroting
- Degelijke koffer

Tip: wordt geleverd zonder wisselplaten, vergeet deze niet bij te bestellen.

Order nr.	Aansluiting ISO	Aantal	Prijs €
713352127	M 30	8	1.295,00
713352128	M 40	8	1.295,00
713352129	M 50	8	1.295,00

Voor boorfreesmachines

OPTIMUM

Automatische voeding voor de X-as van de BF20.



Troeven:

- Traploos regelbare snelheid -set eindeloopschakelaars
- Links/rechts draaiend
- Noodstop functie
- Ingebouwde koelribben
- Aandrijving via een stappenmotor zonder CNC controller

Geslacht voor:

- in combinatie met 713570015
- BF20, BF20L, BF20LD

Indien u dit artikel op een nieuwe boorfreesmachine wil laten installeren, vergeet dan uw 2 werkuren niet op te geven.

Order nr.	713571941 ^M
Prijs	€ 334,00

OPTIMUM

Montageset X-as MK F20X.

Bestaande uit:

- Stappenmotor
- Behuizing incl. deksel
- Aandrijfriempjes
- 2 riemenschijven
- Montagering
- Elektrische kabel
- Schroevenset



Geslacht voor:

- Te gebruiken in combinatie met 713571941.

Order nr.	713570015 ^M
Prijs	€ 282,00

OPTIMUM

Universele voedingsmotor voor de langsrichting (X as)



Troeven:

- Horizontale montage.
- Met traploze regeling van het toerental en ijlgang.
- Rechts-links lopend.
- Transformator, overbelastingsbeveiliging en eindeloopschakelaar.
- Voor zelfmontage.

Geslacht voor:

- boorfreesmachines, waar een verticale voeding niet kan geplaatst worden
- MB4, BF30, BF46, etc.

Tip: vergeet uw bijhorende montageset voor BF30 / F40E niet bij te bestellen 713352035, alsook de montageset niet voor de BF46 - 713352036. MB4 op aanvraag.

Indien u dit artikel op een nieuwe boorfreesmachine wil laten installeren, vergeet dan uw 2 werkuren niet op te geven.

Order nr.	713352022 ^M
Type	V 99
Voor type	BF30 / BF46 / F40E
Snelheid	tpm 0 - 165
Ijlgang	tpm 240
Prijs	€ 460,00

OPTIMUM

Montageset voor V99.

Geslacht voor:

- Monteren van automatische voeding X-as op BF30, F40E en BF46.



Order nr.	713352035 ^M	713352036 ^M
Voor type	BF30 - F40E	BF46
Prijs	€ 82,90	91,50

OPTIMUM

Universele voedingsmotor voor de langsrichting (X as) en dwarsrichting (Y as) voor de meeste torenfreesmachines, zoals MF2 en MF4.



Troeven:

- Met traploze regeling van het toerental en ijlgang.
- Rechts-links lopend.
- Transformator, overbelastingsbeveiliging en eindeloopschakelaar.
- Voor zelfmontage.

Geslacht voor:

- de meeste torenfreesmachines
- MF2 / MF4

Tip: Indien u dit artikel op een nieuwe freesmachine wil laten

Order nr.	713352029 ^M	713352025 ^M
Type	V 250 X as	V 250 Y as
Voor type	MF2 / MF4	MF2 / MF4
Snelheid	tpm 5 - 160	5 - 160
Ijlgang	tpm 200	200
Prijs	€ 529,00	545,00

MAGH

Pneumatische gereedschapsaantrekker DIN2080.



Troeven:

- Verschillende aansluitingen mogelijk DIN2080: ISO30, ISO40 en ISO50.
- Hoog bereikbaar vacuüm, korte wisseltijden door bediening met één hand.
- Gering gewicht door geoptimaliseerde structuur.
- Veilige vergrendeling door het principe van de kniehefboom.
- Preciese geleiding door geoptimaliseerde geometrie.
- Gering luchtverbruik, lichte bouw, gemakkelijke aansluiting.

Geslacht voor:

- de meeste torenfreesmachines, zoals MF2, MF4
- Bepaalde boorfreesmachines BF30, BF46, mits adapterplaat 713352391 of 713352392

Geleverd met

- Motor, aantrekstang, lucht en oliefilter en stuurkast.

Tip: wordt ongemonteerd geleverd.

Order nr.	713352393 ^M	713352394 ^M	790000511 ^M
Konus	ISO30 DIN2080	ISO40 DIN2080	ISO50 DIN2080
Snelheid	tpm 3000	3000	3000
Luchtdrukverbruik	psi 90	90	90
Klemkracht	kg/cm ² 6,3	6,3	6,3
Spanning	V 220V DC24V	220V DC24V	220V DC24V
Prijs	€ 835,00	835,00	1.099,00



Universele beschermingslat voor T-gleuven.

Troeven:

- Beschermt uw T-gleuven en bespaart tijd bij het reinigen van de T-gleuven.
- Minder spanen in de koelmelk.
- Vervaardigd uit geanodiseerd aluminium.

Geschikt voor:

- Boorfreemachines, freesmachines, CNC machinecenters, etc.

Order nr.	Aantal stuks	T-gleuf mm	Lengte mm	Voor machine	Prijs €
790000593	6	10	300	BF16	41,90
790000594	6	12	400	BF20-BF20L-BF30-F40E	41,90
790000595	6	14	400	UF100	41,90
790000596	6	16	400	F30-F45-MF2-MF4	47,50
790000597	6	18	450	BF46 Vario	46,90

Voor draaibanken



Universele trillingsdemper.

Troeven:

- Verankeringsvrij
- Trillingsisolierend.
- Maakt een eenvoudig waterpas zetten van de machine mogelijk.

Geschikt voor:

- Draaibanken
- Freesmachines
- Slijpmachines
- Compressoren
- Machines in het algemeen.



Order nr.	713381016	713381018
Schroefdraad	M	20
Maximum toelaatbare belasting	kg	3500
Diameter voet	mm	185
Hoogte voet	mm	39
Capaciteit	460kg (freesmachines) - 1460kg (zaagmachines, alle machines)	1600kg (freesmachines) - 3500kg (zaagmachines, alle machines)
Prijs	€ 34,90	49,90



Vaste bril.

Als een as erg lang is voor de draaibank en ook vrij zwaar, gebruiken we een vaste bril om de as te ondersteunen.

Order nr.	Voor type	Maximum buisdiameter (a) mm	Totale hoogte (b) mm	Center-hoogte (c) mm	Prijs €
713440211	TU1503V	40	145	70,5	26,90
713440231	TU2004V	50	200	100	43,90
713440361	TU2304V	50	245	125	60,50
713441315	TU2404/2406/2506	50	245	125	61,90
713441415	TU2807	55	250	140	77,90
713441461	TU3008	55	260	157	89,00

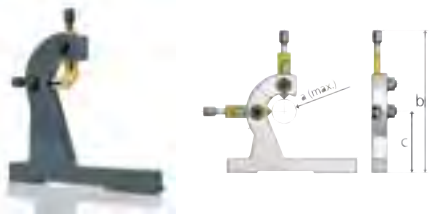

Meelopende bril. Of ook wel losse bril of volg bril genoemd.

Kenmerken:

- Voorzien van 2 toetsen en een opening waar het snijgereedschap langs kan bewegen.
- Wordt bevestigd aan de wagen ter ondersteuning van lange delen.

Order nr.	Voor type	Maximum buisdiameter (a) mm	Totale hoogte (b) mm	Center-hoogte (c) mm	Prijs €
713440210	TU1503V	45	155	76	25,90
713440230	TU2004V	40	195	100	40,90
713440360	TU2304V	34	220	107	57,90
713441310	TU2506/TU2404/TU2406	34	220	107	75,50
713441410	TU2807	56	250	130	91,50
713441460	TU3008	55	255	151	89,00

Frezen sets

OPTIMUM



12-delige TiN frezen set met Weldon schacht DIN1835B.

Troeven:

- Uitvoering met 2 of 4 snijkanten met een 30° rechtse spiraal voor betere spananafvoer voor normale tot vaste materialen.
- Titanium coating voor een hogere hardheid en een 2 tot 5 maal langere levensduur.
- Gaande van 4 tot 12mm bestaande uit 6 frezen DIN327D met 2 snijkanten en 6 frezen DIN844B met 4 snijkanten.
- Verpakt in houten kist.

Geschikt voor:

- instapfrezen
- staalsoorten tot max 600 N/mm²

Order nr.	713352113		
Orig. nr.	FSW		
Aantal stuks	12		
Frezen met 2 snijkanten	mm	4-5-6-8-10-12	
Frezen met 4 snijkanten	mm	4-5-6-8-10-12	
Prijs	€	79,90	

OPTIMUM



20-delige TiN frezen set met Weldon schacht DIN1835B.

Troeven:

- Uitvoering met 2 of 4 snijkanten met een 30° rechtse spiraal voor betere spananafvoer voor normale tot vaste materialen.
- Titanium coating voor een hogere hardheid en een 2 tot 5 maal langere levensduur.
- Gaande van 3 tot 20mm bestaande uit 10 frezen DIN327D met 2 snijkanten en 10 frezen DIN844B met 4 snijkanten.
- Verpakt in houten kist.

Geschikt voor:

- instapfrezen
- staalsoorten tot max 600 N/mm²

Order nr.	713386200		
Orig. nr.	FST		
Aantal stuks	20		
Frezen met 2 snijkanten	mm	3-4-5-6-8-10-12-14-18-20	
Frezen met 4 snijkanten	mm	3-4-5-6-8-10-12-14-18-20	
Prijs	€	148,00	

U bewerkt alu, roestvrijstaal of andere materialen en u zoekt een specifiekere frees:

Zoals 2-, 3- en 4-lippige frezen in HSSCo8% met een speciale coating TiN, TiAlN; ruwfrezen, radiusfrezen, T-gleuf frezen, zwaluwstaartfrezen, schijffrezen, mantelkopfrezen, moduulfrezen, enz.

Wij helpen u graag verder! Zoek niet verder en stuur ons uw mail naar info@vynckier.biz met uw specifieke vraag.

MACH



Roteerfrezen set hardmetaal 8dlg met CB spanenbreker aanslijping.

Troeven:

- Cilindrische schacht ø 6 mm.
- Spanenbreker aanslijping
- Hardmetaal
- Geleverd in een alu koffer met inleg.

Geschikt voor:

- volgende materialen: messing, brons, koper, gietijzer, plastic, staal (60 rc), roestvrij staal tot zelfs Titanium.

Inhoud:

- 2 cilindervormige frezen met kopaanslijping: B102006, B122506
- 2 cilindervormige frezen met radius einde: C061606, C102006
- 2 bolvormige frezen: D100906, D121006
- 2 conische frezen met radius einde: F102006 en F122506.

Afmetingen roteerfrezen:

	L1 (mm)	L2 (mm)	D1 (mm)	D2 (mm)	±CTI (mm)
B102006	64	20	10	6	SB-3M
B122506	69	25	12	6	SB-5M
C061606	68	16	10	6	SC-1M
C102006	64	20	10	6	SC-3M
D100906	33	9	12	6	SD-3M
D121006	35	10,6	10	6	SD-5M
F102006	64	20	12	6	SF-3M
F122506	72	25	6	69	SF-5M

Order nr.	749202000		
Orig. nr.	CBSCB8		
Prijs	€	74,90	



Spiebaanfrezen 2 lippen.



Troeven:

- Industriële spiebaanfrezen
- HSSCo8%
- DIN327D
- Welden schacht
- Aanvalhoek 30°



Te gebruiken bij:

- Staalsoorten enlt; 1000 N/mm², zachte RVS, gietijzer, messing, brons

Verpakt per stuk.

Order nr.	Orig. nr.	Ø1	L1	L2	Ø2	Z	Ge-wicht	Prijs
		mm	mm	mm	mm	mm	kg	€
790630200	SF2L02	2	48	4	6	2	0,10	9,35
790630250	SF2L025	2,5	49	5	6	2	0,10	10,10
790630300	SF2L03	3	49	5	6	2	0,10	9,35
790630350	SF2L035	3,5	50	6	6	2	0,10	10,10
790630400	SF2L04	4	51	7	6	2	0,10	9,35
790630450	SF2L045	4,5	51	7	6	2	0,10	10,10
790630500	SF2L05	5	52	8	6	2	0,10	9,35
790630550	SF2L055	5,5	52	8	6	2	0,10	10,10
790630600	SF2L06	6	52	8	6	2	0,10	9,35
790630650	SF2L065	6,5	60	10	10	2	0,10	14,50
790630700	SF2L07	7	60	10	10	2	0,10	14,50
790630750	SF2L075	7,5	60	10	10	2	0,10	14,50
790630800	SF2L08	8	61	11	10	2	0,10	13,50
790630850	SF2L085	8,5	61	11	10	2	0,10	14,50
790630900	SF2L09	9	61	11	10	2	0,10	14,50
790630950	SF2L095	9,5	61	11	10	2	0,10	14,50
790631000	SF2L10	10	63	13	10	2	0,10	13,50
790631100	SF2L11	11	70	16	12	2	0,10	17,90
790631200	SF2L12	12	73	16	12	2	0,10	19,90
790631300	SF2L13	13	73	16	12	2	0,10	20,70
790631400	SF2L14	14	73	16	12	2	0,10	20,30
790631500	SF2L15	15	73	19	12	2	0,10	24,40
790631600	SF2L16	16	79	19	16	2	0,10	24,80
790631800	SF2L18	18	79	19	16	2	0,10	29,70
790632000	SF2L20	20	88	22	20	2	0,10	35,50
790632200	SF2L22	22	88	22	20	2	0,10	74,00
790632400	SF2L24	24	102	26	25	2	0,10	110,00
790632500	SF2L25	25	102	26	25	2	0,10	110,00
790632600	SF2L26	26	102	26	25	2	0,10	116,00
790632800	SF2L28	28	102	26	25	2	0,10	118,00
790633000	SF2L30	30	102	26	25	2	0,10	130,00

Sneldraaistaal HSS



10-delige set sneldraaistaal.



Troeven:

- Kwaliteit HSS
- Rond/vierkant/rechthoek
- Lengte 100 en 200 mm.

Inhoud:

- Vierkant (4 stuks) 6x6x200, 8x8x200, 10x10x200, 12x12x200 mm
- Rond (3 stuks) 5x100, 8x100, 12x100 mm
- Rechthoekig (3 stuks) 4x8x200, 5x10x200, 6x12x200 mm

Order nr.	790007200		
Orig. nr.	SDS200		
Type	vierkant/rechthoek/rond		
Prijs	€	70,50	

Monoblock vlakfrees



Kopieer- en vlakfrees. "Made in Germany".



Troeven:

- Hoge vlak- en rondloopnauwkeurigheid.
- Freeslichaam met verplaatste verdeling voor een bijzonder rustige loop en gelijkmatige snede.
- Grondlichaam en opspanschacht vormen een eenheid, waardoor kortere afstand spindel-frees en stabiele spanning.
- Er is geen extra freesopnamedoorn nodig.
- Speciale geometrie voor frezen met hoge snelheid.
- Economisch, daar met stompe snijvlakken het plaatje eenvoudig kan worden doorgedraaid. (tot 12 maal bruikbaar).
- Europese makelij

Geschikt voor:

- Universeel gebruik, voor bewerking van alle staal en NE-metalen.
- vlak- en kopieerfrezen.

Geleverd met:

- Monoblock vlakfreeshouder
- 5 snijplaatjes RDET 1003 MOSN 8026 en torxsleutel TX15.

Order nr.	Orig. nr.	Buitendia- meter	Opname- schacht	ISO om- schrijving	Voor machine	Prijs
		mm				€
713350212	M KVF02	52	MK2/M10	RD X.1003	BF20/L	241,00
713350213	M KVF03	52	MK3/M12	RD X.1003	BF30	279,00
713350214	M KVF04	52	MK4/M16	RA1003	MB4P	358,00
713350215	M KVF30	52	ISO30	RD X.1003	BF30	345,00
713350216	M KVF40	63	ISO40	RD X.1003	BF46/MF2-4	345,00



HM vervangplaatjes RDET 1003. MOSN8026.



Troeven:

- Positieve snijgeometrie.
- PVD gecoat.
- 5 stuks.

Geschikt voor:

- bewerking van staal tot 900 N/mm², roestvrij staal, aluminium, non-ferro metaal, gietijzer.
- volgende vlakfrezen (Order nr. 713350212, 713350213, 713350215, 713350216).

Order nr.	713350220	
Orig. nr.	3350220	
Prijs	€	59,90



HM Vervangplaatjes RDHT 1003 MO-FA HF7.



Troeven:

- Gepolierd.
- Met sterk positieve snijgeometrie.
- PVD gecoat.
- 5 stuks.

Geschikt voor:

- bewerking van Al-legering, koperlegering, kunststoffen.
- volgende vlakfrezen (Order nr. 713350212, 713350213, 713350215, 713350216).

Order nr.	713350221	
Orig. nr.	3350221	
Prijs	€	54,50

MACHINES

Opgebraseerde beitels

OPTIMUM



11- delige beitelssets met opgelaste hardmetaalplaatjes.

Troeven:

- Kwaliteit P20/P30.
- Volgens DIN
- Inwendige als uitwendige als rechte draaibeitels
- Linkse en rechtse draaibeitels

Geschikt voor:

- instap draaibeitels
- hobbist

Order nr.	Orig. nr.	Vierkant schacht mm	Prijs €
713441008 M	DBS1108	8	45,50
713441108 M	DBS1110	10	54,90
713441508 M	DBS1116	16	76,50
713441808 M	DBS1120	20	90,90

Set draaibeitels WP

OPTIMUM



5-delige beiteslet 8 mm met HM wisselplaatjes in Aluminium opbergkoffer met inleg.

Troeven :

- 5 uitwendige beitels, waarvan één linkse, één rechte en drie rechtse uitvoeringen
- Iedere beitel uitgerust met een hardmetalen wisselplaat
- Wisselplaten zijn TiN gecoat
- Aluminium opbergkoffer met inleg
- Vierkant 8x8 mm

Geschikt voor :

- Algemeen draaiwerk in gewone staalsoorten
- Iedere draaibank met een vierkants- of snelwisselhouder vanaf 10 mm of meer
- Optimum draaibanken : TU1503V, TU2004V en TU2304

Order nr.	713441662 M
Orig. nr.	DBS0508
Aantal	5
Hoogte H1	8
Prijs	€ 88,50

OPTIMUM



5-delige beitelsset 10 mm met HM wisselplaatjes in Aluminium opbergkoffer met inleg.

Troeven:

- 5 uitwendige beitels, waarvan één linkse, één rechte en drie rechtse uitvoeringen
- Iedere beitel uitgerust met een hardmetalen wisselplaat
- Wisselplaten zijn TiN gecoat
- Aluminium opbergkoffer met inleg
- Vierkant 10x10 mm

Geschikt voor:

- Algemeen draaibank in gewone staalsoorten
- Iedere draaibank met een vierkants- of snelwisselhouder vanaf 12 mm of meer
- Optimum draaibanken: TU2304, TU2404, TU2406, TU2506 en TU2807

Order nr.	713441664 M
Orig. nr.	DBS0510
Aantal	5
Hoogte H1	10
Prijs	€ 99,90

OPTIMUM



Inwendige draaibeitel set.

Troeven:

- 3 inwendige beitels
- Iedere beitel uitgerust met een hardmetalen wisselplaat
- Wisselplaten zijn TiN gecoat
- Aluminium opbergkoffer met inleg
- Vierkant 10x10 mm

Geschikt voor:

- Algemeen draaibank in gewone staalsoorten
- Iedere draaibank met een vierkants- of snelwisselhouder vanaf 12 mm of meer
- Optimum draaibanken: TU2304, TU2404, TU2406, TU2506 en TU2807

Order nr.	713441640 M
Orig. nr.	IWDBS310
Maat	mm 10
Prijs	€ 68,50

OPTI^{lum}



5-delige beitelset 12 mm met HM wisselplaatjes in Aluminium opbergkoffer met inleg.

Troeven:

- 5 uitwendige beitels, waarvan één linkse, één rechte en drie rechte uitvoeringen
- Iedere beitel uitgerust met een hardmetalen wisselplaat
- Wisselplaten zijn TiN gecoat
- Aluminium opbergkoffer met inleg
- Vierkant 12x12 mm

Geschikt voor:

- Algemeen draaibank in gewone staalsoorten
- Iedere draaibank met een vierkants- of snelwisselhouder vanaf 12 mm of meer
- Optimum draaibanken: TU2304, TU2404, TU2406, TU2506 en TU2807

Order nr.	713441666
Orig. nr.	DBS0512
Aantal	5
Hoogte H1	12
Prijs	€ 111,00

OPTIMUM



Inwendige draaibeitel set.

Troeven:

- 3 inwendige beitels
- Iedere beitel uitgerust met een hardmetalen wisselplaat
- Wisselplaten zijn TiN gecoat
- Aluminium opbergkoffer met inleg
- Vierkant 12x12 mm

Geschikt voor:

- Algemeen draaibank in gewone staalsoorten
- Iedere draaibank met een vierkants- of snelwisselhouder vanaf 12 mm of meer
- Optimum draaibanken: TU2304, TU2404, TU2406, TU2506 en TU2807

Order nr.	713441641
Orig. nr.	IWDBS312
Maat	mm 12
Prijs	€ 79,90

OPTI^{lum}



5-delige beitelset 16 mm met HM wisselplaatjes in Aluminium opbergkoffer met inleg.

Troeven:

- 5 uitwendige beitels, waarvan één linkse, één rechte en drie rechte uitvoeringen
- Iedere beitel uitgerust met een hardmetalen wisselplaat
- Wisselplaten zijn TiN gecoat
- Aluminium opbergkoffer met inleg
- Vierkant 16x16 mm

Geschikt voor:

- Algemeen draaien in gewone staalsoorten
- Iedere draaibank met een vierkants- of snelwisselhouder vanaf 16 mm of meer
- Optimum draaibanken: TU3008, TH3309, TH3310, TH4010, D320, D330 en D360

Order nr.	713441668
Orig. nr.	DBS0516
Aantal	5
Hoogte H1	16
Prijs	€ 167,00

OPTIMUM



Aanvullende draaibeitel set bij DBS0516.

Troeven:

- Iedere beitel uitgerust met een hardmetalen wisselplaat
- Wisselplaten zijn TiN gecoat
- Aluminium opbergkoffer met inleg
- Vierkant 16x16 mm

Geschikt voor:

- Algemeen draaien in gewone staalsoorten
- Iedere draaibank met een vierkants- of snelwisselhouder vanaf 16 mm of meer
- Optimum draaibanken: TU3008, TH3309, TH3310, TH4010, D320, D330 en D360

Order nr.	713441610
Orig. nr.	DBHMO516
Aantal	5
Oprname	mm 16
Prijs	€ 148,00

OPTIMUM



Afsteekbeitelhouder AFB16

Troeven :

- Voor het afsteken van allerlei werkstukken op een draaibank.
- Met verschillende afsteekbreedtes 2,2 en 3,1 mm
- Voor het opspannen in vierkantshouders of snelwissel beitelhouders met opnamehoogte van 16 mm.

Geschied voor :

Alle draaibanken met vierkantshouders of snelwissel beitelhouders met opnamehoogte van 16mm.

Geleverd met :

- 1 x Afsteekbeitelhouder SLTBN 16-05
- 1 x Afsteekbeitelmes SLIH 26-2
- 1 x Afsteekbeitelmes SLIH 26-3
- 5 x Afsteekplaatjes GTN2 (afsteekbreedte 2,2 mm)
- 5 x Afsteekplaatjes GTN3 (afsteekbreedte 3,1 mm)
- Aluminium opbergkoffer

Order nr.	713440653		
Orig. nr.	AFB16		
Afsteekbreedte	mm	2,2 / 3,1	
Voor	D320-D330-D360 TH3309-TH3310-TH4010		
Gewicht	kg	3,00	
Prijs	€	156,00	

OPTIMUM



5-delige beitelsset 20 mm met HM wisselplaatjes in Aluminium opbergkoffer met inleg.

Troeven:

- 5 uitwendige beitels, waarvan één linkse, één rechte en drie rechte uitvoeringen
- Iedere beitel uitgerust met een hardmetalen wisselplaat
- Wisselplaten zijn TiN gecoat
- Aluminium opbergkoffer met inleg
- **Vierkant 20x20 mm**

Geschied voor:

- Algemeen draaien in gewone staalsoorten
- Iedere draaibank met een vierkants- of snelwisselhouder vanaf 20 mm of meer
- Optimum draaibanken: D420, TU4210V, TH46-serie

Order nr.	713441670		
Orig. nr.	DBS0520		
Aantal	5		
Prijs	€	195,00	

OPTIMUM



Draaibeitel set aanvullend 20 mm 5 dlg.

Troeven:

- Iedere beitel uitgerust met een hardmetalen wisselplaat
- Wisselplaten zijn TiN gecoat
- Aluminium opbergkoffer met inleg
- **Vierkant 20x20 mm**

Geschied voor:

- Algemeen draaien in gewone staalsoorten
- Iedere draaibank met een vierkants- of snelwisselhouder vanaf 20 mm of meer
- Optimum draaibanken: D420, TU4210V, TH46-serie

Afzonderlijke plaatjes (verpakt per 5 stuks)

No.	ISO	Ordernr.
53	16ER AG60 60° AR	713441703
54/55	RNMM1003MO R	713441702
56/57	VNMG 160408 V/35°	713441701
Order nr.	713441617	
Orig. nr.	DBHMO520	
Prijs	€	177,00

OPTIMUM



Inwendige draadsnij beitel set.

Troeven:

- 5 ISO draadsnij beitels met opnamediameters van respectievelijk 8/10/12/16/20 mm
- Iedere beitel uitgerust met een hardmetalen wisselplaat
- Wisselplaten zijn TiN gecoat
- Aluminium opbergkoffer met inleg

Geschied voor:

- Algemeen draaien in gewone staalsoorten
- Iedere draaibank met een vierkants- of snelwisselhouder vanaf 20 mm of meer
- Optimum draaibanken: D420, TU4210V, TH46-serie

Order nr.	713441650		
Orig. nr.	IDRABS520		
Maat	mm	8-20	
Prijs	€	170,00	

OPTIMUM



Afssteekbeitelhouderset AFB20

Troeven :

- Voor het afsteken van allerlei werkstukken op een draaibank.
- Met verschillende afsteekbreedtes 3,1 en 4,1 mm
- Voor het opspannen in vierkantshouders of snelwissel beitelhouders met opnamehoogte van 20 mm.

Geschikt voor :

- Alle draaibanken met vierkantshouders of snelwissel beitelhouders met opnamehoogte van 20 mm.

Geleverd met :

- 1 x Afssteekbeitelhouder SLTBN 20-05
- 1 x Afssteekbeitelmes SLIH 26-3
- 1 x Afssteekbeitelmes SLIH 26-4
- 5 x Afssteekplaatjes GTN3 (afsteekbreedte 3,1 mm)
- 5 x Afssteekplaatjes GTN4 (afsteekbreedte 4,1 mm)
- Aluminium opbergkoffer

Order nr.	713440654 	
Orig. nr.	AFB20	
Afsteekbreedte	mm	3,1 / 4,1
Voor	D420-D460-TH46-TH56	
Gewicht	kg	4,00
Prijs	€	167,00

OPTIMUM



5-delige beitelsset 25 mm met HM wisselplaatjes in Aluminium opbergkoffer met inleg.

Troeven:

- 5 uitwendige beitels, waarvan één linkse, één rechte en drie rechte uitvoeringen
- Iedere beitel uitgerust met een hardmetalen wisselplaat
- Wisselplaten zijn TiN gecoat
- Aluminium opbergkoffer met inleg
- Vierkant 25x25 mm

Geschikt voor:

- Algemeen draaien in gewone staalsoorten
- Iedere draaibank met een vierkants- of snelwisselhouder vanaf 25 mm of meer
- Optimum draaibanken: TH4610, TH4615, TH4620, TH4615V

Order nr.	713441672 	
Orig. nr.	DBS0525	
Aantal	5	
Prijs	€	230,00

OPTIMUM



Aanvullende draaibeitel set bij 713441672.

Bestaande uit:

- 5 ISO beitelhouders hoogte 25 mm
- In een degelijke afsluitbare alu koffer met inleg.

Geschikt voor:

- Voor gebruik met ISO snijplaten

Draaibeitels

46	MVVNN 2525 M16
47	SER 2525 M16
48	PRGNN 2525 M12
49	PRANN 2525 M16
50	MVJNR 2525 M16

Order nr.	713441623 	
Orig. nr.	DBHM0525	
Prijs	€	212,00

OPTIMUM



Afssteekbeitelhouderset AFB25

Troeven :

- Voor het afsteken van allerlei werkstukken op een draaibank.
- Met verschillende afsteekbreedtes 3,1 en 4,1 mm
- Voor het opspannen in vierkantshouders of snelwissel beitelhouders met opnamehoogte van 25 mm.

Geschikt voor :

- Alle draaibanken met vierkantshouders of snelwissel beitelhouders met opnamehoogte van 25 mm.

Geleverd met :

- 1 x Afssteekbeitelhouder SLTBN 25-05
- 1 x Afssteekbeitelmes SLIH 26-3
- 1 x Afssteekbeitelmes SLIH 26-4
- 5 x Afssteekplaatjes GTN3 (afsteekbreedte 3,1 mm)
- 5 x Afssteekplaatjes GTN4 (afsteekbreedte 4,1 mm)
- Aluminium opbergkoffer

Order nr.	713440655 	
Orig. nr.	AFB25	
Afsteekbreedte	mm	3,1 / 4,1
Voor	D660 TU8020 TU8030	
Gewicht	kg	5,00
Prijs	€	178,00

OPTIMUM



5-delige beitset 32 mm met HM wisselplaatjes in Aluminium opbergkoffer met inleg.

Troeven:

- 5 uitwendige beitels, waarvan één linkse, één rechte en drie rechtse uitvoeringen
- Iedere beitel uitgerust met een hardmetalen wisselplaat
- Wisselplaten zijn TiN gecoat
- Aluminium opbergkoffer met inleg
- **Vierkant 32x32 mm**

Geschikt voor:

- Algemeen draaien in gewone staalsoorten
- Iedere draaibank met een vierkants- of snelwisselhouder vanaf 32 mm of meer
- Optimum draaibanken: D560-serie, TH56-serie, D660-serie, TU80-serie

Order nr.	713441674
Orig. nr.	DBS0532
Aantal	5
Prijs	€ 299,00

Wisselplaten

OPTIMUM



In- en uitwendige ruitvormige snijplaat CCMT060204

Troeven:

- Hardmetalen snijplaten met TiN coating
- TiN = Titanium Nitride. Dit is een bescherm laag, die de warmteontwikkeling beperkt en de levensduur van de snijplaat aanzienlijk verlengt.
- Snijplaten kunnen gedraaid worden, meerdere malen inzetbaar
- Volgens ISO
- Verpakt per 5 stuks

Geschikt voor:

- voor algemeen draaiwerk in staal

Komt voor in:

- vorige draaibeitelset DBHM0708 (713441011) - beitel 2, 5
- vorige draaibeitelset DBHM0710 (713441111) - beitel 9, 12
- vorige draaibeitelset DBHM0716 (713441511) - beitel 29
- Draaibeitelset IWDBS310 (713441640) - beitel 61
- Draaibeitelset IWDBS312 (713441641) - beitel 61

Order nr.	713441164
Orig. nr.	3441164
l	6,35
s	2,6
r	0,4
d	6,35
d1	2,7
Prijs	€ 64,90

OPTIMUM

In- en uitwendige ruitvormige snijplaat DCMT070204



Troeven:

- Hardmetalen snijplaten met TiN coating
- TiN = Titanium Nitride. Dit is een bescherm laag, die de warmteontwikkeling beperkt en de levensduur van de snijplaat aanzienlijk verlengt.
- Snijplaten kunnen gedraaid worden, meerdere malen inzetbaar
- Volgens ISO
- Verpakt per 5 stuks

Geschikt voor:

- voor algemeen draaiwerk in staal

Komt voor in:

- Draaibeitelset DBS0508 (713441662) - beitel 5
- Draaibeitelset DBS0510 (713441664) - beitel 10
- Draaibeitelset DBS0512 (713441666) - beitel 15
- Draaibeitelset IWDBS310 (713441640) - beitel 63
- Draaibeitelset IWDBS312 (713441641) - beitel 63
- Vorige draaibeitelset DBHM0708 (713441011) - beitel 3 en 4
- Vorige draaibeitelset DBHM0710 (713441111) - beitel 10 en 11
- Identiek aan 713441166

Order nr.	713441758
Orig. nr.	3441758
Beitelnummer	5/10/15
ISO	DCMT070204
D1	mm 6,35
D2	mm 2,8
B1	° 55
S1	mm 2,38
Re	mm 0,4
Gewicht	kg 0,10
Afmetingen (l x b x h)	mm 100 x 50 x 30
Prijs	€ 29,50

OPTIMUM

Snijplaatjes ISO DNMG110408. Verpakking 5 stuks.



Troeven:

- Hardmetalen snijplaten met TiN coating
- TiN = Titanium Nitride. Dit is een bescherm laag, die de warmteontwikkeling beperkt en de levensduur van de snijplaat aanzienlijk verlengt.
- Snijplaten kunnen gedraaid worden, meerdere malen inzetbaar
- Volgens ISO
- Verpakt per 5 stuks



Geschikt voor:

- voor algemeen draaiwerk in staal

Komt voor in:

- Draaibeitelset DBS0516 (713441668) - beitel 25
- Draaibeitelset DBS0520 (713441670) - beitel 40

Order nr.	713441750
Orig. nr.	DNMG110408
ISO	DNMG110408
D1	mm 9,525
D2	mm 3,81
B1	° 55
S1	mm 4,76
Re	mm 0,8
Gewicht	kg 0,10
Afmetingen (l x b x h)	mm 100 x 50 x 30
Prijs	€ 45,50

OPTI^{lum}



Snijplaatjes ISO DNMG150408. Verpakking 5 stuks.

Troeven:

- Hardmetalen snijplaten met TiN coating
- TiN = Titanium Nitride. Dit is een bescherm laag, die de warmteontwikkeling beperkt en de levensduur van de snijplaat aanzienlijk verlengt.
- Snijplaten kunnen gedraaid worden, meerdere malen inzetbaar
- Volgens ISO
- Verpakt per 5 stuks

Geschikt voor:

- voor algemeen draaiwerk in staal

Komt voor in:

- Draaibeitelset DBS0525 (713441672) - beitel 55
- Draaibeitelset DBS0532 (713441674) - beitel 60

Order nr.	713441751	
Orig. nr.	3441751	
ISO	DNMG150408	
D1	mm	12,7
D2	mm	5,16
B1	°	55
S1	mm	4,76
Re	mm	0,8
Gewicht	kg	0,10
Afmetingen (l x b x h)	mm	100 x 50 x 30
Prijs	€	45,50

OPTI^{lum}



Snijplaatjes ISO KNUX160405R. Verpakking 5 stuks.

Troeven:

- Hardmetalen snijplaten met TiN coating
- TiN = Titanium Nitride. Dit is een bescherm laag, die de warmteontwikkeling beperkt en de levensduur van de snijplaat aanzienlijk verlengt.
- Snijplaten kunnen gedraaid worden, meerdere malen inzetbaar
- Volgens ISO
- Verpakt per 5 stuks

Geschikt voor:

- voor algemeen draaiwerk in staal

Komt voor in:

- Draaibeitelset DBS0516 (713441668) - beitel 24
- Draaibeitelset DBS0520 (713441670) - beitel 39
- Draaibeitelset DBS0525 (713441672) - beitel 54
- Draaibeitelset DBS0532 (713441674) - beitel 59

Order nr.	713441754	
Orig. nr.	KNUX160405R	
ISO	KNUX160405R	
D1	mm	9,252
B1	°	55
S1	mm	4,76
Re	mm	0,8
Gewicht	kg	0,10
Afmetingen (l x b x h)	mm	100 x 50 x 30
Prijs	€	40,90

OPTI^{lum}



Rond snijplaatje. R TiN gecoated ISO: RNMM1003MO. Verpakking 5 stuks.

Troeven:

- Hardmetalen snijplaten met TiN coating
- TiN = Titanium Nitride. Dit is een bescherm laag, die de warmteontwikkeling beperkt en de levensduur van de snijplaat aanzienlijk verlengt.
- Snijplaten kunnen gedraaid worden, meerdere malen inzetbaar
- Volgens ISO
- Verpakt per 5 stuks

Geschikt voor:

- voor algemeen draaiwerk in staal

Komt voor in:

- draaibeitelset DBHM0516 (713441610) beitel 32 en 34
- draaibeitelset DBHM0520 (713441617) beitel 42 en 43

Order nr.	713441702	
Orig. nr.	RNMM1003MO-R	
D1	mm	10
D2	mm	3,6
S1	mm	3,97
Gewicht	kg	0,10
Afmetingen (l x b x h)	mm	100 x 50 x 30
Prijs	€	33,50

OPTI^{lum}



Rond snijplaatje. R TiN gecoated ISO: RNMG1204MO. Verpakking 5 stuks.

Troeven:

- Hardmetalen snijplaten met TiN coating
- TiN = Titanium Nitride. Dit is een bescherm laag, die de warmteontwikkeling beperkt en de levensduur van de snijplaat aanzienlijk verlengt.
- Snijplaten kunnen gedraaid worden, meerdere malen inzetbaar
- Volgens ISO
- Verpakt per 5 stuks

Geschikt voor:

- voor algemeen draaiwerk in staal

Komt voor in:

- Draaibeitelset DBHM0525 (713441623) - beitel 48

Order nr.	713441705	
Orig. nr.	3441705	
D1	mm	12
D2	mm	4,75
B1	°	R
S1	mm	5,1
Gewicht	kg	0,10
Afmetingen (l x b x h)	mm	100 x 50 x 30
Prijs	€	33,50

OPTI^{lum}



Rond Snijplaatje. R TiN coated ISO:
RNMG1605MO. Verpakking 5 stuks.

Troeven:

- Hardmetalen snijplaten met TiN coating
- TiN = Titanium Nitride. Dit is een bescherm laag, die de warmteontwikkeling beperkt en de levensduur van de snijplaat aanzienlijk verlengt.
- Snijplaten kunnen gedraaid worden, meerdere malen inzetbaar
- Volgens ISO
- Verpakt per 5 stuks

Geschikt voor:

- voor algemeen draaiwerk in staal

Komt voor in:

- Draaibeitelset DBHM0525 (71 344 1623) - beitel 49

Order nr.	713441704
Orig. nr.	3441704
Prijs	€ 56,90

OPTI^{lum}

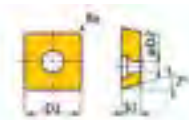

Uitwendige vierkante snijplaat
SCMT060204

Troeven:

- Hardmetalen snijplaten met TiN coating
- TiN = Titanium Nitride. Dit is een bescherm laag, die de warmteontwikkeling beperkt en de levensduur van de snijplaat aanzienlijk verlengt.
- Snijplaten kunnen gedraaid worden, meerdere malen inzetbaar
- Volgens ISO
- Verpakt per 5 stuks

Geschikt voor:

- voor algemeen draaiwerk in staal

Komt voor in:

- Draaibeitelset DBS0508 - beitel 2
- Draaibeitelset DBS0510 - beitel 7

Order nr.	713441761
Orig. nr.	3441761
Beitelnummer	2/7
ISO	SCMT060204
D1	mm 6,35
D2	mm 2,8
B1	° 90
S1	mm 2,38
Re	mm 0,4
Gewicht	kg 0,10
Afmetingen (l x b x h)	mm 100 x 50 x 30
Prijs	€ 29,50

OPTI^{lum}

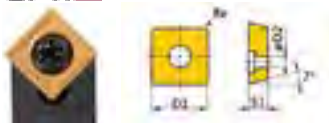

Uitwendige vierkante snijplaat SCMT09T304

Troeven:

- Hardmetalen snijplaten met TiN coating
- TiN = Titanium Nitride. Dit is een bescherm laag, die de warmteontwikkeling beperkt en de levensduur van de snijplaat aanzienlijk verlengt.
- Snijplaten kunnen gedraaid worden, meerdere malen inzetbaar
- Volgens ISO
- Verpakt per 5 stuks

Geschikt voor:

- voor algemeen draaiwerk in staal

Komt voor in:

- Draaibeitelset DBS0512 - beitel 12
- Vorige draaibeitelset DBHM0716 (71 344 1511) - beitel 30 / 31

Order nr.	713441763
Orig. nr.	SCMT09T304
ISO	SCMT09T304
D1	mm 6,35
D2	mm 2,8
S1	mm 2,38
Re	mm 0,4
Gewicht	kg 0,10
Afmetingen (l x b x h)	mm 100 x 50 x 30
Prijs	€ 33,50

OPTI^{lum}

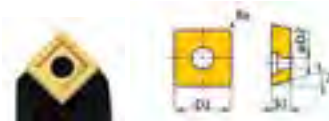

Snijplaatjes ISO SNMG090304. Verpakking 5 stuks.

Troeven:

- Hardmetalen snijplaten met TiN coating
- TiN = Titanium Nitride. Dit is een bescherm laag, die de warmteontwikkeling beperkt en de levensduur van de snijplaat aanzienlijk verlengt.
- Snijplaten kunnen gedraaid worden, meerdere malen inzetbaar
- Volgens ISO
- Verpakt per 5 stuks

Geschikt voor:

- voor algemeen draaiwerk in staal

Komt voor in:

- Draaibeitelset DBS0516 (71 344 1668) - beitel 23

Order nr.	713441755
Orig. nr.	SNMG090304
ISO	SNMG090304
D1	mm 9,252
D2	mm 3,81
B1	° 90
S1	mm 3,18
Re	mm 0,4
Gewicht	kg 0,10
Afmetingen (l x b x h)	mm 100 x 50 x 30
Prijs	€ 33,50

OPTI^{lum}



Snijplaatjes ISO SNMG120408. Verpakking 5 stuks.

Troeven:

- Hardmetalen snijplaten met TiN coating
- TiN = Titanium Nitride. Dit is een bescherm laag, die de warmteontwikkeling beperkt en de levensduur van de snijplaat aanzienlijk verlengt.
- Snijplaten kunnen gedraaid worden, meerdere malen inzetbaar
- Volgens ISO
- Verpakt per 5 stuks

Geschikt voor:

- voor algemeen draaiwerk in staal

Komt voor in:

- Draaibeitelset DBS0520 (713441670) - beitel 38

Order nr.	713441756		
Orig. nr.	3441756		
ISO	SNMG120408		
D1	mm	12,7	
D2	mm	5,16	
B1	°	90	
S1	mm	4,76	
Re	mm	0,8	
Gewicht	kg	0,10	
Afmetingen (l x b x h)	mm	100 x 50 x 30	
Prijs	€	45,50	

OPTI^{lum}

Uitwendige driehoekige snijplaat
TCMT090204

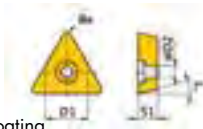

Troeven:

- Hardmetalen snijplaten met TiN coating
- TiN = Titanium Nitride. Dit is een bescherm laag, die de warmteontwikkeling beperkt en de levensduur van de snijplaat aanzienlijk verlengt.
- Snijplaten kunnen gedraaid worden, meerdere malen inzetbaar
- Volgens ISO
- Verpakt per 5 stuks

Geschikt voor:

- voor algemeen draaiwerk in staal

Komt voor in:

- Draaibeitelset DBS0508 - beitel 4
- Draaibeitelset DBS0510 - beitel 9

Order nr.	713441760		
Orig. nr.	3441760		
Beitelnummer	4/9		
ISO	TCMT090204		
D1	mm	5,56	
D2	mm	2,5	
B1	°	60	
S1	mm	2,38	
Re	mm	0,4	
Gewicht	kg	0,10	
Afmetingen (l x b x h)	mm	100 x 50 x 30	
Prijs	€	29,50	

OPTI^{lum}



Uitwendige / inwendige driehoekige snijplaat TCMT110204

Troeven:

- Hardmetalen snijplaten met TiN coating
- TiN = Titanium Nitride. Dit is een bescherm laag, die de warmteontwikkeling beperkt en de levensduur van de snijplaat aanzienlijk verlengt.
- Snijplaten kunnen gedraaid worden, meerdere malen inzetbaar
- Volgens ISO
- Verpakt per 5 stuks

Geschikt voor:

- voor algemeen draaiwerk in staal

Komt voor in:

- Draaibeitelset DBS0512 - beitel 14
- Inwendige draaibeitelset IWDBS310 - beitel 64
- Inwendige draaibeitelset IWDBS312 - beitel 64

Order nr.	713441762		
Orig. nr.	3441762		
Beitelnummer	14		
ISO	TCMT110204		
D1	mm	6,35	
D2	mm	2,8	
B1	°	60	
S1	mm	2,38	
Re	mm	0,4	
Gewicht	kg	0,10	
Afmetingen (l x b x h)	mm	100 x 50 x 30	
Prijs	€	29,50	

OPTI^{lum}



Snijplaatje. V/35° TiN gecoated ISO: VNMG160408.
Verpakking 5 stuks.

Troeven:

- Hardmetalen snijplaten met TiN coating
- TiN = Titanium Nitride. Dit is een bescherm laag, die de warmteontwikkeling beperkt en de levensduur van de snijplaat aanzienlijk verlengt.
- Snijplaten kunnen gedraaid worden, meerdere malen inzetbaar
- Volgens ISO
- Verpakt per 5 stuks

Geschikt voor:

- voor algemeen draaiwerk in staal

Komt voor in:

- draaibeitelset DBHM0516 (713441610) beitel 31 en 33
- draaibeitelset DBHM0520 (713441617) beitel 44 en 45
- draaibeitelset DBHM0525 (713441623) beitel 46 en 50

Order nr.	713441701		
Orig. nr.	VNMG160408		
D1	mm	9,525	
D2	mm	3,81	
B1	°	35	
S1	mm	4,76	
Re	mm	0,8	
Gewicht	kg	0,10	
Afmetingen (l x b x h)	mm	100 x 50 x 30	
Prijs	€	40,90	

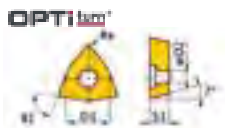

Uitwendige snijplaat WCMT050308

Troeven:

- Hardmetalen snijplaten met TiN coating
- TiN = Titanium Nitride. Dit is een bescherm laag, die de warmteontwikkeling beperkt en de levensduur van de snijplaat aanzienlijk verlengt.
- Snijplaten kunnen gedraaid worden, meerdere malen inzetbaar
- Volgens ISO
- Verpakt per 5 stuks

Geslacht voor:

- voor algemeen draaiwerk in staal

Komt voor in:

- Draaibeitelset DBS0508 - beitel 1 en 3
- Draaibeitelset DBS0510 - beitel 6 en 8
- Draaibeitelset DBS0512 - beitel 11 en 13

Order nr.	713441759	
Orig. nr.	3441759	
Beitelnummer	1/3/6/8/11/13	
ISO	WCMT050308	
D1	mm	7,94
D2	mm	3,2
B1	°	80
S1	mm	3,18
Re	mm	0,8
Gewicht	kg	0,10
Afmetingen (l x b x h)	mm	100 x 50 x 30
Prijs	€	33,50



Snijplaatjes ISO WNMG080408. Verpakking 5 stuks.

Troeven:

- Hardmetalen snijplaten met TiN coating
- TiN = Titanium Nitride. Dit is een bescherm laag, die de warmteontwikkeling beperkt en de levensduur van de snijplaat aanzienlijk verlengt.
- Snijplaten kunnen gedraaid worden, meerdere malen inzetbaar
- Volgens ISO
- Verpakt per 5 stuks

Geslacht voor:

- voor algemeen draaiwerk in staal

Komt voor in:

- Draaibeitelset DBS0516 (713441668)- beitel 21 en 22

Order nr.	713441753	
Orig. nr.	3441753	
ISO	WNMG080408	
D1	mm	9,252
D2	mm	3,81
B1	°	80
S1	mm	4,76
Re	mm	0,8
Gewicht	kg	0,10
Afmetingen (l x b x h)	mm	100 x 50 x 30
Prijs	€	45,50



Snijplaatjes ISO WNMG080408. Verpakking 5 stuks.

Troeven:

- Hardmetalen snijplaten met TiN coating
- TiN = Titanium Nitride. Dit is een bescherm laag, die de warmteontwikkeling beperkt en de levensduur van de snijplaat aanzienlijk verlengt.
- Snijplaten kunnen gedraaid worden, meerdere malen inzetbaar
- Volgens ISO
- Verpakt per 5 stuks

Geslacht voor:

- voor algemeen draaiwerk in staal

Komt voor in:

- Draaibeitelset DBS0520 (713441670) - beitel 36 en 37
- Draaibeitelset DBS0525 (713441672) - beitel 51 en 53
- Draaibeitelset DBS0532 (713441674) - beitel 56 en 58

Order nr.	713441752	
Orig. nr.	WNMG080408	
ISO	WNMG060408	
D1	mm	9,252
D2	mm	3,81
B1	°	80
S1	mm	4,76
Re	mm	0,8
Gewicht	kg	0,10
Afmetingen (l x b x h)	mm	100 x 50 x 30
Prijs	€	45,50



Afsteekplaatjes voor set AFB16, AFB20 en AFB25. Verpakt per 10 stuks

Troeven:

- Verschillende afsteekbreedtes
- Hardmetalen snijplaten met TiN coating
- TiN = Titanium Nitride. Dit is een bescherm laag, die de warmteontwikkeling beperkt en de levensduur van de snijplaat aanzienlijk verlengt.
- Snijplaten kunnen gedraaid worden, meerdere malen inzetbaar
- Volgens ISO
- Verpakt per 10 stuks

Geslacht voor:

- voor algemeen draaiwerk in staal

Order nr.	713440663	713440664	713440665	
Orig. nr.	GTN2	GTN3	GTN4	
Afsteekbreedte	mm	2,2	3,1	4,1
Voor	AFB16	AFB16-20-25	AFB20-25	
Gewicht	kg	0,50	0,50	0,50
Prijs	€	61,50	61,50	73,50

OPTI lum



Draadsnijplaatje ISO 08IR A60 60° IR - TiN gecoat

Troeven:

- Hardmetalen snijplaten met TiN coating
- TiN = Titanium Nitride. Dit is een bescherm laag, die de warmteontwikkeling beperkt en de levensduur van de snijplaat aanzienlijk verlengt.
- Snijplaten kunnen gedraaid worden, meerdere malen inzetbaar
- Volgens ISO
- Verpakt per 5 stuks

Geschiedt voor:

- voor algemeen draaiwerk in staal

Komt voor in:

- Draaibeitelset IDRABS520 (713441650) - beitel 64

Order nr.	713441725
Orig. nr.	08IR A60
l	8
s	2.22
d	4.76
d1	2.5
Prijs	€ 63,50

OPTI lum



Draadsnijplaatje ISO 11IR A60 60° IR - TiN gecoat - Verpakt per 5 stuks

Troeven:

- Hardmetalen snijplaten met TiN coating
- TiN = Titanium Nitride. Dit is een bescherm laag, die de warmteontwikkeling beperkt en de levensduur van de snijplaat aanzienlijk verlengt.
- Snijplaten kunnen gedraaid worden, meerdere malen inzetbaar
- Volgens ISO
- Verpakt per 5 stuks

Geschiedt voor:

- voor algemeen draaiwerk in staal

Komt voor in:

- Draaibeitelset IDRABS520 (713441650) - beitel 65 en 66

Order nr.	713441726
Orig. nr.	11IR A60
Prijs	€ 63,50

OPTI lum



Draadsnijplaatje. 60° AR TiN gecoated ISO: 16ERAG60. Verpakking 5 stuks.

Troeven:

- Hardmetalen snijplaten met TiN coating
- TiN = Titanium Nitride. Dit is een bescherm laag, die de warmteontwikkeling beperkt en de levensduur van de snijplaat aanzienlijk verlengt.
- Snijplaten kunnen gedraaid worden, meerdere malen inzetbaar
- Volgens ISO
- Verpakt per 5 stuks

Geschiedt voor:

- voor algemeen draaiwerk in staal

Komt voor in:

- draaibeitelset DBHM0516 (713441610) beitel 35
- draaibeitelset DBHM0520 (713441617) beitel 41
- draaibeitelset DBHM0525 (713441623) beitel 47

Order nr.	713441703
Orig. nr.	3441703
Prijs	€ 56,90

OPTI lum



Draadsnijplaatje ISO 16IR A60 60° IR - TiN gecoat - verpakt per 5 stuks

Troeven:

- Hardmetalen snijplaten met TiN coating
- TiN = Titanium Nitride. Dit is een bescherm laag, die de warmteontwikkeling beperkt en de levensduur van de snijplaat aanzienlijk verlengt.
- Snijplaten kunnen gedraaid worden, meerdere malen inzetbaar
- Volgens ISO
- Verpakt per 5 stuks

Geschiedt voor:

- voor algemeen draaiwerk in staal

Komt voor in:

- Draaibeitelset IDRABS520 (713441650) - beitel 67 en 68

Order nr.	713441727
Orig. nr.	16IR A60
l	16
s	3.65
d	9.5
d1	3.95
Prijs	€ 63,50

MACHINES

Machine oliën



Tandwielolie - 5l.

Helios 5 is een hoge druk tandwielolie met antislijtage eigenschappen voor de smering van tandwieloverbrengingen met carter.

Toepassingsgebied:

- Tandwielkasten
- Industriële reductoren;
- Reductoren en keerkoppelingen (marine);
- Transmissiekettingen in oliebak
- Zeer traag of met interval werkende lagere die met olie worden gesmeerd
- Zwaar belaste lagere

Kenmerken:

- Kinematische viscositeit bij 40°C: 151cst
- Vlampunt 262°C
- Bevat noch chloor noch lood

Tip: MSDS fiche voor professionelen beschikbaar op onze website

Order nr.	790030020
Orig. nr.	HELIOS 5
Index viscositeit	150
Inhoud	5
Prijs	€ 41,90



Leibaanolie - 5l

Glide 5 is een smeermiddel van hoge kwaliteit voor de smering van leibanen van werktuigmachines. Viscositeit 68.

Troeven:

- Uitzonderlijk hechtings- en uiterst druk vermogen
- Sterke afscheiding bij contact met metaalbewerkingsvloeistoffen
- Neutraal tov wel of niet beklede leibanen
- Op minerale basis met specifieke additieven
- Volledig compatibel met rubberen dichtingen

Toepassingsgebied:

- smering van leibanen, bewegingen die onder zware belasting staan en bij lage snelheden de optimale precisie helpen uitvoeren

Kenmerken:

- Kinematische viscositeit bij 40°C: 68 lcs
- Vlampunt 224°C

Tip: MSDS fiche voor professionelen beschikbaar op onze website.

Order nr.	790030030
Orig. nr.	GLIDE 5
Index viscositeit	68
Prijs	€ 33,90



Hydraulische olie 5l of 60L

Hydro 46 5 is een hydraulische olie ontwikkeld voor hydraulische systemen met verhoogde anti-slijtage additieven voor allround gebruik. Viscositeit 46.



Troeven:

- allrounder voor het werken onder de zwaarste omstandigheden van druk en temperatuur.
- Zeer goede smering door het sterk desemulgerend vermogen.
- Een goede thermische stabiliteit en hoge oxidatieweerstand.
- Een goede filterbaarheid.
- Goede ontluchting en anti-schuimeigenschappen.
- Een perfect antislijtagevermogen.

Toepassingsgebied:

- persen
- hydraulische systemen en circuits van mobiel materiaal
- smeren van middelmatig belaste tandwielkasten met rechte vertanding

Kenmerken:

- Kinematische viscositeit bij 40°C: 481cst
- Vlampunt 230°C

Tip: MSDS fiche voor professionelen beschikbaar op onze website

Order nr.	790030046	790030048
Orig. nr.	HYDRO 46 5	HYDRO 46 60
Index viscositeit	46	46
Inhoud	5	60
Prijs	€ 24,50	191,00



Hydraulische olie 32 - 5l.

Geschikt voor:

- Een hoogwaardige hydraulische olie, aanbevolen voor hydraulische systemen en tandwielkasten dat dienen te werken onder veeleisende condities.



Kenmerken:

- De olie heeft een breed werkspectrum in temperatuursbereik en werd ontworpen om de Scandinavische winters te overbruggen.
- Deze hydraulische olie voldoet en overtreft de gebruiker zijn vereisten op hoog geavanceerd hydraulische systemen.
- Filter gerelateerde problemen kunnen vermeden worden door deze olie en komen ook de bedrijfszekerheid ten goede.
- De levensduur van het ganse systeem verlengt en draagt bij tot een verlenging van de wisseltijden.
- MSDS fiches zijn voor professionele gebruikers beschikbaar en op aanvraag.
- In verpakking van 5 liter.

Order nr.	155420102
Orig. nr.	HYDOIL 32 HVI-5L
Viscositeit bij 40°C	mm ² /s 29,0
Viscositeit bij 100°C	mm ² /s 6,1
Index viscositeit	165
Inhoud	5
Prijs	€ 48,50



Minerale compressor olie - 1l.

Geschikt voor:

- Alle mobiele en stationaire zuiger- en schroefcompressoren waar een olie met een hoge viscositeit wordt aanbevolen.

Kenmerken:

- Universele olie met een breed werkspectrum.
- Met additieven die slijtage, corrosie en oxidatie voorkomen.
- De olie houdt de motor net van afzettingen en residuele afzettingen, hierdoor verlengt de levensduur van de motor en vermindert het risico van smering gerelateerde breuk aanzienlijk.
- MSDS fiche voor professionele gebruikers beschikbaar en op aanvraag.

Order nr.	155320104	
Orig. nr.	COMPOIL SAE30-1L	
Viscositeit bij 40°C	mm ² /s	98
Viscositeit bij 100°C	mm ² /s	10,5
Index viscositeit		105
Inhoud	l	1
Prijs	€	11,90



Pneumatische olie - 1l - 5l.

Geschikt voor:

- Deze olie is zeer geschikt voor pneumatische toestellen.

Kenmerken

- Aanbevelen voor industrie en diverse toepassingen.
- Olie is bruikbaar in temperaturen tussen -25° en 70°.
- Deze pneumatische olie heeft betere resultaten tegen slijtage in vergelijking met de traditionele vernevelingsoliën.
- MSDS fiche voor professionelen beschikbaar en op aanvraag.

Order nr.	155310105	155310303
Orig. nr.	AIRTOIL 22-1L	AIRTOIL 22-5L
Viscositeit bij 40°C	mm ² /s	22
Viscositeit bij 100°C	mm ² /s	4,2
Index viscositeit		80
Inhoud	l	5
Prijs	€	14,90

Koel- & snijolie



Koelmiddel concentraat - 5l.

Een biostabiele emulsie met een uitstekend koel- en smeervermogen.

Kenmerken:

- Bevat uitstekende anti-roest, anti-corrosie en anti-schuim eigenschappen.
- Amine- en chloorvrij.
- Aanvending: het smeren / koelen van alle bewerkingen op ferro- en non-ferrometalen.
- Vertoont een goede mengbaarheid met hard water.
- Onschadelijk voor de huid en is niet agressief t.o.v. machineonderdelen.
- Kleur: melkachtig wit

Toepassingsgebied:

- Boren
- Tappen
- Draaien
- Ruimen
- Frezen
- Zagen

Zowel op conventionele als CNC machines.

Concentratie:

- Voor de gangbare verspanende bewerkingen: 5%.
- Voor moeilijke verspanende bewerkingen: 6 tot 10%.

Bereiding van de emulsie:

- De emulsies worden bereid door het concentraat al roerend toe te voegen aan het water (niet omgekeerd).

Order nr.	790030005	
Orig. nr.	NEPTUNUS 5	
Viscositeit bij 40°C	mm ² /s	70,7
Inhoud	l	5
Prijs	€	47,50



Snijolie voor verspanende bewerkingen op allerlei staalsoorten - 5l.

Dankzij een labo ontwikkelde toevoeging kan deze olie aangewend worden voor de smering van moeilijke bewerkingen, zowel bij hoge als bij lage snelheden.



Toepassingsgebied:

- Boren
- Tappen
- Draaien
- Ruimen
- Frezen
- Zagen

Zowel op conventionele als CNC machines.

Voordelen:

- Helder en bijna reukloos
- Anti-mist
- Multifunctioneel

Concentratie:

- Puur te gebruiken
- Snijolie is niet oplosbaar in water of een emulgeerbaar (koelmelk) product.

Order nr.		790030010
Orig. nr.		CUTEDGE 5
Inhoud	l	5
Prijs	€	58,90



Vernevelolie met een hoog prestatieniveau - 5l.

Geschikt voor:

- Een uitstekende smering en bescherming van de gereedschappen verzekert voor gelegerd- en roestvrij staal (geen gele metalen).



Troeven:

- Schoonhouden van de machine tov koelmelk
- Uitzonderlijke oppervlakteafwerking
- Door verhoogde smedigheid en uiterstdruk eigenschappen bekomt men een zeer goede smering van gereedschappen in een breed toerentalbereik
- Onschadelijk voor de gebruiker
- Biologisch afbreekbaar

Toepassingsgebied:

- Op alle vernevelapparaten
- Boren
- Afsteken
- Tappen
- Zagen
- Automaat draaien

Order nr.		790030015
Orig. nr.		NEBULA 5
Viscositeit bij 40°C	mm ² /s	50
Inhoud	l	5
Densiteit bij 15°C	kg/m ³	940
Prijs	€	52,50



Aluminium snijwas.

Geschikt voor:

- Snijwas voor non-ferro metalen zoals aluminium, koper of messing.

Troeven:

- De was blijft aan het werktuig gehecht, ideaal voor gebruik in moeilijk bereikbare plaatsen.
- Verleng de levensduur aanzienlijk van uw dure hardmetaal belegde cirkelzaagbladen door de alu stick te gebruiken.
- Chloorvrij.



Order nr.		713601763
Orig. nr.		387601200
Inhoud	g	350
Prijs	€	10,90



Spuitbus snijolie 'Aerosol Metcutspray' - 500ml.

Geschikt voor:

- Snijnspray inzetbaar bij het verspanen van alle soorten metalen en ook non-ferro metalen.

Troeven:

- Biologisch afbreekbaar volgens CEC-L-33-T82.
- Zonder drijfgas door handpomp spray.
- Inhoud 500 ml.



Order nr.		713601762
Orig. nr.		METUT050
Inhoud	ml	500
Prijs	€	13,50



Polierwas in algemene toepassing - 2 x 120 g

Bestaat uit:

- Slijpwas
- Polierwas



Geschikt voor:

- Poliermolen

Order nr.		71421002
Orig. nr.		71421002
Prijs	€	15,90

Koelinrichting



Flexibele kunststof koelmiddelslang.

Troeven:

- Degelijke flexibele kunststof elementen
- Geen extern verlies van koelmiddel doorheen de elementen.
- Verschillende aansluitingen mogelijk

Standaard geleverd met:

- 2 x lengtes van 140 mm
- meerdere ronde spuitmonden

Order nr.	891565382	891565383	891565384
Orig. nr.	40413	50813	60513
Lengte	mm 2x140	2x140	2x140
Aansluiting	inch 1/4 - 1/8	3/8 - 1/2	3/4
Ronde spuitmonden	mm 1,5 - 3 - 6	6 - 9 - 12	16 - 19
Prijs	€ 16,30	19,20	25,50

OPTIMUM

Dubbele flexibele kunststof koelvloeistofslang op magneetvoet.

Geschikt voor:

- Niet roestend en resistent aan de meeste oplosmiddelen en chemicaliën.
- Universeel toepasbaar op alle metaalbewerkingsmachines.



Bestaande uit:

- Grootte magnetische voet (lxbxh) 60x50x55 mm
- Treksterkte 50 kg.
- Twee flexibele slangen lengte 300 mm.

Order nr.	713356660
Orig. nr.	DFK
Lengte	mm 335
Prijs	€ 58,90

OPTIMUM

Koelvloeistofvernevelaar MMC1.

Troeven:

- Door het vernevelen van vloeistof kan u veel gericht werken en werkt u netter in de werkplaats.

Bestaande uit:

- Grootte magnetische voet (lxBxH) 62x50x55,5 mm.
- Treksterkte 75 kg.
- Flexibele slang lengte 500 mm.
- Aparte vernevelolie 713606002, deze kunt u ook gebruiken voor microdoseersystemen.

Tip: luchtdruk noodzakelijk.

Order nr.	713356663
Orig. nr.	MMC1
Prijs	€ 126,00

OPTIMUM



Universele koelinrichting.

Geschikt voor:

- Voor zelfmontage op de meeste metaalbewerkingsmachines.
- Max. hoogte 2,5 meter en toevoer van 8 liter/min.

Bestaande uit:

- 1 koelpomp gemonteerd op het reservoir 11 l
- 1 flexibele kunststof koelmiddelslang
- 1 magneetvoetbevestiging voor de slang
- een aanzuigslang
- Geleverd met een IP-conforme schakelaar.

Tip: kijk naar de spanning van uw machine en maak dan pas uw keuze.

Order nr.	713352002	713352001
Orig. nr.	KME 230V	KME 400V
Spanning	V 230	3x400
Prijs	€ 207,00	213,00

metallsoft



Standaard vernevelapparaat / microdosering

Troeven:

- Universeel inzetbaar voor minimale smering
- Afzonderlijke lucht- en sproeimiddelgeleiding, waardoor het niet druipt.
- Met extra grote smeermiddelreservoir, frequentieregelde pomp en sproeikop.
- Voltage 230V
- Montage niet inbegrepen.

Extra bij MD12:

- Filter drukregelaar met water afscheider
- Robuuste plaatstalen behuizing
- Coaxiale slang met een gevlochten stalen bescherming

Tip: Vergeet uw vernevelolie niet bij te bestellen, 790030015

Order nr.	713608011	713608012
Orig. nr.	MD11	MD12
Spanning	V 230	230
Prijs	€ 496,00	799,00

Cilindrische boren

MACHINES



Rolgewalste borenset.

Troeven:

- Rolgewalst
- DIN338-R type N
- Kwaliteitstaal HSS
- Zwarte uitvoering
- 118°, met een kruisaanslijping vanaf 2 mm.
- Keuze uit 19dlg van 1 tot 10 mm opgaande per 0.5 mm of 25dlg van 1 tot 13 mm opgaand per 0.5 mm.
- Verpakt in een hoogwaardige kunststof doos.

Order nr.	742120019 ^M	742120025 ^M
Orig. nr.	DRMS19	DRMS25
Aantal stuks	19	25
Opgaand	mm per 0,5	per 0,5
Maten	mm 1-10	1-13
Prijs	€ 14,90	29,50



Geslepen borenset

Troeven:

- Volledig geslepen
- DIN338-G type N
- Kwaliteitstaal HSS
- blanke uitvoering
- 118°
- Met een kruisaanslijping vanaf 2 mm
- Keuze uit 19dlg van 1 tot 10 mm opgaande per 0.5 mm of 25dlg van 1 tot 13 mm opgaand per 0.5 mm.
- Verpakt in een hoogwaardige kunststof doos.

Order nr.	742161900 ^M	742162500 ^M
Orig. nr.	DRGS19	DRGS25
Aantal stuks	19	25
Opgaand	mm per 0,5	per 0,5
Maten	mm 1-10	1-13
Prijs	€ 23,50	39,00



Metaalborenset geslepen 28 dlg.

Troeven:

- Diameter 1,0-10mm.
- Snijhoek 118°.
- Split punt voor betere positionele nauwkeurigheid.
- HSS.
- Standaard boren voor gebruik in staal en gietijzer.
- DIN 338.
- Inhoud : 1,0 (4st) - 1,5 (3st) - 2,0 (2st) - 2,5 - 3,0 - 3,5 - 4,0 - 4,5 - 5,0 - 5,5 - 6,0 - 6,5 - 7,0 - 7,5 - 8,0 - 8,5 - 9,0 - 9,5 - 10,0 - 3,3 - 4,2 - 6,8 mm.

Order nr.	151620101 [⊗]
Orig. nr.	DB028
Aantal stuks	28
Prijs	€ 27,90

Hoe kies je de juiste boor?

In ons assortiment hebben we drie soort boren: metaalboren (waaronder cilindrische boren, conische boren, trapboren en verzinkboren), houtboren (waaronder speedboren) en steenboren. Verder kiest u een boor op basis van het materiaal dat u wil boren, de gewenste diameter van de boor en de snijlengte. Om harde metalen te boren, worden boren voorzien van een speciale coating (vb. TIN). De boorsnelheid is afhankelijk van het materiaal dat u boort. Bij boorsnelheid gelden deze regels: Hoe dunner de boor, hoe hoger de draaisnelheid mag zijn. Hoe harder het materiaal, hoe lager de snelheid moet zijn. Boor je met een goeie snelheid, dan krijg je een mooie lange boorkrul of spaan. Met een centerboor maak je eerst een klein puntje om het boren gemakkelijk te starten. Als je een groot gat moet boren, ga je best voorboren.

TIP: gebruik koelolie

Voorkom oververhitte boren en gebruik koelolie of snijolie. Koelolie bevordert de snijcapaciteit van de boor en vergroot zijn levensduur.

Het gebruik van koelolie of snijvloeistof is onmisbaar, want met kernboren bijvoorbeeld wordt aan een veel hogere voeding gedaan. De kernboor beschikt namelijk over meer tanden en met het gebruik van smering zullen deze veel minder vlug slijtage vertonen.

Wat zijn de voordelen van kruisaanslijping?

Boren met kruisaanslijping hebben volgende voordelen:

- Voorboren is niet noodzakelijk.
- Betere centrering en hogere precisie.
- Kleinere verspaningskrachten.
- Betere spananafvoer door spanendeling.



Geslepen borensset



Troeven:

- Volledig geslepen
- DIN338-G type N
- Kwaliteitsstaal HSS, blanke uitvoering
- 118°
- met een kruisaanslijping vanaf 2 mm
- 170 dlg van 1 tot 10 mm opgaande per 0.5 mm per 10 stuks.
- Verpakt in een hoogwaardige metalen koffer met overzichtelijke inleg met maataanduiding.

Order nr.	742161700 
Orig. nr.	DRGS170
Aantal stuks	170
Prijs	€ 99,00



MACHINES

Cutting voordeel pack Metalworks 4 in 1:

1. DRGS25, 742162500, 25-dlg set geslepen boren 1-13 mm
2. MTMS15, 713051015, 15-dlg set tappen M3-M12 + bijhorende boren
3. MTMS6, 713051026, 6-dlg set verzinkboren 6,3 tem 20.5 mm
4. MTMS3, 713051063, 3-dlg set trapboren TiN 4-12, 4-20, 6-30

Bespaar op uw afzonderlijke sets!

Order nr.	713051004 
Orig. nr.	MTM4
Prijs	€ 172,00



HSS metaalboor DIN338-R rolgewalste uitvoering.

Troeven:

- DIN338-R
- Zwart genitreerd.
- Snijhoek 118°
- Cilindrische schacht

Geschikt voor staal tot R kleiner dan 650 N/mm2:

- Ideaal voor het boren in gietijzer, staal, gelegeerd en onlegeerd to.

Smering:

- Voldoende smering gebruiken

Verpakt per 5 of 10 stuks naargelang de maat. VE = verpakkingseenheid.

Order nr.	Orig. nr.	Maat mm	Snijlengte mm	VE	Prijs/VE €
742121005	DRM0050	0,5	6	10	4,00
742121010	DRM0100	1	12	10	2,80
742121011	DRM0110	1,1	12	10	2,40
742123125	DRM0125	1,25	12	10	2,80
742121012	DRM0120	1,2	12	10	2,40
742121013	DRM0130	1,3	12	10	2,40
742121014	DRM0140	1,4	12	10	2,40
742121015	DRM0150	1,5	18	10	2,40
742121016	DRM0160	1,6	18	10	2,40
742121017	DRM0170	1,7	18	10	2,40
742121175	DRM0175	1,75	18	10	2,80
742121018	DRM0180	1,8	18	10	2,40
742121019	DRM0190	1,9	18	10	2,40
742121020	DRM0200	2	24	10	2,40
742121021	DRM0210	2,1	24	10	2,60
742121022	DRM0220	2,2	24	10	2,60
742121225	DRM0225	2,25	30	10	3,40
742121023	DRM0230	2,3	24	10	2,60
742121024	DRM0240	2,4	24	10	2,60
742121025	DRM0250	2,5	30	10	2,60
742121026	DRM0260	2,6	30	10	2,60
742121027	DRM0270	2,7	30	10	2,60
742121275	DRM0275	2,75	30	10	3,40
742121028	DRM0280	2,8	30	10	2,60
742121029	DRM0290	2,9	30	10	2,60
742121030	DRM0300	3	33	10	2,60
742121031	DRM0310	3,1	33	10	3,10
742121032	DRM0320	3,2	33	10	3,10
742121325	DRM0325	3,25	33	10	3,80
742121033	DRM0330	3,3	33	10	3,10
742121034	DRM0340	3,4	33	10	3,10
742121035	DRM0350	3,5	39	10	3,10
742121036	DRM0360	3,6	39	10	3,10
742121375	DRM0375	3,75	39	10	3,80
742121038	DRM0380	3,8	39	10	3,10
742121039	DRM0390	3,9	39	10	3,10
742121040	DRM0400	4	43	10	3,10
742121041	DRM0410	4,1	43	10	4,30
742121042	DRM0420	4,2	43	10	4,30
742121425	DRM0425	4,25	43	10	5,20
742121043	DRM0430	4,3	43	10	4,30
742121044	DRM0440	4,4	43	10	4,30
742121045	DRM0450	4,5	47	10	4,30
742121046	DRM0460	4,6	47	10	4,30
742121047	DRM0470	4,7	47	10	4,30
742121475	DRM0475	4,75	47	10	5,20
742121048	DRM0480	4,8	47	10	4,30
742121049	DRM0490	4,9	47	10	4,30
742121050	DRM0500	5	55	10	4,30

Order nr.	Orig. nr.	Maat mm	Snijlengte mm	VE	Prijs/VE €
742121051	DRM0510	5,1	52	10	5,70
742121052	DRM0520	5,2	52	10	5,70
742121525	DRM0525	5,25	52	10	7,00
742121053	DRM0530	5,3	52	10	5,70
742121054	DRM0540	5,4	52	10	5,70
742121055	DRM0550	5,5	57	10	5,70
742121056	DRM0560	5,6	57	10	5,70
742121057	DRM0570	5,7	57	10	5,70
742121575	DRM0575	5,75	57	10	7,00
742121058	DRM0580	5,8	57	10	5,70
742121059	DRM0590	5,9	57	10	5,70
742121060	DRM0600	6	57	10	5,70
742121061	DRM0610	6,1	57	10	7,40
742121062	DRM0620	6,2	57	10	7,40
742121625	DRM0625	6,25	57	10	8,70
742121065	DRM0650	6,5	63	10	7,40
742121067	DRM0670	6,7	63	10	8,90
742121700	DRM0675	6,75	63	10	10,90
742121068	DRM0680	6,8	63	10	8,90
742121069	DRM0690	6,9	63	10	8,90
742121070	DRM0700	7	69	10	8,90
742121071	DRM0710	7,1	69	5	4,90
742121072	DRM0720	7,2	69	5	4,90
742121725	DRM0725	7,25	69	5	6,10
742121073	DRM0730	7,3	69	5	4,90
742121074	DRM0740	7,4	69	5	4,90
742121075	DRM0750	7,5	69	5	4,90
742121076	DRM0760	7,6	69	5	5,20
742121077	DRM0770	7,7	69	5	5,20
742121775	DRM0775	7,75	69	5	6,40
742121079	DRM0790	7,9	69	5	5,20
742121080	DRM0800	8	75	5	5,20
742121081	DRM0810	8,1	75	5	6,40
742121082	DRM0820	8,2	75	5	6,40
742121825	DRM0825	8,25	75	5	7,60
742121084	DRM0840	8,4	75	5	6,40
742121085	DRM0850	8,5	75	5	6,40
742121086	DRM0860	8,6	75	5	7,00
742121087	DRM0870	8,7	75	5	7,00
742121875	DRM0875	8,75	75	5	8,30
742121088	DRM0880	8,8	75	5	7,00
742121089	DRM0890	8,9	75	5	7,00
742121090	DRM0900	9	81	5	7,00
742121091	DRM0910	8,1	81	5	8,10
742121092	DRM0920	9,2	81	5	8,10
742121925	DRM0925	9,25	81	5	9,60
742121093	DRM0930	9,3	81	5	8,10
742121094	DRM0940	9,4	81	5	8,10
742121095	DRM0950	9,5	81	5	8,10
742121096	DRM0960	9,6	81	5	8,10
742121097	DRM0970	9,7	81	5	8,10
742121975	DRM0975	9,75	81	5	9,60
742121098	DRM0980	9,8	81	5	8,10
742121099	DRM0990	9,9	81	5	8,10
742121100	DRM1000	10	87	5	8,10
742122025	DRM1025	10,25	87	5	12,50
742121105	DRM1050	10,5	87	5	10,50
742122075	DRM1075	10,75	87	5	13,90
742121110	DRM1100	11	94	5	11,90
742122125	DRM1125	11,25	94	5	13,90
742121115	DRM1150	11,5	94	5	11,90
742122175	DRM1175	11,75	94	5	14,90
742121120	DRM1200	12	101	5	12,90
742122225	DRM1225	12,25	101	5	16,90
742121125	DRM1250	12,5	101	5	14,90
742122275	DRM1275	12,75	101	5	18,50
742121130	DRM1300	13	101	5	15,90
742121135	DRM1350	13,5	108	5	19,80
742121140	DRM1400	14	108	5	21,80
742121145	DRM1450	14,5	114	3	14,70
742121150	DRM1500	15	114	3	20,30
742121155	DRM1550	15,5	120	5	36,00
742121160	DRM1600	16	120	3	25,50

MACHINES

MACH

HSS
G

130°

DIN1897



HSS-G extra korte metaalboor DIN1897 volledig geslepen uitvoering.

Troeven:

- DIN1897 - extra korte uitvoering
- Split point, kruisaanslijping
- Zwart genitreed.
- Snijhoek 130°
- Cilindrische schacht
- Kwalitatief hoogstaande boor

Geschikt voor staal tot R entl; 800 N/mm²:

- Ideaal voor het boren in gietijzer, staal, gelegeerd en ongelegeerd.
- Om te gebruiken bij magneetboormachines en hun geringe boordiepte, handboormachines

Smring:

- Voldoende smring gebruiken

Verpakt per 5 of 10 stuks naargelang de maat. VE = verpakkingseenheid.

Order nr.	Orig. nr.	Maat mm	Snijlengte mm	VE	Prijs/VE €
742170200	DRK0200	2	12	10	6,10
742170250	DRK0250	2,5	14	10	9,50
742170300	DRK0300	3	16	10	11,90
742170325	DRK0325	3,25	18	10	12,90
742170350	DRK0350	3,5	20	10	12,90
742170375	DRK0375	3,75	20	10	14,90
742170400	DRK0400	4	22	10	14,90
742170425	DRK0425	4,25	22	10	18,50
742170450	DRK0450	4,5	24	10	16,50
742170475	DRK0475	4,75	24	10	18,50
742170500	DRK0500	5	26	10	16,90
742170525	DRK0525	5,25	26	10	24,50
742170550	DRK0550	5,5	28	10	22,90
742170575	DRK0575	5,75	28	10	26,90
742170600	DRK0600	6	28	10	25,90
742170650	DRK0650	6,5	31	10	30,50
742170700	DRK0700	7	34	10	35,90
742170750	DRK0750	7,5	34	5	19,50
742170800	DRK0800	8	37	5	22,90
742170850	DRK0850	8	37	5	30,50
742170900	DRK0900	9	40	5	34,90
742171000	DRK1000	10	43	5	45,50

MACH

HSS
G

130°

DIN338



HSS-G metaalboor DIN338 volledig geslepen uitvoering.

Troeven:

- DIN338 - standaard lengte
- Split point, kruisaanslijping vanaf \varnothing 3 mm
- Blanke uitvoering
- Snijhoek 130°
- Cilindrische schacht
- Kwalitatief hoogstaande boor

Geschikt voor staal tot R kleiner dan 800 N/mm²:

- Ideaal voor het boren in gelegeerd staal.

Smring:

- Voldoende smring gebruiken

Verpakt per 5 of 10 stuks naargelang de maat. VE = verpakkingseenheid.

Order nr.	Orig. nr.	Maat mm	Snijlengte mm	VE	Prijs/VE €
742101005	DRG0050	0,5	6	10	21,50
742101010	DRG0100	1	12	10	12,50
742101015	DRG0150	1,5	18	10	11,90
742101020	DRG0200	2	24	10	9,20
742101025	DRG0250	2,5	30	10	10,50
742101026	DRG0260	2,6	30	10	11,90
742101030	DRG0300	3	33	10	10,90
742101033	DRG0330	3,3	36	10	13,90
742101035	DRG0350	3,5	39	10	12,90
742101040	DRG0400	4	43	10	13,90
742101041	DRG0410	4,1	43	10	17,50
742101042	DRG0420	4,2	43	10	17,50
742101045	DRG0450	4,5	47	10	15,90
742101050	DRG0500	5	52	10	17,50
742101055	DRG0550	5,5	57	10	26,90
742101060	DRG0600	6	57	10	23,90
742101065	DRG0650	6,5	63	10	30,50
742101068	DRG0680	6,8	69	10	38,90
742101070	DRG0700	7	69	10	35,90
742101075	DRG0750	7,5	69	5	19,50
742101080	DRG0800	8	75	5	22,90
742101085	DRG0850	8,5	75	5	27,90
742101090	DRG0900	9	81	5	28,90
742101095	DRG0950	9,5	81	5	30,50
742101100	DRG1000	10	87	5	32,50
742101102	DRG1025	10,25	87	5	46,50
742101105	DRG1050	10,5	87	5	40,90
742101110	DRG1100	11	94	5	48,50
742101150	DRG1150	11,5	94	5	51,50
742101120	DRG1200	12	101	5	56,50
742101125	DRG1250	12,5	101	5	60,90
742101130	DRG1300	13	101	5	64,90



HSS-G metaalboor DIN340 lange uitvoering.

Troeven:

- DIN340 - lange uitvoering
- Split point, kruisaanslijping vanaf ø 3 mm
- Zwarte genitreeerde uitvoering
- Snijhoek 130°
- Cilindrische schacht
- Kwalitatief hoogstaande boor

Geslacht voor staal tot R kleiner dan 800 N/mm2:

- Ideaal voor het boren in gelegeerd staal.

Smering:

- Voldoende smering gebruiken

Verpakt per 5 of 10 stuks naargelang de maat. VE = verpakkingseenheid.

Order nr.	Orig. nr.	Maat mm	VE	Prijs/VE €
742180200	DRLO200	2	10	21,90
742180250	DRLO250	2,5	10	22,90
742180300	DRLO300	3	10	26,90
742180325	DRLO325	3,25	10	28,90
742180350	DRLO350	3,5	10	27,90
742180375	DRLO375	3,75	10	29,90
742180400	DRLO400	4	10	28,90
742180425	DRLO425	4,25	10	36,90
742180450	DRLO450	4,5	10	36,90
742180475	DRLO475	4,75	10	37,90
742180500	DRLO500	5	10	35,90
742180525	DRLO525	5,25	10	49,50
742180550	DRLO550	5,5	10	49,50
742180575	DRLO575	5,75	10	53,50
742180600	DRLO600	6	10	53,50
742180650	DRLO650	6,5	5	28,90
742180700	DRLO700	7	5	32,50
742180750	DRLO750	7,5	5	38,50
742180800	DRLO800	8	5	43,50
742180850	DRLO850	8,5	5	59,50
742180900	DRLO900	9	5	62,50
742180950	DRLO950	9,5	5	66,90
742181000	DRL1000	10	5	65,90
742181050	DRL1050	10,5	5	79,90
742181100	DRL1100	11	5	80,90
742181150	DRL1150	11,5	5	89,90
742181200	DRL1200	12	5	96,90
742181250	DRL1250	12,5	5	100,00
742181300	DRL1300	13	5	117,00



HSS-Co5% metaalboor DIN338 volledig geslepen uitvoering.

Troeven:

- HSS kobalt 5% (Per stuk cobalt 8% op bestelling leverbaar)
- DIN338 - standaard lengte
- Split point, kruisaanslijping vanaf ø 3 mm
- Bronskleurige uitvoering
- Snijhoek 130°
- Cilindrische schacht
- Kwalitatief hoogstaande boor

Geslacht voor staal tot R kleiner dan 1200 N/mm2:

- Ideaal voor het boren in gelegeerd staal, roestvrij staal.

Smering:

- Voldoende smering gebruiken

VE = verpakkingseenheid.

Order nr.	Orig. nr.	Maat mm	Snijlengte mm	Totale lengte mm	Prijs €
742090100	DRCO100C	1	12	34	2,00
742090150	DRCO150C	1,5	18	40	2,20
742090200	DRCO200C	2	24	49	2,10
742090250	DRCO250C	2,5	30	57	2,20
742090300	DRCO300C	3	33	61	2,20
742090350	DRCO350C	3,5	39	70	2,50
742090400	DRCO400C	4	43	75	3,30
742090450	DRCO450C	4,5	47	80	3,30
742090500	DRCO500C	5	52	86	3,10
742090550	DRCO550C	5,5	57	93	4,00
742090600	DRCO600C	6	57	93	4,00
742090650	DRCO650C	6,5	63	101	5,20
742090700	DRCO700C	7	69	109	6,10
742090750	DRCO750C	7,5	69	109	6,10
742090800	DRCO800C	8	75	117	7,20
742090850	DRCO850C	8,5	75	117	7,60
742090900	DRCO900C	9	81	125	9,20
742090950	DRCO950C	9,5	81	125	9,80
742091000	DRCO1000C	10	87	133	10,90
742091100	DRCO1100C	11	94	142	15,90
742091200	DRCO1200C	12	101	151	18,50
742091300	DRCO1300C	13	101	151	20,50

MACH

HSS-CO
G 130°
DIN338

HSS-Co5% metaalboor DIN338 volledig geslepen uitvoering.

Troeven:

- HSS kobalt 5% (Per stuk cobalt 8% op bestelling leverbaar)
- DIN338 - standaard lengte
- Split point, kruisaanslijping vanaf \varnothing 3 mm
- Bronskleurige uitvoering
- Snijhoek 130°
- Cilindrische schacht
- Kwalitatief hoogstaande boor

Geschikt voor staal tot R kleiner dan 1200 N/mm²:

- Ideaal voor het boren in gelegeerd staal, roestvrij staal.

Smearing:

- Voldoende smearing gebruiken
- Verpakt per 5 of 10 stuks naargelang de maat.
VE = verpakkingseenheid.

Order nr.	Orig. nr.	Maat	Snij- lengte	Totale lengte	VE	Prijs/VE
		mm	mm	mm		€
742080100	DRCO100	1	12	10	10	11,90
742080125	DRCO125	1,25	16	10	10	14,90
742080150	DRCO150	1,5	18	10	10	13,90
742080175	DRCO175	1,75	22	10	10	13,90
742080200	DRCO200	2	24	10	10	12,50
742080225	DRCO225	2,25	27	10	10	14,90
742080250	DRCO250	2,5	30	10	10	13,90
742080275	DRCO275	2,75	33	10	10	14,90
742080300	DRCO300	3	33	10	10	13,90
742080325	DRCO325	3,25	36	10	10	18,50
742080350	DRCO350	3,5	39	10	10	16,50
742080375	DRCO375	3,75	39	10	10	20,50
742080400	DRCO400	4	43	10	10	18,50
742080425	DRCO425	4,25	43	10	10	22,90
742080450	DRCO450	4,5	47	10	10	20,50
742080475	DRCO475	4,75	47	10	10	24,90
742080500	DRCO500	5	52	10	10	22,90
742080525	DRCO525	5,25	52	10	10	33,50
742080550	DRCO550	5,5	57	10	10	29,90
742080575	DRCO575	5,75	57	10	10	33,50
742080600	DRCO600	6	57	10	10	29,90
742080650	DRCO650	6,5	63	10	10	40,90
742080700	DRCO700	7	69	10	10	49,50
742080750	DRCO750	7,5	69	5	5	24,90
742080800	DRCO800	8	75	5	5	29,90
742080850	DRCO850	8,5	75	5	5	31,50
742080900	DRCO900	9	81	5	5	38,90
742080950	DRCO950	9,5	81	5	5	41,90
742081000	DRCO1000	10	87	5	5	45,90
742081050	DRCO1050	10,5	87	5	5	57,90
742081100	DRCO1100	11	94	5	5	66,90
742081150	DRCO1150	11,5	94	5	5	69,90
742081200	DRCO1200	12	101	5	5	77,90
742081250	DRCO1250	12,5	101	5	5	84,90
742081300	DRCO1300	13	101	5	5	86,50

MACH

Speedmaster speciaal geslepen metaalboor DIN338.

Troeven:

- Volledig geslepen boor uit zijn totaliteit
- **Dubbele chip breaker:** speciale slijpmethode waardoor een hogere snijkwaliteit wordt bereikt dan de klassieke geslepen uitvoering.
- De snijtop is voorzien van 3 platte hoeken (vanaf \varnothing 5 mm) voor een volledige krachtoverbrenging.
- Micro zelfcenterende punt
- Kruisaanslijping "Split point" vanaf \varnothing 2,5 mm
- Dubbele snijhoeken met speciaal relief, maximum snijcapaciteit met hoge weerstand op de snijhoeken.

Materialen tot R kleiner dan 900N/mm²

- Gelegeerd staal, hoog gelegeerd staal, roestvrij staal, ijzer, aluminium

Geschikt voor:

- Hand- en stationaire boormachines
- Industrieel toepassingsveld.

Verpakt per 5 of 10 naargelang de maat.
VE = verpakkingseenheid.

Order nr.	Orig. nr.	Maat	Snij- lengte	Totale lengte	VE	Prijs/VE
		mm	mm	mm		€
742070100	DRSM0100	1	12	34	10	14,90
742070150	DRSM0150	1,5	18	40	10	14,90
742070200	DRSM0200	2	24	49	10	14,90
742070250	DRSM0250	2,5	30	57	10	14,90
742070300	DRSM0300	3	33	61	10	15,90
742070350	DRSM0350	3,5	39	70	10	18,50
742070400	DRSM0400	4	43	75	10	20,50
742070450	DRSM0450	4,5	47	80	10	22,90
742070500	DRSM0500	5	52	86	10	26,50
742070550	DRSM0550	5,5	57	93	10	33,50
742070600	DRSM0600	6	57	93	10	35,90
742070650	DRSM0650	6,5	63	101	10	41,50
742070700	DRSM0700	7	69	109	10	48,50
742070750	DRSM0750	7,5	69	109	5	26,50
742070800	DRSM0800	8	75	117	5	31,90
742070850	DRSM0850	8,5	75	117	5	34,90
742070900	DRSM0900	9	81	125	5	39,90
742070950	DRSM0950	9,5	81	125	5	42,90
742071000	DRSM1000	10	87	133	5	49,50
742071050	DRSM1050	10,5	87	133	5	53,50
742071100	DRSM1100	11	94	143	5	60,50
742071150	DRSM1150	11,5	94	142	5	65,90
742071200	DRSM1200	12	101	151	5	75,50
742071250	DRSM1250	12,5	101	151	5	80,90
742071300	DRSM1300	13	101	151	5	86,50



HSS metaalboor met afgedraaide schacht 10 of 13 mm

Troeven:

- HSS rolgewalste uitvoering
- Verminderde / afgedraaide schacht van 10 of 13 mm
- Genitreerde uitvoering
- Snijhoek 130°
- Cilindrische schacht

Geschikt voor:

- Ideaal voor het boren met handboormachines of het plaatsen van grotere diameters van boren in een beperkte boorhouder tot 10 / 13 mm.

Smering:

- Voldoende smering gebruiken

Verpakt per 3 of 5 naargelang de maat. VE = verpakkingseenheid.

Order nr.	Orig. nr.	Maat	Snijlengte	Schacht	VE	Prijs/VE
		mm	mm	mm		€
742131105	DRMS1050	10,5	87	10	5	13,90
742131100	DRMS1100	11	94	10	5	14,90
742131150	DRMS1150	11,5	94	10	5	12,90
742131200	DRMS1200	12	101	10	5	16,50
742131250	DRMS1250	12,5	101	10	5	2,95
742131300	DRMS1300	13	101	10	5	20,50
742131350	DRMS1350	13,5	108	13	3	16,50
742131400	DRMS1400	14	108	13	3	18,50
742131450	DRMS1450	14,5	114	13	3	19,50
742131500	DRMS1500	15	114	13	3	26,90
742131550	DRMS1550	15,5	120	13	3	29,50
742131600	DRMS1600	16	120	13	3	31,90
742131650	DRMS1650	16,5	125	13	1	11,90
742131700	DRMS1700	17	125	13	1	12,50
742131750	DRMS1750	17,5	130	13	1	12,90
742131800	DRMS1800	18	130	13	1	13,90
742131850	DRMS1850	18,5	135	13	1	14,50
742131900	DRMS1900	19	135	13	1	14,90
742131950	DRMS1950	19,5	140	13	1	15,50
742132000	DRMS2000	20	140	13	1	15,90

Conische boren



9-delige set gewalste boren met conische schacht.

Troeven:

- Set MK2 tot en met 22 gewone schacht, 24 en groter met verdunde schacht.
- MK3 gewone schacht.
- In alu opbergkoffer met overzichtelijke inleg en maataanduiding.

Order nr.	713051002	713051003
Diameter	mm 14,5-16-18-20-22-24-26-28-30	14,5-16-18-20-22-24-26-28-30
Aansluiting	MK 2	3
Prijs	€ 161,00	169,00



Rolgewalste conische metaalboor HSS DIN345.

Troeven:

- DIN345
- Zwart genitreerd.
- Snijhoek 118°
- Conische schacht

Geschikt voor staal tot R kleiner dan 650 N/mm2:

- Ideaal voor het boren in gietijzer, staal, gelegeerd en ongelegeerd.
- Magneetboormachines met conische opname
- Tafel- en kolomboormachines met conische opname
- Boorfreesmachines met conische opname

Smering:

- Voldoende smering gebruiken

VE = verpakkingseenheid.

Tip: Grotere maten tot 100 mm op aanvraag leverbaar.

Centreerboren

MACH



HSS
G
60°
DIN333A

Industriële centerborensset

Troeven:

- HSS
- DIN333 vorm A
- 60°
- Metrisch
- Volledig geslepen
- Rechts
- 7 delig in een hoogwaardige kunststofdoos met inleg.

Bij het boren van gaten op een metalen oppervlak zoekt de boor telkens naar een uitweg, dus maakt men best eerst een gatje, dit gebeurt met een centerboor, zo zoekt de boor het center van het gat, voorkomt men dat de boor wegloopt en bekomt men een preciezer geleiding van de boor. Kan gebruikt worden op allerlei toestellen, maar meestal op draaibanken.

Diameters: 1.0 x 3.15 - 1.6 x 4.0 - 2.0 x 5.0 - 2.5 x 6.3 - 3.15 x 8.0 - 4.0 x 10.0 - 5.0 x 12.5 mm

Order nr.	748240000 M	
Orig. nr.	DRCD51	
Aantal stuks	7	
Diameter	mm	1x3,15 - 1,6x4,0 - 2x5,0 - 2,5x6,3 - 3,5x8,0 - 4x10,0 - 5x12,5
Prijs	€	15,90

MACH



HSS
G
60°
DIN333A

Geslepen centreerboor HSS

Troeven:

- DIN333A
- HSS
- Geslepen
- Snijhoek 60°

Verpakt per stuk.

Order nr.	Orig. nr.	Diameter mm	D mm	Lengte mm	Prijs €
748240100 M	DRCD0100	1	3,15	31,5	6,70
748240160 M	DRCD0160	1,6	4	35,5	6,60
748240200 M	DRCD0200	2	5	40	7,00
748240250 M	DRCD0250	2,5	6	45	7,40
748240315 M	DRCD0315	3,15	6,3	50	8,70
748240400 M	DRCD0400	4	8	56	16,90
748240500 M	DRCD0500	5	10	63	23,50
748240630 M	DRCD0630	6,3	16	71	35,90

Order nr.	Diameter mm	Snijlengte mm	Aansluiting MK	Prijs €
748231001 M	11	94	1	7,70
748231102 M	11,5	94	1	8,10
748231203 M	12	101	1	8,10
748231304 M	12,5	101	1	8,50
748231405 M	13	101	1	8,50
748231506 M	13,5	101	1	10,90
748231607 M	14	108	1	10,90
748231708 M	14,5	108	2	12,90
748231809 M	15	114	2	12,90
748231910 M	15,5	114	2	12,90
748232011 M	16	120	2	12,90
748232112 M	16,5	120	2	14,90
748232213 M	17	125	2	14,90
748232314 M	17,5	125	2	15,90
748232415 M	18	130	2	15,90
748232516 M	18,5	130	2	16,50
748232617 M	19	135	2	16,50
748232718 M	19,5	135	2	16,90
748232819 M	20	140	2	16,90
748232920 M	20,5	140	2	21,50
748233021 M	21	145	2	21,50
748233122 M	21,5	145	2	22,90
748233223 M	22	150	2	22,90
748233324 M	22,5	150	2	25,50
748233425 M	23	155	2	25,50
748233526 M	23,5	155	3	28,50
748233627 M	24	160	3	28,50
748233728 M	24,5	160	3	29,90
748233829 M	25	160	3	29,90
748233930 M	25,5	160	3	34,90
748234031 M	26	165	3	34,90
748234132 M	26,5	165	3	35,90
748234233 M	27	170	3	35,90
748234334 M	27,5	170	3	37,90
748234435 M	28	170	3	37,90
748234536 M	28,5	170	3	40,90
748234637 M	29	175	3	40,90
748234738 M	29,5	175	3	44,50
748234839 M	30	175	3	44,50
748234940 M	30,5	175	3	49,50
748235041 M	31	180	3	45,50
748235142 M	31,5	180	3	58,50
748235243 M	32	185	4	75,50
748235344 M	32,5	185	4	75,50
748235445 M	33	185	4	83,50
748235546 M	33,5	185	4	83,50
748235647 M	34	190	4	88,50
748235748 M	34,5	190	4	88,50
748235849 M	35	190	4	97,50
748235950 M	35,5	190	4	96,50
748236051 M	36	195	4	125,00
748236152 M	36,5	195	4	111,00
748236253 M	37	195	4	111,00
748236455 M	38	200	4	130,00
748236657 M	39	200	4	130,00
748236859 M	40	200	4	130,00

Verzinkboren



6-delige set HSS M2 verzinkboren TiN gecoat

Troeven:

- TiN = Titanium Nitride. Dit is een bescherm laag, die de warmteontwikkeling beperkt en de levensduur van de snijplaat aanzienlijk verlengt
- HSS M2 kwalitatieve HSS soort
- Geslepen snijvlakken
- Maten gelaserd op de schacht om snel en correct te werken.
- Verpakt in een hoogwaardige kunststof doos

Kenmerken:

- DIN335C
- Hoek 90°
- Met cilindrische schacht.

Order nr.	713051026 M						
Orig. nr.	MTMS6						
Aantal stuks	6						
Diameter	mm	6,3	8,3	10,4	12,4	16,5	20,5
Gewicht	kg	1,00					
Afmetingen (l x b x h)	mm	180 x 130 x 50					
Prijs	€	39,90					



HSS verzinkboren 3 tanden op 90°



Troeven:

- Volgens DIN 335-C.
- Hoek van 90°
- Geslepen uitvoering
- Europese kwaliteit HSS
- Met cilindrische schacht.



Verpakt per stuk.

Order nr.	Orig. nr.	Diameter	Lengte	D	Voor vijzen	Gewicht	Prijs
		mm	mm	mm	DIN748F	kg	€
748279063 M	DVZ63	6,3	45	5	M3	0,02	15,90
748279073 M	DVZ73	7,3	50	6		0,02	18,50
748279083 M	DVZ83	8,3	50	6	M4	0,02	18,50
748279094 M	DVZ94	9,4	50	6		0,02	20,50
748279104 M	DVZ104	10,4	50	6	M5	0,02	22,50
748279124 M	DVZ124	12,4	56	8	M6	0,03	23,90
748279015 M	DVZ15	15	60	10		0,05	27,90
748279165 M	DVZ165	16,5	60	10	M8	0,05	28,90
748279205 M	DVZ205	20,5	63	10	M10	0,06	39,90



HSS-XE verzinkboor 3 lippen.

Troeven:

- Met universele Weldon schacht 19mm 3/4"
- Hoek 90°.
- Europese kwaliteit HSS-XE

Geschikt voor:

- kernboormachines of op machines met Weldon-opname.

Order nr.	Orig. nr.	Diameter	Lengte	Gewicht	Prijs
		mm	mm	kg	€
748255080 M	38720.129525	25	43	0,10	27,50
748255081 M	38720.129530	30	47	70,00	34,90
748255082 M	38720.129540	40	52	70,00	46,90
748255083 M	38720.129550	55	63	70,00	86,50

Trapboren



Maten	4-12	4-20
Aantal stappen	10	10
Stappen	mm 4-5-6-7-8-9-10-11-12	4-6-8-10-12-14-16-18-20
Max. materiaaldikte	mm 3	4
Schacht	mm 6	8

3-delige set trapboor HSS met TiN coating

Troeven:

- Kwaliteitstaal HSS
- Titanium gecoat, rechte uitvoering en cilindrische schacht.
- Van 4-12, 4-20 en 6-30 mm.
- Verpakt in een hoogwaardige kunststof doos.

Geschikt voor:

- het boren van buizen, platen en dunne materialen zoals staal.

Tip: De TiN coating zorgt ervoor dat het snij oppervlak van de trapboor een hogere graad van hardheid krijgt en hogere stabiliteit van temperatuur aan kan met een lagere wrijvingscoëfficiënt.

Order nr.	713051063 M						
Orig. nr.	MTMS3						
Aantal stuks	3						
Diameter min.-max.	mm	4-12 · 4-20 · 6-30					
Prijs	€	54,90					



Materiaal	4-12	4-20	6-30
Aantal stuks	3	3	3
Diameter	4-12, 4-20, 6-30	4-12, 4-20, 6-30	4-12, 4-20, 6-30
Werkzaamheidsdiepte	12, 20, 30	12, 20, 30	12, 20, 30
Werkzaamheidsdiepte	12, 20, 30	12, 20, 30	12, 20, 30
Werkzaamheidsdiepte	12, 20, 30	12, 20, 30	12, 20, 30
Werkzaamheidsdiepte	12, 20, 30	12, 20, 30	12, 20, 30

3-delige set industriële spiraal trapboren met TiAlN coating.

Troeven:

- Kwaliteitsstaal HSS
- TiAlN gecoat
- Spiraal trapboren hebben een veel betere spanenevacuatie dan de gewone rechtlijnige trapboren.
- Uitvoering: met 2 snijkanten, kruis geslepen en met kantenbreker.
- De lippen zijn CBN geslepen uit een vaste geharde vorm. Er worden hierdoor betere en scherpere snijkanten verkregen - zonder bramen.
- De mm maten zijn laser gemarkeerd op de tool zelf.
- Door de speciale schacht wordt het slippen in de boorkop voorkomen
- Van 4-12, 4-20 en 6-30 mm.
- Verpakt in een hoogwaardige kunststof doos.

Geschikt voor:

- De ideale tool voor de plaatbewerking, bruikbaar in de volgende sectoren van de industrie: electrotechniek, sanitaire, verwarmingstechniek, automotive, machinebouw en luchtvaart.
- Deze uiterst harde tool is geschikt voor alle gangbare industriële materialen : non-ferro metaal, speciaal staal, thermoplastische en duroplastische kunststoffen.
- Deze duurzame en veelzijdige tool zal centeren, punten, ruimen en ontbramen - allemaal in een vloeiende werkcyclus.

Tip: Met TiAlN coating. (Algemeen verhogen de meeste coatings de hardheid van de tool en / of de gladheid. Een coating laat toe dat de snijkanten van het gereedschap mooi langsheen het materiaal glijdt, zonder dat er materiaal blijft kleven aan de tool. Coatings helpen ook met het verlagen van de temperatuur geassocieerd met het snijproces en verlengt de levensduur).

Order nr.	790025150		
Orig. nr.	MTMS4		
Aantal stuks	3		
Diameter min.-max.	mm	4-12 · 4-20 · 6-30	
Prijs	€	74,90	



HSS trapboren.



Troeven:

- Met cilindrische schacht
- Metrisch
- CBN geslepen uitvoering
- Europese kwaliteit HSS
- Verpakt per stuk.

Geschikt voor:

- staal tot R_enl; 600 N/mm²
- het boren van platen

Order nr.	Orig. nr.	GR	Diameter min.-max. mm	Stappen mm	Prijs €
748280101	DRSD1	1	4-12	5	28,50
748280102	DRSD2	2	4-12	9	30,90
748280103	DRSD3	3	12-20	9	79,90
748280104	DRSD4	4	4-20	9	41,50
748280105	DRSD5	5	20-30	11	126,00
748280106	DRSD6	6	4-30	13	86,50
748280109	DRSD9	9	6-36	-	186,00
748280124	DRSD24	24	6-38	-	145,00



HSS Conische trapboren.

Troeven:

- Met cilindrische schacht
- Metrisch
- CBN geslepen uitvoering
- Europese kwaliteit HSS
- Verpakt per stuk.

Geschikt voor:

- staal tot R_enl; 600 N/mm²
- het boren van platen en buizen.

Order nr.	Orig. nr.	GR	Diameter min.-max. mm	Prijs €
748320010	DRSDC1	1	3-14	21,50
748320020	DRSDC2	2	6-20	35,90
748320030	DRSDC3	3	16-30,5	64,50
748320040	DRSDC4	4	26-40	139,00
748320070	DRSDC7	7	3-31	100,00

Kernboren



Set kernboren HSS-E 6-dlg + pin.

Troeven:

- Weldon aansluiting 19.05 mm
- Multicut geometrisch geslepen
- Hoog kwaliteitstaal
- Snijdiepte 25mm..

Standaard geleverd met:

- 6 kernboren 12-14-16-18-20-22mm.
- Pilootpun CPK25 - 6,34/5,3x77 mm
- in een hoogwaardige kunststof doos.

Order nr.	790302500	
Orig. nr.	HQS625	
Prijs	€	99,00



13-delige set kernboren met Weldon van 12 tot 20 mm met kernboorhouder, sleutel en 2 pilootpinnen. Snijdiepte 50 mm.

Troeven:

- 3 keer vlugger boren dan met gewone boren
- Voorkom voorboren
- Werken aan hogere snijnsnelheden
- Meerdere afmetingen onmiddellijk bij de hand

Geschikt voor:

- alle magneetboormachines met Morse Konus opname (rekening houdend met diepte)
- tafel en kolomboormachines, boorfreesmachines
- servicewagens, installateur, etc.

Standaard geleverd met:

- in hoogwaardige, stevige kunststoffen koffer met inleg schuimrubber voor bescherming met inleg.
- 9 kernboren
- 2 pilootpinnen
- 1 kernboorhouder met sleutel

Tip:

- Het gebruik van snijvloeistof is onmisbaar, want het werkelijk boren wordt aan een veel hogere voeding gedaan, omdat de kernboor over meer tanden beschikt en zo veel minder slag slijtage vertoont.
- U zoekt gewoonweg de Morse konus opname van uw boormachine op en u kunt deze uitzonderlijke technologie bij u toepassen.

Order nr.	Orig. nr.	Aan-sluiting	Diameter	Snij-diepte	Aantal piloot-pinnen	Type piloot-pin	Prijs
		MK	mm	mm	st		€
790302641	KBS132	2	12-13-14-15-16-17-18-19-20	50	2	CPL50	205,00
790302643	KBS133	3	12-13-14-15-16-17-18-19-20	50	2	CPL50	229,00
790302645	KBS134	4	12-13-14-15-16-17-18-19-20	50	2	CPL50	234,00
790302642	KBS132M	2/M10	12-13-14-15-16-17-18-19-20	50	2	CPL50	205,00
790302644	KBS133M	3/M12	12-13-14-15-16-17-18-19-20	50	2	CPL50	215,00
790302646	KBS134M	4/M16	12-13-14-15-16-17-18-19-20	50	2	CPL50	234,00

MACH



23-delige set kernboren van 12 tot 30 mm en 4 pilotpinnen met snijdieptes 25 of 50mm.

Troeven:

- 3 keer vlugger boren dan met gewone boren
- Voorkom voorboren
- Werken aan hogere snijsnelheden
- Meerdere afmetingen onmiddellijk bij de hand

Geschikt voor:

- alle magneetboormachines met weldon opname (rekening houdend met diepte)
- servicewagens, installateur, etc.

Standaard geleverd met:

- in hoogwaardige, stevige kunststoffen koffer met inleg schuimrubber voor bescherming met inleg.
- 19 kernboren
- 4 pilotpinnen

Tip:

- Het gebruik van snijvloeistof is onmisbaar, want het werkelijk boren wordt aan een veel hogere voeding gedaan, omdat de kernboor over meer tanden beschikt en zo veel minder vlug slijtage vertoont.

Order nr.	790302502 M	790305002 M
Orig. nr.	HQS2523	HQS5023
Diameter	mm 12-13-14-15-16-17-18-19-20-21-22-23-24-25-26-27-28-29-30	mm 12-13-14-15-16-17-18-19-20-21-22-23-24-25-26-27-28-29-30
Omschrijving	Weldon 19	Weldon 19
Snijdiepte	mm 25	50
Prijs	€ 359,00	421,00

MACH



33-delige set HQ Metalworks kernboren van 12 tot 40 mm en 4 pilotpinnen met snijdieptes 25 of 50 mm.

Troeven:

- 3 keer vlugger boren dan met gewone boren
- Voorkom voorboren
- Werken aan hogere snijsnelheden
- Meerdere afmetingen onmiddellijk bij de hand

Geschikt voor:

- alle magneetboormachines met weldon opname (rekening houdend met diepte)
- servicewagens, installateur, etc.

Standaard geleverd met:

- in hoogwaardige, stevige kunststoffen koffer met inleg schuimrubber voor bescherming met inleg.
- 29 kernboren
- 4 pilotpinnen

Tip:

- Het gebruik van snijvloeistof is onmisbaar, want het werkelijk boren wordt aan een veel hogere voeding gedaan, omdat de kernboor over meer tanden beschikt en zo veel minder vlug slijtage vertoont.

Order nr.	790302504 M	790305004 M
Orig. nr.	HQS2533	HQS5033
Diameter	mm 12-13-14-15-16-17-18-19-20-21-22-23-24-25-26-27-28-29-30-31-32-33-34-35-36-37-38-39-40	mm 12-13-14-15-16-17-18-19-20-21-22-23-24-25-26-27-28-29-30-31-32-33-34-35-36-37-38-39-40
Omschrijving	Weldon 19	Weldon 19
Snijdiepte	mm 25	50
Prijs	€ 569,00	709,00



RED LINE

Kernboren met weldon opname 19.05 mm

Troeven:

- Hoog kwaliteitstaal
- Multicut geometrisch geslepen wat een lagere wrijvingscoëfficiënt genereert, garandeert zo een langere levensduur en betere spananafvoer.
- Weldon 19.05 mm, voor een vastere klemming, wat resulteert in een stabielere snede en een preciezere afwerking van de gaten.
- in snijdieptes van 25 of 50 mm.
- Iedere kernboor wordt individueel verpakt in een hoogwaardige kunststoffen koker.

Tip: vergeet uw centreerpin niet bij te bestellen.

Order nr.	Orig. nr.	Diameter mm	Snijdiepte mm	Prijs €
790302512	HQL2512	12	25	11,90
790302513	HQL2513	13	25	11,90
790302514	HQL2514	14	25	12,90
790302515	HQL2515	15	25	13,50
790302516	HQL2516	16	25	14,90
790302517	HQL2517	17	25	14,90
790302518	HQL2518	18	25	15,90
790302519	HQL2519	19	25	15,90
790302520	HQL2520	20	25	18,50
790302521	HQL2521	21	25	18,50
790302522	HQL2522	22	25	20,50
790302523	HQL2523	23	25	20,50
790302524	HQL2524	24	25	21,90
790302525	HQL2525	25	25	21,90
790302526	HQL2526	26	25	23,50
790302527	HQL2527	27	25	23,90
790302528	HQL2528	28	25	23,90
790302529	HQL2529	29	25	25,50
790302530	HQL2530	30	25	25,90
790302531	HQL2531	31	25	27,50
790302532	HQL2532	32	25	27,90
790302533	HQL2533	33	25	28,90
790302534	HQL2534	34	25	30,50
790302535	HQL2535	35	25	30,90
790302536	HQL2536	36	25	32,50
790302537	HQL2537	37	25	33,90
790302538	HQL2538	38	25	34,90
790302539	HQL2539	39	25	35,90
790302540	HQL2540	40	25	36,90
790302541	HQL2541	41	25	43,90
790302542	HQL2542	42	25	46,90
790302543	HQL2543	43	25	49,50
790302544	HQL2544	44	25	52,50
790302545	HQL2545	45	25	54,50
790302546	HQL2546	46	25	56,50
790302547	HQL2547	47	25	57,90
790302548	HQL2548	48	25	59,90
790302549	HQL2549	49	25	60,90
790302550	HQL2550	50	25	64,90
790302551	HQL2551	51	25	66,50
790302552	HQL2552	52	25	68,50
790302553	HQL2553	53	25	69,90
790302554	HQL2554	54	25	73,50
790302555	HQL2555	55	25	73,90
790302556	HQL2556	56	25	76,90
790302557	HQL2557	57	25	78,50
790302558	HQL2558	58	25	80,50
790302559	HQL2559	59	25	82,50
790302560	HQL2560	60	25	84,50
790302561	HQL2561	61	25	89,90
790302562	HQL2562	62	25	92,50
790302563	HQL2563	63	25	93,90
790302564	HQL2564	64	25	95,50
790302565	HQL2565	65	25	97,90
790305012	HQL5012	12	50	14,90
790305013	HQL5013	13	50	14,90
790305014	HQL5014	14	50	15,90
790305015	HQL5015	15	50	16,90
790305016	HQL5016	16	50	18,50
790305017	HQL5017	17	50	18,50
790305018	HQL5018	18	50	19,50
790305019	HQL5019	19	50	19,50
790305020	HQL5020	20	50	21,90
790305021	HQL5021	21	50	21,90
790305022	HQL5022	22	50	23,90
790305023	HQL5023	23	50	23,90
790305024	HQL5024	24	50	26,90
790305025	HQL5025	25	50	26,90
790305026	HQL5026	26	50	27,90
790305027	HQL5027	27	50	28,50
790305028	HQL5028	28	50	29,90
790305029	HQL5029	29	50	31,50
790305030	HQL5030	30	50	32,90
790305031	HQL5031	31	50	32,90
790305032	HQL5032	32	50	34,90
790305033	HQL5033	33	50	35,90
790305034	HQL5034	34	50	37,90
790305035	HQL5035	35	50	39,50
790305036	HQL5036	36	50	41,50
790305037	HQL5037	37	50	43,90
790305038	HQL5038	38	50	45,50
790305039	HQL5039	39	50	46,90
790305040	HQL5040	40	50	56,50
790305041	HQL5041	41	50	58,90
790305042	HQL5042	42	50	59,90
790305043	HQL5043	43	50	30,90
790305044	HQL5044	44	50	63,50
790305045	HQL5045	45	50	65,50
790305046	HQL5046	46	50	68,90
790305047	HQL5047	47	50	74,90
790305048	HQL5048	48	50	77,90
790305049	HQL5049	49	50	79,90
790305050	HQL5050	50	50	83,90
790305051	HQL5051	51	50	86,50
790305052	HQL5052	52	50	88,50
790305053	HQL5053	53	50	90,50
790305054	HQL5054	54	50	92,90
790305055	HQL5055	55	50	94,90
790305056	HQL5056	56	50	98,90
790305057	HQL5057	57	50	102,00
790305058	HQL5058	58	50	104,00
790305059	HQL5059	59	50	95,50
790305060	HQL5060	60	50	109,00
790305061	HQL5061	61	50	115,00
790305062	HQL5062	62	50	118,00
790305063	HQL5063	63	50	122,00
790305064	HQL5064	64	50	124,00
790305065	HQL5065	65	50	126,00



Pilootpin kernboren voor snijdieptes 25 en 50 mm.

Kenmerken:

- Afmetingen CPK25: 6,34/5,3x77mm
- Afmetingen CPL50: 6,34/5,3x102mm

Tip: gebruik telkens een pilootpin om te voorkomen dat er stukken afbreken van uw kernboren

Order nr.	790302600	M	790302601	M
Orig. nr.	CPK25		CPL50	
Snijdiepte	mm	25	50	
Prijs	€	5,00	5,70	

Vloeiboren



Set vloeiboren met kraag en draadtap FORM.

Tapgaten zonder speling? Te weinig materiaal om uw moer vast te kunnen maken op een buis? Het kan met vloeiboren.

Geen speling en niet meer meedraaien van moeren. Met een van volgende sets, hebt u een vloeiboer en een draadtap, type FORM, volgens de gewenste metrische draad..

FORM is het vloeiboren en het generen van een kraag. Een kraag kan nodig zijn als u werkt met dunwandige buizen en er te weinig materiaal voor handen is om voldoende draad te genereren.

Tip: Vergeet uw basis set KBSMK23, 713060005, niet te bestellen, als ook de pasta niet 713060090 en de tapolie 713060092.

Order nr.	Orig. nr.	Maat	Maximum aanbevolen materiaalsterkte	Prijs
		M	mm	€
713060024	SFORMSM4	4	1.5	119,00
713060025	SFORMSM5	5	2.0	126,00
713060026	SFORMSM6	6	2.0	137,00
713060028	SFORMSM8	8	2.5	161,00
713060030	SFORMSM10	10	2.5	191,00
713060032	SFORMSM12	12	3.0	222,00



Set vloeiboren zonder kraag en tap type CUT.

Tapgaten zonder speling? Het kan met vloeiboren.

Geen speling en niet meer meedraaien van moeren. Met een van volgende sets, hebt u een vloeiboer en een draadtap, type CUT, volgens de gewenste metrische draad..

CUT is het vloeiboren zonder een kraag. Een kraag kan nodig zijn als u werkt met dunwandige buizen en er te weinig materiaal voor handen is om voldoende draad te genereren, dan opteert u voor het type FORM, zie ordernr. 713060024 tot en met 713060032.

Tip: Vergeet uw basis set KBSMK23, 713060005, niet te bestellen, als ook de pasta niet 713060090 en de tapolie 713060092.

Order nr.	Orig. nr.	Maat	Maximum aanbevolen materiaalsterkte	Prijs
		M	mm	€
713060044	SCUTSM4	4	2.0	140,00
713060045	SCUTSM5	5	3.0	172,00
713060046	SCUTSM6	6	3.0	195,00
713060048	SCUTSM8	8	4.0	218,00
713060050	SCUTSM10	10	4.0	247,00
713060052	SCUTSM12	12	4.5	280,00



Basisset OPTIMUM Vloeiboren.

Standaard geleverd met:

- Haaksleutel
- Steeksleutel
- 4 spantangen Ø 6/ Ø 8/ Ø 10/ Ø 12 mm ER32
- Reductiehuls MK3 / MK2
- Koffer
- 100 gram vloeiboorpaste met borstel
- 100 ml tapolie met borstel
- Gereedschapshouder MK2/ ER32

Order nr.	713060005	M
Orig. nr.	3060005	
Prijs	€	268,00

Steenboren



4-delige set professionele Superior steenboren.

Troeven:

- Professionele steenboor DIN8039 met cilindrische schacht
- Hoogwaardige geslepen uitvoering voor vlugge stofverwijdering.
- Met gebraseerde top (tot 1100°C) voor lange standtijd
- Geschikt voor klopboormachines.
- Hoog rendement zelfs bij intensief gebruik
- Verpakt in een hoogwaardig kunststof opbergcassette.
- Ideaal voor het boren in stenen, beton en marmer.
- Ook beschikbaar in 7-8-12 dlj set op aanvraag.

Order nr.	742069040
Orig. nr.	DRBS4
Diameter	mm 5 - 6 - 8 - 10
Prijs	€ 10,90



Professionele steenboor DIN8039.

Troeven:

- Standaard lengte
- Snijhoek 130°.
- Hoogwaardige geslepen uitvoering met platte snijtop geschikt voor klopboormachines.
- Ideaal voor het boren in stenen, beton en marmer.
- Verpakt per stuk.

Order nr.	Orig. nr.	Diameter mm	Snijlengte mm	Totale lengte mm	Prijs €
742060400	DRB0400C	4	40	75	3,00
742060500	DRB0500C	5	45	85	3,10
742060600	DRB0600C	6	55	100	3,10
742060800	DRB0800C	8	65	100	4,00
742060900	DRB0900C	9	65	110	4,40
742061000	DRB1000C	10	65	120	4,60
742061200	DRB1200C	12	85	150	6,40
742061400	DRB1400C	14	85	150	10,90
742061600	DRB1600C	16	85	150	14,90
742061800	DRB1800C	18	89	160	16,90
742062000	DRB2000C	20	89	160	18,50



Professionele steenboor DIN8039.

Troeven:

- Lange versie.
- Hoogwaardige geslepen uitvoering met platte snijtop geschikt voor klopboormachines.
- Ideaal voor het boren in stenen, beton en marmer.
- Verpakt per stuk.

Order nr.	Orig. nr.	Diameter mm	Totale lengte mm	Prijs €
742061505	DRBL1505C	5	150	4,40
742061506	DRBL1506C	6	150	4,90
742062008	DRBL2008C	8	150	6,20
742062010	DRBL20010C	10	200	7,60
742062012	DRBL20012C	12	200	9,50
742064006	DRBL4006C	6	400	9,80
742064008	DRBL4008C	8	400	9,80
742064010	DRBL40010C	10	400	11,90
742064012	DRBL40012C	12	400	14,90



Professionele steenboor SDS-PLUS.

Troeven:

- Hoogwaardige geslepen uitvoering met speciale platte snijtop geschikt voor klopboormachines.
- Voorzien van de zelfspannende SDS-PLUS koppeling.
- Ideaal voor het boren in stenen, beton en marmer. Voor professioneel gebruik.
- Verpakt per stuk.

Order nr.	Orig. nr.	Diameter mm	Totale lengte mm	Prijs €
742001105	DSDS11005	5	110	3,30
742001106	DSDS11006	6	110	3,40
742001107	DSDS11007	7	110	3,70
742001108	DSDS11008	8	110	3,60
742001110	DSDS11010	10	110	4,20
742001605	DSDS16005	5	160	3,60
742001606	DSDS16006	6	160	3,70
742001608	DSDS16008	8	160	4,00
742001610	DSDS16010	10	160	4,50
742001612	DSDS16012	12	160	4,70
742001614	DSDS16014	14	160	6,60
742001616	DSDS16016	16	160	8,90
742002106	DSDS21006	6	210	4,60
742002108	DSDS21008	8	210	5,00
742002110	DSDS21010	10	210	5,60
742002112	DSDS21012	12	210	6,60
742002114	DSDS21014	14	210	7,70
742002116	DSDS21016	16	210	9,80
742002118	DSDS21018	18	210	12,50

Houtboren



6-delige speed-houtborensset.

Troeven:

- Korte uitvoering - lengte 150 mm
- Hardheid boorkop HRC 48 - 50
- Hexagonale (zeskant) 1/4 aansluiting
- Voor het boren in zacht en hard hout
- Verpakt in een hoogwaardig kunststof opbergcassette.

Order nr.	742110006
Orig. nr.	DRHSET
Maten	mm 10-12-16-18-20-25
Prijs	€ 16,50

Puntlasboren



Puntlasboor HSS-CO volgens DIN1897

Troeven:

- Freesboor voor het verwijderen van hardnekkige puntlassen
- Met aangepaste punt volgens DIN1412/E
- Cobaltuitvoering
- Cilindrische schacht

Geschikt voor:

- Boormachines voor algemeen verwijderen van puntlassen

Order nr.	Orig. nr.	Diameter mm	Totale lengte mm	Prijs €
748297106	DRSP06	6	68	16,50
748297107	DRSP07	7	74	18,50
748297108	DRSP08	8	79	19,50
748297110	DRSP10	10	89	24,90



Puntlasfrees HSS-CO

Troeven:

- Freesboor voor het verwijderen van hardnekkige puntlassen
- Aangepast punt volgens DIN1412/E
- Cobaltuitvoering

Geschikt voor:

- Pneumatische puntlasfreesmachines
- Aircraft SF Pro

Order nr.	748310650	748310800	748310810
Orig. nr.	DRSPCO65	DRSPCO80	DRSPCO80V
Diameter	mm 6,5	8	8 vario
Prijs	€ 18,50	21,50	21,50



Puntlasfrees HSS-CO met TiN coating.

Troeven:

- Freesboor voor het verwijderen van hardnekkige puntlassen
- Met aangepaste punt volgens DIN1412/E
- Cobaltuitvoering
- TiN coating (Titanium Nitride) helpt met het verlagen van de temperatuur geassocieerd met het snijproces en verlengt de levensduur

Geschikt voor:

- Pneumatische puntlasfreesmachines
- Aircraft SF Pro

Order nr.	748311650	748311800	748311810
Orig. nr.	DRSPTI65	DRSPTI80	DRSPTI80V
Diameter	mm 6,5	8	8 vario
Prijs	€ 23,90	26,90	26,90

Cirkelzaagbladen

metall-raft



TCT cirkelzaagbladen.

Troeven:

- Snel zagen
- Japans Wolframcarbide staal
- Voorzien van extra harde HM-zaagtanden
- Snijden is mogelijk zonder koelmiddel
- Zaagbladen kunnen geslepen worden

Geschikt voor:

- Elk type sneldraaiende afkortzaag
- HKS230 / MTS356

Order nr.	Diameter mm	Asgat mm	Dikte mm	Aantal tanden	Voor type	Voor	Prijs €
713850231	230	25.4	2	48	HKS230	staal	79,90
713850233	230	25.4	1.8	60	HKS230	inox	99,90
713850232	230	25.4	2.4	80	HKS230	alu	70,90
713853504	355	25.4	2.4	80	MTS355-MTS356	staal	161,00
713853503	355	25.4	2.4	90	MTS355-MTS356	inox	195,00
713853502	355	25.4	2.4	80	MTS355-MTS356	alu	179,00

MACH



Afkort cirkelzaagbladen.

Troeven:

- In HSS en DM05 kwaliteit, zwart geoxideerde zaagbladen
- Meeneemgaten type :
 - I : 2/8/45+2/9/50+2/11/63
 - II : 2/8/56+4/12/64

Geschikt voor:

- Metaal afkortzaagmachines

Order nr.	Diameter mm	Asgat mm	Dikte mm	Tandsteek T	Aantal tanden	Meeneem- gaten	Voor type	Kwaliteit	Voor	Prijs €
713652250	225	32	2	8	90	I	MKS225	HSS DM05	staal	71,50
713652251	225	32	2	6	120	I	MKS225	HSS DM05	staal	71,50
713652252	225	32	2	5	140	I	MKS225	HSS DM05	staal	71,50
713652253	225	32	2	4	180	I	MKS225	HSS DM05	staal	71,50
713652254	225	32	2	3	220	I	MKS225	HSS DM05	staal	71,50
713652506	250	32	2	6	128	I	MKS250-255	HSS DM05	staal	74,90
713652505	250	32	2	5	160	I	MKS250-255	HSS DM05	staal	74,90
713652504	250	32	2	4	200	I	MKS250-255	HSS DM05	staal	74,90
713652758	275	32	2.5	8	110	I	MKS275	HSS DM05	staal	101,00
713652756	275	32	2.5	6	140	I	MKS275	HSS DM05	staal	104,00
748191910	275	32	2.5	5	180	I	MKS275	HSS DM05	staal	104,00
713652754	275	32	2.5	4	220	I	MKS275	HSS DM05	staal	104,00
713357448	275	40	2.5	8	110	II	CS275	HSS DM05	staal	104,00
713357446	275	40	2.5	6	140	II	CS275	HSS DM05	staal	105,00
748191809	275	40	2.5	5	180	II	CS275	HSS DM05	staal	104,00
713357444	275	40	2.5	4	220	II	CS275	HSS DM05	staal	104,00
713653008	300	32	2.5	8	120	I	MKS315	HSS DM05	staal	126,00
713653006	300	32	2.5	6	160	I	MKS315	HSS DM05	staal	126,00
748192516	300	32	2.5	5	180	I	MKS315	HSS DM05	staal	126,00
713653004	300	32	2.5	4	220	I	MKS315	HSS DM05	staal	126,00
713653158	315	32	2.5	8	120	I	MKS315	HSS DM05	staal	135,00
713653156	315	32	2.5	6	160	I	MKS315	HSS DM05	staal	135,00
713653154	315	32	2.5	4	240	I	MKS315	HSS DM05	staal	135,00
713357458	315	40	2.5	8	120	II	CS315	HSS DM05	staal	148,00
713357456	315	40	2.5	6	160	II	CS315	HSS DM05	staal	148,00
713357454	315	40	2.5	4	240	II	CS315	HSS DM05	staal	143,00
713653506	350	32	2.5	6	180	I	MKS350	HSS DM05	staal	172,00
713653504	350	32	3	4	280	I	MKS350	HSS DM05	staal	172,00

metall-wafl



Afkortzaagbladen specifiek voor aluminium

Troeven:

- Uiterst geschikt voor het zagen van Aluminium.
- Negatieve spaanhoek voor het zagen van buizen en profielen.
- Hardmetalen tanden.

Geschikt voor:

- Alu afkortzagen

Order nr.	Diameter mm	Asgat mm	Dikte mm	Aantal tanden	Voor type	Kwaliteit	Voor	Prijs €
713650400	400	32	4	60	LMS400	Widia vertanding	alu	217,00
713654048	400	32	4	96	LMS400	Widia vertanding	alu	237,00
713654049	400	32	3	84	LMS400	Widia vertanding	alu	224,00

Klokszagen/gatzagen

MACH



13-delige set gatzagen van 19-64 mm in een hoogwaardige kunststofkoffer inclusief assen en koppelstuk.

Troeven:

- Kwaliteit HSS bimetaal M3
- Max. snijdiepte: 30 mm (1 3/8)
- Variabele vertanding van de gatzagen zorgt voor een vlugger en efficiënter zagen van ijzer, staal, aluminium, messing, koper, gietijzer, roestvrij staal, hout, plastic, fiberglas, etc.

Geleverd met:

- 9 gat / klokszagen:
 - 19 - 3/4"
 - 22 - 7/8"
 - 29 - 1-1/8"
 - 35 - 1-3/8"
 - 38 - 1-1/2"
 - 44 - 1-3/4"
 - 51 - 2"
 - 57 - 2-1/4"
 - 64 - 2-1/2"
- 1 Hexagonale geleidingsas 8,5 mm met pilootboor - voor klokszagen $\varnothing \leq 30$ mm
- 1 Hexagonale geleidingsas 8,5 mm met pilootboor - voor klokszagen $\varnothing \geq 30$ mm
- 1 Adapterrings
- 1 Pilootboor $\varnothing 6,35 \times 80$ mm
- Met toerentabel voor de verschillende materialen
- Hoogwaardige kunststofkoffer

Tip: Het is aangeraden om bij metalen een gepaste snijolie te gebruiken.

Order nr.	748261964 		
Orig. nr.	HSSET1964		
Klokszagen diameter	mm	19 · 22 · 29 · 35 · 38 · 44 · 51 · 57 · 64	
Prijs	€	99,90	

MACHINES



HSS-bimetaal gatzagen. Voor toepassing in metalen, non-ferro metalen, pvc en hout.

Troeven:

- Kwaliteit HSS bimetaal M3
- Max. snijdiepte: 30 mm (1 3/8)
- Variabele vertanding van de gatzagen zorgt voor een vlugger en efficiënter zagen van ijzer, staal, aluminium, messing, koper, gietijzer, roestvrij staal, hout, plastic, fiberglas, etc.
- Verpakt per stuk.

Geschikt voor:

- Metalen, non-ferro metalen, pvc en hout

Tip: Het is aangeraden om bij metalen een gepaste snijolie te gebruiken.

Order nr.	Orig. nr.	Maat mm	Prijs €
748260016	HSBI16	16	9,00
748260017	HSBI17	17	9,80
748260019	HSBI19	19	9,80
748260020	HSBI20	20	9,80
748260021	HSBI21	21	9,80
748260022	HSBI22	22	10,50
748260024	HSBI24	24	9,80
748260025	HSBI25	25	10,50
748260027	HSBI27	27	10,90
748260029	HSBI29	29	10,90
748260030	HSBI30	30	12,90
748260032	HSBI32	32	10,90
748260033	HSBI33	33	10,90
748260035	HSBI35	35	12,50
748260037	HSBI37	37	12,50
748260038	HSBI38	38	12,50
748260040	HSBI40	40	12,90
748260041	HSBI41	41	12,90
748260043	HSBI43	43	12,90
748260044	HSBI44	44	16,50
748260046	HSBI46	46	13,90
748260048	HSBI48	48	13,90
748260051	HSBI51	51	14,90
748260052	HSBI52	52	16,90
748260054	HSBI54	54	16,90
748260057	HSBI57	57	16,90
748260059	HSBI59	59	16,90
748260060	HSBI60	60	16,90
748260064	HSBI64	64	18,50
748260065	HSBI65	65	18,50
748260067	HSBI67	67	18,50
748260068	HSBI68	68	23,90
748260070	HSBI70	70	23,90
748260073	HSBI73	73	18,50
748260076	HSBI76	76	22,90
748260079	HSBI79	79	19,50
748260083	HSBI83	83	20,50
748260086	HSBI86	86	28,50
748260089	HSBI89	89	20,50
748260092	HSBI92	92	23,50
748260095	HSBI95	95	24,90
748260098	HSBI98	98	25,90
748260102	HSBI102	102	27,90
748260105	HSBI105	105	35,90
748260108	HSBI108	108	38,90
748260111	HSBI111	111	39,90
748260114	HSBI114	114	43,90
748260121	HSBI121	121	49,50
748260127	HSBI127	127	52,50
748260140	HSBI140	140	62,90
748260152	HSBI152	152	73,50



As voor gatzagen van ø 14 tot 30 mm.

Troeven:

- Aansluiting hexagonaal 8,5 mm
- Voor het opnemen van gatzagen van ø 14 tot 30 mm

Geleverd met:

- Centerboor.

Order nr.	748261430		
Orig. nr.	HSAR1430		
Aansluiting	mm	HEX 8,5	
Voor klokzagen diameter	mm	14-30	
Prijs	€	11,90	



As voor monteren van gatzagen van ø 32 tot 152 mm.

Troeven:

- Aansluiting hexagonaal 8,5 mm
- Voor het opnemen van gatzagen van ø 32 tot 152 mm

Geleverd met:

- Centerboor

Order nr.	748263152		
Orig. nr.	HSAR32152		
Aansluiting	mm	HEX 9,5	
Voor klokzagen diameter	mm	32-152	
Prijs	€	20,50	



As voor monteren van gatzagen van ø 32 tot 152 mm, SDS Plus aansluiting..

Troeven:

- Aansluiting SDS Plus (bvb. klopboormachines)
- Voor het opnemen van gatzagen van ø 32 tot 152 mm

Geleverd met:

- Centerboor

Order nr.	748264152		
Orig. nr.	748264152		
Aansluiting		SDS-plus	
Voor klokzagen diameter	mm	32-152	
Prijs	€	29,90	



Centreerboor voor assen bij gatzagen, diameter 6,35 x lengte 100 mm

Geschikt voor:

- 748263152 en 748261430

Tip: Gebruik telkens een centreerboor bij gatzagen, zo wordt u gatzaag correct geleid in het materiaal.

Order nr.	748269200		
Orig. nr.	HSSD63510		
VE	5		
Prijs/VE	€	26,50	



Centreerboor voor assen bij gatzagen, diameter 6,35 x lengte 80 mm

Geschikt voor:

- 748264152

Tip: Gebruik telkens een centreerboor bij gatzagen, zo wordt u gatzaag correct geleid in het materiaal.

Order nr.	748269201		
Orig. nr.	HSSD63580		
VE	5		
Prijs/VE	€	25,90	

Lintzaagbladen

ROL VAR







Bandzaag op rol Matrix 30M in verschillende hoogtes

Troeven:

- Matrix Bi-metaal zaagblad, algemeen zaagblad voor algemene toepassingen
- Stillere en minder vibraties
- Gematigde kost per zaagsnede
- Met variabele fijne vertanding 0°
- Verschillende hoogtes en diktes

Geschikt voor:

- Verticale metaal bandzaagmachines
- onderbroken zaagsnedes: buizen, hoekprofielen
- Koolstofstaal, constructiestaal
- onderhoudswerkplaatsen, doe-het-zelver, scholen, etc.





Order nr.	Orig. nr.	Lengte m	Hoogte mm	Breedte mm	Vertanding Tpi	Prijs €
713655020 	713655020	30	6	0,65	10-14	192,00
713655021 	713655021	30	10	0,65	10-14	215,00
713655022 	713655022	30	13	0,65	10-14	215,00
713655023 	713655023	30	13	0,90	10-14	226,00
713655024 	713655024	30	16	0,90	10-14	237,00

13x0,65 VAST

Lintzaagbladen HSS 13 x 0.65 met vaste vertanding

Troeven:

- HSS kwaliteit
- Gelaste zaag
- Hoogte 13 x dikte 0,65 mm
- Vaste vertanding grof 6T of fijn 14T

Order nr.	Orig. nr.	Lengte mm	Hoogte mm	Breedte mm	Kwaliteit	Vertanding Tpi	Voor type	Prijs €
713351106 	3351106	1470	13	0,65	HSS	6	S100G	7,60
713351114 	3351114	1470	13	0,65	HSS	14	S100G	18,90
713351513 	3351513	1638	13	0,65	HSS	6	S121G-S130GH-S131GH	11,50
713351514 	3351514	1638	13	0,65	HSS	14	S121G-S130GH-S131GH	10,90



13x0,65 VAST VAR

Lintzaagbladen Matrix 13 x 0,65 met vaste of variabele vertanding

Troeven:

- Matrix Bi-metaal zaagblad, algemeen zaagblad voor algemene toepassingen
- Stiller en minder vibraties
- Gematigde kost per zaagsnede
- Met variabele vertanding 0° of vaste vertanding.
- Hoogte 13 x dikte 0,65 mm

Geschikt voor:

- kleine en middelgrote zaagmachines
- onderbroken zaagsnedes: buizen, hoekprofielen
- Koolstofstaal, constructiestaal
- onderhoudswerkplaatsen, doe-het-zelver, scholen, etc.

Order nr.	Orig. nr.	Lengte mm	Hoogte mm	Breedte mm	Kwaliteit	Vertanding Tpi	Voor type	Prijs €
713351509 M	3351509	1300	13	0,5	Bi-metaal	10-14	S91G	16,90
713351109 M	3351109	1470	13	0,65		6-10		17,90
713351110 M	3351110	1470	13	0,65	Bi-metaal	10-14	S100G	17,90
713351511 M	3351511	1638	13	0,65	Bi-metaal	6	S121G-S130GH-S131GH	18,90
713351512 M	3351512	1638	13	0,65	Bi-metaal	6-10	S121G-S130GH-S131GH	19,90
713351518 M	3351518	1638	13	0,65	Bi-metaal	10-14	S121G-S130GH-S131GH	19,90
713650011 M	3650011	1335	13	0,65	Bi-metaal	6-10	MBS85	17,50
713650012 M	3650012	1335	13	0,65	Bi-metaal	10-14	MBS85	17,50
713650013 M	3650013	1440	13	0,65	Bi-metaal	6	MBS125	17,90
713650014 M	3650014	1440	13	0,65	Bi-metaal	6-10	MBS125	19,90
713650015 M	3650015	1440	13	0,65	Bi-metaal	10-14	MBS125	18,90
713650016 M	3650016	1735	13	0,65	Bi-metaal	5-8	MBS150-155R	19,90
790025550 M	790025550	1138	13	0,65		10-14		15,90



13x0,9 VAR

Lintzaagbladen Matrix 13 x 0,90 met variabele vertanding

Troeven:

- Matrix Bi-metaal zaagblad, algemeen zaagblad voor algemene toepassingen
- Stiller en minder vibraties
- Gematigde kost per zaagsnede
- Met variabele vertanding 0°.
- Hoogte 13 x dikte 0,90 mm

Geschikt voor:

- kleine en middelgrote zaagmachines
- onderbroken zaagsnedes: buizen, hoekprofielen
- Koolstofstaal, constructiestaal
- onderhoudswerkplaatsen, doe-het-zelver, scholen, etc.

Order nr.	Orig. nr.	Lengte mm	Hoogte mm	Breedte mm	Kwaliteit	Vertanding Tpi	Voor type	Prijs €
713351522 M	3351522	1735	13	0,9	M42 Bi-metaal	6-10	S150G	20,90
713357538 M	3357538	1735	13	0,9	M42 Bi-metaal	10-14	S150G	20,90



20x0,9 VAR



Lintzaagbladen M42 20 x 0,90 met variabele vertanding

Troeven:

- M42 Bi-metaal zaagblad, HSS met 8% Cobalt
- Deze Bi-metaal zaagbladen bieden een verhoogde productiviteit.
- Gelaste bandzaag
- Met variabele vertanding 0°
- Hoogte 20 x dikte 0,90 mm

Geschikt voor:

- Middelgrote tot grote zaagmachines
- Volle materialen en sterk geribde structuren
- Staallegeringen, gietstaal, bepaalde roestvrij stalen, Carbon staal.
- Algemene industrie, metaal werkplaatsen

Order nr.	Orig. nr.	Lengte mm	Hoogte mm	Breedte mm	Kwaliteit	Vertanding Tpi	Voor type	VE	Min. bestelhoeveelheid	Prijs/VE €
790008002	790008002	2060	20	0,9	M42	5-8	MACC (SPECIAL 215) - PEGAS (150x200 MAN)	1	5	25,50
790008001	790008001	2060	20	0,9	M42	6-10	MACC (SPECIAL 215) - PEGAS (150x200 MAN)	1	5	25,50
790008000	790008000	2060	20	0,9	M42	10-14	MACC (SPECIAL 215) - PEGAS (150x200 MAN)	1	5	25,50
713357514	3357514	2080	20	0,9	M42	6-10	UZAY MAKINA (UMS 150 G, UMSY 150 G)	1	5	26,50
713357515	3357515	2080	20	0,9	M42	10-14	UZAY MAKINA (UMS 150 G, UMSY 150 G)	1	5	26,50
790008009	790008009	2095	20	0,9	M42	5-8	IMET (GBS 185 e GH)	1	5	26,50
790008008	790008008	2095	20	0,9	M42	6-10	IMET (GBS 185 e GH)	1	5	26,50
790008007	790008007	2095	20	0,9	M42	10-14	IMET (GBS 185 e GH)	1	5	26,50
713357519	3357519	2362	20	0,9	M42	10	S181-S181G/GG	1	5	26,90
713357518	3357518	2362	20	0,9	M42	14	S181-S181G/GG	1	5	26,90
713357522	3357522	2362	20	0,9	M42	5-8	S181-S181G/GG	1	5	26,90
713357521	3357521	2362	20	0,9	M42	6-10	S181-S181G/GG	1	5	26,90
713357520	3357520	2362	20	0,9	M42	10-14	S181-S181G/GG	1	5	26,90
790008013	790008013	2400	20	0,9	M42	4-6	SIERRASABI (BR160/220)	1	5	27,90
790008012	790008012	2400	20	0,9	M42	5-8	SIERRASABI (BR160/220)	1	5	27,90
790008011	790008011	2400	20	0,9	M42	6-10	SIERRASABI (BR160/220)	1	5	27,90
790008010	790008010	2400	20	0,9	M42	10-14	SIERRASABI (BR160/220)	1	5	27,90
790008028	790008028	2490	20	0,9	M42	3-4	MEBA (200) - PILOUS (ARG200, ARG200PLUS)	1	5	28,90
790008027	790008027	2490	20	0,9	M42	4-6	MEBA (200) - PILOUS (ARG200, ARG200PLUS)	1	5	28,90
790008026	790008026	2490	20	0,9	M42	5-8	MEBA (200) - PILOUS (ARG200, ARG200PLUS)	1	5	28,90
790008025	790008025	2490	20	0,9	M42	6-10	MEBA (200) - PILOUS (ARG200, ARG200PLUS)	1	5	28,90
790008024	790008024	2490	20	0,9	M42	10-14	MEBA (200) - PILOUS (ARG200, ARG200PLUS)	1	5	28,90
790008044	790008044	2630	20	0,9	M42	3-4	IMET (BASIC 230/60 e GH)	1	5	30,50
790008043	790008043	2630	20	0,9	M42	4-6	IMET (BASIC 230/60 e GH)	1	5	30,50
790008042	790008042	2630	20	0,9	M42	5-8	IMET (BASIC 230/60 e GH)	1	5	30,50
790008041	790008041	2630	20	0,9	M42	6-10	IMET (BASIC 230/60 e GH)	1	5	30,50
790008040	790008040	2630	20	0,9	M42	10-14	IMET (BASIC 230/60 e GH)	1	5	30,50



27x0,9 VAR

Lintzaagbladen M42 27 x 0,90 met variabele vertanding

Troeven:

- M42 Bi-metaal zaagblad, HSS met 8% Cobalt
- Deze Bi-metaal zaagbladen bieden een verhoogde productiviteit.
- Gelaste bandzaag
- Met variabele vertanding 0°
- Hoogte 27 x dikte 0,90 mm

Geschikt voor:

- Middelgrote tot grote zaagmachines
- Volle materialen en sterk geribde structuren
- Staallegeringen, gietstaal, bepaalde roestvrij stalen, Carbon staal.
- Algemene industrie, metaal werkplaatsen

Order nr.	Orig. nr.	Lengte mm	Hoogte mm	Breedte mm	Kwaliteit	Vertanding Tpi	Voor type	VE Min. bestelhoe- veelheid	Prijs/VE €	
790008018	790008018	2450	27	0,9	M42	3-4	MACC (SPECIAL 280, 280CSO, 285M, 285CSO, 285MS) - FMB (200A, 250D, 250DP, 200DS, 250SA, 250SA Piping) - MEBA (220 G) - CARIF (260MB, 260BSA, 260BA CNC) - PEGAS (220x250 MAN, GH)	1	5	29,50
790008017	790008017	2450	27	0,9	M42	4-6	MACC (SPECIAL 280, 280CSO, 285M, 285CSO, 285MS) - FMB (200A, 250D, 250DP, 200DS, 250SA, 250SA Piping) - MEBA (220 G) - CARIF (260MB, 260BSA, 260BA CNC) - PEGAS (220x250 MAN, GH)	1	5	29,50
790008016	790008016	2450	27	0,9	M42	5-8	MACC (SPECIAL 280, 280CSO, 285M, 285CSO, 285MS) - FMB (200A, 250D, 250DP, 200DS, 250SA, 250SA Piping) - MEBA (220 G) - CARIF (260MB, 260BSA, 260BA CNC) - PEGAS (220x250 MAN, GH)	1	5	29,50
790008015	790008015	2450	27	0,9	M42	6-10	MACC (SPECIAL 280, 280CSO, 285M, 285CSO, 285MS) - FMB (200A, 250D, 250DP, 200DS, 250SA, 250SA Piping) - MEBA (220 G) - CARIF (260MB, 260BSA, 260BA CNC) - PEGAS (220x250 MAN, GH)	1	5	29,50
790008014	790008014	2450	27	0,9	M42	10-14	MACC (SPECIAL 280, 280CSO, 285M, 285CSO, 285MS) - FMB (200A, 250D, 250DP, 200DS, 250SA, 250SA Piping) - MEBA (220 G) - CARIF (260MB, 260BSA, 260BA CNC) - PEGAS (220x250 MAN, GH)	1	5	29,50
713357528	3357528	2460	27	0,9	M42	6-10	S275G-S285DG (2005)	1	5	29,50
713357529	3357529	2460	27	0,9	M42	10-14	S275G-S285DG (2005)	1	5	29,50
713357526	3357526	2480	27	0,9	M42	4-6	S275G-S285DG	1	5	29,50
713357511	3357511	2480	27	0,9	M42	5-8	S275G-S285DG	1	5	29,50
713357524	3357524	2480	27	0,9	M42	6-10	S275G-S285DG	1	5	30,50
790010200	790010200	2480	27	0,9	M42	8-12	S275G-S285DG	1	5	29,50
713357525	3357525	2480	27	0,9	M42	10-14	S275G-S285DG	1	5	29,50
790008034	790008034	2590	27	0,9	M42	3-4	RAIMONDI (22SAR)	1	5	29,50
790008033	790008033	2590	27	0,9	M42	4-6	RAIMONDI (22SAR)	1	5	29,50
790008032	790008032	2590	27	0,9	M42	5-8	RAIMONDI (22SAR)	1	5	29,50
790008031	790008031	2590	27	0,9	M42	6-10	RAIMONDI (22SAR)	1	5	30,50
790008030	790008030	2590	27	0,9	M42	10-14	RAIMONDI (22SAR)	1	5	29,50
790008039	790008039	2600	27	0,9	M42	3-4	PILOUS (ARG220PLUS)	1	5	30,90
790008038	790008038	2600	27	0,9	M42	4-6	PILOUS (ARG220PLUS)	1	5	30,90
790008037	790008037	2600	27	0,9	M42	5-8	PILOUS (ARG220PLUS)	1	5	30,90
790008036	790008036	2600	27	0,9	M42	6-10	PILOUS (ARG220PLUS)	1	5	30,90
790008035	790008035	2600	27	0,9	M42	10-14	PILOUS (ARG220PLUS)	1	5	30,90

Order nr.	Orig. nr.	Lengte mm	Hoogte mm	Breedte mm	Kwaliteit	Vertanding Tpi	Voor type	VE		Min. bestelhoe- veelheid	Prijs/VE €
								1	5		
790008049	790008049	2700	27	0,9	M42	3-4	BEHRINGER (SLB 230 G, SLB 230 DG, SLB 230 DG-Halbbautomat) - FMB (Triton 280D, Antilia 280DP, Antares 280DS, Orion 310D+S, Uranus 310D+S-P, Sirius 280SA, Omega 310D, S-SA, Centauro, Cynus, Calipaso, Pulsar) - MEBA (230 G/DG/DG-P/GA-P/GA-H/GA-NC) - PILOUS (ARG250STANDARD(H), ARG250PLUS(H), ARG, AUTOMAT)	1	5	30,90	
790008048	790008048	2700	27	0,9	M42	4-6	BEHRINGER (SLB 230 G, SLB 230 DG, SLB 230 DG-Halbbautomat) - FMB (Triton 280D, Antilia 280DP, Antares 280DS, Orion 310D+S, Uranus 310D+S-P, Sirius 280SA, Omega 310D, S-SA, Centauro, Cynus, Calipaso, Pulsar) - MEBA (230 G/DG/DG-P/GA-P/GA-H/GA-NC) - PILOUS (ARG250STANDARD(H), ARG250PLUS(H), ARG, AUTOMAT)	1	5	30,90	
790008047	790008047	2700	27	0,9	M42	5-8	BEHRINGER (SLB 230 G, SLB 230 DG, SLB 230 DG-Halbbautomat) - FMB (Triton 280D, Antilia 280DP, Antares 280DS, Orion 310D+S, Uranus 310D+S-P, Sirius 280SA, Omega 310D, S-SA, Centauro, Cynus, Calipaso, Pulsar) - MEBA (230 G/DG/DG-P/GA-P/GA-H/GA-NC) - PILOUS (ARG250STANDARD(H), ARG250PLUS(H), ARG, AUTOMAT)	1	5	30,90	
790008046	790008046	2700	27	0,9	M42	6-10	BEHRINGER (SLB 230 G, SLB 230 DG, SLB 230 DG-Halbbautomat) - FMB (Triton 280D, Antilia 280DP, Antares 280DS, Orion 310D+S, Uranus 310D+S-P, Sirius 280SA, Omega 310D, S-SA, Centauro, Cynus, Calipaso, Pulsar) - MEBA (230 G/DG/DG-P/GA-P/GA-H/GA-NC) - PILOUS (ARG250STANDARD(H), ARG250PLUS(H), ARG, AUTOMAT)	1	5	30,90	
790008045	790008045	2700	27	0,9	M42	10-14	BEHRINGER (SLB 230 G, SLB 230 DG, SLB 230 DG-Halbbautomat) - FMB (Triton 280D, Antilia 280DP, Antares 280DS, Orion 310D+S, Uranus 310D+S-P, Sirius 280SA, Omega 310D, S-SA, Centauro, Cynus, Calipaso, Pulsar) - MEBA (230 G/DG/DG-P/GA-P/GA-H/GA-NC) - PILOUS (ARG250STANDARD(H), ARG250PLUS(H), ARG, AUTOMAT)	1	5	30,90	
713655604	3655604	2720	27	0,9	M42	3-4 Tpi		1	5	31,90	
713655606	3655606	2720	27	0,9	M42	4-6 Tpi		1	5	31,90	
713655508	3655508	2720	27	0,9	M42	5-8 Tpi		1	5	31,90	
790600112	790600112	2720	27	0,9		6-10		1	5	31,90	
713655509	3655509	2720	27	0,9		10-14		1	5	31,90	
790008057	790008057	2750	27	0,9	M42	3-4	MEP (260, 260 MA)	1	5	32,50	
790007288	790007288	2750	27	0,9	M42	4-6	MEP (260, 260 MA)	1	5	32,50	
713357752	3357752	2750	27	0,9	M42	5-8	S290-S300DG-S310DG	1	5	32,50	
713357751	3357751	2750	27	0,9	M42	5-8	MEP (260, 260 MA)	1	5	32,50	
713357753	3357753	2750	27	0,9	M42	6-10	MEP (260, 260 MA)	1	5	32,50	
790008053	790008053	2750	27	0,9	M42	10-14	MEP (260, 260 MA)	1	5	32,50	
790008062	790008062	2770	27	0,9	M42	3-4	IMET (BS 300/60, BS 300/60 SH, BS 300 PLUS GH, BS 300 PLUS SHI, BS 300/60 GH, BS 300 PLUS, BS 300 PLUS SH, BS 300/60 AFIE, BS 300/60 AFHNC)	1	5	32,50	
790008061	790008061	2770	27	0,9	M42	4-6	IMET (BS 300/60, BS 300/60 SH, BS 300 PLUS GH, BS 300 PLUS SHI, BS 300/60 GH, BS 300 PLUS, BS 300 PLUS SH, BS 300/60 AFIE, BS 300/60 AFHNC)	1	5	32,50	
790008060	790008060	2770	27	0,9	M42	5-8	IMET (BS 300/60, BS 300/60 SH, BS 300 PLUS GH, BS 300 PLUS SHI, BS 300/60 GH, BS 300 PLUS, BS 300 PLUS SH, BS 300/60 AFIE, BS 300/60 AFHNC)	1	5	32,50	
790008059	790008059	2770	27	0,9	M42	6-10	IMET (BS 300/60, BS 300/60 SH, BS 300 PLUS GH, BS 300 PLUS SHI, BS 300/60 GH, BS 300 PLUS, BS 300 PLUS SH, BS 300/60 AFIE, BS 300/60 AFHNC)	1	5	32,50	
790008058	790008058	2770	27	0,9	M42	10-14	IMET (BS 300/60, BS 300/60 SH, BS 300 PLUS GH, BS 300 PLUS SHI, BS 300/60 GH, BS 300 PLUS, BS 300 PLUS SH, BS 300/60 AFIE, BS 300/60 AFHNC)	1	5	32,50	
790008072	790008072	2910	27	0,9	M42	6-10	KASTO (Funktional M/U/P/A)	1	5	33,50	
790008067	790008067	2825	27	0,9	M42	3-4	MACC (SPECIAL 301M, 301CSO, 301M/S, 315A, 320M, 320M/S, 320CSO) - MEBA (220 DG) - PEGAS (250x315 GH) - MEP (280, 280 MA, 280 SXI)	1	5	32,50	
790008066	790008066	2825	27	0,9	M42	4-6	MACC (SPECIAL 301M, 301CSO, 301M/S, 315A, 320M, 320M/S, 320CSO) - MEBA (220 DG) - PEGAS (250x315 GH) - MEP (280, 280 MA, 280 SXI)	1	5	32,50	
790008065	790008065	2825	27	0,9	M42	5-8	MACC (SPECIAL 301M, 301CSO, 301M/S, 315A, 320M, 320M/S, 320CSO) - MEBA (220 DG) - PEGAS (250x315 GH) - MEP (280, 280 MA, 280 SXI)	1	5	32,50	
790008064	790008064	2825	27	0,9	M42	6-10	MACC (SPECIAL 301M, 301CSO, 301M/S, 315A, 320M, 320M/S, 320CSO) - MEBA (220 DG) - PEGAS (250x315 GH) - MEP (280, 280 MA, 280 SXI)	1	5	32,50	

Zaagbladen en klokzagen

Order nr.	Orig. nr.	Lengte mm	Hoogte mm	Breedte mm	Kwaliteit	Veranding Tpi	Voor type	VE Min. bestelhoe- Prijs-/VE veelheid		€
								1	5	
790008063	790008063	2825	27	0,9	M42	10-14	MACC (SPECIAL 301M, 301CSO, 301M/S, 315A, 320M, 320M/S, 320CSO) - MEBA (220 DG) - PEGAS (250x315 GH) - MEP (280, 280 MA, 280 SXI)	1	5	32,50
790008075	790008075	2910	27	0,9	M42	3-4	KASTO (Funktional M/U/P/A)	1	5	33,50
790008074	790008074	2910	27	0,9	M42	4-6	KASTO (Funktional M/U/P/A)	1	5	33,50
790008073	790008073	2910	27	0,9	M42	5-8	KASTO (Funktional M/U/P/A)	1	5	33,50
790008071	790008071	2910	27	0,9	M42	10-14	KASTO (Funktional M/U/P/A)	1	5	33,50
790008080	790008080	2925	27	0,9	M42	3-4	SIERRASABI (BR 240/320, BR 240/320 M, BR 240/320 H)	1	5	33,50
713357540	3357540	2925	27	0,9	M42	4-6	SIERRASABI (BR 240/320, BR 240/320 M, BR 240/320 H)	1	5	33,50
713357541	3357541	2925	27	0,9	M42	5-8	SIERRASABI (BR 240/320, BR 240/320 M, BR 240/320 H)	1	5	33,50
713357542	3357542	2925	27	0,9	M42	6-10	SIERRASABI (BR 240/320, BR 240/320 M, BR 240/320 H)	1	5	33,50
713357543	3357543	2925	27	0,9	M42	10-14	SIERRASABI (BR 240/320, BR 240/320 M, BR 240/320 H)	1	5	33,50
790008085	790008085	2950	27	0,9	M42	3-4	MEP (280 SX)	1	5	33,50
790008084	790008084	2950	27	0,9	M42	4-6	MEP (280 SX)	1	5	33,50
790008083	790008083	2950	27	0,9	M42	5-8	MEP (280 SX)	1	5	33,50
790008082	790008082	2950	27	0,9	M42	6-10	MEP (280 SX)	1	5	33,50
790008081	790008081	2950	27	0,9	M42	10-14	MEP (280 SX)	1	5	33,50
713655115	3655115	2980	27	0,9	M42	2-3	PEGAS (240x280 GH, 240x280 A-CNC)	1	5	33,50
713655013	3655013	2980	27	0,9	M42	3-4	PEGAS (240x280 GH, 240x280 A-CNC)	1	5	33,50
713655116	3655116	2980	27	0,9	M42	4-6	PEGAS (240x280 GH, 240x280 A-CNC)	1	5	33,50
713655206	3655206	2980	27	0,9	M42	5-8	PEGAS (240x280 GH, 240x280 A-CNC)	1	5	33,50
790008087	790008087	2980	27	0,9	M42	6-10	PEGAS (240x280 GH, 240x280 A-CNC)	1	5	33,50
790008086	790008086	2980	27	0,9	M42	10-14	PEGAS (240x280 GH, 240x280 A-CNC)	1	5	33,50
790008093	790008093	3000	27	0,9	M42	3-4	KARMETAL (KMT220KDG) - UZAY MAKINA (UMSY 220 G) - METALWORKS	1	5	33,50
790008094	790008094	3000	27	0,9	M42	4-6	KARMETAL (KMT220KDG) - UZAY MAKINA (UMSY 220 G) - METALWORKS	1	5	33,50
713612308	3612308	3000	27	0,9	M42	5-8	KARMETAL (KMT220KDG) - UZAY MAKINA (UMSY 220 G) - METALWORKS	1	5	33,50
713612310	3612310	3000	27	0,9	M42	6-10	KARMETAL (KMT220KDG) - UZAY MAKINA (UMSY 220 G) - METALWORKS	1	5	33,50
713612314	3612314	3000	27	0,9	M42	10-14	KARMETAL (KMT220KDG) - UZAY MAKINA (UMSY 220 G)	1	5	33,50
790008101	790008101	3020	27	0,9	M42	3-4	MEBA (180) - CARIF (320BSA, 320BA CNC)	1	5	33,50
790008100	790008100	3020	27	0,9	M42	4-6	MEBA (180) - CARIF (320BSA, 320BA CNC)	1	5	33,50
790008099	790008099	3020	27	0,9	M42	5-8	MEBA (180) - CARIF (320BSA, 320BA CNC)	1	5	33,50
790008098	790008098	3020	27	0,9	M42	6-10	MEBA (180) - CARIF (320BSA, 320BA CNC)	1	5	33,50
713655100	3655100	3100	27	0,9	M42	2-3	BMBS290-S300DG-S310DGx320-BMBS290-S300DG-S310DGx290	1	5	34,90
713655000	3655000	3100	27	0,9	M42	3-4	IMET (BASIC 270/60 e GH) - PEGAS (290x320 GH, 290x290 A-CNC) - PILOUS (ARG300STANDARD(H), ARG300PLUS(H), ARG, AUTOMAT)	1	5	34,90
790008105	790008105	3100	27	0,9	M42	4-6	IMET (BASIC 270/60 e GH) - PEGAS (290x320 GH, 290x290 A-CNC) - PILOUS (ARG300STANDARD(H), ARG300PLUS(H), ARG, AUTOMAT)	1	5	34,90
713655200	3655200	3100	27	0,9	M42	5-8	IMET (BASIC 270/60 e GH) - PEGAS (290x320 GH, 290x290 A-CNC) - PILOUS (ARG300STANDARD(H), ARG300PLUS(H), ARG, AUTOMAT)	1	5	34,90
790008103	790008103	3100	27	0,9	M42	6-10	IMET (BASIC 270/60 e GH) - PEGAS (290x320 GH, 290x290 A-CNC) - PILOUS (ARG300STANDARD(H), ARG300PLUS(H), ARG, AUTOMAT)	1	5	34,90
790008112	790008112	3150	27	0,9	M42	3-4	MEP (320, 320 AX, 320 AXI, 320 CNC, 320 MA, 320 SX, 320 SXI, 330 CNCFE)	1	5	34,90
790008111	790008111	3150	27	0,9	M42	4-6	MEP (320, 320 AX, 320 AXI, 320 CNC, 320 MA, 320 SX, 320 SXI, 330 CNCFE)	1	5	34,90
790008110	790008110	3150	27	0,9	M42	5-8	MEP (320, 320 AX, 320 AXI, 320 CNC, 320 MA, 320 SX, 320 SXI, 330 CNCFE)	1	5	34,90
790008109	790008109	3150	27	0,9	M42	6-10	MEP (320, 320 AX, 320 AXI, 320 CNC, 320 MA, 320 SX, 320 SXI, 330 CNCFE)	1	5	34,90
790008116	790008116	3180	27	0,9	M42	3-4	BEHRINGER (SLB 240 A, SLB 240 A/G, SLB 240 G-Halbbautomat)	1	5	34,90
790008115	790008115	3180	27	0,9	M42	4-6	BEHRINGER (SLB 240 A, SLB 240 A/G, SLB 240 G-Halbbautomat)	1	5	34,90
790008114	790008114	3180	27	0,9	M42	5-8	BEHRINGER (SLB 240 A, SLB 240 A/G, SLB 240 G-Halbbautomat)	1	5	34,90
790008113	790008113	3180	27	0,9	M42	6-10	BEHRINGER (SLB 240 A, SLB 240 A/G, SLB 240 G-Halbbautomat)	1	5	34,90
713357530	3357530	3352	27	0,9	M42	4-6	S300VG	1	5	37,50

Order nr.	Orig. nr.	Lengte	Hoogte	Breedte	Kwaliteit	Vertanding	Voor type	VE Min. bestelhoe-Prijs/VE veelheid		
								mm	mm	mm
713357531	3357531	3352	27	0,9	M42	5-8	S300VG	1	5	37,50
713357532	3357532	3352	27	0,9	M42	6-10	S300VG	1	5	37,50
790008120	790008120	3420	27	0,9	M42	3-4	FMB (Galactica 400SAV)	1	5	37,50
790008119	790008119	3420	27	0,9	M42	4-6	FMB (Galactica 400SAV)	1	5	37,50
790008118	790008118	3420	27	0,9	M42	5-8	FMB (Galactica 400SAV)	1	5	37,50
790008117	790008117	3420	27	0,9	M42	6-10	FMB (Galactica 400SAV)	1	5	37,50
790008124	790008124	3505	27	0,9	M42	3-4	AMADA (H-250 SA, HA-250, HDA-250, HFA-250)	1	5	37,50
790008123	790008123	3505	27	0,9	M42	4-6	AMADA (H-250 SA, HA-250, HDA-250, HFA-250)	1	5	37,50
790008122	790008122	3505	27	0,9	M42	5-8	AMADA (H-250 SA, HA-250, HDA-250, HFA-250)	1	5	37,50
790008121	790008121	3505	27	0,9	M42	6-10	AMADA (H-250 SA, HA-250, HDA-250, HFA-250) UZAY MAKINA (UMSY 280, UMS 280, UMSO 280,	1	5	37,50
790008129	790008129	3660	27	0,9	M42	3-4	UMSO 280H) - AMADA (CRH-300 S, CHA-300 S) - MEBA (251, 251 A, 301 G, 301 GA)	1	5	39,90
790008128	790008128	3660	27	0,9	M42	4-6	UZAY MAKINA (UMSY 280, UMS 280, UMSO 280, UMSO 280H) - AMADA (CRH-300 S, CHA-300 S) - MEBA (251, 251 A, 301 G, 301 GA)	1	5	39,90
790008127	790008127	3660	27	0,9	M42	5-8	UZAY MAKINA (UMSY 280, UMS 280, UMSO 280, UMSO 280H) - AMADA (CRH-300 S, CHA-300 S) - MEBA (251, 251 A, 301 G, 301 GA)	1	5	39,90
790008126	790008126	3660	27	0,9	M42	6-10	UZAY MAKINA (UMSY 280, UMS 280, UMSO 280, UMSO 280H) - AMADA (CRH-300 S, CHA-300 S) - MEBA (251, 251 A, 301 G, 301 GA)	1	5	39,90
790008139	790008139	3720	27	0,9	M42	3-4	BEHRINGER (HBP 220, HBP 220 A)	1	5	39,90
790008138	790008138	3720	27	0,9	M42	4-6	BEHRINGER (HBP 220, HBP 220 A)	1	5	39,90
790008137	790008137	3720	27	0,9	M42	5-8	BEHRINGER (HBP 220, HBP 220 A)	1	5	39,90
790008136	790008136	3720	27	0,9	M42	6-10	BEHRINGER (HBP 220, HBP 220 A)	1	5	39,90
790008146	790008146	3800	27	0,9	M42	3-4	MEBA (270, 270 A, 305 G, 305 DG, 305 GA, 250 A, 250, 320) - SIERRASABI (BR 260)	1	5	39,90
790008145	790008145	3800	27	0,9	M42	4-6	MEBA (270, 270 A, 305 G, 305 DG, 305 GA, 250 A, 250, 320) - SIERRASABI (BR 260)	1	5	39,90
790008144	790008144	3800	27	0,9	M42	5-8	MEBA (270, 270 A, 305 G, 305 DG, 305 GA, 250 A, 250, 320) - SIERRASABI (BR 260)	1	5	39,90
790008154	790008154	3850	27	0,9	M42	3-4	KARMETAL (KMT300)	1	5	41,50
790008153	790008153	3850	27	0,9	M42	4-6	KARMETAL (KMT300)	1	5	41,50
790008152	790008152	3850	27	0,9	M42	5-8	KARMETAL (KMT300)	1	5	41,50
790008151	790008151	3850	27	0,9	M42	6-10	KARMETAL (KMT300)	1	5	42,90
790008173	790008173	4200	27	0,9	M42	5-8	MEBA (310 DG, ECO 320 G/GA)	1	5	41,50
790008174	790008174	4200	27	0,9	M42	4-6	MEBA (310 DG, ECO 320 G/GA)	1	5	43,90
790008175	790008175	4200	27	0,9	M42	3-4	MEBA (310 DG, ECO 320 G/GA)	1	5	43,90
790008185	790008185	4310	27	0,9	M42	5-8	KASTO (SBA 260/400 U/G, BSM 260/400 B/G)	1	5	45,50
790008186	790008186	4310	27	0,9	M42	4-6	KASTO (SBA 260/400 U/G, BSM 260/400 B/G)	1	5	45,50
790008187	790008187	4310	27	0,9	M42	3-4	KASTO (SBA 260/400 U/G, BSM 260/400 B/G)	1	5	45,50
790008200	790008200	4570	27	0,9	M42	5-8	SIERRASABI (PSR 320)	1	5	46,50
790008201	790008201	4570	27	0,9	M42	4-6	SIERRASABI (PSR 320)	1	5	46,50
790008202	790008202	4570	27	0,9	M42	3-4	SIERRASABI (PSR 320)	1	5	46,50
790008231	790008231	4980	27	0,9	M42	3-4	FMB (Pluton 1 1200SAV)	1	5	50,50
790008230	790008230	4980	27	0,9	M42	4-6	FMB (Pluton 1 1200SAV)	1	5	50,50
790008229	790008229	4980	27	0,9	M42	5-8	FMB (Pluton 1 1200SAV)	1	5	50,50

MACHINES



Lintzaagbladen M42 34 x 1,10 met variabele vertanding

Troeven:

- M42 Bi-metaal zaagblad, HSS met 8% Cobalt
- Deze Bi-metaal zaagbladen bieden een verhoogde productiviteit.
- Gelaste bandzaag
- Met variabele vertanding 0°
- Hoogte 34 x dikte 1,10 mm

Geschikt voor:

- Middelgrote tot grote zaagmachines
- Volle materialen en sterk geribde structuren
- Staallegeringen, gietstaal, bepaalde roestvrij stalen, Carbon staal.
- Algemene industrie, metaal werkplaatsen

Order nr.	Orig. nr.	Lengte mm	Hoogte mm	Breedte mm	Kwaliteit	Vertanding Tpi	Voor type	VE	Min. bestel- hoeveelheid	Prijs/VE €
790008135	790008135	3660	34	1,1	M42	3-4	CARIF (450BSA, 450BA CNC)	1	5	48,90
790008134	790008134	3660	34	1,1	M42	4-6	CARIF (450BSA, 450BA CNC)	1	5	48,90
790008133	790008133	3660	34	1,1	M42	5-8	CARIF (450BSA, 450BA CNC)	1	5	48,90
790008132	790008132	3660	34	1,1	M42	6-10	CARIF (450BSA, 450BA CNC)	1	5	48,90
790008143	790008143	3720	34	1,1	M42	3-4	BEHRINGER (HBP 220, HBP 220 A)	1	5	48,90
790008142	790008142	3720	34	1,1	M42	4-6	BEHRINGER (HBP 220, HBP 220 A)	1	5	48,90
790008141	790008141	3720	34	1,1	M42	5-8	BEHRINGER (HBP 220, HBP 220 A)	1	5	48,90
790008140	790008140	3720	34	1,1	M42	6-10	BEHRINGER (HBP 220, HBP 220 A)	1	5	48,90
790008150	790008150	3800	34	1,1	M42	3-4	MEBA (300 A, 310 GA, 310 G, 320, 320 A, 325)	1	5	48,90
790008149	790008149	3800	34	1,1	M42	4-6	MEBA (300 A, 310 GA, 310 G, 320, 320 A, 325)	1	5	48,90
790008148	790008148	3800	34	1,1	M42	5-8	MEBA (300 A, 310 GA, 310 G, 320, 320 A, 325)	1	5	48,90
790008157	790008157	3885	34	1,1	M42	3-4	AMADA (HK 400)	1	5	50,90
790008156	790008156	3885	34	1,1	M42	4-6	AMADA (HK 400)	1	5	50,90
790008155	790008155	3885	34	1,1	M42	5-8	AMADA (HK 400)	1	5	50,90
790008160	790008160	3910	34	1,1	M42	3-4	KARMETAL (KMT 300 WOS) - KASTO (SSB 260 VA to serial no. 106)	1	5	50,90
790008159	790008159	3910	34	1,1	M42	4-6	KARMETAL (KMT 300 WOS) - KASTO (SSB 260 VA to serial no. 106)	1	5	50,90
790008158	790008158	3910	34	1,1	M42	5-8	KARMETAL (KMT 300 WOS) - KASTO (SSB 260 VA to serial no. 106)	1	5	50,90
790008164	790008164	4030	34	1,1	M42	3-4	IMET (BS 400 SHI)	1	5	52,50
790008163	790008163	4030	34	1,1	M42	4-6	IMET (BS 400 SHI)	1	5	52,50
790008162	790008162	4030	34	1,1	M42	5-8	IMET (BS 400 SHI)	1	5	52,50
790008167	790008167	4100	34	1,1	M42	3-4	BEHRINGER (HBP 260 A)	1	5	52,50
790008166	790008166	4100	34	1,1	M42	4-6	BEHRINGER (HBP 260 A)	1	5	52,50
790008165	790008165	4100	34	1,1	M42	5-8	BEHRINGER (HBP 260 A)	1	5	52,50
790008178	790008178	4200	34	1,1	M42	3-4	MEBA (260 A, 280, 280 A, 310 G-L, 310 GA-L, 320 DG, 320 DGA, ECO 320 G/GA variable)	1	5	53,90
790008177	790008177	4200	34	1,1	M42	4-6	MEBA (260 A, 280, 280 A, 310 G-L, 310 GA-L, 320 DG, 320 DGA, ECO 320 G/GA variable)	1	5	53,90
790008176	790008176	4200	34	1,1	M42	5-8	MEBA (260 A, 280, 280 A, 310 G-L, 310 GA-L, 320 DG, 320 DGA, ECO 320 G/GA variable)	1	5	53,90
790008181	790008181	4260	34	1,1	M42	3-4	UZAY MAKINA (UMSY 330, UMSY 330 G, UMSO 330, UMSO 330 DG)	1	5	53,90
790008180	790008180	4260	34	1,1	M42	4-6	UZAY MAKINA (UMSY 330, UMSY 330 G, UMSO 330, UMSO 330 DG)	1	5	53,90
790008179	790008179	4260	34	1,1	M42	5-8	UZAY MAKINA (UMSY 330, UMSY 330 G, UMSO 330, UMSO 330 DG)	1	5	53,90
790008184	790008184	4300	34	1,1	M42	3-4	PILOUS (ARG400PLUS SAF)	1	5	55,90
790008183	790008183	4300	34	1,1	M42	4-6	PILOUS (ARG400PLUS SAF)	1	5	55,90
790008182	790008182	4300	34	1,1	M42	5-8	PILOUS (ARG400PLUS SAF)	1	5	55,90
790008188	790008188	4350	34	1,1	M42	2-3	KARMETAL (KMT350KDG)	1	1	55,90
790008189	790008189	4350	34	1,1	M42	3-4	KARMETAL (KMT350KDG)	1	1	55,90
790008190	790008190	4350	34	1,1	M42	4-6	KARMETAL (KMT350KDG)	1	1	55,90
790008193	790008193	4400	34	1,1	M42	3-4	MEBA (ECO 320 DG/DGA, ECO 335/335 A/G/GA, DG/DGA-1300-3300)	1	5	55,90
790008192	790008192	4400	34	1,1	M42	4-6	MEBA (ECO 320 DG/DGA, ECO 335/335 A/G/GA, DG/DGA-1300-3300)	1	5	55,90

Order nr.	Orig. nr.	Lengte mm	Hoogte mm	Breedte mm	Kwaliteit	Vertanding Tpi	Voor type	VE	Min. bestel- hoeveelheid	Prijs/VE €
790008191	790008191	4400	34	1,1	M42	5-8	MEBA (ECO 320 DG/DGA, ECO 335/335 A/G/GA, DG/DGA-1300-3300)	1	5	55,90
790008196	790008196	4440	34	1,1	M42	3-4	SIERRASABI (BR 350)	1	5	55,90
790008195	790008195	4440	34	1,1	M42	4-6	SIERRASABI (BR 350)	1	5	55,90
790008194	790008194	4440	34	1,1	M42	5-8	SIERRASABI (BR 350)	1	5	55,90
713655101	3655101	4520	34	1,1	M42	2-3	BMBS350x400-HMBS350x400	1	5	57,50
713655001	3655001	4520	34	1,1	M42	3-4	PEGAS (350x400 SHI, 350x400 A-CNC, 350x400 H)	1	5	57,50
790008198	790008198	4520	34	1,1	M42	4-6	PEGAS (350x400 SHI, 350x400 A-CNC, 350x400 H)	1	5	57,50
713655201	3655201	4520	34	1,1	M42	5-8	PEGAS (350x400 SHI, 350x400 A-CNC, 350x400 H)	1	5	57,50
790008205	790008205	4570	34	1,1	M42	3-4	AMADA (HA-400, HFA-400) - UZAY MAKINA (UMSY-350, UMSO 350)	1	5	57,50
790008204	790008204	4570	34	1,1	M42	4-6	AMADA (HA-400, HFA-400) - UZAY MAKINA (UMSY-350, UMSO 350)	1	5	57,50
790008203	790008203	4570	34	1,1	M42	5-8	AMADA (HA-400, HFA-400) - UZAY MAKINA (UMSY-350, UMSO 350)	1	5	57,50
790008212	790008212	4610	34	1,1	M42	3-4	MACC (SPECIAL 420DI)	1	5	58,90
790008211	790008211	4610	34	1,1	M42	4-6	MACC (SPECIAL 420DI)	1	5	58,90
790008210	790008210	4610	34	1,1	M42	5-8	MACC (SPECIAL 420DI)	1	5	58,90
790008219	790008219	4670	34	1,1	M42	3-4	BEHRINGER (340, 340 A)	1	5	58,90
790008218	790008218	4670	34	1,1	M42	4-6	BEHRINGER (340, 340 A)	1	5	58,90
790008217	790008217	4670	34	1,1	M42	5-8	BEHRINGER (340, 340 A)	1	5	58,90
790008222	790008222	4780	34	1,1	M42	3-4	PEGAS (360x500 GH)	1	5	60,90
790008221	790008221	4780	34	1,1	M42	4-6	PEGAS (360x500 GH)	1	5	60,90
790008220	790008220	4780	34	1,1	M42	5-8	PEGAS (360x500 GH)	1	5	60,90
790008225	790008225	4860	34	1,1	M42	3-4	BEHRINGER (HBP 320, HBP 320 A, HBP 340, HBP 340 A, HBP 340 G)	1	5	60,90
790008224	790008224	4860	34	1,1	M42	4-6	BEHRINGER (HBP 320, HBP 320 A, HBP 340, HBP 340 A, HBP 340 G)	1	5	60,90
790008223	790008223	4860	34	1,1	M42	5-8	BEHRINGER (HBP 320, HBP 320 A, HBP 340, HBP 340 A, HBP 340 G)	1	5	60,90
790008228	790008228	4930	34	1,1	M42	3-4	KASTO (CUT GE 3, CUT GU 3, POS GA 2, POS GA 3, POS A 2, POS A 3)	1	5	62,50
790008227	790008227	4930	34	1,1	M42	4-6	KASTO (CUT GE 3, CUT GU 3, POS GA 2, POS GA 3, POS A 2, POS A 3)	1	5	62,50
790008226	790008226	4930	34	1,1	M42	5-8	KASTO (CUT GE 3, CUT GU 3, POS GA 2, POS GA 3, POS A 2, POS A 3)	1	5	62,50
790008234	790008234	5000	34	1,1	M42	3-4	BEHRINGER (HBP 313 G, HBP 310/523 G, HBP 310/403 GA, HBP 313 A)	1	5	62,50
790008233	790008233	5000	34	1,1	M42	4-6	BEHRINGER (HBP 313 G, HBP 310/523 G, HBP 310/403 GA, HBP 313 A)	1	5	62,50
790008232	790008232	5000	34	1,1	M42	5-8	BEHRINGER (HBP 313 G, HBP 310/523 G, HBP 310/403 GA, HBP 313 A)	1	5	62,50
790008237	790008237	5020	34	1,1	M42	3-4	FMB (Pluton 2)	1	5	62,50
790008236	790008236	5020	34	1,1	M42	4-6	FMB (Pluton 2)	1	5	62,50
790008235	790008235	5020	34	1,1	M42	5-8	FMB (Pluton 2)	1	5	62,50
713655005	3655005	5720	34	1,1	M42	3-4	HMBS440x600	1	5	121,00
713655105	3655105	5720	34	1,1	M42	2-3	HMBS440x600	1	5	121,00
713655205	3655205	5720	34	1,1	M42	5-8	HMBS440x600	1	5	121,00

ZAAGBLADEN

Een passend zaagblad voor jouw machine

VYNCKIER biedt zaagbladen aan in verschillende maten voor diverse types en soorten machines, zoals cirkelzagen, afkortzagen en lintzaagmachines. Afhankelijk van het materiaal dat je wil zagen (staal, inox, aluminium, ...), zorgen wij voor het perfecte zaagblad!

De juiste vertanding

Bij lintzaagbladen leidt het gebruik van de juiste vertanding tot efficiënt zagen tegen de laagste kostprijs. De vertanding is het aantal tanden per duim (25,4 mm) (TPI). Als algemene regel geldt: hoe korter de snijlengte, hoe fijner de gekozen vertanding, hoe groter de snijlengte, hoe groter de vertanding. Een te kleine vertanding kan leiden tot zaagverloop, omdat de spanen de zaaggroeven verstoppen en het zaagblad uit zijn zaagsnede gedwongen wordt. Een te grote vertanding kan leiden tot tandbreuk, doordat de druk op een tand te groot wordt. Minimum 3 tanden moeten ingrijpen, om tot een aanvaardbaar resultaat te komen. De juiste vertanding wordt bepaald door de dikte en vorm van het werkstuk. Maak gebruik van onze selectietabel.

Inlopen van zaagbladen

Het correct inlopen van een zaagblad garandeert een lange levensduur van voor uw lintzaagbladen. Scherpe snijkanten met een kleine kantradius zijn noodzakelijk. Belangrijk bij nieuwe zaagbladen. Vergelijk een nieuw zaagblad met een vers geslepen potlood: ze hebben extreem scherpe tanden die moeten worden ingebroken voor een optimaal gebruik. Dit kan door de daalsnelheid met 50% te verminderen tijdens de eerste 50 tot 100 sneden, en daarna langzaam op te drijven tot de normale waarde. Nieuwe zaagbladen kunnen in het begin vibraties en trilingsgeluiden voortbrengen. Indien dit gebeurt, moeten zaagsnelheid en/of daalsnelheid worden verminderd.

Lintzaagbladen: de verschillende kwaliteiten

We bieden verschillende kwaliteiten aan bij lintzaagbladen: M42 Bi-metaal, Achiever Bi-metaal, Challenger en Matrix.

- M42 Bi-metaal heeft een hoge duurzaamheid en maakt sneller verzagen mogelijk van volle materialen en dikwandige profielen. Lintzaagbladen van deze kwaliteit zijn geschikt om staallegeringen te zagen, gietstaal en carbon staal.
- ACHIEVER Bi-metaal lintzaagbladen zijn zaagbladen met excellente duurzaamheid en betrouwbaarheid in normale en moeilijke materiaalsoorten. ACHIEVER lintzaagbladen worden onder andere ingezet voor verzagen van grote bundels volmetaal en grote profielen of balken, zoals staallegeringen, gietstaal, carbon staal, gereedschapstaal, gehard staal, non-ferro metalen, brons en koper, aluminium en inox. Het beste zaagresultaat voor vele verschillende soorten materialen.
- Challenger lintzagen zijn speciaal ontworpen voor constructiestaal. Ze hebben een nog stevigere structuur en kracht om bundels te zagen. Geschikt voor carbon, aluminium, gelegerde metalen en constructiestaal te zagen.
- Matrix zijn goede lintzaagbladen voor algemene doeleinden. Deze zaagbladen zijn geschikt voor lichte tot middelzware productie-zagen of onderhoudstoepassingen. Matrix wordt onder andere gebruikt om carbon en constructiestaal te zagen.

TIP: maak je werkstuk vast

Het te bewerken werkstuk moet vast worden opgespannen, zodat het zich niet kan verdraaien of vibreren. Gebruik geen beschadigde, gebogen of sterk vervormde werkstukken. Hoe dichter de zaagbladgeleidingen zich tegen het stuk bevinden, hoe exacter de zaagsnede. Vul de machineklem niet helemaal, maar blijf een stuk onder de opgegeven capaciteit van de zaagmachine. Dit zal de efficiëntie verhogen, en levensduur van de zaagbladen verlengen. Bij het verzagen van bundels, is het soms vereist om met bovenklemming te werken, zoals hieronder weergegeven:

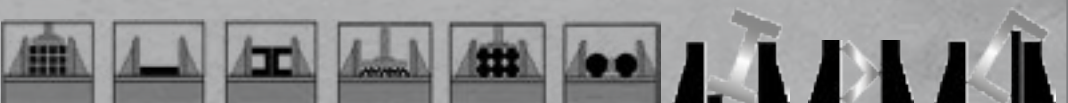

KIES UW ZAAGBLAD

Keuze van de vertanding:

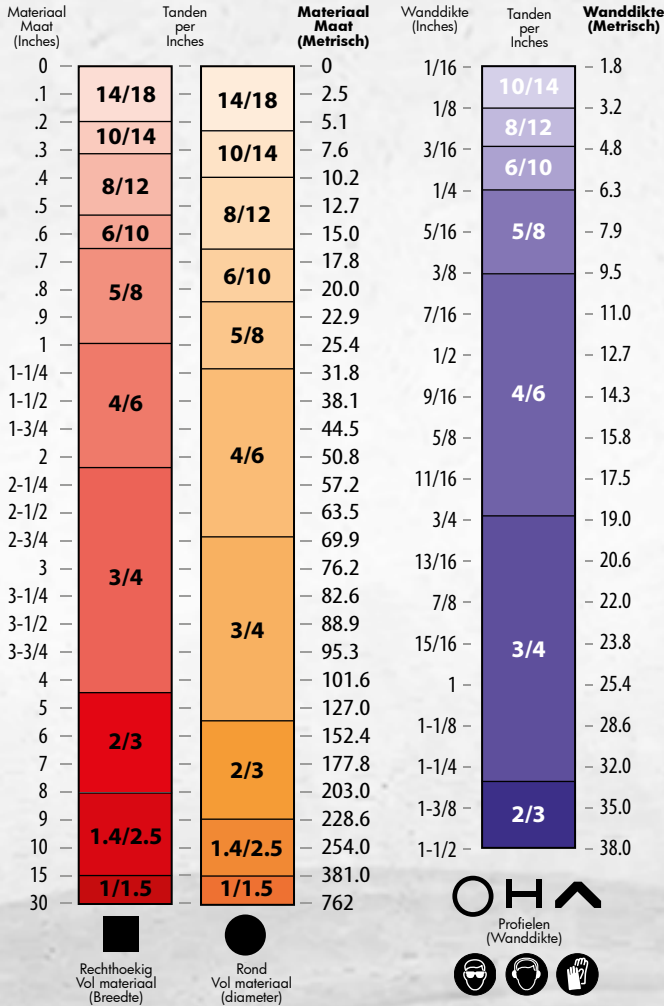

Keuze van het type blad:

	CARBON STEELS	STRUCTURAL STEELS	ALUMINUM & LT. ALLOY STEELS	ALLOY STEELS MOLD STEELS	TOOL STEELS	STAINLESS STEELS
AISI	1010, 1020, 1045	A36	6061, 2011, 2024, 5052	4140, P20	A2, H13, S7 M-SERIES	316, 304 17-4 PH., 15-5 PH
JIS	S20C, S45C		6061, 2011, 2024, 5052	SCM 440(H), SCM 445(H)	SHD11, SHD12, SKD61, SKS41	SUS316, SUS304
DIN	Ck45, C16.8		AlCuPb, AlCuMg2, AlMg2Mn0.3	41CrMo4	X155CrVMoV51, (G)X40CrMoV51	X5CrNiMo18 10, X5CrNi18 10

MATRIX II

M42

THE ACHIEVER™

Schuurbanden

50x1000



Universele schuurband voor de metaal- en houtbewerking

Troeven:

- Breedte 50 mm x lengte 1000 mm
- Verschillende korrels mogelijk: 40 - 60 - 80 - 100
- Linnendrager
- Aluminium oxide
- Uitstekende prijs-kwaliteitsverhouding

Geschikt voor:

- algemeen metaal en houtwerk
- het bewerken van randen en gelijke afname
- BTS51 of gelijkaardige slijpmachines met gelijke maatvoering.

Tip: dienen per korrelsoort per 10 stuks aangekocht te worden

Order nr.	Orig. nr.	Lengte mm	Breedte mm	Korrel K	Voor type	VE	Min. bestelhoeveelheid	Afmetingen (l x b x h) mm	Prijs/VE €
713721004 	3721004	1000	50	40	Metallkraft BTS50/51	1	10	50 x 1000 x 0	2,70
713721006 	3721006	1000	50	60	Metallkraft BTS50/51	1	10	50 x 1000 x 0	2,60
713721008 	3721008	1000	50	80	Metallkraft BTS50/51	1	10	50 x 1000 x 0	2,50
713721010 	3721010	1000	50	100	Metallkraft BTS50/51	1	10	50 x 1000 x 0	2,50

75x762



Universele schuurband voor de metaal- en houtbewerking





Troeven:

- Breedte 75 mm x lengte 762 mm
- Verschillende korrels mogelijk: 40 - 60 - 80 - 120
- Linnendrager
- Aluminium oxide
- Uitstekende prijs-kwaliteitsverhouding

Geschikt voor:

- algemeen metaal en houtwerk
- het bewerken van randen en gelijke afname
- SM200SL, GU20S of slijpmachines met gelijke maatvoering.

Tip: dienen per korrelsoort per 10 stuks aangekocht te worden

Order nr.	Orig. nr.	Lengte mm	Breedte mm	Korrel K	VE	Min. bestelhoeveelheid	Afmetingen (l x b x h) mm	Prijs/VE €
713357612 	3357612	762	75	40	1	10	150 x 150 x 75	3,20
713357614 	3357614	762	75	60	1	10	150 x 150 x 75	3,00
713357616 	3357616	762	75	80	1	10	150 x 150 x 75	3,00
713357618 	3357618	762	75	120	1	10	150 x 150 x 75	2,90

75x1016



Universele schuurband voor de metaal- en houtbewerking





Troeven:

- Breedte 75 mm x lengte 1016 mm
- Verschillende korrels mogelijk: 40 - 60 - 80 - 120
- Linnendrager
- Aluminium oxide
- Uitstekende prijs-kwaliteitsverhouding

Geschikt voor:

- algemeen metaal en houtwerk
- het bewerken van randen en gelijke afname
- SM250SL, GU25S of slijpmachines met gelijke maatvoering.

Tip: dienen per korrelsoort per 10 stuks aangekocht te worden

Order nr.	Orig. nr.	Lengte mm	Breedte mm	Korrel K	VE	Min. bestelhoeveelheid	Afmetingen (l x b x h) mm	Prijs/VE €
713357682 	3357682	1016	75	40	1	10	75 x 1016 x 0	4,10
713357684 	3357684	1016	75	60	1	10	75 x 1016 x 0	3,80
713357686 	3357686	1016	75	80	1	10	75 x 1016 x 0	3,80
713357688 	3357688	1016	75	120	1	10	75 x 1016 x 0	3,60

75x1180

Universele schuurband voor de metaal- en houtbewerking

Troeven:

- Breedte 75 mm x lengte 1180 mm
- Verschillende korrels mogelijk: 40 - 60 - 80 - 120
- Linnendrager
- Aluminium oxide
- Uitstekende prijs-kwaliteitsverhouding

Geschikt voor:

- algemeen metaal en houtwerk
- het bewerken van randen en gelijke afname
- DBS75 of slijpmachines met gelijke maatvoering.

Tip: dienen per korrelsoort per 10 stuks aangekocht te worden

Order nr.	Orig. nr.	Lengte mm	Breedte mm	Korrel K	Voor type	VE	Min. bestelhoeveelheid	Afmetingen (l x b x h) mm	Prijs/VE €
713357622	3357622	1180	75	40	Optimum DBS75	1	10	160 x 120 x 75	7,80
713357624	3357624	1180	75	60	Optimum DBS75	1	10	160 x 120 x 75	7,60
713357626	3357626	1180	75	80	Optimum DBS75	1	10	160 x 120 x 75	7,50
713357628	3357628	1180	75	120	Optimum DBS75	1	10	160 x 120 x 75	7,40

75x2000

Universele schuurband voor de metaal- en houtbewerking

Troeven:

- Breedte 75 mm x lengte 2000 mm
- Verschillende korrels mogelijk: 40 - 60 - 80 - 120
- Linnendrager
- Aluminium oxide
- Uitstekende prijs-kwaliteitsverhouding

Geschikt voor:

- algemeen metaal en houtwerk
- het bewerken van randen en gelijke afname
- BSM75 / BS75200 / MBSM75 of slijpmachines met gelijke maatvoering.

Tip: dienen per korrelsoort per 10 stuks aangekocht te worden

Order nr.	Orig. nr.	Lengte mm	Breedte mm	Korrel K	Voor type	VE	Min. bestelhoeveelheid	Afmetingen (l x b x h) mm	Prijs/VE €
713357642	3357642	2000	75	40	BSM75 BS75200	1	10	75 x 2000 x 0	7,40
713357644	3357644	2000	75	60	BSM75 BS75200	1	10	75 x 2000 x 0	7,10
713357646	3357646	2000	75	80	BSM75 BS75200	1	10	75 x 2000 x 0	6,70
713357648	3357648	2000	75	120	BSM75 BS75200	1	10	75 x 2000 x 0	6,50



Universele schuurband op rol voor de houtbewerking

80x50.000

Troeven:

- Breedte 80 mm x lengte 50.000 mm
- Verschillende korrels mogelijk: 60 - 80 - 100 - 120 - 150 - 180 - 220
- Linnendrager
- Aluminium oxide
- Uitstekende prijs-kwaliteitsverhouding

Geschikt voor:

- algemeen houtwerk
- het bewerken van randen en gelijke afname
- Holzstar ZSM405 of slijpmachines met gelijke maatvoering.

Order nr.	Orig. nr.	Lengte mm	Breedte mm	Korrel K	Type	Afmetingen (l x b x h) mm	Prijs €
715918760	5918760	50000	80	60	ZSM405	50000 x 80 x 0	133,00
715918780	5918780	50000	80	80	ZSM405	50000 x 80 x 0	122,00
715918710	5918710	50000	80	100	ZSM405	50000 x 80 x 0	117,00
715918712	5918712	50000	80	120	ZSM405	50000 x 80 x 0	117,00
715918715	5918715	50000	80	150	ZSM405	50000 x 80 x 0	117,00
715918718	5918718	50000	80	180	ZSM405	50000 x 80 x 0	117,00
715918722	5918722	50000	80	220	ZSM405	50000 x 80 x 0	117,00



Universele schuurband voor de houtbewerking

100x915

Troeven:

- Breedte 100 mm x lengte 915 mm
- Verschillende korrels mogelijk: 60 - 80 - 100 - 120 - 150
- Linnendrager
- Aluminium oxide
- Uitstekende prijs-kwaliteitsverhouding

Geschikt voor:

- algemeen houtwerk
- het bewerken van randen en gelijke afname
- Holzstar BTS 150 of slijpmachines met gelijke maatvoering.

Tip: dienen per korrelsoort per 10 stuks aangekocht te worden

Order nr.	Orig. nr.	Lengte mm	Breedte mm	Korrel K	Type	VE	Min. bestelhoeveelheid	Afmetingen (l x b x h) mm	Prijs/VE €
715911006	5911006	915	100	60	BTS150	1	10	915 x 100 x 1	5,80
715911008	5911008	915	100	80	BTS150	1	10	915 x 100 x 1	5,70
715911010	5911010	915	100	100	BTS150	1	10	915 x 100 x 1	5,70
715911012	5911012	915	100	120	BTS150	1	10	915 x 100 x 1	5,60
715911015	5911015	915	100	150	BTS150	1	10	915 x 100 x 1	5,60



Universele schuurband voor de metaal- en houtbewerking

100x1000

Troeven:

- Breedte 100 mm x lengte 1000 mm
- Verschillende korrels mogelijk: 40 - 80
- Linnendrager
- Aluminium oxide
- Uitstekende prijs-kwaliteitsverhouding

Geschikt voor:

- algemeen metaal en houtwerk
- het bewerken van randen en gelijke afname
- Voor alle slijpmachines met gelijke maatvoering.

Tip: dienen per korrelsoort per 10 stuks aangekocht te worden

Order nr.	Orig. nr.	Lengte mm	Breedte mm	Korrel K	Prijs €
744591020	SB1001000K40	1000	100	40	5,70
744591030	SB1001000K80	1000	100	80	5,40



Universele schuurband voor de metaal- en houtbewerking

100x1220

Troeven:

- Breedte 100 mm x lengte 1220 mm
- Verschillende korrels mogelijk: 40 - 60 - 80 - 120
- Linnendrager
- Aluminium oxide
- Uitstekende prijs-kwaliteitsverhouding

Geschikt voor:

- algemeen metaal en houtwerk
- het bewerken van randen en gelijke afname
- MBSM101 of slijpmachines met gelijke maatvoering.

Tip: dienen per korrelsoort per 10 stuks aangekocht te worden

Order nr.	Orig. nr.	Lengte mm	Breedte mm	Korrel K	Voor type	VE	Min. bestelhoeveelheid	Afmetingen (l x b x h) mm	Prijs/VE €
713726040	3726040	1220	100	40	Metalkraft MBSM101-130	1	10	100 x 1220 x 0	5,80
713726060	SSK	1220	100	60	Metalkraft MBSM101-130	1	10	100 x 1220 x 0	5,60
713726080	3726080	1220	100	80	Metalkraft MBSM101-130	1	10	100 x 1220 x 0	5,50
713726120	3726120	1220	100	120	Metalkraft MBSM101-130	1	10	100 x 1220 x 0	5,40

100x1220



Industriële schuurband met een sterke Zirkonium korrel op een linnen drager.

Eigenschappen:

- Linnen drager
- Sterke Zirkonium korrel
- Kleur band : blauw

Voordelen:

- Agressief en constant slijpend
- Zeer goede verspaning op de meeste staalsoorten
- Lange levensduur

Geschikt voor:

- Alle bandschuurmachines met afmetingen 1220x100 mm
- MBSM101 en MBSM103

Order nr.	Orig. nr.	Lengte mm	Breedte mm	Korrel K	VE	Min. bestelhoeveelheid	Afmetingen (l x b x h) mm	Prijs/VE €
790700304	SBZ340	1220	100	40	1	10	1220 x 100 x 0	5,80
790700306	SBZ360	1220	100	60	1	10	1220 x 100 x 0	5,60
790700308	SBZ380	1220	100	80	1	10	1220 x 100 x 0	5,50
790700312	SBZ3120	1220	100	120	1	10	1220 x 100 x 0	5,40



Universele schuurband voor de metaal- en houtbewerking

100x2000

Troeven:

- Breedte 100 mm x lengte 2000 mm
- Verschillende korrels mogelijk: 40 - 60 - 120
- Linnendrager
- Aluminium oxide
- Uitstekende prijs-kwaliteitsverhouding

Geschikt voor:

- algemeen metaal en houtwerk
- het bewerken van randen en gelijke afname
- KRBS101 of slijpmachines met gelijke maatvoering.

Tip: dienen per korrelsoort per 10 stuks aangekocht te worden

Order nr.	Orig. nr.	Lengte mm	Breedte mm	Korrel K	Type	VE	Min. bestelhoeveelheid	Afmetingen (l x b x h) mm	Prijs/VE €
713722640	3722640	2000	100	40	staal	1	10	100 x 2000 x 0	6,90
713722660	3722660	2000	100	60	staal	1	10	100 x 2000 x 0	6,40
713722612	3722612	2000	100	120	staal	1	10	100 x 2000 x 0	6,00



Industriële schuurband met een sterke Zirkonium korrel op een linnen drager.

100x2000

Eigenschappen:

- Linnen drager
- Sterke Zirkonium korrel
- Kleur band : blauw

Voordelen:

- Agressief en constant slijpend
- Zeer goede verspaning op de meeste staalsoorten
- Lange levensduur

Geschikt voor:

- Alle bandschuurmachines met afmetingen 2000x100 mm
- RPSM, KRBS101

Order nr.	Orig. nr.	Lengte mm	Breedte mm	Korrel K	VE	Min. bestelhoeveelheid	Afmetingen (l x b x h) mm	Prijs/VE €
744591204	SBZ440	2000	100	40	1	10	100 x 2000 x 0	8,90
744591206	SBZ460	2000	100	60	1	10	100 x 2000 x 0	7,90
744591212	SBZ4120	2000	100	120	1	10	100 x 2000 x 0	6,90

MACHINES

Schuurbanden & schijven



Universele schuurband voor de houtbewerking

150x1220



Troeven:

- Breedte 150 mm x lengte 1220 mm
- Verschillende korrels mogelijk: 60 - 80 - 100 - 120 - 150
- Linnendrager
- Aluminium oxide
- Uitstekende prijs-kwaliteitsverhouding

Geschikt voor:

- algemeen houtwerk
- het bewerken van randen en gelijke afname
- Holskraft BTS200, Holzstar BTS250 of slijpmachines met gelijke maatvoering.

Tip: dienen per korrelsoort per 10 stuks aangekocht te worden

Order nr.	Orig. nr.	Lengte mm	Breedte mm	Korrel K	Type	VE	Min. bestelhoeveelheid	Afmetingen (l x b x h) mm	Prijs/VE €
715911206	5911206	1220	150	60	BTS200 BTS250	1	10	1219 x 150 x 1	9,30
715911208	5911208	1220	150	80	BTS200 BTS250	1	10	1219 x 150 x 1	9,00
715911210	5911210	1220	150	100	BTS200 BTS250	1	10	1219 x 150 x 1	7,80
715911212	5911212	1220	150	120	BTS200 BTS250	1	10	1219 x 150 x 1	7,70
715911218	5911218	1220	150	150	BTS200 BTS250	1	10	1219 x 150 x 1	7,70



Universele schuurband voor de metaal- en houtbewerking

150x2000



Troeven:

- Breedte 150 mm x lengte 2000 mm
- Verschillende korrels mogelijk: 40 - 60 - 80 - 120
- Linnendrager
- Aluminium oxide
- Uitstekende prijs-kwaliteitsverhouding

Geschikt voor:

- algemeen metaal en houtwerk
- het bewerken van randen en gelijke afname
- Optimum BSM150, Metallkraft MBSM150, MW-Mach BS150200 of slijpmachines met gelijke maatvoering.

Tip: dienen per korrelsoort per 10 stuks aangekocht te worden

Order nr.	Orig. nr.	Lengte mm	Breedte mm	Korrel K	VE	Min. bestelhoeveelheid	Afmetingen (l x b x h) mm	Prijs/VE €
713357672	3357672	2000	150	40	1	10	150 x 2000 x 0	12,50
713357674	3357674	2000	150	60	1	10	150 x 2000 x 0	12,50
713357676	3357676	2000	150	80	1	10	150 x 2000 x 0	11,90
713357678	3357678	2000	150	120	1	10	150 x 2000 x 0	11,50



Universele schuurband voor de houtbewerking

152x2010



Troeven:

- Breedte 152 mm x lengte 2010 mm
- Verschillende korrels mogelijk: 60 - 80 - 100 - 120 - 150 - 180 - 220
- Linnendrager
- Aluminium oxide
- Uitstekende prijs-kwaliteitsverhouding

Geschikt voor:

- algemeen houtwerk
- het bewerken van randen en gelijke afname
- Holzstar KSO 790 of slijpmachines met gelijke maatvoering.

Tip: dienen per korrelsoort per 10 stuks aangekocht te worden

Order nr.	Orig. nr.	Lengte mm	Breedte mm	Korrel K	Type	VE	Min. bestelhoeveelheid	Afmetingen (l x b x h) mm	Prijs/VE €
715917560	5917560	2010	152	60	KSO 790	1	10	2010 x 152 x 0	12,90
715917580	5917580	2010	152	80	KSO 790	1	10	2010 x 152 x 0	12,90
715917510	5917510	2010	152	100	KSO 790	1	10	2010 x 152 x 0	11,90
715917512	5917512	2010	152	120	KSO 790	1	10	2010 x 152 x 0	11,90
715917515	5917515	2010	152	150	KSO 790	1	10	2010 x 152 x 0	11,90
715917518	5917518	2010	152	180	KSO 790	1	10	2010 x 152 x 0	11,90
715917522	5917522	2010	152	220	KSO 790	1	10	2010 x 152 x 0	11,90

Holzstar



Universele schuurband voor de houtbewerking

152x2515

Troeven:

- Breedte 152 mm x lengte 2515 mm
- Verschillende korrels mogelijk: 60 - 80 - 100 - 120 - 150 - 180 - 220
- Linnendrager
- Aluminium oxide
- Uitstekende prijs-kwaliteitsverhouding

Geschikt voor:

- algemeen houtwerk
- het bewerken van randen en gelijke afname
- Holzstar KSO 850 of slijpmachines met gelijke maatvoering.

Tip: dienen per korrelsoort per 10 stuks aangekocht te worden

Order nr.	Orig. nr.	Lengte mm	Breedte mm	Korrel K	Type	VE	Min. bestelhoeveelheid	Afmetingen (l x b x h) mm	Prijs/VE €
715918560	5918560	2515	152	60	KSO 850	1	10	2515 x 152 x 0	12,90
715918580	5918580	2515	152	80	KSO 850	1	10	2515 x 152 x 0	12,90
715918510	5918510	2515	152	100	KSO 850	1	10	2515 x 152 x 0	12,90
715918512	5918512	2515	152	120	KSO 850	1	10	2515 x 152 x 0	12,90
715918515	5918515	2515	152	150	KSO 850	1	10	2515 x 152 x 0	12,90
715918518	5918518	2515	152	180	KSO 850	1	10	2515 x 152 x 0	12,90
715918522	5918522	2515	152	220	KSO 850	1	10	2515 x 152 x 0	12,90

OPTIMUM



Grafielbanden voor bandschuurmachines

Troeven:

- Bescherm laag tussen machine en schuurband

Geschikt voor:

- alle bandschuurmachines met een zelfde horizontaal schuurvlak
- MWMach BS75200 en BS150200, Metallkraft MBSM75 en MBSM150

Order nr.	Orig. nr.	Breedte mm	Voor type	Afmetingen (l x b x h) mm	Prijs €
713722128	GB82470	75	BS75 / MBSM75	450 x 82 x 0,5	10,50
713722080	GB150	150	BS150 / MBSM150	610 x 150 x 0,5	16,50

MACHINES

Staalborstels

HA



Rondborstels voor slijpmolens.

Troeven:

- Messing gecoate stalen draden

Geschikt voor:

- algemene werkzaamheden
- montage op slijpmolens

Geleverd met:

- flensringen 12.7mm, 15.887mm, 19.05mm, 22.225mm en 25.4mm.

Order nr.	Orig. nr.	Diameter mm	Diamètre fil d'acier mm	Asgat mm	Voor type	Toerental tpm	Prijs €
724581180	HA5440623008	150 x 25	0.3	32	GU15 ME15	6000	8,60
724581185	HA5540623008	178 x 25	0.3	32	GU18	6000	0,00
724581190	HA5660623008	200 x 25	0.3	32	GU20 ME20	4500	10,50
724581195	HA5760623008	250 x 25	0.3	32	GU25	4000	13,50

Schuurschijven



SLIJPSTEN EN POLIERSCHIJVEN

p. 863

Velcro basisschijven

Troeven:

- Eenvoudig en snel wisselen van schuurschijven
- Tijdswinst

Geschikt voor:

- voor metaal als houtbewerkingsmachines

Wenst u nog vlugger te kunnen werken?

- Opteer dan voor de scheidingsplaat (BTS250), hiermee kunt u nog vlugger schuurschijven wisselen zonder deze te scheuren.



Order nr.	715911001 ^M	715912501 ^M	713357801 ^M
Orig. nr.	5911001	5912501	3357801
Diameter	150	250	300
Voor type	BTS150 DBS75 BTS51	BTS250	TS305 BTS200
Afmetingen (l x b x h)	mm	mm	305 x 305 x 2
Prijs	€ 9,30	13,90	21,90

OPTIMUM

Velcro schuurschijf. Aluminiumoxide korrel.

Geschikt voor:

- Voor algemeen gebruik voor metaal en hout.
- Voor bandschuurmachines Optimum DBS75, Metallkraft BTS50/51, Quantum TS305, Holzkraft BTS200 en andere bandschuurmachines die werken met een velcro schijf van diameter 150 of 300 mm.

Kenmerken:

- Met Velcro bevestigingslaag voor een snelle en gemakkelijke schijfwissel.

Minimum bestelhoeveelheid: 5 stuks.

Order nr.	Orig. nr.	Omschrijving	Korrel K	Voor type	Diameter mm	VE	Min. bestelhoeveelheid	Afmetingen (l x b x h) mm	Prijs/VE €
713357832 ^M	3357832	Schuurschijf	40	DBS75 BTS51	1	1	5	150 x 150 x 2	1,50
713357834 ^M	3357834	Schuurschijf	60	DBS75 BTS51	1	1	5	150 x 150 x 2	1,50
713357836 ^M	3357836	Schuurschijf	80	DBS75 BTS51	1	1	5	150 x 150 x 2	1,50
713357838 ^M	3357838	Schuurschijf	120	DBS75 BTS51	1	1	5	150 x 150 x 2	1,50
713357854 ^M	3357854	Schuurschijf	40	TS305	1	1	5	305 x 305 x 2	3,30
713357856 ^M	3357856	Schuurschijf	60	TS305	1	1	5	305 x 305 x 2	3,30
713357858 ^M	3357858	Schuurschijf	80	TS305	1	1	5	305 x 305 x 2	3,10
713357860 ^M	3357860	Schuurschijf	100	TS305	1	1	5	305 x 305 x 2	3,10
713357862 ^M	3357862	Schuurschijf	120	TS305	1	1	5	305 x 305 x 2	3,10
713357865 ^M	3357865	Schuurschijf	150	TS305	1	1	5	305 x 305 x 2	3,10

MACHINES



Schuurschijven voor houtbewerking

Troeven:

- Breed gamma van korrels voor diverse afwerkingen
- Met velcro zijde om eenvoudig en snel te wisselen

Geschikt voor:

- voor Holzstar schuurmachines BTS 150 (ø150) en 250 (ø250).
- Andere toestellen met een identieke diameter

Opgepast:

- Vergeet uw basis velcroschijf niet bij te bestellen om deze schuurschijven te kunnen gebruiken



Order nr.	Omschrijving	Korrel K	Voor type	VE	Min. bestelhoeveelheid	Prijs/VE €
715911506 ^M	klitschijf 150mm	60	BTS150	1	10	1,80
715911508 ^M	klitschijf 150mm	80	BTS150	1	10	1,60
715911510 ^M	klitschijf 150mm	100	BTS150	1	10	1,60
715911512 ^M	klitschijf 150mm	120	BTS150	1	10	1,60
715911515 ^M	klitschijf 150mm	150	BTS150	1	10	1,60
715912506 ^M	klitschijf 250mm	60	BTS200/250	1	10	3,60
715912508 ^M	klitschijf 250mm	80	BTS200/250	1	10	3,60
715912510 ^M	klitschijf 250mm	100	BTS200/250	1	10	3,50
715912512 ^M	klitschijf 250mm	120	BTS200/250	1	10	3,50
715912515 ^M	klitschijf 250mm	150	BTS200/250	1	10	3,30



5 414919 976588